

DEPARTMENT OF THE ARMY TECHNICAL BULLETIN
CALIBRATION PROCEDURE FOR
CALIBRATION ADAPTER,
TEKTRONIX TYPES TU-7, IMI,
067-0521-00, AND 067-0521-01

Headquarters, Department of the Army, Washington, D. C.
28 May 1980

TB 9-4931-444-35, 28 September 1976, is
changed as follows:

(Item B9, second column) Add superscript
"3" after "TEST LEAD."

Page 4, table 3. (Item B2, second column) Add
"CALIBRATION FIXTURE" after "ADAPTER
CABLE."

Add item B31 at end of table as follows:

B11	ADAPTER	---	BNC plug to double banana jack (MS90578-1441	---
-----	---------	-----	---	-----

Page 7. Supersede paragraph 13b as follows:

b. In accordance with TNI 38-750, annotate and
affix DA Label 80 (US Army Calibrated Instrument).
When the TI receives limited or special calibration,
annotate and affix DA Label 163 (US Army Limited or
Special Calibration). When the TI cannot be adjusted
within tolerance, annotate and affix DA Form 2417 (US
Army Calibration System Rejected Instrument).

Page 8. Supersede paragraph 19a(6) as follows:

(6) Disconnect lead (B9) from calibration fixture (B2)
GAIN jack and connect to TI EXT

INPUT, using adapter (B11). Set TI TEST FUNCTION
switch to GAIN SET.

Page 11. Supersede paragraph 26b as follows:

b. In accordance with TM 38-750, annotate and affix
DA Label 80 (US Army Calibrated Instrument). When
the TI receives limited or special calibration, annotate
and affix DA Label 163 (US Army Limited or Special
Calibration). When the TI cannot be adjusted within
tolerance, annotate and affix DA Form 2417 (US Army
Calibration System Rejected Instrument).

By Order of the Secretary of the Army:

E. C. MEYER
General, United States Army
Chief of Staff

J. C. PENNINGTON
Major General, United States Army
The Adjutant General

Distribution:

To be distributed in accordance with DA Form 12-34A. (qty rqr block No. 75), requirements for calibration procedures publications.

DEPARTMENT OF THE ARMY TECHNICAL BULLETIN
CALIBRATION PROCEDURE FOR
CALIBRATION ADAPTER,
TEKTRONIX TYPES TU-7, 1M1,
067-0521-00, AND 067-0521-01

Headquarters, Department of the Army, Washington, D.C.
3 March 1978

TB 9-4931-444-35, 28 September 1976, is changed as follows:

Page 8, paragraph 23ta(4), line 3. Change "5.6 centimeters or greater" to read "2.8 centimeters or less."

By Order of the Secretary of the Army:

Official:

J. C. PENNINGTON
Brigadier General, United States Army
The Adjutant General

BERNARD W. ROGERS
General, United States Army
Chief of Staff

Distribution:

To be distributed in accordance with DA Form 12-34A, Requirements for Calibration Procedures Publications.

DEPARTMENT OF THE ARMY TECHNICAL BULLETIN
CALIBRATION PROCEDURE FOR
CALIBRATION ADAPTER,
TEKTRONIX TYPES TU-7, 1M1,
067-0521-00 AND 067-0521-01

Headquarters, Department of the Army, Washington, DC
26 August 1977

TB 9-4931-444-35, 28 September 1976, is changed as follows:

Page 3, table 2. Under Minimum Use Specifications column for Item A3, change "Must be compatible T1" to read "Range: 200 to 560 mV, 1 ms to 2 us; Accuracy: +3%."

Page 4, paragraph 7. Delete subparagraph b.

By Order of the Secretary of the Army:

Official:

PAUL T. SMITH
Major General, United States Army
The Adjutant General

BERNARD W. ROGERS
General, United States Army
Chief of Staff

Distribution:

To be distributed in accordance with DA Form 12-34A, requirements for Calibration Procedures Publications.

**DEPARTMENT OF THE ARMY TECHNICAL BULLETIN
CALIBRATION PROCEDURE FOR
CALIBRATION ADAPTER,
TEKTRONIX TYPES TU-7, 1M1,
067-0521-00 AND 067-0521-01**

**Headquarters, Department of the Army, Washington, DC
8 April 1977**

TB 9-4921-444-35, 28 September 1976, is changed as follows:

Page 5, figure 1. A4 and A5 are deleted from the illustration. B5 is changed to "B3."

By Order of the Secretary of the Army:

Official:

PAUL T. SMITH
*Major General, United States Army
The Adjutant General*

BERNARD W. ROGERS
*General, United States Army
Chief of Staff*

Distribution:

To be distributed in accordance with DA Form 12-34A, Requirements for Calibration Procedures Publications.

**DEPARTMENT OF THE ARMY TECHNICAL BULLETIN
CALIBRATION PROCEDURE FOR
CALIBRATION ADAPTER,
TEKTRONIX TYPES TU-7, 1M1,
067-0521-00, AND 067-0521-01**

**Headquarters, Department of the Army, Washington, D. C.
28 September 1976**

REPORTING OF ERRORS

You can help improve this publication by calling attention to errors and by recommending improvements and stating your reasons for the recommendations. Your letter or DA Form 2028, Recommended Changes to Publications and Blank Forms, should be mailed directly to Commander, US Army Missile Command, ATTN: DRSMI-MFPA, Redstone Arsenal, AL 35809. A reply will be mailed directly to you.

	Paragraph	Page
Section I.	IDENTIFICATION AND DESCRIPTION	
	Test instrument identification	2
	Calibration data card, DA Form 2416.....	2
	Calibration description.....	2
Section II.	EQUIPMENT REQUIREMENTS	
	Equipment required	3
	Accessories required.....	3
Section III.	PRELIMINARY OPERATIONS (LEVEL A)	
	Preliminary instructions	4
	Equipment setup	4
Section IV.	CALIBRATION PROCESS (LEVEL A)	
	Gain set.....	5
	Drive balance and pulse dc level.....	5
	Pulse repetition rate	6
	Amplitude control.....	7
	Pulse rise time.....	7
	Final procedure	7
Section V.	PRELIMINARY OPERATIONS (LEVEL C)	
	Preliminary instructions	7
	Equipment setup	7
Section VI.	CALIBRATION PROCESS (LEVEL C)	
	+ 225V output.....	7
	Variable control	8
	Vertical position	8
	Gain set.....	8
	Common mode.....	8
	Alternate mode	8

*This bulletin supersedes TB 9-4931-444-35, 11 January 1974, including all changes.

	Paragraph	Page
Chopped mode	22	8
Pulse amplitude	23	8
Pulse repetition rate (S/N 3994 and below).....	24	10
Pulse repetition rate (SIN 3995 and above)	25	10
Final procedure	26	11

**SECTION I
IDENTIFICATION AND DESCRIPTION**

1. Test Instrument Identification

This bulletin provides instructions for the calibration of Calibration Adapter, Tektronix Types TU-7, 1MI, 067-0521-00, and 067-0521-01. The manufacturer's instruction manuals were used as the prime data source in compiling these instructions. Sections I and II provide instructions for all levels of calibration. Sections III and IV pertain to level A only, and sections V and VI apply to level C only. The equipment being calibrated will be referred to as the 'T' (test instrument) throughout this bulletin.

a. Model Variations. All calibration adapters listed above are electrically similar instruments. The designator of TU-7 becomes type IMI at S/N 500. IMI becomes type 067-0521-00 at S/N 1387, and 067-0521-00 becomes type 067-0521-01 at S/N 4000. On type 067-0521-01, the REPETITION RATE (LOW, MED, HIGH) switch is replaced with a five-position (1, 4, 15, 80, and 500 kHz) switch. Some types use a UHF connector for the EXT INPUT.

b. Time and Technique. The time required for this calibration is approximately 2 hours, using the dc and low frequency technique.

2. Calibration Data Card, DA Form 2416

a. Forms, records, and reports required for calibration personnel at all levels are prescribed by TM 38-750, DA Form 2416 must be annotated in accordance with TM 38-750 for each calibration performed.

b. Adjustments to be reported on DA Form 2416 are designated ® at the end of the sentence in which they appear. When adjustments are in tables, the ® will follow the designated adjustment. Report only those adjustments made and designated with ®.

3. Calibration Description

TI parameters and performance specifications which pertain to this calibration are listed in table 1.

Table 1. Calibration Description

Test Instrument Parameters	Performance Specifications
Power input requirements	Supplied by Tektronix oscilloscope series 530, 540, and 550
Variable control'	Range: 0.5-v p-p signal must be variable from 0 to 0.6 cm or more
Chopped rate'	Range: 100 kHz; accuracy ±25%. Signal applied to EXT INPUT attenuated approx 1000 times.
+ and - pulse amplitude max of vert display.	Range: No more than 3 cm amplitude at min, or no less than 5.5 cm amplitude at
Repetition rate	Range: Low, 5 kHz ±25%; medium, 100 kHz +20% for S/N 1409 to 3999 or 120 kHz ±20% for SIN 100 to 1408; high, 600 kHz ±20%. S/N 4000 and above has a 5-position range switch.
Overshoot ringing	Range: 4-cm display; accuracy ±2% of total height of square wave
Gain	Range: Input signal ratio of 250:1; accuracy, ±1%
Rise time	3 nsec or less
Amplitude	Adjusts amplitude of pulse applied to oscilloscope vert ampl when TEST FUNCTION switch is set to + PULSE or -PULSE.
Vertical position	Controls vert position of trace or display on crt in all TEST FUNCTION positions except COMMON MODE.
+ 225V pushbutton	Provides + 225 v at front panel output
+ 225V (banana jack)	+ 225 v source for checking dc bal of each state of distributed vert ampl. Accuracy, ±2%.

'This specification is for information only and is not verified in this bulletin.

**SECTION II
EQUIPMENT REQUIREMENTS**

4. Equipment Required

Table 2 identifies the specific equipment used in this calibration procedure. This equipment is issued with secondary transfer standards calibration sets NSN 6695-00-621-7877, AN/GSM-256 NSN 4931-00-525-8175, AN/GSM-259' NSN 4931-01-019-1829, and transportable maintenance calibration facility ANfSM-55(), and electronic shop set TOE 29-134H and is to be used in performing this procedure. Alternate items may be used by the calibrating activity when the equipment listed in table 2 is not available. The items selected must be verified to perform satisfactorily prior to use and must bear evidence of current calibration. The equipment must

meet or exceed the minimum use specifications listed in table 2. The accuracies listed in table 2 provide a four-to-one accuracy ratio between the standard and TI. Where the four-to-one ratio cannot be met, the actual accuracy of the equipment selected is shown in parenthesis.

5. Accessories Required

The accuracies listed in table 3 are issued as indicated in paragraph 4 above and are to be used in this calibration procedure. When necessary, these items may be substituted by equivalent items unless specifically prohibited.

Table 2. Minimum Specifications of Equipment Required

Item	Common Name	Minimum Use Specifications:	Manufacturer, Model, and Part Number	
			Level A	AN/GSM-256, AN/CSM-259, and AN/TSMJS
A1	AUTOTRANSFORMER	Range: 105 to 125 vac Accuracy: ±3%	---	General Radio, Model W10OMT3AS3 (TF-510/U) (7910809).
A2	DC VOLTMETER	Range: 393 mv to 70 vdc Accuracy: +0.25%	Dana, Model 5703-S-2127 (7912606)	John Fluke, Model 883AB (TS-2843/U) or John Fluke, Model 887ABAN (MIS-10216).
A3	OSCILLOSCOPE	Must be compatible TI	Tektronix, Type RM56 IA (7910655-2) w/plug-ins 3A6 (791144 1-1) and 3B3 (7911437-1).	Tektronix, Type 545A/B (must be provided with TI).
A4	PLUG-IN UNIT	Range: 50 to 200 mv Accuracy: ± 3%	Tektronix, Type 3S76 (7910657-1).	-
A5	PLUG-IN UNIT	Range: 1 to 3 nsec Accuracy: +3%	Tektronix, Type 3T77 (7910656-1).	--
A6	RATIO TRANSFORMER	Range: 0.00400 to 1.01000	---	Gertsch, Model RT60 (TF-5 15/U).
A7	TEST OSCILLOSCOPE	Range: 600 kHz bandwidth	---	Tektronix, Type 453 (AN/USM-273) w/X10 probe Tektronix, Type 010-0 1884-00; and Hewlett-Packard, Model 180D. ¹
A8	VOLTAGE STANDARD	Range: 100 mv to 100 vdc Accuracy: ±0.25% ²	John Fluke, Model 332A (7911393)	John Fluke, Model 760A (TS-2734/U).

¹±0.5% for AN/GSM-256 and AN/TSM-55

²For AN/CSM-256 only

³±0.3% for AN/GSM-256 and AN/TSM-55

¹Not fielded as of the date of this bulletin

Table 3. Accessories Required

Item	Common Name	Description, Model, and/or Part Number		
		Level A	AN/TSM-55	AN/GSM-256 and AN/GSM-259
B1	ADAPTER ¹	BNC plug terminations (MS35 1 76-49 1 B)	BNC jack to UHF plug; Amphenol, Model UG-273/U.	BNC jack to UHF plug (10519439).
B2	ADAPTER CABLE	Calibration fixture (7913230)	Tektronix, Type 013-005; gain adjust MX-7774/U.	---
B3	ADAPTER ²	BNC jack to GR connector (MS75093),	---	BNC plug to double
B4	ADAPTER	Single banana jack to alligator clip (black) (7907560).	---	Single banana jack to
B5	CABLE ³	36-in., RG-58/U; BNC plug to double banana plug (7907471)	18-in., RG-58C/U; BNC plug terminations; Pomona, Model BNC-C-18	30-in., RG-58/U; BNC plug terminations (7907467).
B6	CABLE	---	BNC plug to black and red banana plugs; Pomona, Model 2241-C-36.	Use B3 and B9 in lieu of B6.
B7	PROBE	32-in lead w/minature hook terminations (SKC-4850-14).	---	---
B8	TEST LEAD ²	---	36-in., double banana plug to black and red alligator clips; Pomona, a Model 2BCAL-36.	Use B9 in lieu of B8
B9	TEST LEAD -	---	24-in., single banana plug terminations (red); Pomona, Model B-24	24-in., single banana plug terminations (black) (7907498).
B10	TEST LEAD	---	36-in., single banana plug terminations; Pomona, Model B-36.	Use B9 in lieu of B10

¹Two required²Three required.³Four required

SECTION III PRELIMINARY OPERATIONS (LEVEL A)

6. Preliminary Instructions

a. The instructions outlined in this section are preparatory to the calibration process. Personnel should become familiar with sections I through IV before beginning the calibration.

b. Items of equipment used in this procedure are referenced within the text by common name and item identification number as listed in tables 2 and 3. For the identification of equipment referenced by item numbers prefixed with A, see table 2, and for prefix B, see table 3.

WARNING

HIGH VOLTAGE is used during the performance of

this calibration. DEATH ON CONTACT may result if personnel fail to observe safety precautions.

7. Equipment Setup

a. Position TI controls as listed in (1) through (3) below:

(1) VARIABLE, VERTICAL POSITION, and AMPLITUDE controls to midrange.

(2) TEST FUNCTION switch to GAIN SET.

(3) REPETITION RATE switch to 80 kHz (or MED).

b. Energize equipment and allow sufficient time for equipment to warm up.

SECTION IV CALIBRATION PROCESS (LEVEL A)

NOTE

Unless otherwise specified, verify the results of each test and take corrective action whenever the test requirement is not met before continuing with the calibration.

interconnecting plug and chassis ground, using leads supplied with dc voltmeter.

(4) Adjust voltage standard for a 100-volt dc output. Dc voltmeter will indicate between 396 and 404 millivolts.

5) Remove probe and adapter connected in (1) above.

b. Adjustments. No adjustments can be made.

8. Gain Set

a. Performance Check

(1) Connect pin 10 of interconnecting plug on TI to chassis ground, using probe and adapter (B7 and B4).

(2) Connect voltage standard (A8) to TI EXT INPUT, using cable (B5).

(3) Connect dc voltmeter (A2) between pin 1 of TI

9. Drive Balance and Pulse Dc Level

a. Performance Check

(1) Connect equipment as shown in figure 1.

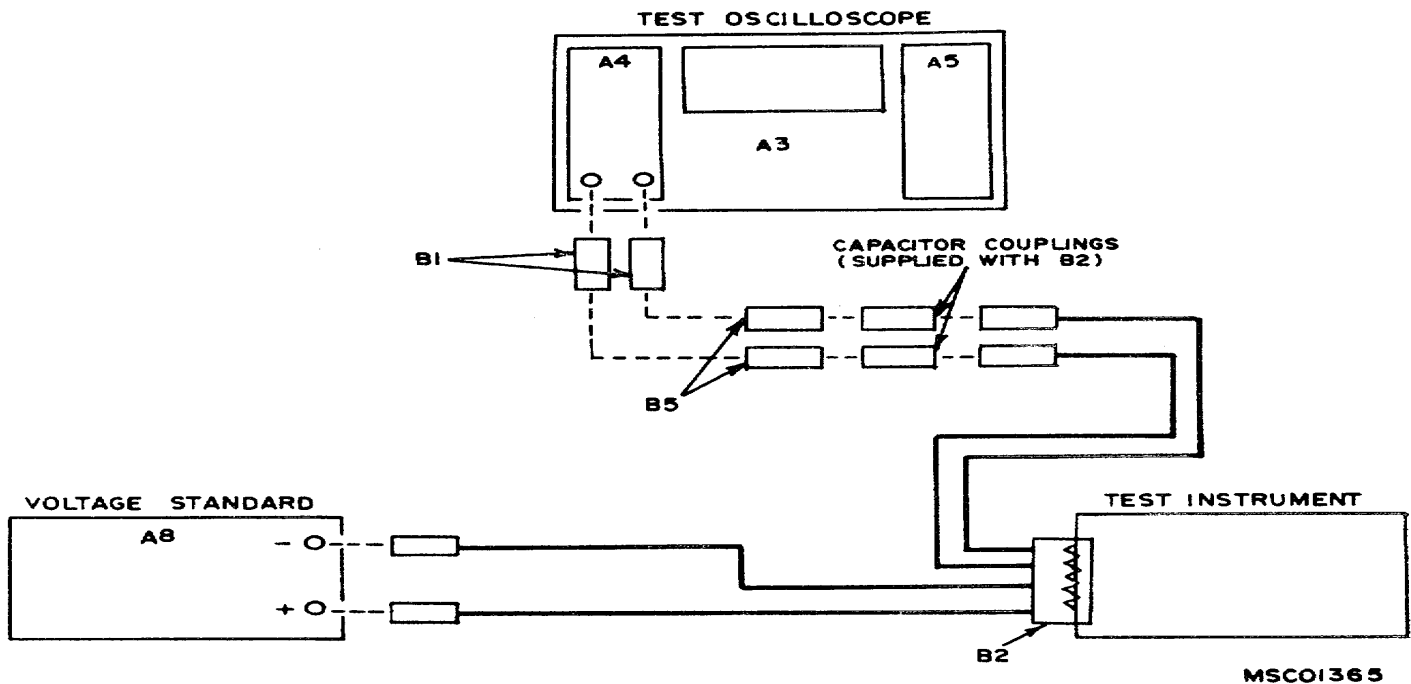

Figure 1. Calibration adapter - equipment setup.

(2) Position oscilloscope (A3) controls as listed in (a) through (h) below:

- (a) Both VOLTS/DIV switches to .1.
- (b) Both POSITION controls to midrange.
- (c) MODE switch to ALTER.
- (d) INV (CHI) NORM switch to NORM.
- (e) Both AC/DC/GND switches to DC.
- (f) Both VARIABLE controls to CALIB.
- (g) TIME/DIV switch to S ASEC.
- (h) TIME VARIABLE control to CALIB.

(3) Set TI TEST FUNCTION switch to + PULSE.

(4) Adjust voltage standard (A8) for a 95-volt dc output.

(5) Adjust TI AMPLITUDE control for 2 centimeters of vertical deflection on oscilloscope (A3) crt and adjust both POSITION controls to superimpose CH1 and CH2 signals. If signals cannot be adjusted for 2 divisions of superimposed (equal) amplitude, disregarding overshoot at leading and trailing edges, perform *b* (1) below.

(6) Connect dc voltmeter (.A2) to TI junction R41/R54 (fig. 2) and chassis ground. using probe (B7). If dc voltmeter does not indicate between 66.00 and 69.00 volts, perform *b(2)* and (3) below.

(7) Remove probe connected in (6) above.

b. Adjustments

(1) Adjust DRIVE BAL R40 (fig. 2) and both POSITION controls until CHI and CH2 signals are superimposed.

NOTE

If adjustment R40 does not superimpose signals, adjust oscilloscope POSITION controls to display separate waveforms and then adjust for equal amplitudes.

(2) .Adjust PULSE DC LEVEL R30 (fig. 2) until dc voltmeter indicates between 66.00 and 69.00 volts.

(3) Due to interaction of adjustments, repeat (1) and (2) abode for optimum results.

10. Pulse Repetition Rate

a. Performance check

(1) Turn TI AMPLITUDE control fully counterclockwise.

(2) Position TI REPETITION RATE switch and oscilloscope (A3) TIME/CM switch as listed in table 4. Oscilloscope will display waveforms within limits specified in table 4.

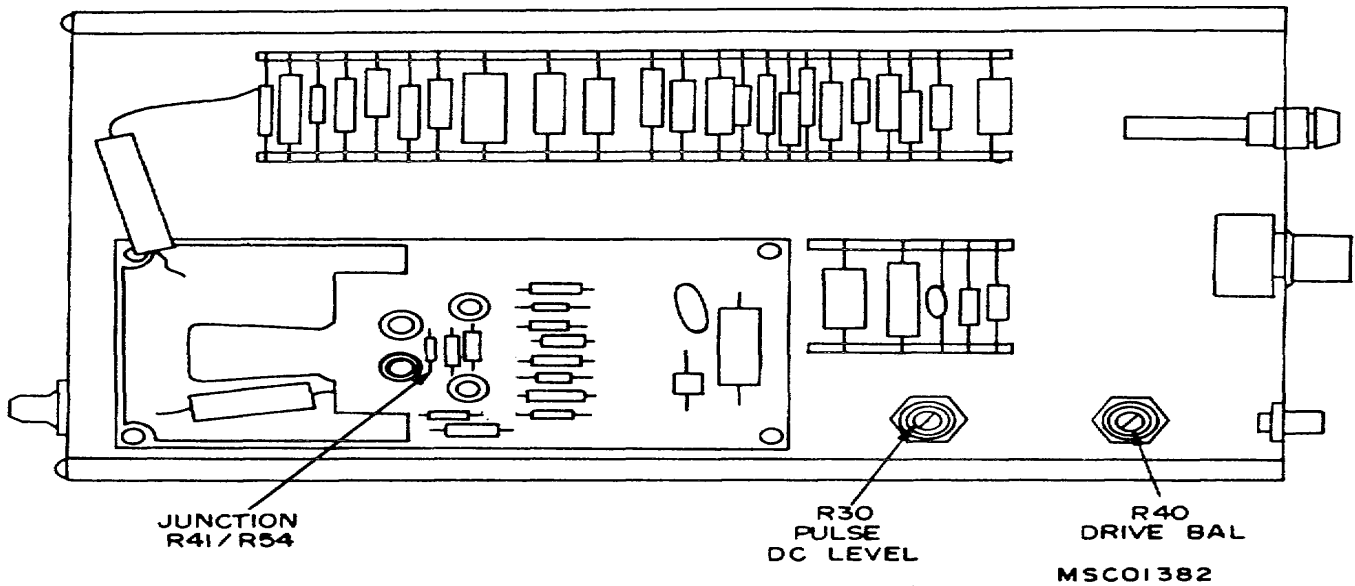

Figure 2. Calibration adapter - left side view.

Table 4. Repetition Rates

Test Instrument REPETITION RATE Switch Settings	Oscilloscope	
	TIME/CM Switch Settings	Cycles Per 10 Centimeters Display
1 kHz ¹	1 ms	7.5 to 12.5
4 kHz	.2 ms	.2 ms 6to 10
15kHz	50µs	5.6to9.4
80 kHz	10 µs	6to 10
500 kHz	2µs	7.5to 12.5
LOW ²	.2 ms	.2 ms 7.5 to 12.5 ³
MED ²	10µ s	9 to 154 ⁴
HIGH ²	2µs	9to 15

¹For types with S/N 3995 and above.

²For types with S/N 3995 and below.

³Display will be form 8 to 12 cycles for types with S/N 1409 and below.

⁴Display will be from 8 to 12 cycles for types with S/N between 1409 and 3995.

b. Adjustments No adjustments can be made.

11. Amplitude Control

a. Performance Check

(1) Turn TI REPETITION RATE switch to 500 kHz (HIGH).

(2) Position oscilloscope (A3) controls as listed in (a) through (c) below:

(a) MODE switch to ADDED and INV (CHI).

(b) Both VOLTS/DIV switches to .1 VOLTS.

(c) VARIABLE control to CALIB.

(3) Turn TI AMPLITUDE control fully clockwise. Oscilloscope will indicate at least 560 millivolts.

(4) Turn TI amplitude control fully counterclockwise.

Oscilloscope will indicate 280 millivolts or less.

b. Adjustments. No adjustments can be made.

12. Pulse Rise Time

a. Performance Check

(1) Remove oscilloscope (A3) plug-ins and insert plug-ins (A4 and AS) into left and right compartments, respectively.

(2) Position plug-in (A4) controls as listed in (a) through (f) below:

(a) NIODE switch to A+B.

(b) INTERNAL TRIGGER to A.

(c) A&B MV/DIV switches to 50.

(d) Both A&B 2-200 VAR switches to CALIB.

(e) Channel A NORM/INV switch to NORM.

(f) Channel B NORM/INV switch to INV.

(3) Position plug-in (A5) controls as listed in (a) through (f) below:

(a) TIME/DIV control to 1 nSEC.

(b) VARIABLE control to CALIB.

(c) HORIZ NMAG switch to XI.

(d) DOTS PER DIV switch to 10.

(e) SWEEP MODE switch to NORMAL.

(f) TRIGGER switch to +INT.

(4) Connect equipment as shown in figure 1, except for adapters (BI and B3).

(5) Turn TI REPETITION RATE switch to **050 kHz** (MED) and adjust AMPLITUDE control for 4 centimeters of vertical deflection on oscilloscope crt.

(6) Measure rise time, using standard rise-time techniques. Rise time will be 3 nanoseconds or less. Overshoot and ringing will be less than 2 percent of total height.

b. Adjustments. No adjustments can be made.

13. Final Procedure

a. Deenergize and disconnect all equipment.

b. In accordance with TM 38-750, annotate and affix DA Label 80 (US Army Calibration Stem). When the TI cannot be adjusted within tolerance, annotate and affix DA Form 2417 (Unserviceable or Limited Use) tag.

SECTION V

PRELIMINARY OPERATIONS (LEVEL C)

14. Preliminary Instructions

a. The instructions contained in this section are preparatory to the calibration process. Personnel should become familiar with sections I, II, V, and VI before beginning the calibration.

b. Items of equipment used in this procedure are referenced within the text by common name and item identification number as listed in tables 2 and 3. For the identification of equipment referenced by item numbers prefixed with A, see table 2 and for prefix B, see table 3.

WARNING

HIGH VOLTAGE is used during the performance of this calibration. DEATH ON CONTACT may result if personnel fail to observe safety precautions.

15. Equipment Setup

a. Install TI in oscilloscope (A3) and connect oscilloscope to auto-transformer (AI).

b. Connect autotransformer to a 115-volt ac source and adjust controls for a 115-volt output.

c. Energize equipment and allow sufficient time for warmup.

d. Position TI controls as listed in (1) through (5) below:

(1) TEST FUNCTION switch to LOW LOAD.

(2) REPETITION RATE switch to MED (or 80 kHz).

(3) VARIABLE control to midrange.

(4) AMPLITUDE control to midrange.

(5) VERTICAL POSITION control to midrange.

e. Position oscilloscope controls as listed in (1) through (4) below:

(1) HORIZONTAL DISPLAY switch to A.

(2) TIME BASE A TIME/CM switch to 1 mSEC.

(3) TRIGGERING MODE switch to AUTO.

(4) TRIGGER SLOPE switch to + INT.

SECTION VI

CALIBRATION PROCESS (LEVEL C)

NOTE

Unless otherwise specified, verify the result of each test and take corrective action whenever the test requirement is not met before continuing with the calibration.

16. +225 V Output

a. Performance Check

(1) Connect de voltmeter (A2) between TI +225V jack and chassis ground, using test leads (B9).

- (2) Depress and hold 1T +225V pushbutton. Dc voltmeter will indicate between 220.5 and 229.5 volts dc.
 (3) Release pushbutton and disconnect dc voltmeter.
b. Adjustments. No adjustments can be made.

17. Variable Control

a. Performance Check

- (1) Connect oscilloscope (A3) CAL OUT to TI EXT INPUT, using cable and adapter (B5 and BI) as required.
 (2) Set oscilloscope AMPLITUDE CALIBRATOR switch to .5 VOLTS.
 (3) Turn TI VARIABLE control fully clockwise. Oscilloscope crt will display square wave with amplitude .6 centimeter or greater.
 (4) Turn TI VARIABLE control fully counterclockwise. Oscilloscope will display a single trace on crt.
b. Adjustments. No adjustments can be made.

18. Vertical Position

a. Performance Check

- (1) Set Oscilloscope (A3) AMPLITUDE CALIBRATOR switch to 10 VOLTS.
 (2) Adjust TI VARIABLE control for oscilloscope crt square-wave display 6 centimeters in amplitude.
 (3) Turn TI VERTICAL POSITION control fully clockwise and fully counterclockwise. Oscilloscope crt display will move completely off graticule in both directions.
b. Adjustments. No adjustments can be made.

19. Gain Set

a. Performance Check

NOTE

For users of AN/GSM-256 and AN/GSM-259 equipment, remove TI from oscilloscope (A3) and perform paragraphs 7 and 8 in sections III and IV above in lieu of paragraph 19. Use voltage standard (A8) and dc voltmeter (A2). After performing paragraphs 7 and 8, insert TI into oscilloscope and proceed to paragraph 20 below.

- (1) Set oscilloscope (A3) POWER switch to down (off) position.
 (2) Remove TI from oscilloscope and connect equipment as shown in figure 3.
 (3) Energize equipment and set ratio transformer (A6) decade dials to .00400.
 (4) Set voltage standard (AS) dials to 035.3500.
 (5) Adjust voltage standard frequency for 400 Hz and amplitude output for a 4-centimeter peak-to-peak display on oscilloscope crt.
 (6) Set TI TEST FUNCTION switch to GAIN SET.
 (7) Adjust ratio transformer decade dials for a 4-centimeter peak-to-peak display on oscilloscope crt. Ratio transformer will indicate between .99000 and X1000.

- b. Adjustments.* No adjustments can be made.

20. Common Mode

a. Performance Check

- (1) Set TI TEST FUNCTION switch to COMMON MODE.
 (2) Set oscilloscope (A3) AMPLITUDE CALIBRATOR switch to OFF.
 (3) Connect oscilloscope CAL OUT to TI EXT INPUT, using cable (B5).
 (4) Observe position of trace on oscilloscope crt and set AMPLITUDE CALIBRATOR switch to 1 VOLT. Display on crt will not vary by more than 1 centimeter.
b. Adjustments. No adjustments can be made.

21. Alternate Mode

a. Performance Check

- (1) Set TI TEST FUNCTION switch to ALTERNATE.
 (2) Position oscilloscope (A3) controls as listed in (a) through (c) below:
 (a) AMPLITUDE CALIBRATOR switch to 100 VOLTS.
 (b) TIME BASE A STABILITY control fully clockwise.
 (c) TIME BASE A TRIGGERING MODE switch to AC.
 (3) Set oscilloscope TIME/CM switch to all positions, in turn. Oscilloscope will display trace on crt as shown in figure 4.
b. Adjustments. No adjustments can be made.

22. Chopped Mode

a. Performance Check

- (1) Turn oscilloscope (A3) AMPLITUDE CALIBRATOR switch to OFF and TIME/CM switch to 10 NSEC.
 (2) Set TI TEST FUNCTION switch to CHOPPED.
 (3) Adjust oscilloscope controls for a stable display. Oscilloscope crt will display between 8 and 12 complete waveforms within 10 centimeters, as illustrated in figure 5.
 (4) Set oscilloscope CRT CATHODE SELECTOR switch (rear panel) to DUAL-TRACE CHOPPED BLANKING. Crt will display blanked rising and falling portions of waveform, as illustrated in figure 6.
b. Adjustments. No adjustments can be made.

23. Pulse Amplitude

a. Performance Check

- (1) Set oscilloscope (A3) CRT CATHODE SELECTOR switch to EXT CRT CATHODE and TIME/CM switch to 2 μ SEC.
 (2) Position TI controls as listed in (a) through (c) below:
 (a) REPETITION RATE switch to HIGH (or 500 kHz).
 (b) TEST FUNCTION switch to +PULSE.
 (c) AMPLITUDE control fully counterclockwise.

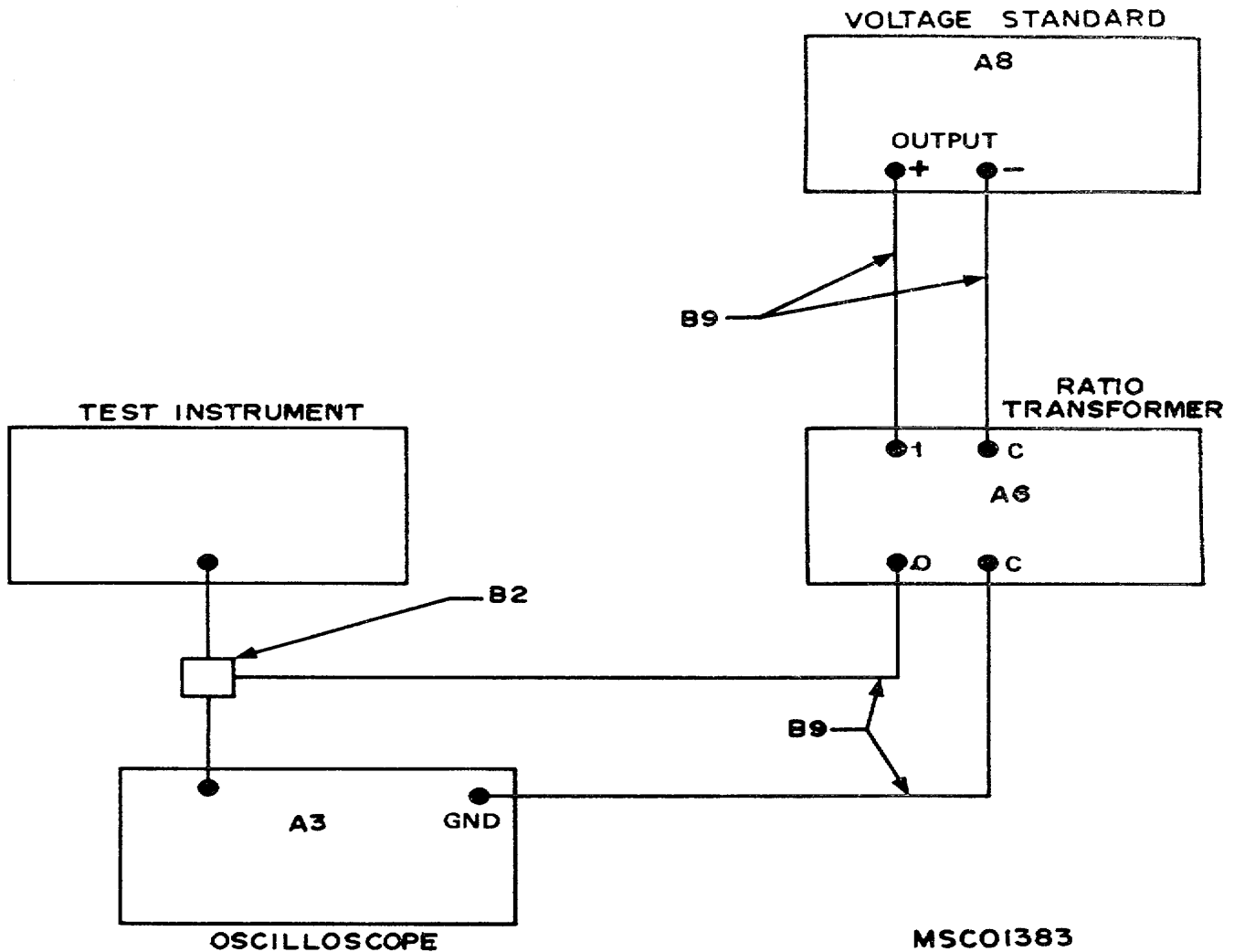

Figure 3. Vertical gain - equipment setup.

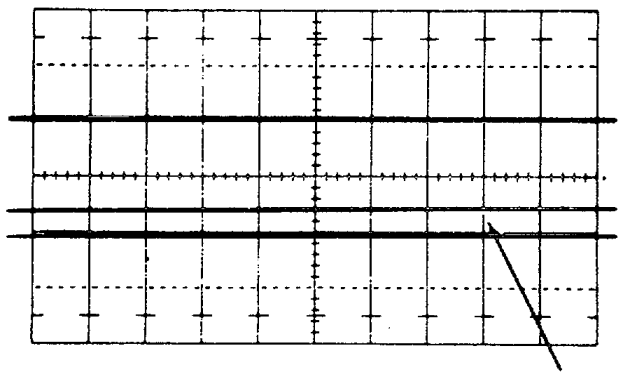
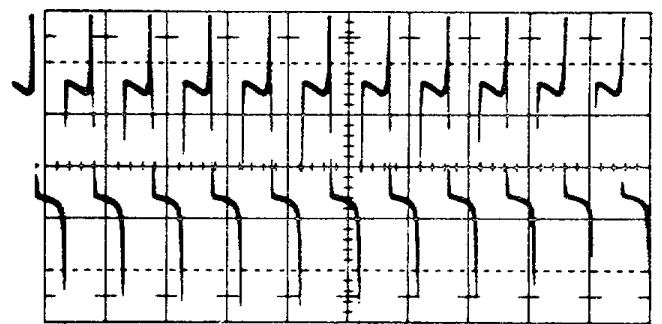

Figure 4. Alternate waveform display.

(3) Adjust TI VERTICAL POSITION control for oscilloscope display of centered waveform. Oscilloscope.



MSC01385
Figure 5. Chopped waveform - unblanked.

crt will display a positive pulse with amplitude of 2.8 centimeters or less.

(4) Set TI Test FUNCTION switch to -PULSE

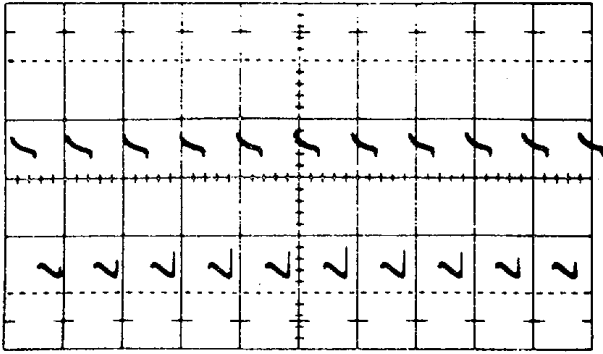

MSCO1386

Figure 6. Chopped waveform—blanked.

Oscilloscope crt will display a negative pulse with amplitude of 5.6 centimeters or greater.

(5) Turn TI AMPLITUDE control fully clockwise. Oscilloscope will display a negative pulse with amplitude of 5.6 centimeters or greater.

(6) Set TI FUNCTION switch to +PULSE. Oscilloscope crt will display a positive pulse with amplitude of 5.6 centimeters or greater.

b. Adjustments

(1) Adjust TI AMPLITUDE control for 4 centimeters of positive pulse display on oscilloscope crt.

(2) Connect test oscilloscope (A7) alternately to TI TEST FUNCTION switch test points A and B (fig. 7), using XI0 probe supplied with test oscilloscope.

(3) Adjust DRIVE BAL R40 (fig. 21 for equal pulse amplitude on test oscilloscope at test points A and B.

(4) Disconnect test oscilloscope.

(5) Connect dc voltmeter (A2) between oscilloscope (A3) J11 pin 10 (inside cover) and chassis ground. Using test lead (BS). Record dc voltmeter indication.

(6) Calculate upper and lower limits as follows: 66% vdc recorded in (5) above = lower limits. 69% vdc recorded in (5) above = upper limits.

(7) Connect dc voltmeter between junction of TI R41 and R54 (fig. 2). using test lead (BS).

(8) Adjust TI PULSE DC LEVEL R30 (fig. 2) for dc voltmeter indication between upper and lower limits calculated in (6) above.

(9) Due to interaction of adjustments, repeat (2) through (8) above until no further adjustments are required.

24. Pulse Repetition Rate (S/N 3994 and below)

a. Performance Check

(1) Adjust oscilloscope (A3) controls for stable display on crt.

(2) Adjust TI AMPLITUDE control for 4 centimeters of positive pulse display on oscilloscope crt.

(3) Set TI REPETITION RATE switch and oscilloscope TIME/CM switch to settings listed in table 5. Oscilloscope will display waveform within limits specified in table 5.

Table 5. Repetition Rate Switch (S/N 3994 and Below)

Test Instrument REPETITION RATE Switch Settings.	Oscilloscope (A3)	
	ME/CM Switch Setting	Display Waveforms Within 10 cm.
LOW	.2 mSEC	7.5 to 12.5 ¹
MED	10μSEC	9 to 15 ²
HIGH	2μSEC	9 to 15

¹Display be from 8 to 12 cycles for types with S/N 1409 and below.

²Display will be from 8 to 12 cycles with S/N 1410 to 3994.

(4) Adjust TI VERTICAL POSITION control to display top of waveform on center vertical graticule line on oscilloscope crt.

(5) Set TI TEST FUNCTION switch to -PULSE. Oscilloscope will display bottom of waveform within 11 centimeter of center graticule line.

b. Adjustments. No adjustments can be made.

25. Pulse Repetition Rate (S/N 3995 and above)

a. Performance Check

(1) Adjust oscilloscope (A3) controls for stable display on crt.

(2) Adjust TI AMPLITUDE control for a 4-centimeter positive pulse display on oscilloscope crt. (3) Set TI REPETITION RATE switch and oscilloscope TIME/CM switch to settings listed in table 6. Oscilloscope will display waveforms within limits specified in table 6.

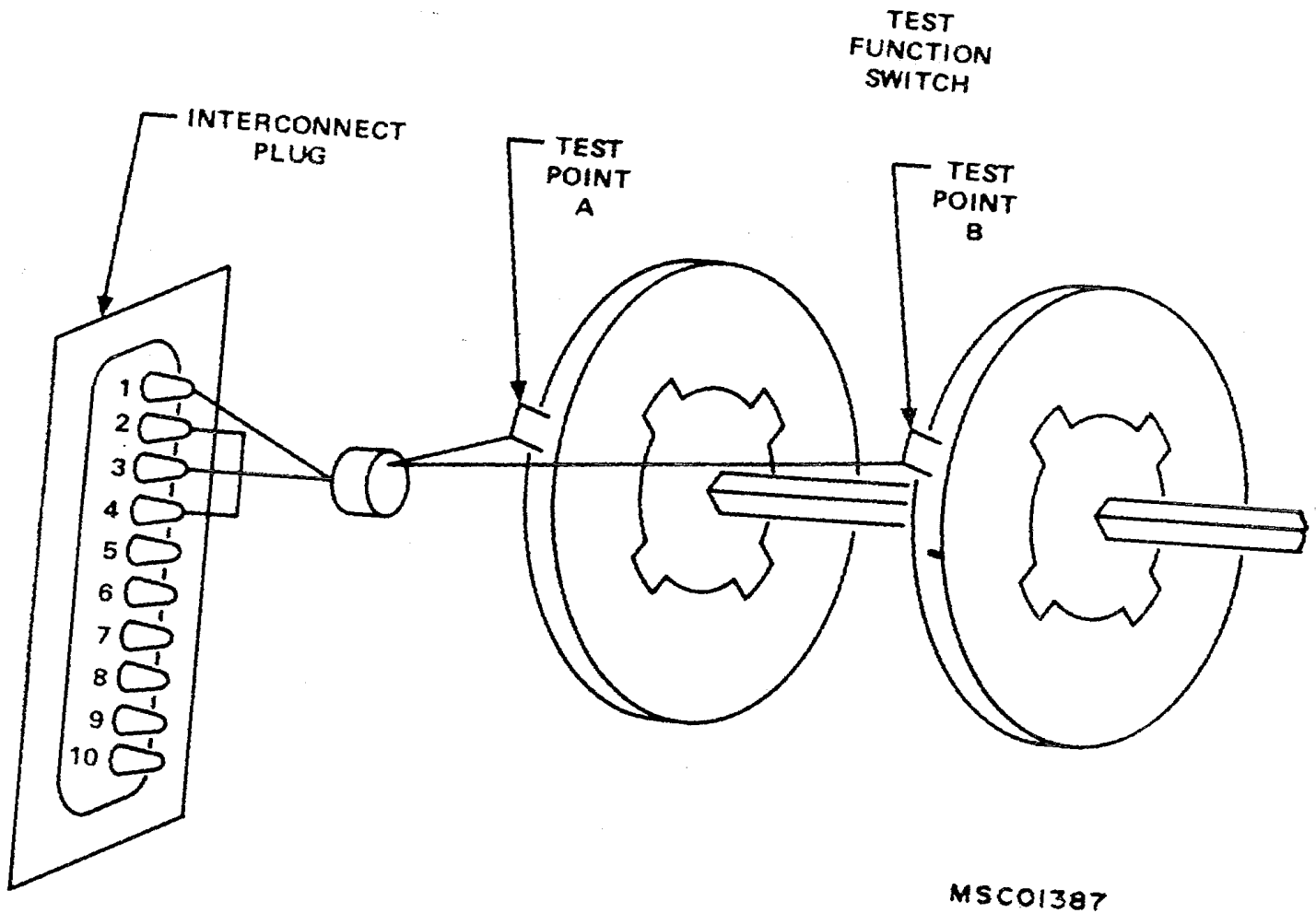

Figure 7. Test function switch

Table 6. Repetition Rate (S/N 3995 and Above)

Test Instrument REPETITION RATE Switch Settings.	Oscilloscope (A3)	
	ME/CM Switch Setting	Display Waveforms Within 10 cm.
1 kHz	1 mSEC	7.5 to 12.5
4 kHz	.2mSEC	6 to 10
15 kHz	50μSEC	5.6 to 9.4
80 kHz	10μSEC	6 to 10
500 kHz	2μSEC	7.5 to 12.5

(4) Adjust TI VERTICAL POSITION control to display top of waveform on oscilloscope crt graticule.

(5) Set TI TEST FUNCTION switch to—PULSE. Oscilloscope crt will display waveform within 1 centimeter of center graticule line.

b. Adjustments. No adjustments can be made.

26. Final Procedure

a. Deenergize and disconnect all equipment.

b. In accordance with TM 38-750, annotate and affix DA Label 80 (US Army Calibration System). When the TI cannot be adjusted within tolerance, annotate and affix DA Form 2417 (Unserviceable or Limited Use) tag.

By Order of the Secretary of the Army:

Official:

PAUL T. SMITH
Major General, United States Army
The Adjutant General

FRED C. WEYAND
General, United States Army
Chief of Staff

Distribution:

To be distributed in accordance with DA Form 12-34A (qty rqr block No. 75), requirements for calibration procedures publications.

RECOMMENDED CHANGES TO EQUIPMENT TECHNICAL PUBLICATIONS



THEN... JOT DOWN THE DOPE ABOUT IT ON THIS FORM, CAREFULLY TEAR IT OUT, FOLD IT AND DROP IT IN THE MAIL!

SOMETHING WRONG WITH THIS PUBLICATION?

FROM: (PRINT YOUR UNIT'S COMPLETE ADDRESS)

DATE SENT

PUBLICATION NUMBER

PUBLICATION DATE

PUBLICATION TITLE

BE EXACT... PIN-POINT WHERE IT IS

PAGE NO.

PARA-GRAPH

FIGURE NO.

TABLE NO.

IN THIS SPACE TELL WHAT IS WRONG AND WHAT SHOULD BE DONE ABOUT IT:

TEAR ALONG PERFORATED LINE

PRINTED NAME, GRADE OR TITLE, AND TELEPHONE NUMBER

SIGN HERE:

DA FORM 2028-2
1 JUL 79

PREVIOUS EDITIONS ARE OBSOLETE.

P.S.—IF YOUR OUTFIT WANTS TO KNOW ABOUT YOUR RECOMMENDATION MAKE A CARBON COPY OF THIS AND GIVE IT TO YOUR HEADQUARTERS.

PIN: 009074-000