

INSTRUCTION MANUAL

Serial Number _____

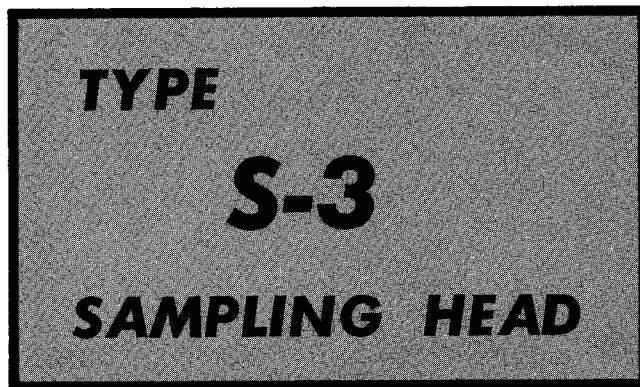

Tektronix, Inc.

S.W. Millikan Way ● P. O. Box 500 ● Beaverton, Oregon 97005 ● Phone 644-0161 ● Cables: Tektronix

070-0765-00

868



WARRANTY

All Tektronix instruments are warranted against defective materials and workmanship for one year. Tektronix transformers, manufactured in our plant, are warranted for the life of the instrument.

Any questions with respect to the warranty mentioned above should be taken up with your Tektronix Field Engineer.

Tektronix repair and replacement-part service is geared directly to the field, therefore all requests for repairs and replacement parts should be directed to the Tektronix Field Office or representative in your area. This procedure will assure you the fastest possible service. Please include the instrument Type and Serial or Model Number with all requests for parts or service.

Specifications and price change privileges reserved.

Copyright © 1968 by Tektronix, Inc., Beaverton, Oregon. Printed in the United States of America. All rights reserved. Contents of this publication may not be reproduced in any form without permission of the copyright owner.

CONTENTS

- Section 1 Specification
- Section 2 Operating Instructions
- Section 3 Circuit Description
- Section 4 Maintenance
- Section 5 Performance Check/Calibration
- Section 6 Abbreviations and Symbols
- Section 7 Parts Ordering Information
- Section 8 Electrical Parts List
- Mechanical Parts List Information
- Mechanical Parts List
- Diagrams
- Mechanical Parts List Illustrations
- Accessories

Abbreviations and symbols used in this manual are based on or taken directly from IEEE Standard 260 "Standard Symbols for Units", MIL-STD-12B and other standards of the electronics industry. Change information, if any, is located at the rear of this manual.

SEE PARTS LIST FOR SEMICONDUCTOR TYPES

SERIES N MODEL 1, 2, 3



Fig. 1-1. Type S-3 Sampling Head and Probe.

SECTION 1

TYPE S-3 SPECIFICATION

Change information, if any, affecting this section will be found at the rear of the manual.

General Information

The Type S-3 Sampling Head is used with Tektronix 3S-series units such as the Type 3S2, 3S5, and 3S6. The Type S-3 consists of a plug-in head with a permanently attached, miniature 1X probe containing the sampling bridge. See Fig. 1-1.

The Type S-3 can be installed directly into sampling units such as the Type 3S2 or Type 3S5. It can also be used remotely with the Type 3S2 or Type 3S5, on an optional 3 foot or 6 foot extender cable. When used with a Type 3S6 Sampling Unit, the Type S-3 is plugged into the dual-input interconnecting cable provided with the sampling unit.

Input characteristics of the sampling systems are determined by the Type S-3. The probe tip has a low-frequency input resistance of 100 k Ω paralleled by about 2.3 pF of capacitance. Input resistance and capacitance with plug-in accessories (coupling capacitor, 10X or 100X attenuators) attached to the probe tip can be found later in this section as well as in the Operating Instructions. Other input characteristics, both with and without the plug-on accessories, are also given in this section.

An offset voltage of either ± 1 volt or ± 2 volts may be selected with a toggle switch (OFFSET) located on the sampling head front panel. The X1 position of the OFFSET switch provides an offset voltage range of ± 1 V while the X2 position provides a range of ± 2 V to the probe sampling bridge. The Type S-3 does not provide a trigger pickoff from the input signal for internal triggering of the associated sampling unit. Vertical deflection factor of the sampling system is labeled at the top of the Type S-3 as mVOLTS/DIV; the label refers to the sampling unit Units/Div switch of the corresponding channel.

Digital Unit Programming Connections

The Type S-3 has two contacts at its rear connector that program the decimal and units-of-measure lamps of the Type 6R1A or Type 230 Digital Unit. These connections are not needed when using a Type 3S2 Sampling Unit. When using a Type 3S5 or Type 3S6 Sampling Unit, one contact notifies the digital readout unit, through the sampling unit digital control circuits, that the Type S-3 is a voltage-measuring head. This causes the Volts lamp to light. The other sampling head contact notifies the digital readout unit, through the sampling unit digital control circuits, that the Type S-3 sensitivity requires no decimal shift of the numbers around the sampling unit Units/Div switch.

ELECTRICAL CHARACTERISTICS

Characteristics

The following characteristics apply over an ambient temperature range of 0° C to +50° C and after a five minute warmup, providing the instrument was calibrated at a temperature between +20° C and +30° C.

Characteristics listed below apply only after the Type S-3 has been properly mated to the sampling unit and indicator oscilloscope, and after these units have been given sufficient warmup time. To determine the particular system warmup requirements, refer to the related amplifier and indicator oscilloscope instruction manual. A procedure for mating the Type S-3 to the sampling unit can be found in the Operating Instructions.

ELECTRICAL CHARACTERISTICS

Characteristic	Performance Requirement		
DC Input Resistance			
Probe Only	100 k Ω within 1/4%		
With 10X Attenuator	1 M Ω within 1%		
With 100X Attenuator	1 M Ω within 1%		
Input Capacitance			
Probe Only	≈ 2.3 pF		
With 10X Attenuator	≈ 2 pF		
With 100X Attenuator	≈ 1.7 pF		
With Coupling Capacitor	≈ 4.5 pF		
Coupling Time Constant (probe and coupling capacitor only)	≥ 100 μ s		
Deflection Factors	mV/Div, (1 times the numbers around the sampling unit Units/Div switch).		
Accuracy ¹			
Probe Only	Within 1.0%		
With 10X Attenuator	Within 2.25%		
With 100X Attenuator	Within 3.0%		
Signal Offset Range	With probe only	Into 10X attenuator	Into 100X attenuator
OFFSET switch at X1	± 1 V	± 10 V	± 100 V
OFFSET switch at X2	± 2 V	± 20 V	± 200 V
Offset Accuracy ¹	Probe only	With probe and 10X attenuator	With probe and 100X attenuator
OFFSET switch at X1	$\pm 1.6\%$	$\pm 3.1\%$	$\pm 3.85\%$
OFFSET switch at X2	$\pm 1.35\%$	$\pm 2.85\%$	$\pm 3.6\%$

¹Add these tolerances to sampling unit accuracy to determine system accuracy.

Specification—Type S-3

Characteristic	Performance Requirement
Response to Step Signals Risetime (10% to 90%) Probe Only	350 ps or less
With 10× Attenuator	400 ps or less
With 100× Attenuator	500 ps or less
Pulse Flatness Deviation Probe Only	+8%, -2% or less, total of 10% or less P-P within 2 ns after step reaches 100%; +1%, -1% or less, total of 2% or less P-P thereafter.
With 10× Attenuator	+2%, -5% or less, total of 7% or less P-P within 5 ns after step reaches 100%; +1%, -1% or less, total of 2% or less P-P thereafter.
With 100× Attenuator	+5%, -8% or less, total of 13% or less P-P within 5 ns after step reaches 100%; +2%, -5% or less, total of 7% or less P-P from 5 ns to 30 ns after step; +1%, -1% or less, total of 2% or less P-P thereafter.
Maximum Operating Signal Voltage Probe Only	2 V P-P
With 10× Attenuator	20 V P-P
With 100× Attenuator	200 V P-P
Safe Overload Signal Voltage Probe Only	Do not exceed + or - 100 V (peak) limits. Maximum sine wave input is 20 V P-P.
With 10× Attenuator	Do not exceed + or - 350 V (peak) limits. Maximum sine wave input is 200 V P-P.
With 100× Attenuator	Do not exceed + or - 350 V (peak) limits. Maximum sine wave input is 200 V P-P.
Loop Gain Probe Only	Adjustable to unity on the sampling unit front panel for signals up to 1 V P-P; when the loop gain is adjusted to unity with

Characteristic	Performance Requirement
	positive input signals, the loop gain will be within 5% of unity with negative input signals and vice versa.
With 10× Attenuator	Adjustable on the sampling unit front panel to unity for signals up to 10 V P-P; when the loop gain is adjusted to unity with positive input signals, the loop gain will be within 5% of unity with negative input signals and vice versa.
With 100× Attenuator	Adjustable on the sampling unit front panel to unity for signals up to 100 V P-P; when the loop gain is adjusted to unity with positive input signals, the loop gain will be within 5% of unity with negative input signals and vice versa.
Displayed Noise (no accessories connected to probe tip)	3 mV or less, measured tangentially.

ENVIRONMENTAL CHARACTERISTICS

Storage	Operating
Temperature— -40°C to +65°C.	Temperature — As stated preceding Electrical Characteristics table.
Altitude—To 50,000 feet.	Altitude—To 15,000 feet.

MECHANICAL CHARACTERISTICS

Dimensions— Height \approx 2 inches (head)	Width \approx 1 $\frac{3}{4}$ inches
	Length \approx 4 $\frac{1}{2}$ inches
Probe cable length \approx 3 feet 6 inches	
Construction— Epoxy laminated circuit boards. Aluminum wrap-around cabinet with aluminum casting at front and rear. Anodized aluminum front panel.	
Accessories— An illustrated list of the accessories supplied with the Type S-3 is at the end of the Mechanical Parts List pullout pages.	

SECTION 2

OPERATING INSTRUCTIONS

Change information, if any, affecting this section will be found at the rear of the manual.

General Information

This section provides the basic information required for operation of the Type S-3 Sampling Head, including installation and First Time Operation.

The Type S-3 is used with some Tektronix sampling units such as Types 3S2, 3S5 and 3S6 using one or two S-series sampling heads. One of these sampling units and a sweep unit plugged into an indicator oscilloscope completes the sampling system. The choice of real or equivalent time sampling is a function of the sweep unit used.

The Type S-3 consists of a plug-in head with a permanently attached miniature $1\times$ probe containing the sampling bridge circuit. Accessories supplied include a coupling capacitor, a $10\times$ and a $100\times$ attenuator which provide for operation over a wide range of input signal voltages.

An Offset switch on the sampling head panel allows selection of an Offset voltage range of either $+1$ Volt to -1 Volt or $+2$ Volts to -2 Volts as set by either $\times 1$ or $\times 2$ switch position. The DC Offset control of the sampling unit sets the DC Offset voltage within the above ranges. This voltage effectively offsets an equal amount of the input signal at the tip of the probe without attenuators, and 10 or 100 times with $10\times$ or $100\times$ attenuators.

Installing the Type S-3 Sampling Head

Fig. 2-1 shows the Type S-3 partially installed into a Type 3S2 Sampling Unit with Type 561A Oscilloscope and Type 3T2 Random Sampling Sweep. The sampling head (or heads) can be plugged into the sampling unit as shown, or used remotely on a special extender cable. Three and six foot extender cables are available. Order the three foot extender cable by Tektronix Part No. 012-0124-00, or the six foot extender cable by Tektronix Part No. 012-0125-00. Contact your local Tektronix Field Engineer or Representative for price and availability of these optional accessories.

To insert the Type S-3 into the right or left hand compartments of the sampling unit, proceed as follows:

1. Pull the latch knob (Fig. 2-1) outward from the front panel (the latch knob will push out normally when the unit is inserted if the knob is left free to move).
2. Insert the Type S-3 slowly into the compartment, so the two plastic guides in the compartment engage the S-3.
3. Push the Type S-3 completely into the compartment.
4. Push the latch knob to lock the S-3 in place.

To remove the Type S-3 from the compartment, pull the latch knob away from the front panel, then pull the unit from the compartment.

To use the Type S-3 on an extender cable, install as follows:

1. Pull the latch knob located on the head end of the extender outward from the panel (the latch knob will push out normally when the extender is inserted if the knob is free to move).
2. Insert the extender cable head end slowly into the desired compartment in the sampling unit so the two plastic guides in the compartment engage the unit.
3. Push the head completely into the compartment.
4. Push the latch knob to lock the extender cable head end in place.
5. Connect the Type S-3 to the other end of the extender cable in a similar manner, and set the latch knob to hold it in place.
6. To remove the Type S-3 from the extender cable, pull the latch knob on the front panel of the Type S-3, and remove the unit from the extender cable.

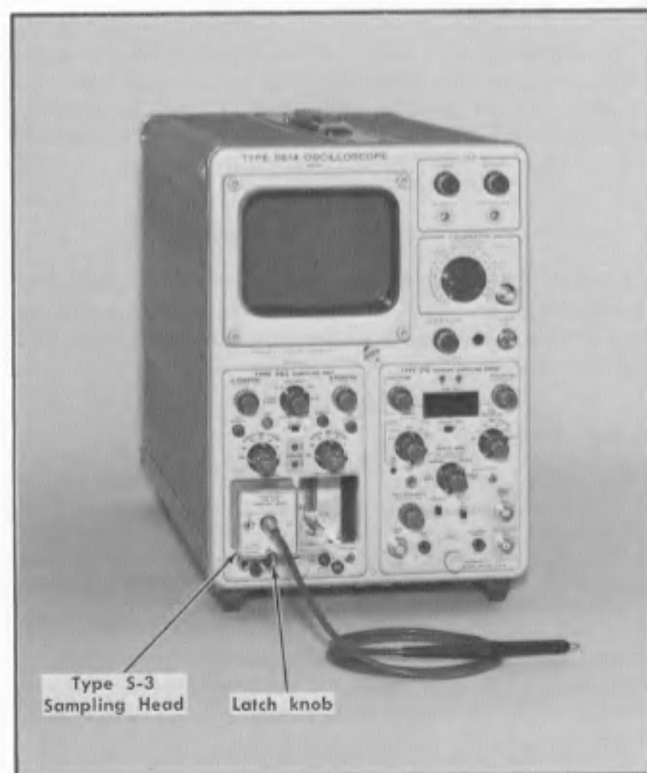

Fig. 2-1. Installation Information.

Operating Instructions—Type S-3

7. To remove the extender cable head from the sampling unit compartment, pull the latch knob outward from the front of the panel, then pull the unit free.

Mating

The vertical deflection factor labeled as mVOLTS/DIV by the Type S-3, and the sampling system loop balance (adjusted by the Bridge Bal control) must be considered when mating a Type S-3 with a sampling unit. If the sampling unit is a Type 3S2, the system loop gain (as adjusted by the sampling unit Memory feedback capacitor) must be checked. A check of the loop gain linearity at 1-V peak to peak input to the probe tip will determine if the sampling unit loop gain is correctly adjusted. See the Type 3S2 Sampling Unit instruction manual Calibration Procedure for proper adjustment of the system loop gain.

The mVOLTS/DIV label on the Type S-3 names the deflection factor units of the sampling unit Units/Div switch located directly above the label. For example, with the Type S-3 installed in a Type 3S2 and the Units/Div switch set at 100, each major division of CRT deflection corresponds to 100 millivolts of input signal (when the Variable control is in the Cal position). Additionally, the deflection factor is changed by adding an accessory attenuator of either 10X or 100X attenuation to the S-3 probe input.

The deflection factor is mated to the indicator oscilloscope CRT by adjusting the sampling unit Gain control. Refer to the sampling unit manual for its Gain adjustment. Power supplies and circuit interconnections are made through the two connectors at the rear of the Type S-3.

Bridge Balance

The Bridge Balance control of the Type S-3 should be adjusted whenever the sampling head is changed from one sampling unit to another, or is operated on an extender cable. Location of the control and details of its adjustment are described in First Time Operation which follows.

FIRST TIME OPERATION

The First Time Operating procedure utilizes, in addition to the Type S-3, a Type 3S2, Type 3T2, Type 561A, and Type 284. The Type 284 is used as a signal source with Type VP-2 and 50 Ω end-line termination. See Fig. 2-2.

Setup Information

Make sure that the Horiz Plug-in Compatibility switch on the Type 3S2 bulkhead immediately behind the front panel is in the Sampling 3T-series position. Also make sure the Samples/Div switch SW450 on the Type 3T2 bulkhead behind the front panel is set to the Variable (Front Panel) position.

1. With the Type 561A Power switch off, insert a Tektronix Type 3S2 Sampling Unit into the vertical compartment (left) and a Tektronix Type 3T2 Random Sampling Sweep into the horizontal plug-in compartment (right).

2. Insert the Type S-3 Sampling Head into Channel A compartment (left) of the Type 3S2 leaving the latch knob free to move. Once the S-3 is seated, push the latch to lock it in place.

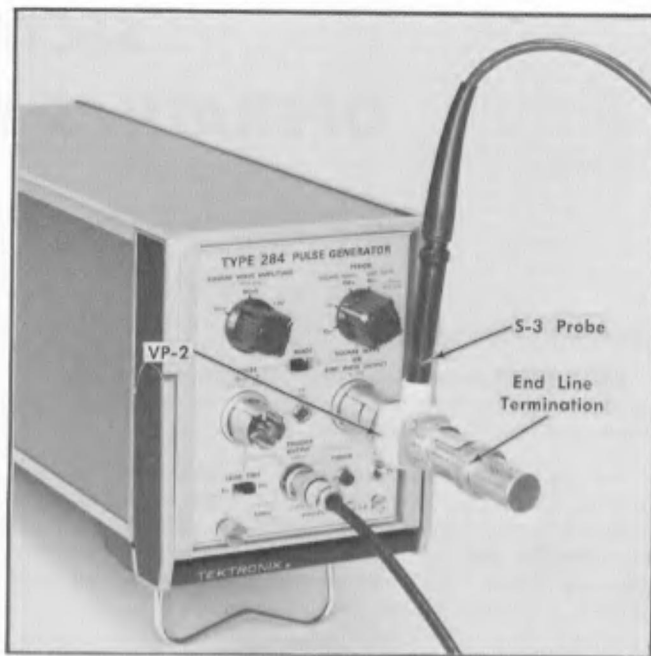

Fig. 2-2. S-3 probe - VP-2 connections.

3. Set the Intensity control on the Type 561A fully counter-clockwise.

4. Connect the Type 561A to a power source which meets its voltage and frequency requirements.

5. Set the Power switch to on. Allow about 5 minutes warm-up so the units reach operating temperature before proceeding. (The Type S-3 can be installed or removed while the power is on.)

6. For single-trace operation, set the controls as follows:

Type S-3

OFFSET $\times 1$

Type 3S2

Display Mode	CH A
Normal-Smooth	Normal
A and B Position	Midrange
DC Offset (both Channels)	Midrange (5 turns from one end)
Units/div (both Channels)	200
Variable (both Channels)	Cal
Invert (both Channels)	Push in
Dot Response (both Channels)	Midrange
B Delay	Midrange

Type 3T2

Horiz Position	Midrange
Samples/Div	9 o'clock position

Display Mode	Normal
Start Point	With Trigger
Range	10 μ s
Display Mag	$\times 1$
Time Magnifier	$\times 2$
Variable	Cal
Time Position	Both fully clockwise
Trig Sensitivity	Fully Clockwise
Recovery Time	Optional
Trigger Polarity	+
Trigger Source	Ext

Type 284

Square Wave Amplitude	1.0 V ¹
Period	1 μ s
Mode	Square Wave Output
Lead Time	Optional

7. Place the probe tip into the Type VP-2 as shown in Fig. 2-2. (Remove the insulating sleeve from the probe tip to fit it into an early model Type VP-2.) Terminate the VP-2 with GR874-W50B 50 Ω end-line termination (Tektronix Part No. 017-0081-00). Connect the Trigger output signal from the Type 284 through a 5 ns coaxial cable with BNC connectors to the External Input 50 Ω connector of the Type 3T2.

8. Advance the Type 561A Intensity control until the free running trace brilliance is at the desired viewing level.

9. Center the trace on the graticule with the Type 3S2 A Position control and/or the DC Offset control. Adjust the Type 3T2 Trig Sensitivity control for a stable triggered display of a five-cycle square wave with an amplitude of about 5 divisions.

Probe Compensation

The 1 μ s square wave signal is the correct frequency to use to compensate the probe.

10. If the display (step 9) top and bottom portions are flat as shown in Fig. 2-3C, the probe is properly compensated and no adjustment is required. The 10 \times and 100 \times attenuators must be compensated after the probe is compensated. (The adjustment information is given in the attenuator compensation paragraph later in this section.)

11. The probe will require compensation only if the display shows over- or under-compensation as in Fig. 2-3A or B.

12. To adjust the probe compensation, loosen the probe body and tip (shown in Fig. 2-4) by turning the locking nut counterclockwise.

13. Slowly turn the probe body and tip assembly until the 1 μ s square wave top and bottom are flat as shown in Fig. 2-3C. Then turn the locking nut counterclockwise to tighten the probe and tip assembly in place. Readjust if necessary to assure a flat display after the locking nut is tight.

¹VP-2 with 50 Ω end-line termination.

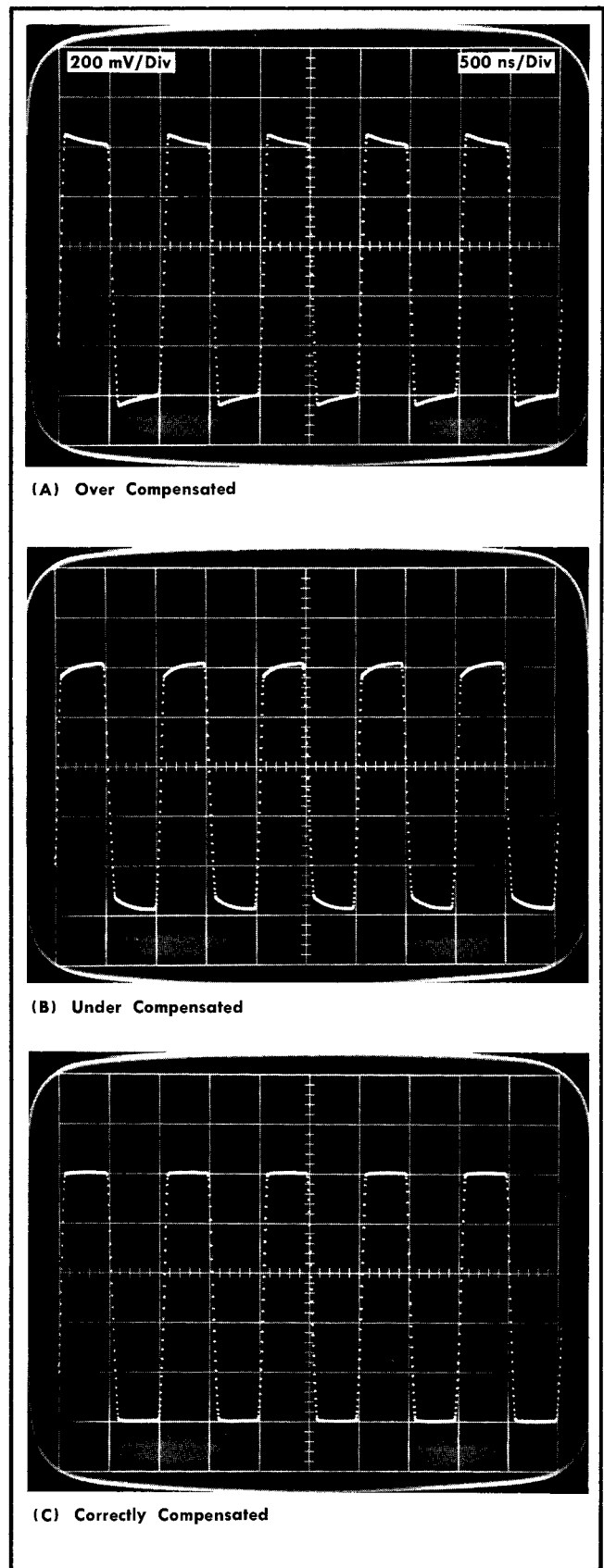

(A) Over Compensated

(B) Under Compensated

(C) Correctly Compensated

Fig. 2-3. Probe compensation displays.

Adjusting Dot Response (Loop Gain) Control

Sequential Sampling. One method of adjusting the Dot Response control for unity loop gain is to use a double or multiple-triggered sweep. This causes each sample to respond to the full signal amplitude and produce a display similar to Fig. 2-5A or B.

14. To obtain a display similar to that of Fig. 2-5A or B, change the Time Magnifier to $\times 5$ (200 ns/Div) and turn the Trig Sensitivity control into the free-run region. Then adjust the Recovery Time control until the desired display appears.

15. Turn the Channel A Dot Response control to obtain a display showing unity loop gain (see Fig. 2-5B). Either the upper or the lower portion of the display may be adjusted to level. In Fig. 2-5B the upper portion of the double triggered display is adjusted showing the lower portion at near level within 5% of the full signal amplitude. Fig. 2-5A shows less than unity loop gain. This requires clockwise rotation of the Dot Response control to obtain unity loop gain.

The double triggering shown in Fig. 2-5A and B is not useful when making amplitude measurements.

16. After the Dot Response control is adjusted for unity loop gain, turn the Trig Sensitivity control counterclockwise into the triggered region for a stable trace of a properly triggered display similar to Fig. 2-5C.

Random Sampling. Another convenient method of adjusting the Dot Response control for unity loop gain uses random process sampling.

17. Change the following controls:

Type 3T2

Start Point	Before Trigger
Time Magnifier	$\times 50$

Type 284

Period	10 ns
--------	-------

18. Loop gain greater than unity will produce a display similar to Fig. 2-6A. Variations from the display shown can be caused by different settings of the Recovery Time, Samples/Div and Trigger Sensitivity controls on the Type 3T2.

Loop gain deviations from unity are best observed when the Type 3T2 Time Magnifier is set at $\times 20$ or $\times 50$. Adjust the Type 3S2 Dot Response control for unity loop gain as shown in Fig. 2-6B.

Bridge Balance Adjustment

Connect a bench multimeter set for ≈ 30 V full scale between ground and the Type 3S2 Channel A Offset jack. Adjust the Type 3S2 DC Offset control until the multimeter reads 0 Volts. Increase the meter sensitivity and repeat the adjustment for greater accuracy.

19. Disconnect the Type VP-2 from the Type 284, leaving the Type S-3 probe in the Type VP-2 terminated by the end-line termination. This avoids pickup from the probe tip. Turn the Type 3T2 Trig Sensitivity control clockwise to free run the sweep.

20. Switch the Type 3S2 Units/Div control from 200 to 20, adjusting the Type S-3 Bridge Bal control for the minimum trace shift. See Fig. 2-7 for the location of the Bridge Bal control. This adjustment must be made whenever the Type S-3 is shifted from one sampling unit to another, or operated on a sampling head extender cable.

NOTE

Physical movement of the Type S-3 probe cable will shift the trace vertically a few millivolts after the Bridge Bal control is adjusted. For correct low level DC voltage measurements, carefully adjust the Bridge Bal control with the probe in the same physical location as it will be used (or connected to the test point where it will be used before the signal is present).

Attenuator Compensation

The $10\times$ and the $100\times$ attenuator probe attachments can be compensated only after the probe has been compensated. See steps 10 to 13. A fast-rise square wave signal with an amplitude of about 1 V (for $10\times$ attenuator) and about 10 V (for $100\times$ attenuator) at a frequency of about 50 kHz is required to properly compensate the attenuators. A Tektronix Type 106 Square Wave generator is used in the following procedure.

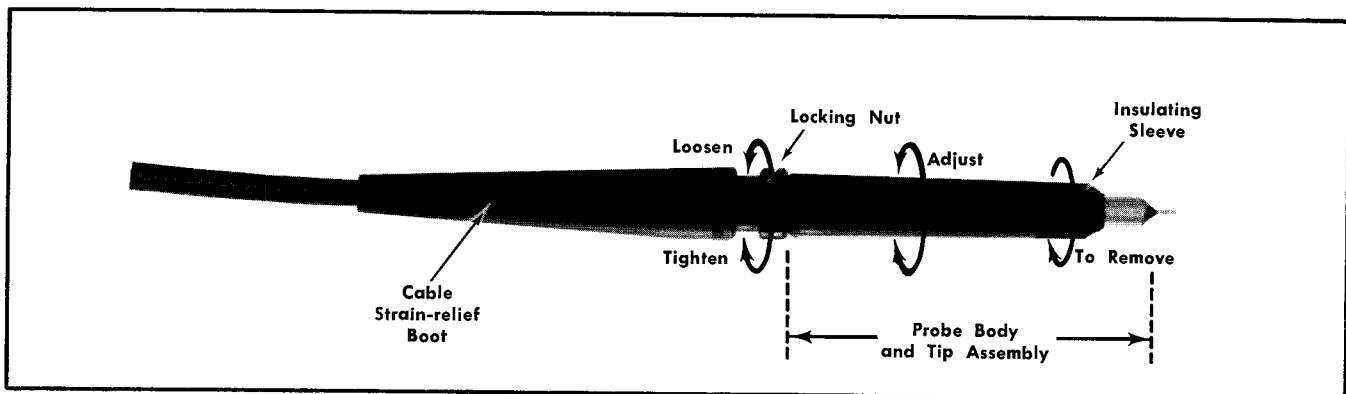

Fig. 2-4. Probe composition procedure.

21. Connect the Type 106 Hi Amplitude Output to the VP-2 voltage pickoff with the $50\ \Omega$ termination installed. Remove the insulating sleeve on the $10\times$ attenuator, attach the attenuator (by the threaded connection) to the Type S-3 probe, and place the attenuator tip in the VP-2. Connect the Type 106 Trigger Output through a coaxial cable to the Type 3T2 Ext Trig Input $50\ \Omega$ connector. Set the Type 106 Square Wave Repetition Rate to 50 kHz.

22. Change the following controls:

Type 3T2

Range	100 μ s	} Sweep Rate
Time Magnifier	$\times 5$	

Type 3S2

Units/Div	100
-----------	-----

23. Adjust the Type 106 Amplitude control for a 5-division display.



(A) Double-triggered, $<$ unity loop gain



(B) Double-triggered, unity loop gain

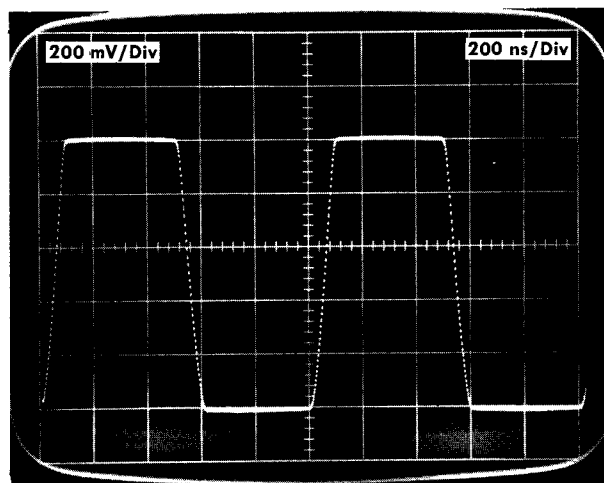

(C) Properly triggered

Fig. 2-5. Typical display of unity loop gain adjustment in normal sequential sampling.

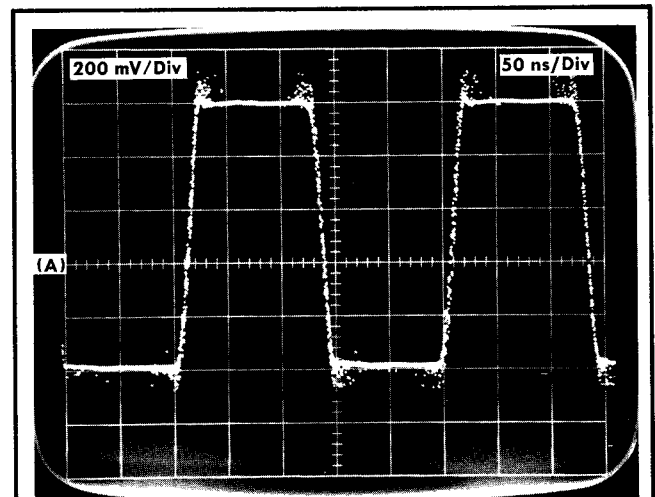

(A)

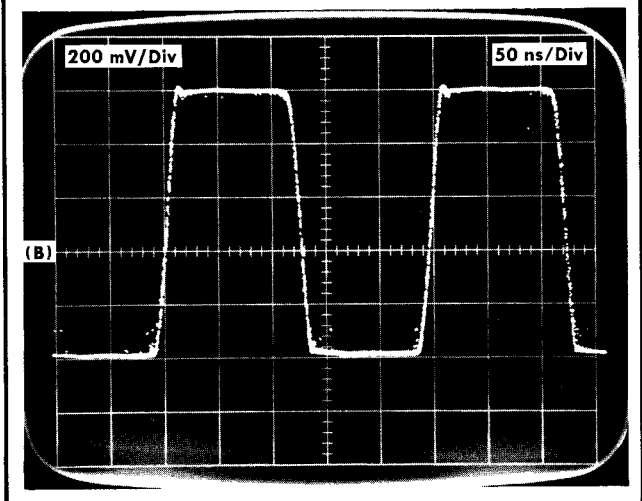

(B)

Fig. 2-6. Typical display for unity loop gain adjustment in random sampling operation.

TABLE 2-1
Type S-3 Input System

System	Source Loading	Time Constant	Maximum Input Signal	Safe Overload
Probe Only	100 k Ω , \approx 2.3 pF	DC Coupling	2 V P-P	\pm 100 V DC or 20 V P-P Sine wave
Probe & AC Coupling Capacitor	100 k Ω , \approx 4.5 pF	100 μ s	2 V P-P	Note 2
Probe & 10 \times Attenuator	1 M Ω , \approx 2.0 pF	DC Coupling	20 V P-P	\pm 350 V DC or 200 V P-P Sine wave
Probe & 10 \times Attenuator & AC Coupling Capacitor	1 M Ω , \approx 4.0 pF	1000 μ s	20 V P-P	Note 2
Probe & 100 \times Attenuator	1 M Ω , \approx 1.7 pF	DC Coupling	200 V P-P	\pm 350 V DC or 200 V P-P Sine wave
Probe & 100 \times Attenuator & AC Coupling Capacitor	1 M Ω , \approx 3.8 pF	1000 μ s	200 V P-P	Note 2

²Maximum input voltage with AC Coupling Capacitor is 200 V combined DC and AC peak.

24. Adjust the Type 3T2 Trig Sensitivity control for a stable triggered display. Use the Time Position control to center the top of the square wave. If the top of the square wave is level, the attenuator is properly compensated and no adjustment is required.

25. If the square wave top display is not level, compensate the 10 \times attenuator by carefully adjusting the capacitor in the attenuator with a small screwdriver.

26. Remove the 10 \times attenuator and install the 100 \times attenuator. Set the Type 106 Amplitude control fully clockwise (maximum amplitude). Set the Type 3S2 Units/Div switch to 50 and the Variable control for a 5 division display. If the top of the square wave is level, the attenuator is properly compensated and no adjustment is required.

27. If the square wave top display is not level, compensate the 100 \times attenuator by carefully adjusting the capacitor in the attenuator with a small screwdriver.

Coupling Capacitor

The coupling capacitor attachment for the Type S-3 is a 1000 pF (200 volt) capacitor. The capacitor can be used at the Type S-3 probe tip with or without an attenuator to AC couple the input signal. The capacitor adds some additional shunt capacitance at the probe tip. The input capacitance and the time constant with the coupling capacitor attached are shown in Table 2-1.

DC OFFSET Range Switch

The DC Offset switch allows selection of an offset voltage range of either +1 Volt to -1 Volt or +2 Volts to

-2 Volts as set by either the \times 1 or \times 2 switch position. The sampling unit DC Offset control selects the offset voltage within the above ranges. The offset voltage can be used to cancel the effect of a DC input voltage of up to \pm 2 volts at the S-3 probe (without attenuators), up to \pm 200 volts using the 100 \times attenuator. For further DC offset voltage information, see the Operating Instruction section of the manual for the sampling unit in use.

GENERAL OPERATING INFORMATION

Input Voltage Considerations

Proper displays of various signal amplitudes require special attention to the type of time base generation in use. There are also input voltage limits that must be observed to prevent either display distortion or damage to the Type S-3.

The input voltage limits depend upon whether the probe is used alone or in combination with an accessory attenuator and/or capacitor. Table 2-1 shows the maximum input signal and the safe overload voltage for each system combination.

Where unity loop gain is required, accurate displays are possible to achieve only when the input amplitude and the time base generation mode are both considered. The two time base generation modes are: (1) normal process sampling, where each dot is displayed in sequence across the CRT, and (2) random process sampling where the dots are not necessarily displayed in a sequence that progresses uniformly across the CRT. The Type 3T2 Random Sampling Sweep unit presents random process sampling displays in a controlled sequence very similar to normal process sampling when the Time Magnifier switch is at \times 1 or \times 2 and the trigger signal repetition rate is uniform. The random process dot sequence

is definitely not sequential when the Time Magnifier switch is anywhere between $\times 5$ and $\times 50$, with the dot presentation completely random at $\times 50$. The Type 3T2 can be operated in a normal process mode, and all other Tektronix sampling sweep units generate only a normal process sequential dot display.

Unity loop gain displays are not usually required when the signal rate of rise and the sweep rate selected provide a large number of dots for any vertical display change. Unity loop gain is required for some random process sampling displays, and for normal process displays where there are either no samples, or less than about 6 samples in a step transition. (Many dots in any vertical change permits valid random process displays without unity loop gain when the Type 3T2 Time Magnifier is at $\times 1$ or $\times 2$.)

In summary, unity loop gain exists when the vertical channel (sampling head and sampling unit) will accurately shift a sample dot 100% of the signal amplitude. The Specification Section lists the loop gain linearity limits as $\pm 5\%$ for certain limited signal amplitudes discussed below. A 5% loop gain linearity means that the vertical channel will shift a dot in the positive direction 100% of the full signal amplitude, but minus transitions may shift a dot between -95% and -105% of the full signal amplitude, and vice versa. (The Dot Response control thus allows either the display top or bottom to be adjusted to unity loop gain for close examination of signal detail.) Unity loop gain is obtained by proper adjustment of the sampling unit Dot Response control as described in First Time Operation.

Input signal amplitude limits for unity loop gain within the 5% linearity tolerance are listed in Table 2-2. The input voltage columns are for signal amplitudes of 1.0V peak to peak and 2.0V peak to peak anywhere between +2V and -2V DC.

TABLE 2-2

Input Signal Amplitude Limits Allowing Unity Loop Gain Vs Sampling Unit mVOLTS/DIV Deflection Factor. (Probe without attenuators)

Sampling Unit Units/Div Switch	Input Voltage	
	1.0 V P-P	2.0 V P-P
All positions 200 to 2	yes	no
	Either Normal or Random Process	
Limited to positions of 20 to 2	yes	yes
	Either Normal or Random Process	
All positions 200 to 2	yes	yes
	Normal Process only with > 6 dots in a 100% vertical transition.	

Input Signal Connection Precautions

Accurate displays of signals containing very fast transitions or very high frequencies are possible only when short ground connections are made at the probe tip. The Type S-3 probe shunt resistance and capacitance are shown in Table 2-1 for each combination of probe, attenuator and coupling capacitor. For example, the table shows that the probe only has a loading of 100 k Ω paralleled by ≈ 2.3 pF. The signal source impedance must be low when measuring pulses with fast rise times near the system limit. A ground wire lead adds series inductance to the probe tip ground,

which will decrease the rise time or cause ringing under fast rise conditions. Use the shortest ground lead possible or use special adapters for mating the Type S-3 probe to coaxial systems.

Each time a sample is taken, a small amount of strobe kick-out signal is present at the probe tip. Some fast generator circuits, such as the Type 284 Pulse Output circuit, are sensitive to the strobe kickout signal. When using the Type 284 Pulse Generator Output signal to drive the probe, use a coaxial line of at least 8 cm length between the Type 284 Pulse Output connector and the Type S-3 Probe.

Probe Adapters

Voltage Pick-off Adapter. The Tektronix Voltage Pick-off Adapter VP-2 (Tektronix Part No. 017-0077-01) permits using the Type S-3 probe within a closed 50 ohm system with negligible effect on the signal. A VP-2, terminated in 50 Ω at each end GR874 connector, presents a 62.5 Ω source resistance to the Type S-3 probe tip.

Probe Tip to GR Adapter. (Tektronix Part No. 017-0076-00.) Allows the probe to be connected directly to GR874 coaxial connectors. If the probe and adapter are connected to an unterminated 50 Ω cable, the source resistance to the probe tip is 50 Ω . The signal amplitude from a 50 Ω source is $2\times$ its terminated value, and signal reflections back to the signal source must be considered. Re-reflections from signal sources other than 50 Ω may be included as part of the display. The Probe Tip to GR Adapter should be used at the end of 50 Ω coaxial cables whose signal source impedance is also 50 Ω . Use of a good reverse termination will absorb the reflected signal returned to the source by the probe tip mismatch and prevent display confusion.

Probe Tip to BNC Adapter. (Tektronix Part No. 013-0084-00.) This adapter is identical in function to the Probe Tip to GR Adapter, but is fitted with BNC connectors.

Bayonet Ground Assembly. (Tektronix Part No. 013-0085-00.) The Bayonet ground assembly (a probe accessory supplied with the Type S-3) provides a very short ground connection at the probe tip. The bayonet tip is convenient when the ground plane is adjacent to the signal source.

Chassis Mount Test Jack. (Tektronix Part No. 131-0258-00.) Can be mounted directly into the test circuit so that the Type S-3 probe can be conveniently connected. This allows a good signal ground connection but adds about 2 pF capacitance over the normal probe tip value.

Other accessories including ground leads are shown on the accessories pull-out page at the rear of this manual.

Measuring Risetime

The Type S-3 is useful to show risetime and detect aberrations of signals in circuits that are properly coupled to the Type S-3. The risetime of both the generator (or source), and the Type S-3 must be taken into consideration. The Type S-3 risetime is slowed with the addition of an attenuator. See Section 1 for risetime specifications.

Signals with risetimes as fast as about 0.8 ns (800 picoseconds) can be measured using the Type S-3 without any special considerations. Read the 10% to 90% risetime directly

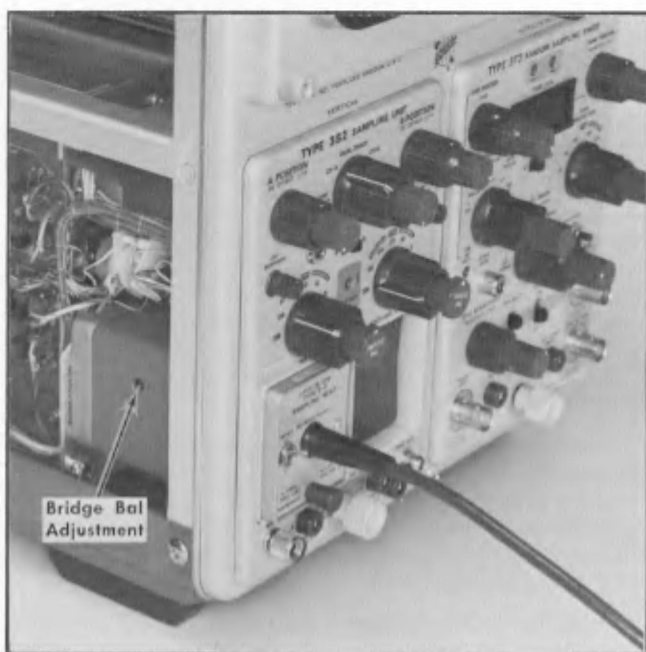

Fig. 2-7. Bridge Bal Location.

from the CRT (or digital unit) to know the risetime of the signal.

Signals with risetime faster than about 0.8 ns can best be measured using a Tektronix Type S-2 Sampling Head. However, fair approximations of risetime can be made using the Type S-3 and calculating the signal risetime by formula (1) below. Formula (1) is based upon both the signal and the sampler having Gaussian risetime characteristics. The Performance Check and Calibration Procedure gives equipment, procedure and typical displays of the Type S-3 risetime when driven by a 70 ps risetime signal.

Formula (1)

$$T_r (\text{Displayed}) = \sqrt{(\text{Signal } T_r)^2 + (\text{Type S-3 } T_r)^2}$$

$$\text{Signal } T_r = \sqrt{(\text{Display } T_r)^2 - (\text{Type S-3 } T_r)^2}$$

Triggering the Sampling System

The Type S-3 has no internal trigger pickoff system. Therefore, an external trigger signal must be supplied to the sampling sweep unit. If the signal being measured is a repetitive sine or square wave, a pretrigger is not required. Viewing the leading edge of a fast pulse signal does require a pretrigger, or use of the random process sampling possible with the Type 3T2. Two trigger pickoff devices for 50 Ω source impedance are described.

CT-3 Signal Pickoff. (Tektronix Part No. 017-0061-00.) A convenient method of picking off a signal in a 50 Ω system. Sensitivity is 10% of the voltage under test into a 50 Ω load.

50 Ω Power Divider. (GR874-TPD. Tektronix Part No. 017-0082-00.) Can be used to supply 50% of the input signal as a trigger signal and 50% of the input signal to a 50 Ω load. Requires the use of the Type VP-2 and a 50 Ω termination. Its primary advantage is for use with sine waves of low amplitude (less than 0.1 volt) if CT-3 10% trigger amplitude is so low the sampling sweep unit doesn't trigger properly.

Connect the trigger signal from either trigger pickoff unit to the sampling sweep unit. Use a 2× attenuator to reduce trigger circuit reflections when using the GR874-TPD. Operate the sweep unit externally triggered. Random process sampling of the Type 3T2 constructs a display of a repetitive signal so that no delay line or pretrigger is required to view the leading edge of a fast pulse. Normal sequential process sampling requires a pretrigger signal to view the leading edge of a fast pulse signal. This can be obtained from some pulse generators with a pretrigger output signal, such as the Tektronix Type 284. Another method is to use a trigger pickoff device at the signal source ahead of a high fidelity delay line. The delay line provides a signal delay necessary to observe the leading edge of a fast pulse. The delay line method is described in the Performance and Calibration Section of this manual.

SECTION 3

CIRCUIT DESCRIPTION

Change information, if any, affecting this section will be found at the rear of the manual.

General Information

This section of the manual contains a block diagram analysis of the Type S-3 Sampling Head followed by a detailed circuit description. The Type S-3 is the signal input section of the sampling system, and determines the input characteristics of the sampling system. You may find it helpful to refer to the associated sampling unit manual for information on sampling principles if the purpose of a particular circuit is not clear. For example Type 3S2 manual, Section 3, "Basic Sampling Principles". The sampling unit manual also shows interconnections and circuits referred to in this section. Schematic and block diagrams of the Type S-3 are located at the rear of this manual.

BLOCK DIAGRAM

Strobe Generator

The Strobe Generator develops fast-rise short-duration push-pull pulses that drive the Sampling Bridge into balanced conduction. Output occurs at the time of each sample when a command pulse arrives from the Delay and Strobe Driver circuit of the associated sampling unit. Shape and amplitude of the output strobe pulses is set by the Avalanche Volts and Snap-off Current controls. Strobe pulse duration is fixed by the two shorted clipping lines.

Sampling Bridge

The Sampling Bridge allows no connection other than the normal stray capacitance of the bridge between the input connector and the Preamplifier input except when driven into conduction by the Strobe Generator. When the Strobe Generator drives the Sampling Bridge into conduction, a portion of the signal across the Sampling Bridge is applied to the Preamplifier input.

Reverse bias is applied to the Sampling Bridge diodes by the Bridge Volts and Bridge Balance circuit. The sampling system feedback signal and DC Offset voltage is applied to the output side of the Sampling Bridge and the Preamplifier input.

Preamplifier

The Preamplifier circuit both amplifies and time-stretches the signal it receives from the Sampling Bridge. The signal applied to the preamplifier is a portion of the difference between the combined feedback and DC offset voltage, and the input signal. The error signal is amplified and AC coupled to the post amplifier in the sampling unit. The Pre-

amplifier gain is adjustable to aid in setting the overall sampling head and sampling unit loop gain to unity for proper dot response displays.

CIRCUIT DESCRIPTION

The Type S-3 Sampling Head uses the power supplies of the indicator oscilloscope and associated sampling unit. Interconnections to some of the circuits in the sampling unit are by a connector at the rear of the sampling head. This Circuit Description covers the circuits in the Type S-3, and refers to circuits within the sampling unit. Reference to the sampling unit instruction manual diagrams and circuit description may be useful to fully understand the circuit relationships.

Strobe Generator

The Strobe Generator circuits are located on the Strobe board. The generator contains two basic circuits, the Avalanche circuit and the Snap-off diode circuit. Both circuits work together to produce the push-pull strobe pulses that drive the Sampling Bridge through two equal transmission lines. See Fig. 3-1.

Avalanche circuit. The Avalanche circuit converts the Strobe Drive pulse from the sampling unit to very fast push-pull pulses to drive the Snap-off diode to non-conduction.

The Strobe Drive pulse is transformer-coupled by T75 to the base and emitter of the Avalanche transistor Q69. Two outputs are AC-coupled from Q69, one from the collector and the other from the emitter. The Avalanche Volts control adjusts the collector voltage of the avalanche transistor Q69. The typical quiescent voltage at Q69 collector is about +15 volts. This voltage sets the amplitude of the signals that drive the Snap-off diode circuit, and assures the normal avalanche action of Q69 when driven by the Strobe Drive signal. Q69 current path is shown by a dashed line in Fig. 3-1. Before Avalanche conduction, there is a potential of about 60 volts between collector and emitter.

The negative Strobe Drive pulse is transformer-coupled by T75 to the emitter and the base of Q69, forward biasing Q69. Normal avalanche action follows with the collector going negative and the emitter going positive. This fast-rise push-pull signal is capacitively coupled to the Snap-off Diode circuit.

Snap-off circuit. The Snap-off circuit operates as a current switching circuit to apply some of the push-pull Avalanche signals at snap-off time to the Sampling Bridge.

The circuit consists of a Snap-off Current control R57, Q55, Snap-off diode D61, two clipping lines and associated components. Between drive pulses from the Avalanche circuit,

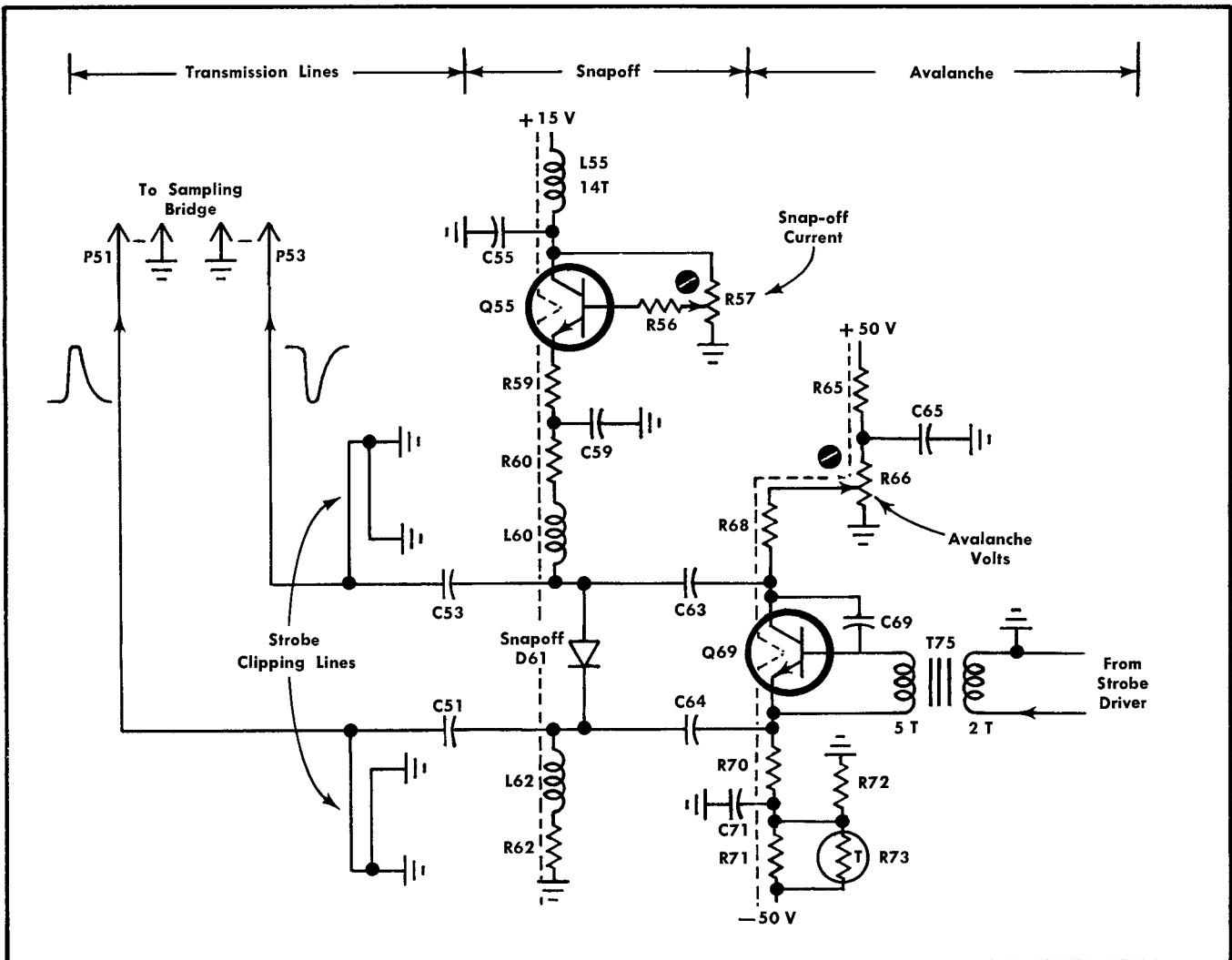

Fig. 3-1. Strobe Generator circuits.

the Snap-off diode D61 is forward biased by the current in Q55. The current value is set by the Snap-off Current control R57. The current in D61 is typically 20 mA, and the current path is shown as a dashed line in Fig. 3-1. This heavy forward current assures that D61 has many carriers within its junction region.

The push-pull signals from the Avalanche circuit cause D61 junction carriers to reverse direction as a heavy reverse current. This heavy reverse current stops suddenly as all the carriers clear out of the junction. As the reverse current "snaps" to a stop, the push-pull avalanche signals are suddenly coupled toward the clipping lines and the Sampling Bridge by C53 and C51. The fast-rise step which appears at each clipping line input is propagated down the line. A finite period of time later the steps reach the short circuit ends of each clipping line. The step is then reflected, equal in amplitude and opposite in polarity, back to the transmission line. This cancels the signals moving toward the Sampling Bridge. This action results in a positive Strobe pulse being delivered to P51, and a negative Strobe pulse being delivered to P53.

Sampling Bridge

The Sampling Bridge diodes A, B, C, and D are encapsulated as a single unit and shown as D4 in Fig. 3-2. These diodes are located within the body of the probe. The input signal, appearing at the probe tip, is applied across the series combination of R1 and R4. This 100 kΩ resistance together with the low value of input capacitance provide the Type S-3 with a relatively high input impedance. Capacitor C1 is in series with the stray capacitance at the input of the Sampling Bridge. The capacitance of C1 can be varied by rotating the body of the probe (See Operating Instructions, Section 2). Correct adjustment of C1 provides the proper division of high-frequency signal components across C1 and the stray capacitance in parallel with R4.

The Sampling Bridge is kept reverse biased except for short intervals (during sampling time) when it is driven into conduction by pulses from the Strobe Generator. During the conduction time of about 350 ps, current through the bridge increases or decreases the voltage on capacitor C30 at the gate of Q31. The voltage on C30 changes only a small percentage of the difference between the combined feedback

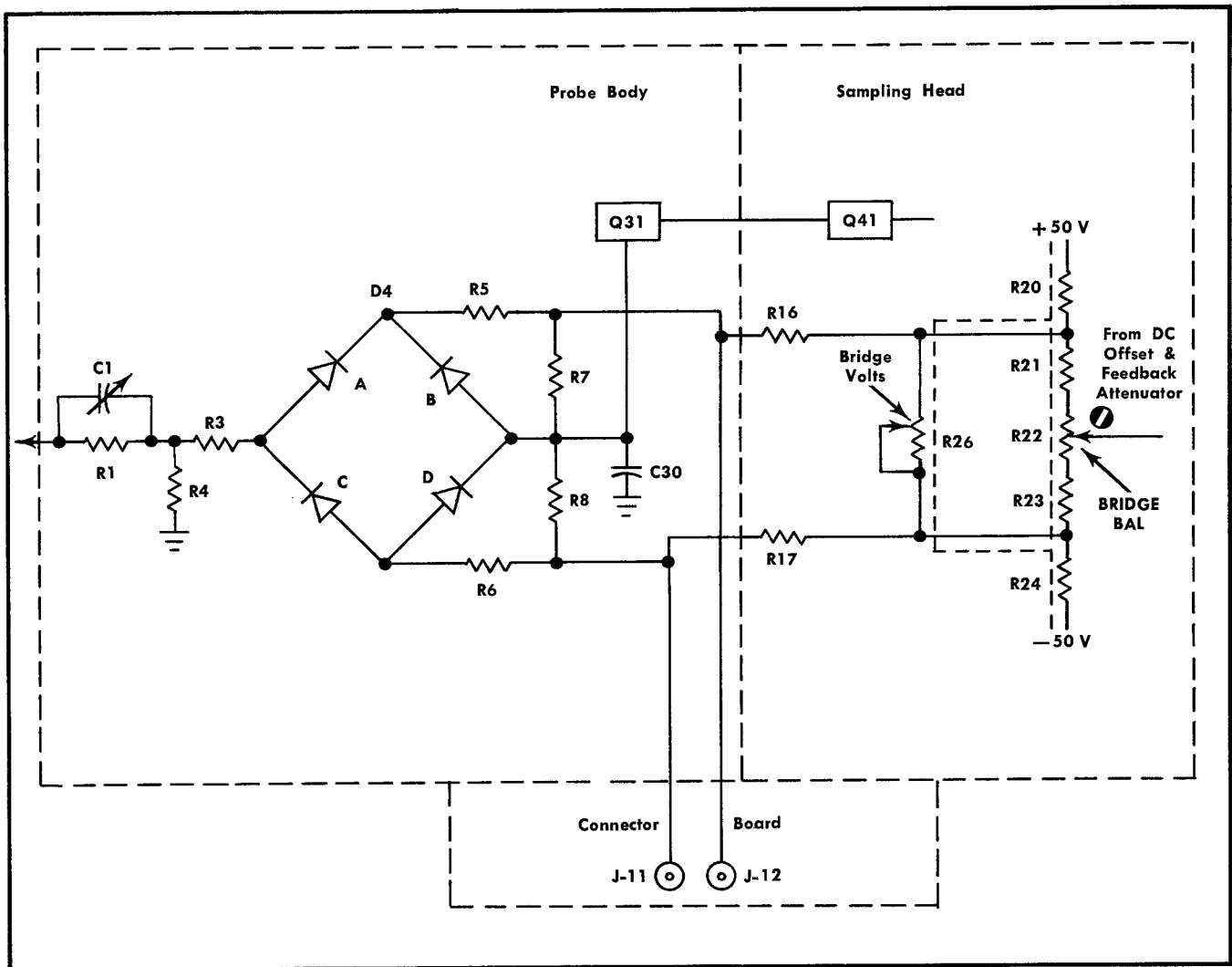

Fig. 3-2. Sampling Bridge circuit and Bridge Volts and Bridge Balance circuits.

and DC offset voltage and the incoming signal voltage due to the short bridge conduction time. This voltage change, called the error signal, is amplified by Q31 and the remainder of the preamplifier bringing the voltage on C30 up to the proper value, through the feedback circuit, prior to unblanking of the CRT.

Reverse-bias voltage for the sampling bridge diodes is developed across R21, R22, and R23 paralleled by R26, the Bridge Volts control. R26 allows adjustment of the reverse bias. A higher reverse voltage allows bridge conduction for a shorter time. A lower voltage provides a longer conduction time.

The Bridge Bal potentiometer is adjusted to compensate for diode, strobe, and other system unbalance signals. The combined memory feedback and DC offset voltage from the sampling unit is fed through the bridge volts circuit to the output of the Sampling Bridge.

Feedback and offset voltages are applied from the associated sampling unit to the movable contact of the Bridge Bal control R22. A switch on the front panel of the Type

S-3 Sampling Head permits selection of either of two ranges of offset voltage. See Fig. 3-3. With the OFFSET switch at the $\times 2$ position, up to 2 volts of offset voltage of either polarity is available for application to the sampling bridge. With the switch set to the $\times 1$ position up to 1 volt of either polarity can be applied.

Preamplifier

The Preamplifier circuit (see Fig. 3-4) amplifies and time-stretches the error signal pulse from the Sampling Bridge, and AC couples it to the Post Amplifier in the associated plug-in unit.

Transistor Q31 operates as a very high impedance high-gain inverting amplifier. C34 assures that Q31 has a high AC gain, while the DC gain is less than 1.

Q41 and Q45 are connected as an operational amplifier with a very low output impedance at Q45 emitter. The output is coupled by C49 to the $90\ \Omega$ input resistance Post Amplifier in the sampling unit. Q45 current paths are shown by

Circuit Description—Type S-3

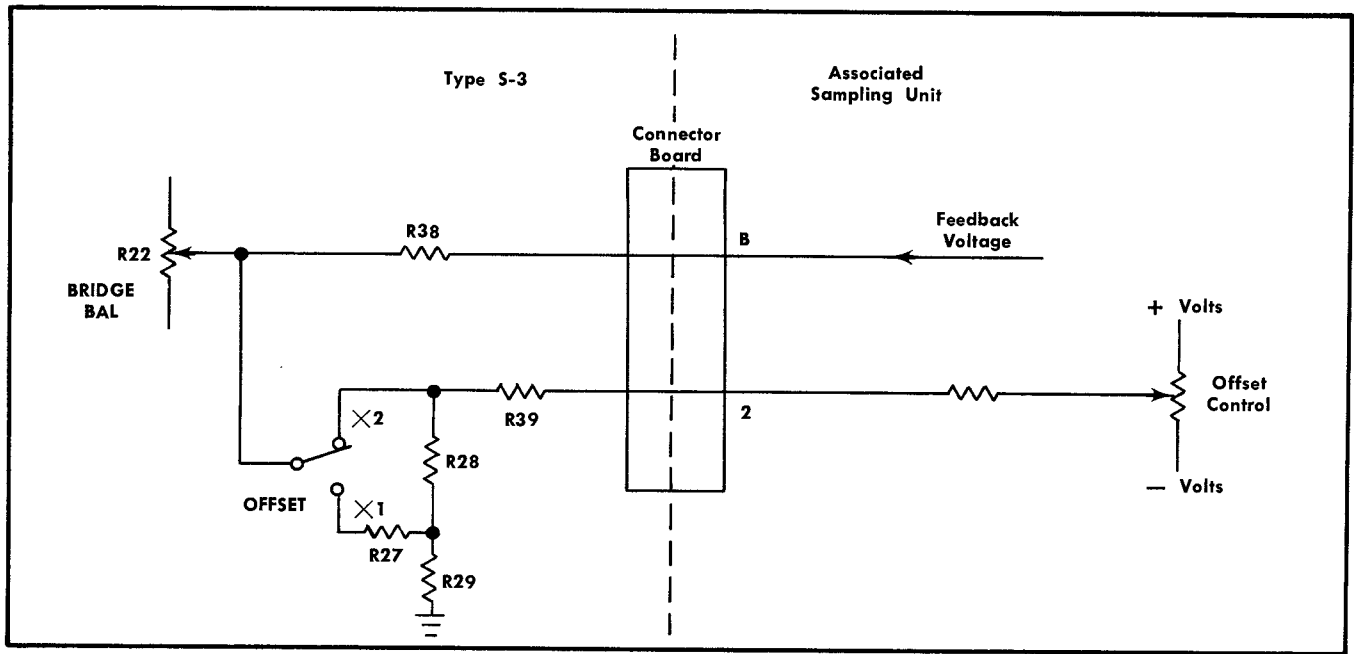

Fig. 3-3. OFFSET range switch and associated circuit.

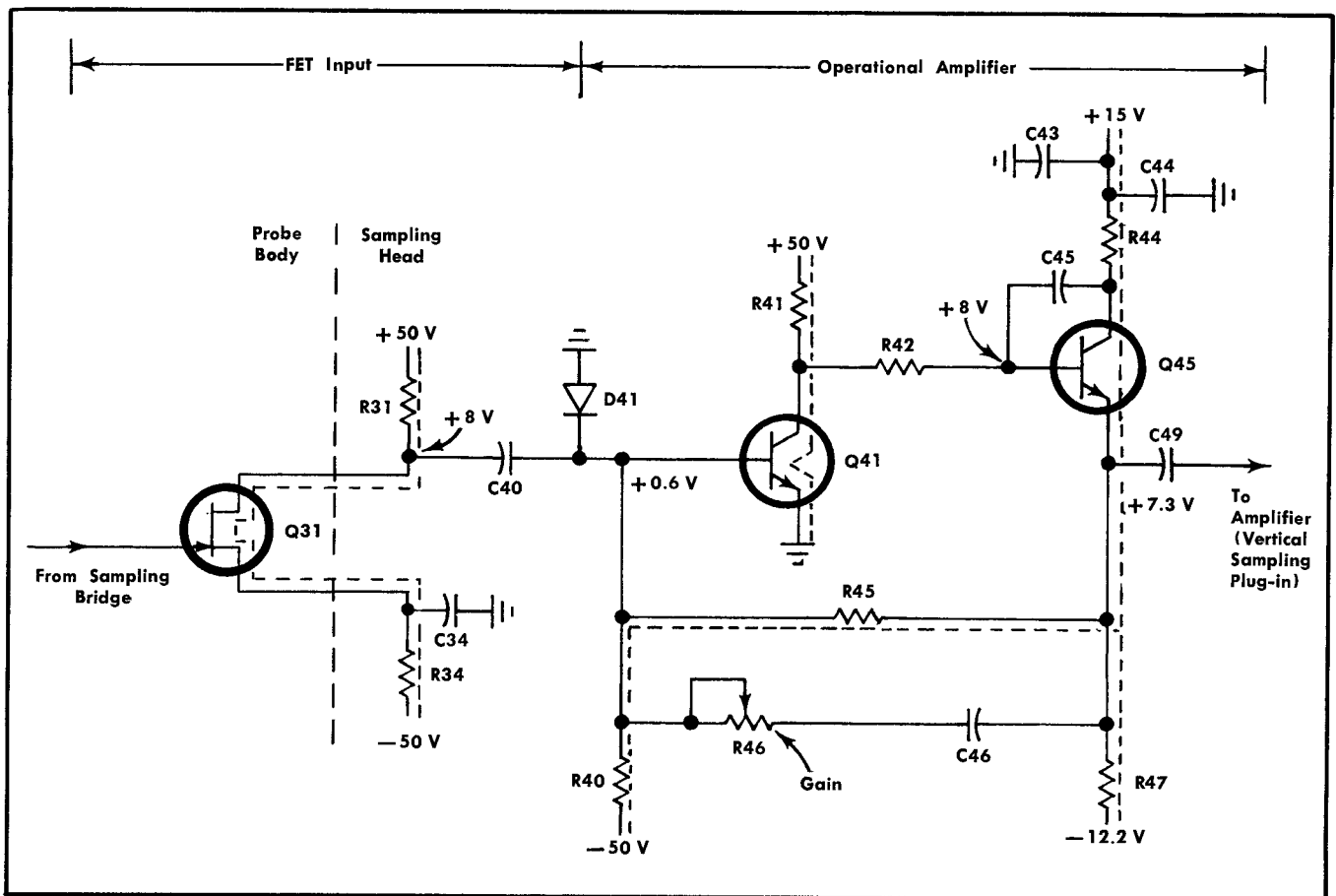

Fig. 3-4. Preampifier circuit.

dashed lines in Fig. 3-3. D41 protects Q41 base from high negative voltage if Q45 is removed from its socket while the power is on.

Current in R40 with DC negative feedback by R45 sets

the output DC voltage level of the amplifier at about +7.3 volts. Negative AC feedback from the emitter of Q45 through C46 and Gain control R46 to Q41 base controls the AC gain of the Preamplifier. The Gain control R46 allows the AC feedback to be adjusted, thereby adjusting the gain.

SECTION 4

MAINTENANCE

Change information, if any, affecting this section will be found at the rear of the manual.

Introduction

This section of the manual contains information for use in corrective maintenance or troubleshooting of the Type S-3.

To remove the Type S-3 from its case, loosen the four retaining screws on the back. Then slide the back off, and remove the case by sliding it to the rear. Directions for replacing the case on the sampling head will be found at the end of this section.

Parts Replacement

All parts used in the Type S-3 can be purchased directly through your Tektronix Field Office or Representative. However, replacements for standard electronic items can generally be obtained locally in less time than is required to obtain them from Tektronix. Replacements for the special parts used in the assembly of the Type S-3 should be ordered from Tektronix since these parts are either manufactured or selected by Tektronix to satisfy a particular requirement. Before purchasing or ordering, consult the Electrical or Mechanical Parts List to determine the value, tolerance and ratings required.

NOTE

When selecting the replacement parts, it is important to remember that the physical size and shape of a component may affect its performance at high frequencies. Parts orientation and lead dress should duplicate those of the original part since many of the components are mounted in a particular way to reduce or control stray capacitance and inductance. After repair, the sampling head may require recalibration.

Transistor Replacement. Cut the leads of a replacement transistor to the same length as the transistor removed and bend the leads as necessary. The lead configurations of the transistors used in the Type S-3 are shown in Fig. 4-1. The field-effect transistor, Q31, which is located in the probe body, has leads soldered to the circuit board.

Leadless Capacitors. There are leadless ceramic capacitors soldered directly to the circuit boards. Care must be taken when replacing these capacitors as they are easy to crack. The type of solder used must be high quality, with good cold-flow characteristics. Thus, do not use 50/50 solder, but 60/40 or 62/38 solder when replacing the leadless capacitors.

Best results will be obtained by applying heat from the soldering iron directly under the leadless capacitor on the opposite side of the board. Usually a plated-through hole is under the leadless capacitor, allowing solder to conduct heat through the board. Without plated-through holes, the capacitor may be soldered into place by positioning the part, then applying heat to the adjacent plated area.

Use only enough solder to obtain a good full-flow joint. Excess solder on either side of the capacitor can lead to a shorted circuit.

Removal and Replacement of Snap-off Diode. The Snap-off diode is mounted in small metal clips, as shown on the circuit board illustration. The diode is best removed or replaced with a pair of shaped plastic tweezers, such as Tektronix Part No. 006-0765-00, or equivalent.

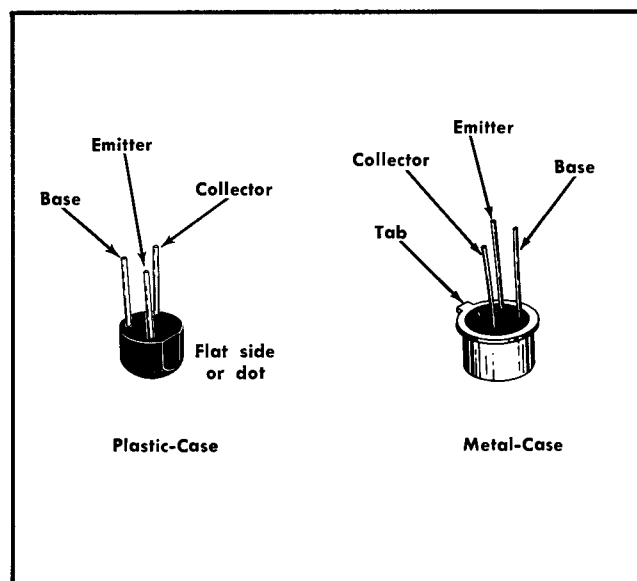

Fig. 4-1. Lead configuration for board-mounted transistors.

Circuit Board Replacement. If a circuit board is damaged and cannot be repaired, the entire assembly including all soldered-on components should be replaced. The part number given in the Mechanical Parts List is for the completely wired board.

The Preamp Board and the Strobe Board are removed by gently pulling outward from the Terminal Board. To replace the boards, align the connectors and pin contacts and ease the boards into position. Pin connectors should not protrude beyond the clamps. Solder the three leads to the Preamp Board.

The Terminal Board is removed as follows:

1. Remove both the Preamp Board and the Strobe Board.
2. Remove the front panel by removing the locking nut on the OFFSET switch (10⁵/₁₆" nutdriver) and the phillips head screw.
3. Keep the white plastic circuit board holders straight while loosening the screws at the front of the sampling head.

Maintenance—Type S-3

4. Disconnect and unsolder leads from the probe cable and the Terminal Board is free.

Probe Care

The probe should be inspected before further use any time it has been dropped or damaged. To inspect the inside of the probe, grasp the cable strain-relief boot about $\frac{3}{4}$ inch from the probe body, then turn the coupling nut clockwise about three turns and the probe body counterclockwise about six complete turns. This frees the securing threads and allows the body to be removed from the tip end.

The cable strain-relief boot can be moved back from its normal position by turning clockwise when the probe body is installed.

If any parts require replacement, it is recommended that you send the probe to the nearest Tektronix Field Repair Center.

CAUTION

Use extreme care in soldering on the probe circuit board. Ground the metal on the probe body to the same potential as the soldering iron to avoid electrical shock to the sampling diodes (D4.) Use heat sinks to avoid heat damage. Careful handling is needed to prevent physical damage to the small part. Use 60/40 or 62/38 solder and a miniature

soldering iron (Tektronix Part No. 003-0338-00) with tweezers as a heat sink. Excessive heat may expand the epoxy coating on the diodes and cause damage to internal connections within the device.

Replacing the Cable Assembly

If the coaxial cable between the probe body and sampling head should fail a replacement cable assembly (with attached new probe) is available. Replace the cable as follows:

1. Remove the case by unscrewing the four rear Phillips head screws. Slide the case off the back of the unit.

2. Remove the small screw at the right center of the front panel and the nut from the toggle switch at left center of the front panel (use a $\frac{5}{16}$ " open end wrench) and remove the front panel.

3. Carefully remove the two outer circuit boards taking note of how the OFFSET switch is placed. Do not lose the black plastic spacer that is now loose on the threaded portion of the switch.

4. Remove the two flat-head Phillips screws holding the center circuit board to the front panel casting.

5. Withdraw the two strobe cable coaxial connectors and unsolder the two leads and grounding braid from the center board.

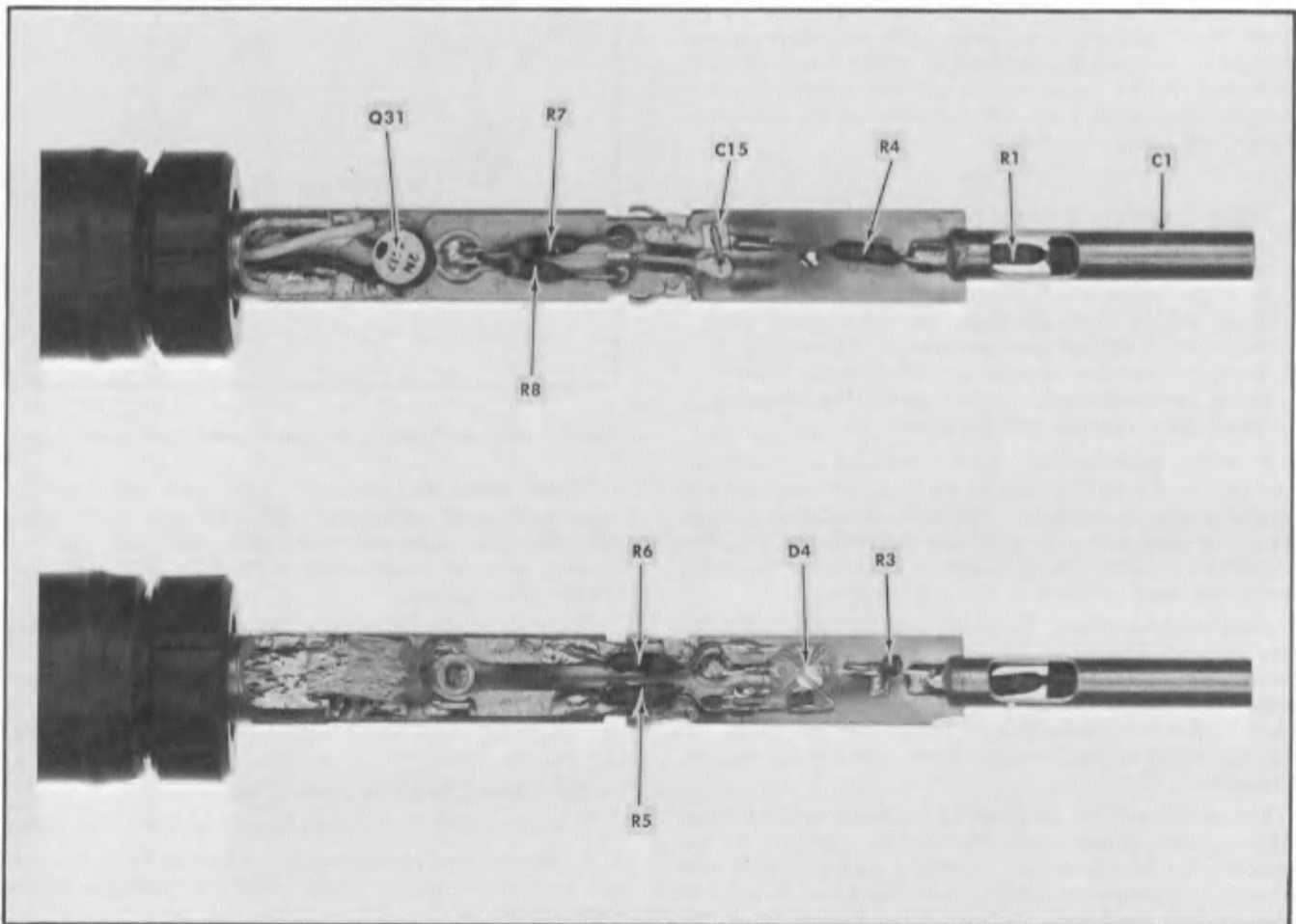

Fig. 4-2. Type S-3.

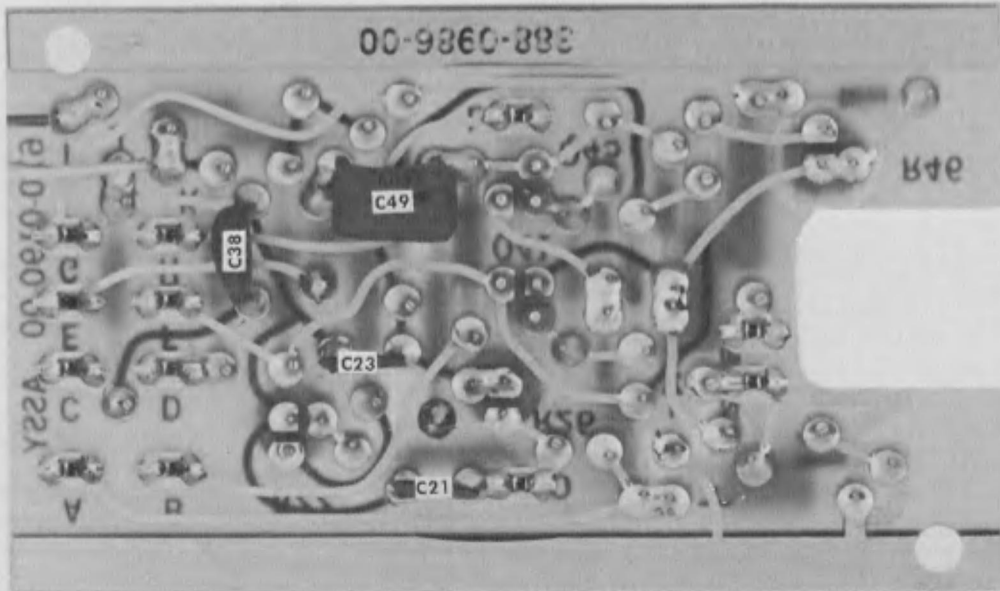
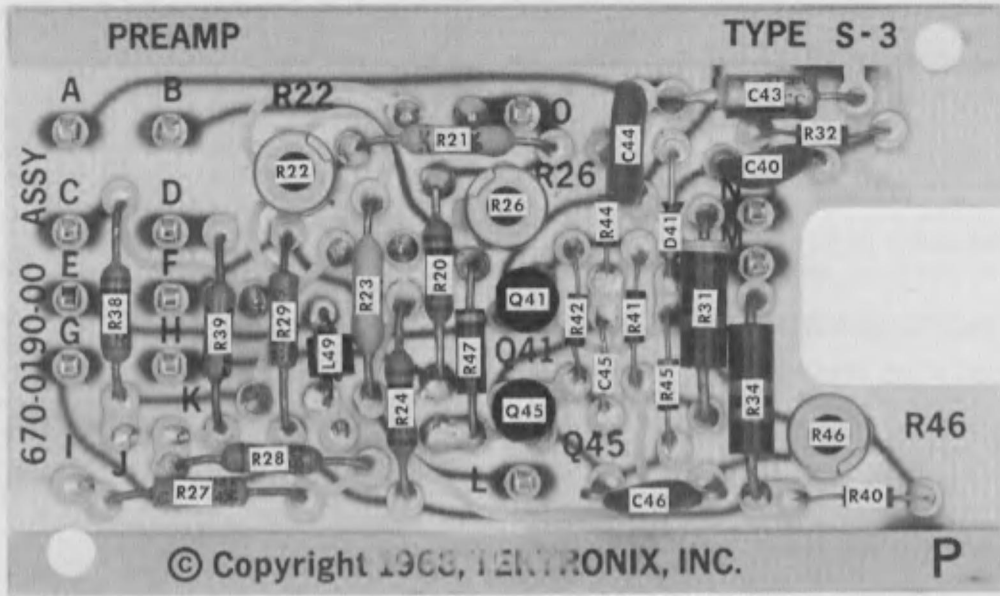

Fig. 4-3. Preamp circuit board.

Maintenance—Type S-3

6. Loosen the two round-head Phillips screws that hold the two white plastic clamps on the cable end and remove the cable assembly.

7. Place the new cable assembly in the white plastic clamp with the clear (transparent) covered coaxial cable above the red covered cable and tighten the two round-head Phillips screws.

8. Connect the white wire to upper, black wire to center and shield to the lower terminals at the front of the circuit board.

9. Connect the red covered coaxial cable to the lower connector and the clear (transparent) covered coaxial cable to the upper connector.

10. Complete reassembly of the unit by using procedure the reverse of that used during disassembly.

TROUBLESHOOTING

Mechanical design of this sampling head is such that circuit boards are interchangeable from one unit to another (the probe circuit board is not replaceable). Since the outer boards are easily removed and replaced, it is possible to quickly troubleshoot a faulty sampling head by interchanging boards with an operating one. Thus, removal of the preamp board from a defective unit and replacement with one from an operating unit quickly checks the faulty unit's preamp circuits.

Attempt to isolate trouble to one circuit through operational and visual checks. Verify that the trouble is actually a malfunction within the Type S-3, and not improper adjustments or malfunctioning associated equipment. Note the

effect control adjustments have on the trouble symptoms. Normal or abnormal operation of each control helps establish the location and nature of the trouble.

Check the instrument calibration procedure given in Section 5, and note the position of each control so it can be returned to its original position after the check. This will facilitate recalibration after the trouble has been found and corrected.

A block diagram and schematic diagram are included in Section 8 of this manual. It is usually best, if the trouble is not isolated to a circuit, to start by checking the power supplies of the sampling unit; see Table 4-1, then proceed consecutively from one circuit to the next.

TABLE 4-1

Test Point Pin		Power Supply (Decoupled)	Tolerance
Preamp Board	Strobe Board		
G	B	+50 V	± 1 V
A	A	+15 V	± 0.15 V
F	C	-50 V	± 0.5 V
B	—	-12.2 V	± 0.37 V

CAUTION

Use care when measuring voltages or signals. The small size and high density of components in this instrument establishes a condition such that an inadvertent movement of the test probe or the use of oversized probes may cause a short-circuit between components.

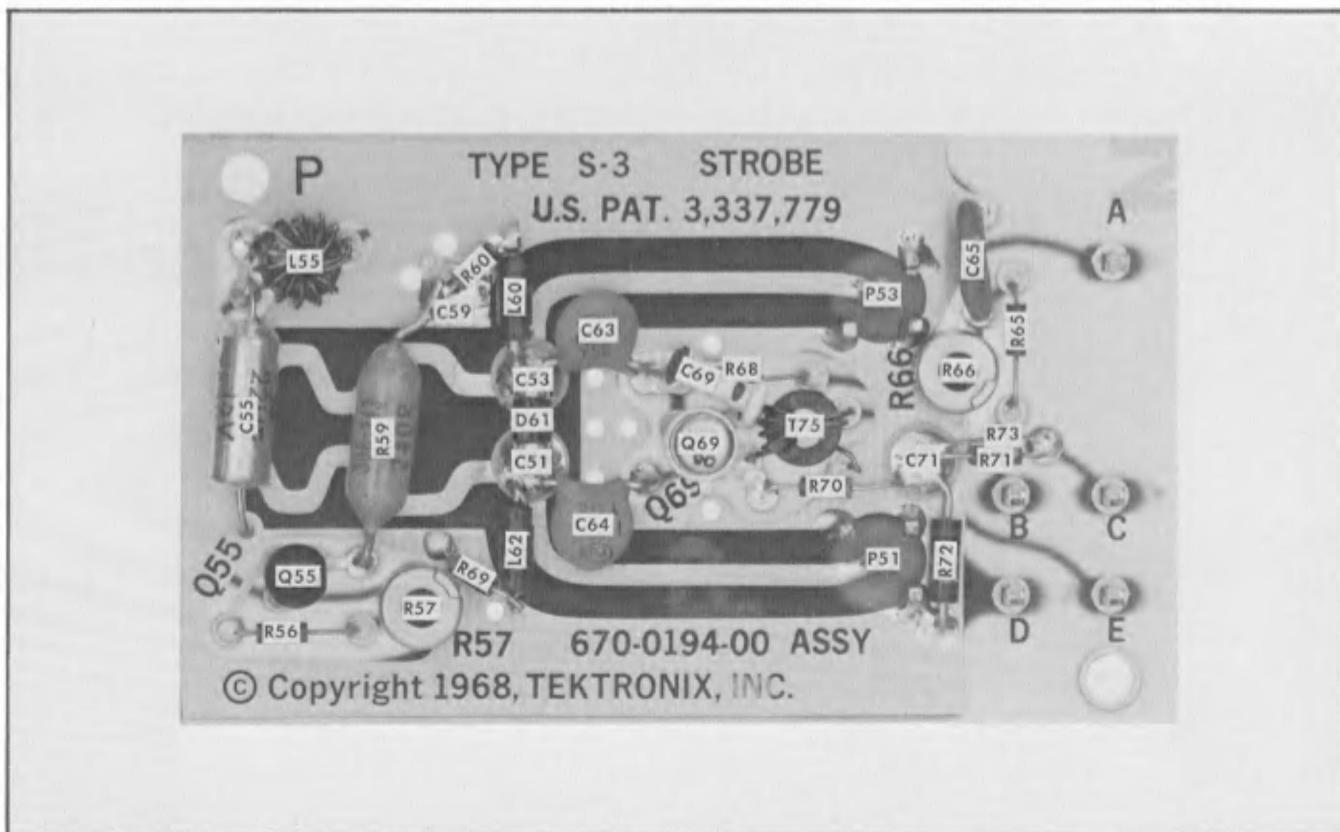

Fig. 4-4. Strobe circuit board.

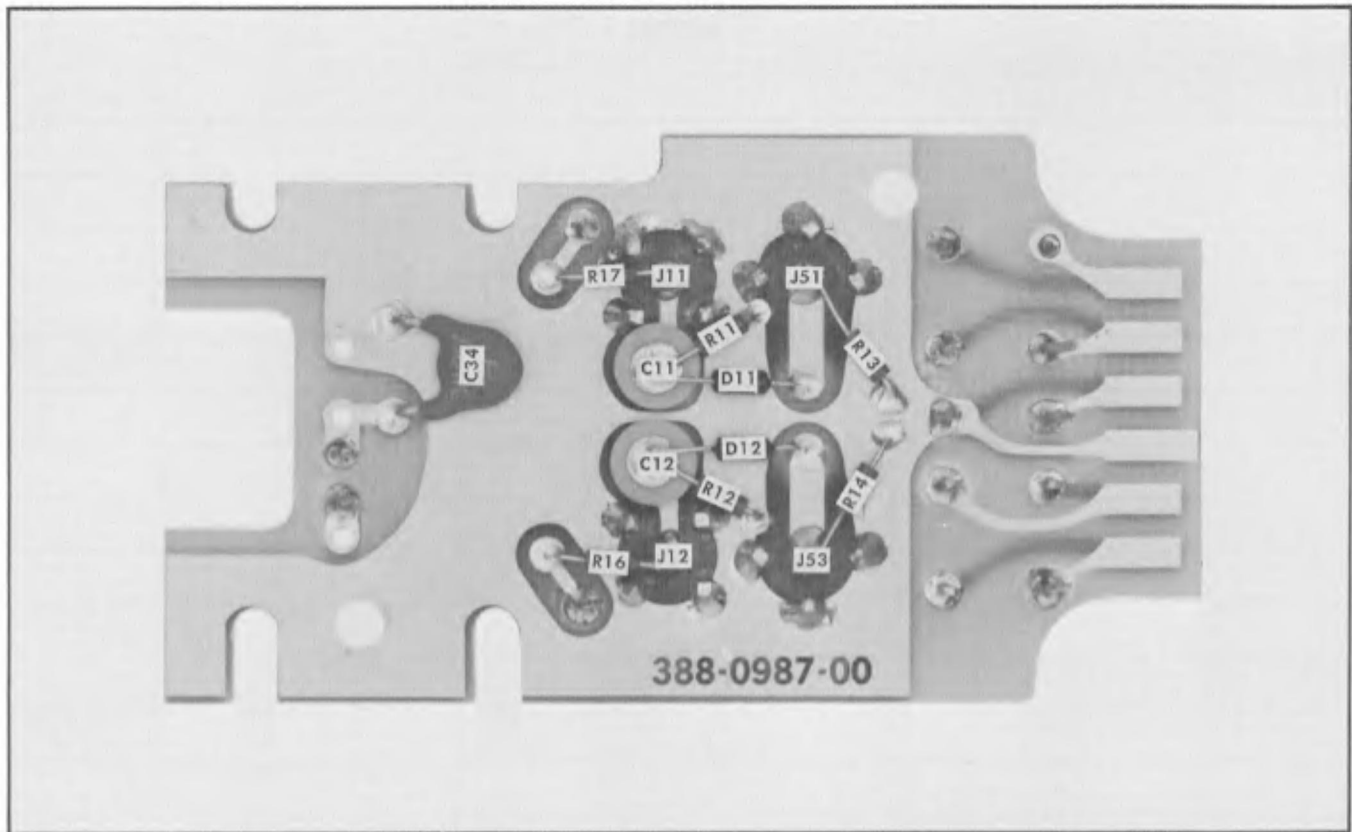

Fig. 4-5. Terminal circuit board.

Major Circuit and Parts Locations

The remainder of this section includes photographs of sections of the Type S-3. Major circuit areas are identified. All components mounted on circuit boards are identified by circuit number.

Replacing the Sampling Head Case

To replace the case on the sampling head, align the body so that the hole in the side will appear over the Bridge Bal control (R22 located on the left side). Check that the upper

and lower corners of the Preamplifier and Gate Generator boards are aligned with the channels in the sampling head body which contain the zigzag springs. Push the body gently forward until it contacts the front panel. Be sure that the white plastic pawl on the locking knob is properly aligned as the sampling head unit is slid into the case. In attaching the rear casting, be sure that the hole at one side of the casting is at the bottom of the Type S-3. Insert the four long mounting bolts and tighten them securely. Check that the center board is centered in the rear casting opening so the head can be properly inserted into the sampling unit.

SECTION 5

PERFORMANCE CHECK / CALIBRATION

Change information, if any, affecting this section will be found at the rear of the manual.

Introduction

The following procedure may be used as a check of the sampling head performance, or as a complete calibration procedure. When only the Performance Check steps are done, the sampling head is checked to the "Performance" information given in Section 1 of this manual. When the calibration steps are also done, limits, tolerances, and waveforms are added as calibration guides for these steps, and not as sampling head specifications.

Since the sampling head functions as a part of the associated sampling unit, it is recommended that the performance checks for the sampling unit be performed just before these performance checks are made. Then, if the sampling unit requires calibration, that procedure should be performed before starting this procedure. It is recommended that the Type S-3 be calibrated in the sampling unit in which it will be used. Even though the following procedure is written using a Type 3S2, it can be easily adapted to use with either a Type 3S5 or Type 3S6.

The two procedures are identified by the type style used in the headings of each step. Performance Check steps are those identified in the type style used in the Introduction subheading. Calibration steps are headlined in the type style of Step 2 and the next sub-heading, Equipment Required.

EQUIPMENT REQUIRED

The equipment listed below or its equivalent is required for a complete check and calibration of the Type S-3 Sampling Head; see Fig. 5-1. The equipment listed is used in the following procedure. Equipment specifications given are the minimum necessary for the particular use of each item. All test equipment must be correctly calibrated. If other equipment is substituted, it must meet or exceed the limits stated below. If a pulse generator other than the Type 284 is used, fast pulse display characteristics may vary from those shown in this manual.

All equipment items listed, except items 20, 21 and 22 can be obtained by ordering through your local Tektronix Field Engineer or Representative.

1. Test oscilloscope. Bandwidth, DC to at least 20 MHz. Minimum deflection factor of 20 mV/div. Comparison Voltage for measurements. For example, a Tektronix Type 545B with Type W Plug-In Unit.

2. 1X Probe for use with test oscilloscope. Tektronix P6011 Probe recommended with the Type W Plug-In Unit. Tektronix Part No. 010-0190-00.

3. Indicator oscilloscope, such as a Type 561A or Type 564 Oscilloscope with proper sampling plug-in units such as the

Type 3S2 Sampling Unit and Type 3T2 Random Sampling Sweep. Or, a Type 568 Oscilloscope with the same vertical and horizontal plug-ins, and Type 230 Digital Unit if the sampling system is used with digital readout.

4. Special 3 foot flexible extender cable for operating the sampling head outside the sampling unit. Tektronix Part No. 012-0124-00 required except when using a Type 3S6 Programmable Sampling Unit.

5. Signal generator—pulse generator, such as the Tektronix Type 284 Pulse Generator used in this procedure. Pulse risetime ≤ 70 ps, at approximately 200 mV amplitude into 50 Ω , with a trigger signal available at least 75 ns in advance of the fast pulse. Square wave signals of 1 μ s period (1 MHz with 1-V amplitude accuracy of $\pm 0.5\%$) and 100 ns period (10 MHz) at 1 volt amplitude into 50 μ s. (If your Type 284 Leadtime switch is labeled 5 ns—50 ns, order modification kit, Tektronix Part No. 040-0487-00.)

6. Pulse generator. Amplitude into 50 Ω , 5 V and 50 V, risetime 250 ps, pulse duration about 20 ns or more. For example, Tektronix Type 109 Pulse Generator.

7. Square wave generator. Amplitude at least 12 V into 50 Ω . Repetition rate of 50 kHz. Risetime 12 ns or less. Tektronix Type 105 Square Wave Generator recommended.

8. Signal delay coaxial cable. Impedance 50 Ω ; delay: 80 ns; connectors, GR874. Tektronix Type 113 Delay Cable (60 ns) with a 20 ns RG213/U coaxial cable, Tektronix Part No. 017-0504-00, or four 5 ns coaxial cables, type RG213/U, GR874 connectors, Tektronix Part No. 017-0502-00.

9. 50 Ω amplitude calibrator. Output impedance 50 Ω ; voltage range 0.06 to 2.0 volts square wave; accuracy within $\pm 0.25\%$. Tektronix Calibration Fixture 067-0508-00. (If the repetition rate is 20 kHz, change C25 from a .005 μ F discap to a .0033 μ F discap.)

10. One 50 Ω 10X attenuator with BNC connectors, Tektronix Part No. 011-0059-00.

11. One 50 Ω 5X coaxial attenuator, such as GR874-G14. Tektronix Part No. 017-0079-00. Two 50 Ω 10X coaxial attenuators, such as GR874-G20. Tektronix Part No. 017-0078-00.

12. A special variable attenuator with GR874 connectors. It consists of a 100 Ω potentiometer across the 50 Ω line, and does not have a guaranteed response. Tektronix Part No. 067-0511-00.

13. 50 Ω voltage pickoff, Type VP-2. Tektronix Part No. 017-0077-01, supplied with the Type S-3.

14. Signal pickoff, Type CT-3. Trigger source output, 50 Ω . Risetime less than 0.4 ns. Tektronix Part No. 017-0061-00.

15. Two 50 Ω GR874 end-line terminations, Type GR874-W50B. Tektronix Part No. 017-0081-00.

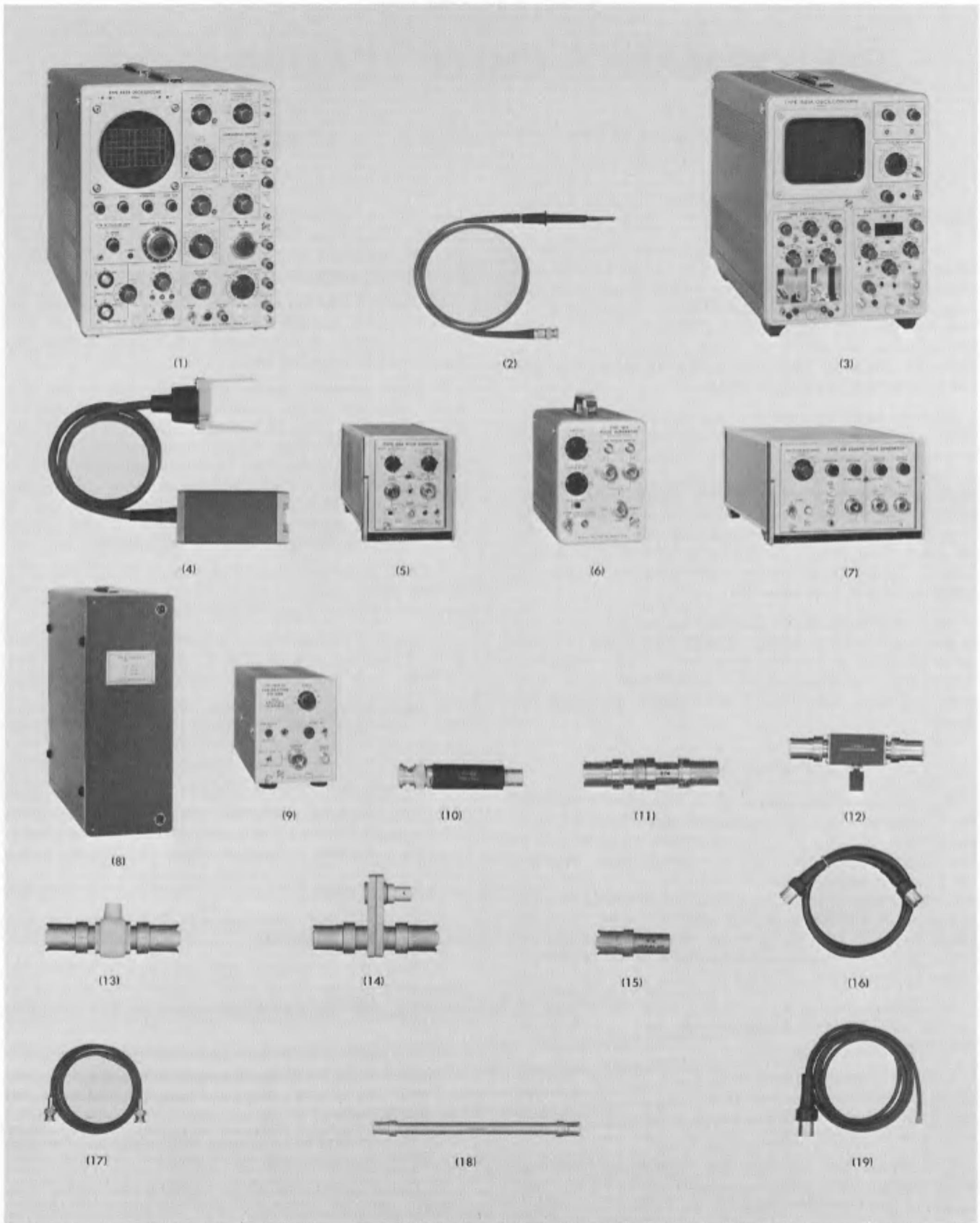

Fig. 5-1. Calibration Equipment.

16. 50 Ω coaxial cable, RG 58C/U, 5 ns signal delay, with GR874 connectors. Tektronix Part No. 017-0512-00.

17. 50 Ω coaxial cable, 5 ns signal delay, approximately 40 inches long, with BNC connectors. Tektronix Part No. 012-0057-01.

18. 50 Ω coaxial air line, 20 cm long, with GR874 connectors. GR874-L20. Tektronix Part No. 017-0084-00.

19. Charge line, 50 Ω 9 ns coaxial cable, checked, GR874 connector. Tektronix Part No. 017-0506-00.

20. DC bridge for measuring 100 kΩ and 1 MΩ. Plus or minus 100 volts DC maximum across 100 kΩ resistor. Accuracy, ±0.025% required. (Not shown.)

21. Small insulated handle, 3/32 inch bit screwdriver for adjusting screwdriver-adjust controls. (Not shown.)

22. An RMS reading line voltage meter, with a ±3% accuracy at the line voltage to which the indicator oscilloscope is connected. (Not shown.)

23. Bench multimeter, 20,000 ohm/volt, such as Simpson 262 or Triplett 630-NA. (Not shown.)

24. Type S-1 Sampling Head (not shown).

PERFORMANCE CHECK AND CALIBRATION RECORD AND INDEX

The following abridged procedure may be used as a guide by the experienced technician for checking and/or calibrating the Type S-3 Sampling Head. The abridged procedure can be used as a maintenance record (the procedure may be reproduced without special permission of Tektronix, Inc.). The step numbers and titles are identical to those in the complete procedure.

Sampling Head Type S-3, Serial No. _____

Calibration Date _____

Calibrated By _____

Checked By _____

- 1. Check for Operation and Ability To Produce a CRT Display (Page 5-4)
- 2. Check For Q69 (Avalanche) Operation (Page 5-4)
- 3. Check Probe Compensation (Page 5-5)
- 4. Check Risetime (Page 5-8)
- 5. Adjust Risetime (Page 5-10)
- 6. Check Loop Gain Linearity (Page 5-11)
- 7. Preliminary Bridge Bal Adjust (Page 5-12)
- 8. Check Pulse Flatness Deviation (Page 5-12)
- 9. Final Bridge Bal Adjust (Page 5-15)
- 10. Check Tangential Noise (Page 5-15)

11. Check Offset Accuracy (Page 5-16)

12. Check Deflection Factor Accuracy (Page 5-17)

PRELIMINARY PROCEDURE

1. Check the Type S-3 probe DC input resistance. Remove the sampling head from the sampling unit, remove the case and the Preamp circuit board. Use a DC resistance bridge and measure the DC input resistance across the probe tip (without attenuator). Be sure the bridge does not apply more than 100 V DC to the probe tip.

The probe input resistance must be 100 kΩ, ±0.25%.

Install the 10× attenuator on the probe and measure the input resistance across the attenuator tip. The 10× attenuator input resistance (when mounted on the probe) must be 1 MΩ, ±1%.

Remove the 10× attenuator tip and install the 100× attenuator on the probe. Measure the input resistance across the tip. Input resistance must be 1 MΩ, ±1%.

If any parts within the probe body or attenuation require replacement, it is recommended that you send your probe to your nearest Tektronix Field Repair Center.

Complete any needed repairs to the sampling head before proceeding. Replace the Preamp circuit board. The case should remain off for the Calibration procedure.

2. Connect the Type S-3 Sampling Head and oscilloscope system. This step discusses the assembling of test equipment, 5-minute warmup period, and setting of the sampling unit Gain and the sampling sweep Horiz Gain controls.

a. Assemble the indicator oscilloscope system. Place the sampling unit into the left compartment of the indicator oscilloscope, and the sampling sweep unit into the right compartment. Install an **operating** sampling head into the sampling unit Channel B compartment. Leave the Channel A compartment vacant. (If using a digital unit, make the interconnections to the indicator.)

b. Connect the RMS line-voltage meter to the power mains. Determine that the oscilloscope (and other equipment) power supply is set for the correct value of line voltage. Connect all the equipment to the proper power outlet and turn on the power. Obtain a free-running trace and let the equipment warm up for five minutes.

c. After the warmup period, adjust the indicator oscilloscope Trace Alignment control so the free-run trace is parallel to the graticule lines.

d. Connect the Type 284 Pulse Generator Square Wave Output to the operating Channel B sampling head input. Connect the Trigger Output to the sampling sweep unit Trigger Ext Input (50 Ω) through a BNC 50 Ω coaxial cable.

Adjust both the vertical and the horizontal unit Gain controls for proper deflection factor of each unit. Use the Type 284 100 ns period square wave as both time and amplitude reference.

Performance Check/Calibration—Type S-3

e. Install the sampling head to be calibrated onto the special three foot extender cable and the extender into the Channel A compartment of the sampling unit. Set the OFF-SET switch to $\times 1$. Allow a five minute warmup of the system. For a Performance Check, install the sampling head into the Channel A compartment without the extender.

PERFORMANCE CHECK AND CALIBRATION PROCEDURE

1. Check Operation and Ability to Produce a CRT Display

a. Connect the Type 284 Square Wave Output signal through a VP-2 voltage pickoff with a GR874-W50B 50 Ω termination to the Type S-3 probe.

b. Set the sampling unit controls for a Channel A display. Perform calibration step 2 if there is no display.

2. Check For Q69 (Avalanche) Operation

a. Remove the extender cable from the sampling head (the indicator oscilloscope power may be left on).

b. Remove the sampling head case. First, remove the four round-head screws visible at the back of the unit; then, slide the cover off by gently pulling it away from the front casting and probe.

c. Reconnect the extender cable to the rear of the sampling head. Use the signal set-up of step 1.

d. Use the test oscilloscope with $1\times$ Probe, to check for proper operation of Q69. The probe connections are shown in Fig. 5-2, and the general nature of the signals is shown in Fig. 5-3. Fig. 5-3A and B show the general amplitude for Q69 collector and emitter signals. Fig. 5-3C shows the typical drive signals at T75 primary (square terminal E of Strobe board) while the head is on the extender cable.

If T75 is receiving drive, but there is no signal out of Q69, change Q69 (changing Q69 may significantly increase

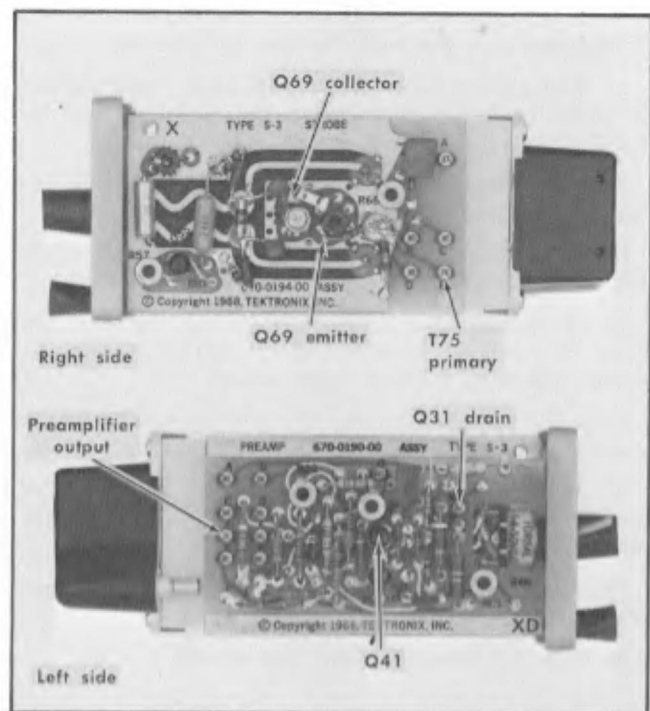

Fig. 5-2. Test point locations for step 2.

the displayed noise, so it is best to have several transistors of this type on hand and grade them for low noise using step 10). If all signals of Fig. 5-3 are present, check the Pre-amplifier output (square terminal E of Preamp board). If there is no signal at the Pre-amplifier output, check the sampling diodes and Q31 in the following manner.

(1) Pull Q41 from its socket. Set the Type 3S2 DC Offset control for zero volts measured at the front panel Offset jack. Free run the sampling sweep unit. Use the test oscilloscope, with $10\times$ probe, and monitor the drain lead of Q31 (square terminal N).

(2) Q31 will have a pulse signal at each strobe time if the transistor is operating. If there is no pulse signal, change Q31, re-install Q41 and try to obtain a trace.

NOTE

Q31 is located on the probe body circuit board. Use extreme caution in removal and replacement; use only a small, low-wattage soldering iron and a heat sink. Use tweezers to avoid physically damaging the transistor.

(3) If Q31 is operating, and if there is a pulse of either polarity at its drain lead (with Q41 out), operate the Bridge Bal control (R22) through its range. As R22 is changed, the pulse signal should reduce to zero and change to the opposite polarity. If the pulse signal does not change polarity, one of the sampling diodes is open.

CAUTION

Since the sampling diodes are very delicate, extreme care is required in soldering them. Use proper heat sinks, and avoid the possibility of electric shock to the diodes.

(4) Restore Q41 to its socket. Once a display is obtained, go on to Step 5.

3. Check or Adjust Probe Compensation

Requirement—Optimum flat top of a 1 μ s period square wave.

Probe Only

a. Connect the Type 284 Square Wave output to the VP-2 voltage pickoff with the GR874-W50B 50 Ω termination installed. Connect the Type S-3 probe to the VP-2. Connect the Trigger Output to the sampling sweep unit Ext Trig Input (50 Ω).

b. Set the Type 284 Square Wave Amplitude to 1 V and the Period switch to 1 μ s.

c. Set the sampling sweep unit for 500 ns/div (0.5 μ s/div). Obtain a stable display.

d. Check for a level top of the square wave; see Fig. 5-4. To compensate the Probe for a flat top on the square wave display loosen the coupling (locking) nut, and rotate the probe body as necessary. When the correct display is obtained, finger-tighten the locking nut.

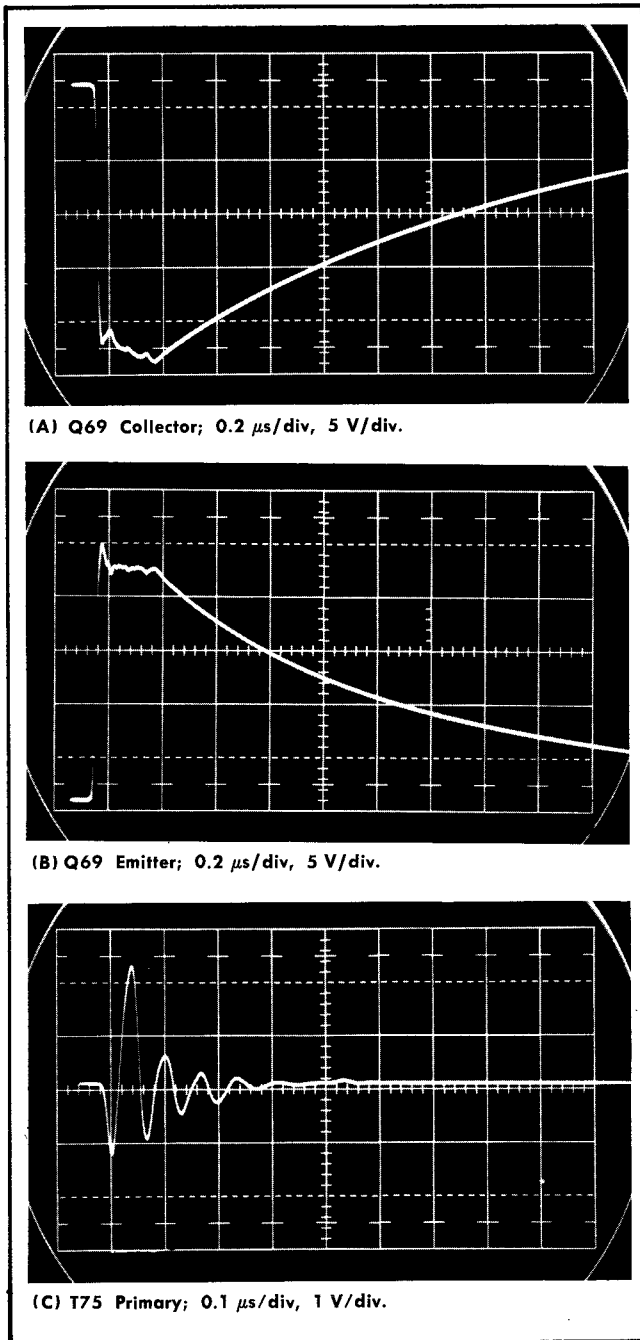

Fig. 5-3. Checking Avalanche drive and output.

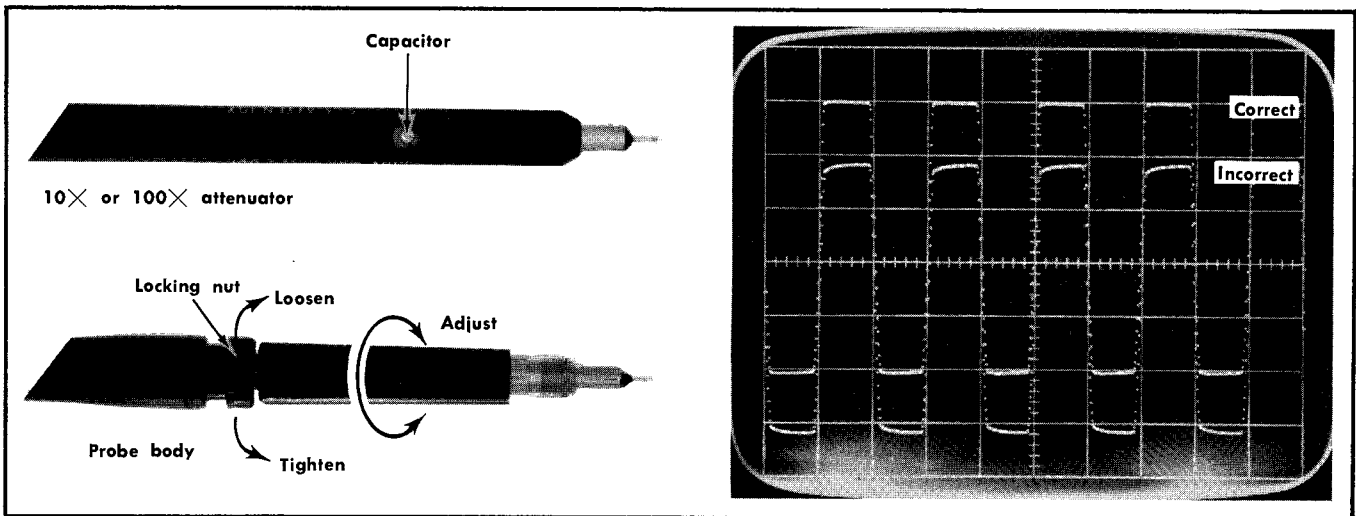

Fig. 5-4. Probe compensation.

10× Attenuator on Probe

e. Connect the Type 106 Hi Amplitude Output to the VP-2 voltage pickoff with the GR874-W50B 50 Ω termination installed. Attach the 10× attenuator to the Type S-3 probe and connect it to the VP-2. Connect the Type 106 Trigger Output to the sampling sweep unit Ext Trig Input (50 Ω) connector. Set the square wave repetition rate to 50 kHz.

f. Set the sampling sweep unit for a 2 μs/div sweep rate. Set the sampling unit Units/Div switch to 100 and adjust the Type 106 Amplitude control for a 5 division display. Use the sampling sweep unit Time Position controls to bring the square wave top into view.

g. Check for a level top on the square wave. If not level, compensate the 10× attenuator by carefully setting the capacitor (see Fig. 5-4), for a level top.

100× Attenuator on Probe

h. Remove the 10× attenuator and install the 100× attenuator.

i. Change the sampling unit Units/Div switch to 50 and set the Type 106 Amplitude control fully clockwise (maximum amplitude). Set the sampling unit Variable control for a 5 division display.

j. Check for a level top on the square wave. If not level, compensate the 100× attenuator by carefully setting the capacitor for a level top on the square wave.

k. Set the Type 106 Amplitude control fully counterclockwise and remove the probe from the VP-2.

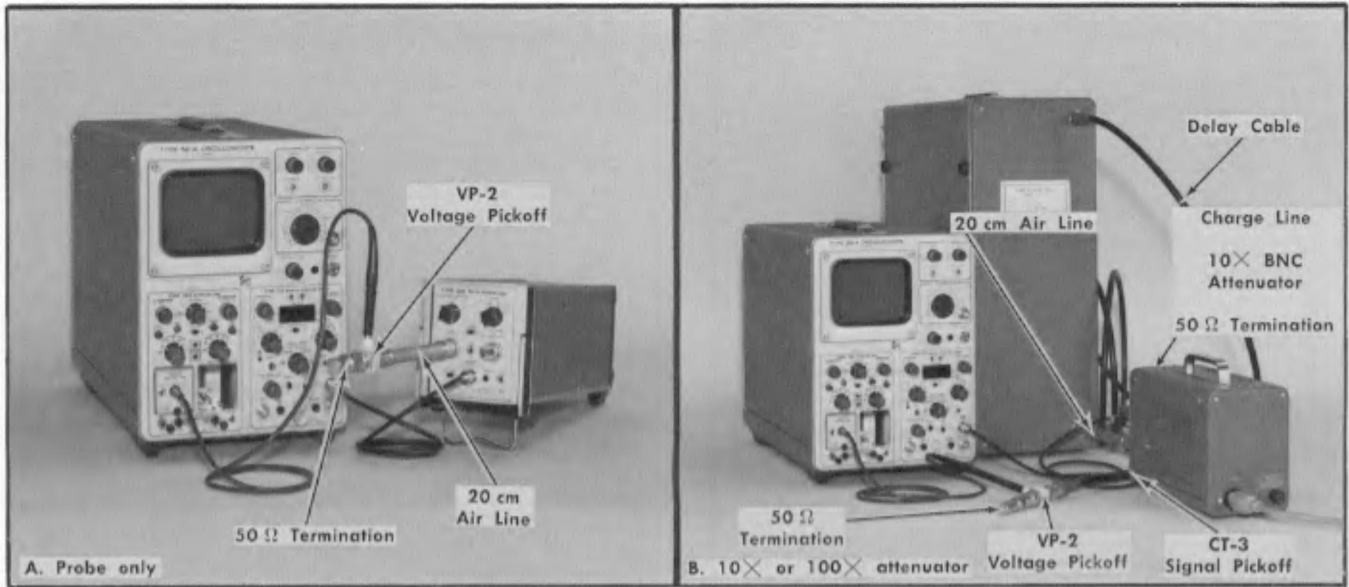

Fig. 5-5. Equipment setups to check risetime and pulse flatness deviation.

Control Settings

	Type 352	
Normal-Smooth	Normal	
Units/div	100	
Variable	Cal	
Mode	Channel A	
Trig Out	Optional	
Dot Response	Midrange	
Other Controls	Optional	
	Type 312	
Time Position	Fully clockwise	
Fine	Midrange for centered display	
Range	100 ns, } 200 ps/div	
Time Magnifier	×50	
Variable	Cal	
Display Mag	×1	
Start Point	With Trigger	
Display Mode	Normal	
Trigger Source	Ext	
Trigger Polarity	+	
Trigger Sensitivity	10 o'clock	
Recovery Time	Optional	
Internal Samples/Div	100	

Indicator Oscilloscope

Intensity	Normal display
Scale Illum	As desired

Type 284

Mode	Pulse Output
Other controls	Optional

Type 109

Amplitude	Fully clockwise
Voltage Range	5.0
Pulse Polarity	+

If a digital unit is used to measure risetime, set the controls as follows:

Type 230

Measurement Averaging	8
CRT Intensification	Both Ref Zones and Time Measurement on
Measurement Mode	Time
CH A Reference Zones	Both at Average
Channel switches	Both at A
Time Measurement Start Point Sw	10% Between Zones
Time Measurement Stop Point Sw	90% Between Zones
Slope	Both at +1st
Display Time	Midrange
Triggered Measurement	Off
Limits	Optional

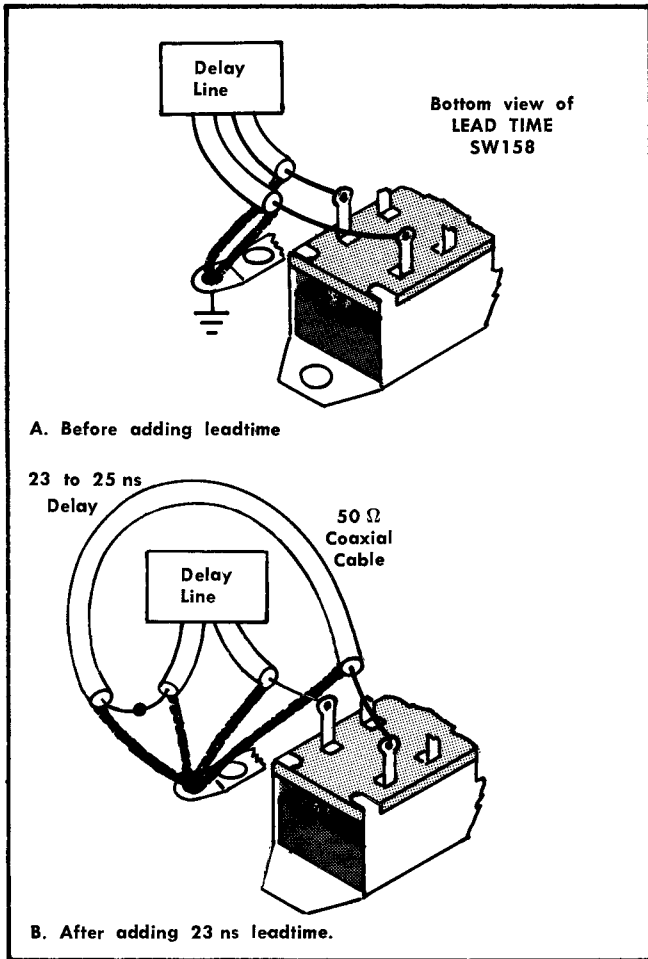

Fig. 5-6. Adding leadtime to an early model Tektronix Type 284 Pulse Generator.

NOTE

Instrument risetime can be checked either by visual measurement of the CRT display, or by a digital readout unit. Digital measurement of risetime requires that the Type 3T2 be operated in the With Trigger mode. With Trigger operation requires that the Type 284 trigger pulse have a leadtime of at least 73 ns before the fast Pulse Output signal. (Type 284 instruments with only 5 ns-50 ns Lead Time require the installation of Field Modification Kit, Tektronix Part No. 040-0487-00.)

CRT risetime measurement permits the Type 3T2 to operate in the Before Trigger (Random) mode, in which the trigger leadtime does not have to be 73 ns. The 73 ns stated here is required for the With Trigger mode when the sampling head is operating on a 3 foot extender cable and the trigger cable has a 5 ns signal delay. Less leadtime (about 70 ns) is required when the sampling

head is installed in the Type 3S2 and the trigger cable signal delay is only 2 ns.

Fig. 5-6 shows a substitute method of obtaining 73 ns trigger leadtime in an early model Type 284. If you install the recommended 23 ns signal delay cable shown in Fig. 5-6, operate the Type 284 with the case removed and adjust it as described in the following step.

4. Check Risetime

Requirement—Probe only: 10% to 90% risetime is equal to or less than 350 ps.

10 \times attenuator: 10% to 90% risetime is equal to or less than 400 ps.

100 \times attenuator: 10% to 90% risetime is equal to or less than 500 ps.

NOTE

This step follows Step 3, and is to be performed with the case on the sampling head. If Step 2 was performed, ignore this step and proceed to Step 5.

The portions of this step that check the attenuators risetime need not be performed unless there is a question about the individual attenuator. If one has been dropped, or electrically damaged, a check of its risetime can reveal whether it needs to be replaced. There is no adjustment in either attenuator that affects risetime. If an attenuator does not meet its risetime requirements, replace it with a new attenuator.

a. Use the equipment setup shown in Fig. 5-5A. The connections are as follows:

(1) Connect a BNC coaxial cable from the Type 284 Trigger Out to the sampling sweep unit Trigger Input (50 Ω).

(2) Connect the Type 284 Pulse Output to the 20 cm Air Line, the VP-2 voltage pickoff, then the GR874-W50B 50 Ω termination. Connect the Type S-3 probe to the VP-2.

b. Use the Type 3T2 Fine Time Position control to position the pulse rise as in Fig. 5-7A.

If a display cannot be positioned into view, turn the Time Position to midrange (pulse display is off the CRT to the left) and adjust the Type 284 TD Bias control. Start by turning the TD Bias control fully counterclockwise. This assures that there is no pulse output and the indicator oscilloscope trace should be positioned two divisions up from the lower edge of the graticule. Slowly turn the Type 284 TD Bias control clockwise to a midrange position that causes the indicator oscilloscope trace to jump about 5 divisions. (Repeat, so the control is at a position that just causes the trace to be up.) Set the Type 3T2 Time Position controls fully clockwise. If the indicator oscilloscope trace remains up 5 divisions without displaying a positive pulse, there is not sufficient

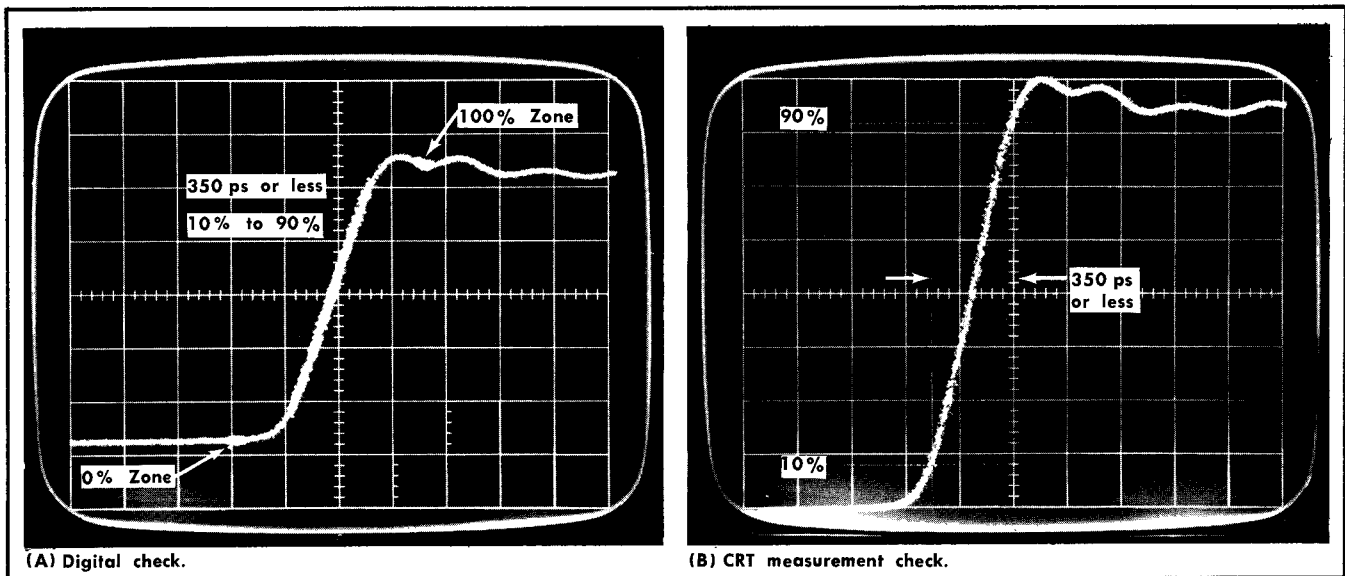

Fig. 5-7. Risetime measurement displays.

leadtime in the triggering signal path. Shorten the 5 ns signal delay cable to the Type 3T2 Ext Trig $50\ \Omega$ input connector to 2 ns signal delay, and try again. Or operate the Type S-3 in Channel B and use the B Delay control to gain more display leadtime. (An additional 2 ns trigger leadtime can be obtained by clockwise rotation of the Type 284 Snap Current control, R174, but at a cost of slowing the rate of rise of the fast Pulse Output signal.) The recommended setting of R174 is about 30° from the counterclockwise stop, and at a position where the displayed pulse time jitter is the least. Adjusting R174 for least trigger jitter (near its counterclockwise end) usually speeds the fast Pulse Output so the pulse risetime is about 45 or 50 ps.)

c. Once a pulse display is obtained, position it and the digital unit 0% and 100% zones as shown in Fig. 5-7. Read the risetime from the digital unit. With the Type 3T2 Time Magnifier at $\times 50$ for 200 ps sweep rate, 350 ps will be read as $+0.350\ \text{NS}$.

If the risetime of the sampling head is too slow, perform Step 5.

CRT Measurement of Risetime

Set the Type 3T2 controls:

Internal Samples/Div	Variable
Front Panel Samples/Div	9 o'clock
Start Point	Before Trigger
Trig Sensitivity	Clockwise to free run until a trace appears (several seconds), then back to 10 o'clock area for least trigger jitter.

The risetime can be measured at 200 ps/div sweep rate with the Type 3T2 Range and Time Magnifier controls set in the digital readout step. Use the Type 3S2 Units/Div Variable control to obtain an 8 division vertical display.

Most accurate risetime measurement from the CRT is made by taking a photograph. Scribe the photo in a manner similar to that done in Fig. 5-7B.

d. Check that the risetime is not more than 350 ps. If the risetime is slower than 350 ps, perform step 5.

NOTE

The remainder of this step checks the risetime of the two attenuators. Checking their risetime requires a pulser and signal delay coaxial cable that includes significant cable losses. Fig. 5-11, part B shows the losses in which the pulse appears to dribble up after the fast step portion is completed. Use only the fast step portion when checking attenuator risetime, ignoring the dribble up portions of the display. Fig. 5-11B shows the 100% point for Step 4 part (g) and (k) below.

e. $10\times$ attenuator test equipment setup is shown in Fig. 5-5B. Connections are as follows:

(1) Install the $50\ \Omega$ termination onto the Type 109 Charge Line 1 connector, connect the charge line (item 19 of equipment required) to the Type 109 Charge Line 2 connector and the Output connector to a CT-3 Signal Pickoff.

(2) Connect a 20 cm airline from the CT-3 to the input of a Type 113 Delay Cable and connect 20 ns of RG213/U coaxial cable to the Type 113 Output.

(3) Connect a $10\times$ BNC attenuator to the CT-3 and a BNC coaxial cable from the attenuator to the sampling sweep Trigger Input ($50\ \Omega$) connector.

(4) Connect a VP-2 voltage pickoff with a GR874—W50B $50\ \Omega$ termination to the delay cable output.

(5) Attach the $10\times$ attenuator to the Type S-3 probe and connect the $10\times$ attenuator to the VP-2 voltage pickoff. Obtain a display.

Performance Check/Calibration—Type S-3

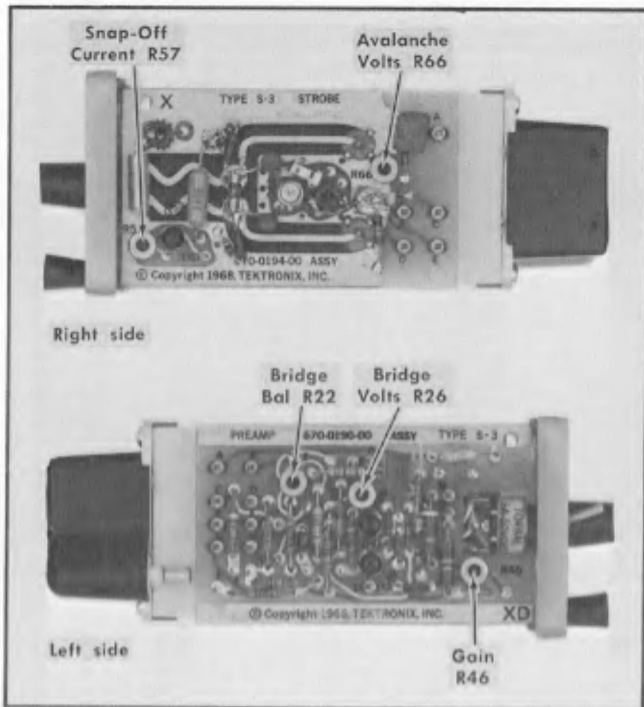

Fig. 5-8. Sampling head internal controls.

f. Set the sampling unit Units/Div switch to 100 and adjust the Variable control for a display amplitude of 8 divisions, along the fast rise portion.

g. Check that the 10% to 90% risetime is 400 ps or less.

h. Remove the 10 \times attenuator head and attach the 100 \times attenuator head. Use the equipment setup as shown in Fig. 5-5B with connections as given in step e (1) through (4) and connect the 100 \times attenuator to the VP-2 voltage pickoff.

i. Set the Type 109 Voltage Range switch to 50, and the Amplitude control fully clockwise (maximum).

j. Set the sampling unit Units/Div Variable control for an 8 division display amplitude and horizontally center the rising portion of the display with the sampling sweep unit Time Position control.

k. Check that the 10% to 90% risetime is 500 ps or less.

CAUTION

Be certain the outputs of the Type 109 and Type 106 are set to minimum before changing the attenuator heads, or changing to probe only operation.

5. Adjust Risetime

a. Each internal control has its particular effect upon sampling head operation.

(1) Avalanche Volts, R66, alters strobe pulse amplitude and risetime, which affects the display risetime and loop gain. Clockwise rotation makes risetime slower.

(2) Snap-Off Current, R57, alters loop gain, strobe amplitude and display noise, and must be slightly readjusted any time the Avalanche Volts control setting is changed.

(3) Gain, R46, alters loop gain by changing the Preampfier gain.

(4) Bridge Volts, R26, sets the reverse voltage of the sampling diodes. Decreasing the bridge volts (counterclockwise rotation) slows the displayed risetime by permitting a longer diode conduction time due to fixed amplitude strobe pulses. Keeping the Bridge Volts control near maximum (clockwise) allows better sampling loop gain linearity as well as a larger input signal dynamic range.

(5) Bridge Bal, R22, introduces an internal offset voltage to the feedback loop to cancel normal error signals in the sampling loop, including normal unbalance in the sampling bridge. R22 is adjusted (with DC Offset at zero) to cancel most of the trace vertical shift as the Units/Div switch position is changed.

NOTE

It is usually possible to achieve a risetime value less than that quoted in Section 1. The faster risetime is possible while also meeting the other specifications of noise and pulse flatness deviation. A simple CRT measurement of risetime is usually adequate to check for proper sampling operation. An exact figure of the system (pulser, coaxial cable, and sampling head system) risetime can be more easily obtained by use of a digital readout unit. The digital readout figure can be accepted as the risetime of the Type S-3 itself if the pulser used is as fast as the Type 284. The procedure below is not specifically limited to use with either form of risetime measurement; therefore, if you use a digital system, set the digital unit controls as listed in Step 4. Risetime adjustment is given as the first calibration step, because any time the Avalanche Volts control setting is changed, it is necessary to also adjust R57, R46 and R22 in that order.

b. Remove the sampling head cover. The head must be on an extender cable for access to all controls. Make the connections shown in Fig. 5-5A. Set the controls as in Step 4. Preset the sampling head internal controls (see Fig. 5-8):

Bridge Volts	Fully Clockwise
Gain	40° from clockwise end

Leave the other head controls as adjusted.

c. Operate the Type 3T2 with the Start Point switch at With Trigger. Obtain a display of the pulse rise.

Assuming that the risetime is slow, adjust the Avalanche Volts control about 5° counterclockwise.

Check the risetime and do (d) below. Then continue to adjust the Avalanche Volts control until the risetime is 350 ps or less, 10% to 90%. Repeat (d) again.

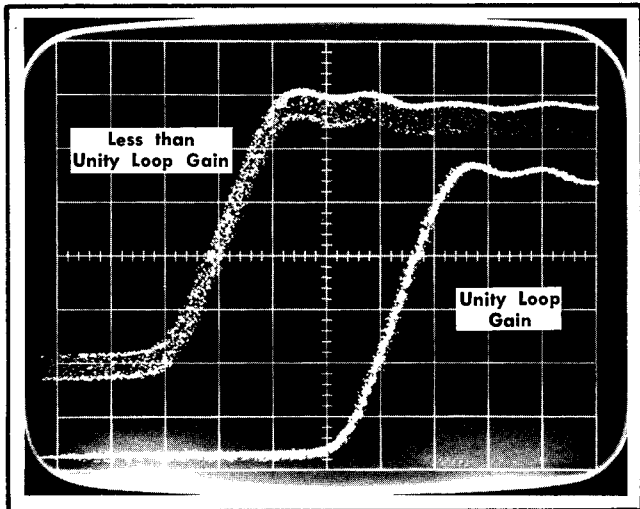

Fig. 5-9. Loop gain check in random sampling, before Trigger operation of the Type 3T2.

d. Operate the Type 3T2 with the Start Point switch at Before Trigger. Obtain a display of the pulse rise.

Adjust the Snap-Off Current control to minimize loop gain. This is done by first using the Type 3S2 Dot Response control to determine whether the display loop gain is more than or less than unity. If it is less than unity, adjust the Snap-Off Current control to reduce the trace vertical spread. If the loop gain is more than unity, adjust the Snap-Off Current control to increase the trace vertical spread. (See Fig. 5-9).

NOTE

The Type S-3 will in some cases have less display noise when adjusted for a risetime faster than 350 ps. The practical adjustment limit lies with the range of both the Snap-Off Current and the Gain controls. If the Avalanche Volts controls is adjusted for too fast a risetime, one or both of the other controls will reach the end of its adjustment range and prevent proper calibration.

As the Snap-Off Current control is turned, the display will move. The display shift is in the form of a rising or a dipping arc. The vertical component of the display movement is a result of a change in Snap-Off Current, rather than any signal input change. The peak of the arc in either the positive or the negative direction occurs very near the point at which maximum loop gain occurs. Set the Snap-Off Current control to the point where the display is at the peak of the arc, rather than precisely at maximum loop gain. This produces minimum display noise with proper risetime.

e. Set the Type 3S2 Dot Response control to its electrical midpoint. The electrical midpoint is found by watching the change in trace spread through the total range of adjustment of the control. Set the control for a trace spread halfway between maximum loop gain and minimum loop gain.

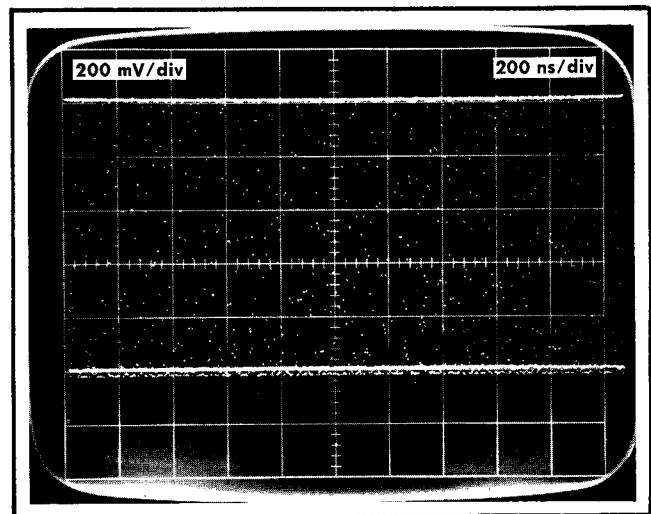

Fig. 5-10. Unity loop gain set at top of display.

Now adjust the Type S-3 Gain control for unity loop gain as indicated at the right of Fig. 5-9A.

6. Check Loop Gain Linearity

Requirement—Dot will move full amplitude $\pm 5\%$ of any signal up to 1 V peak to peak (valuable with random process sampling); signal to $10\times$ attenuator, 10 V peak to peak; signal to $100\times$ attenuator, 100 V peak to peak.

NOTE

Correct adjustment of the Bridge Balance control (not more than 1 division trace movement with rotation of the Units/Div switch from 200 to 20) and the sampling unit Smoothing Balance, R247/R457 in the Type 3S2 (no trace movement as the Normal-Smooth switch is changed from Normal to Smooth) is necessary for correct operation.

The connections between the Type 284 and the sampling head are changed in this step. The head can be either on the extender cable with or without the case installed, or it can be in the Type 3S2 with the case in place.

a. Connect the Type 284 Square Wave Output connector to the sampling head probe through a VP-2 voltage pickoff with $50\ \Omega$ termination attached.

b. Set the Type 284 Period switch to $1\ \mu\text{s}$. Set the Type 3T2 Range switch to $10\ \mu\text{s}$, the Time Magnifier to $\times 5$ (200 ns/div) and the Start Point switch to With Trigger.

c. Set the Type 3S2 Units/Div switch to 20 and obtain a triggered square wave display. Use the Type 3S2 Variable Units/Div control to obtain 5 divisions of amplitude.

d. Disconnect the trigger signal. Turn the sampling sweep Trigger Sensitivity and Recovery Time controls for a free run display as in Fig. 5-10.

Performance Check/Calibration—Type S-3

e. Set the sampling unit Dot Response control so the top of the square wave is at unity loop gain (one trace). The bottom of the square wave can show two traces, the separation (loop gain overshoot or undershoot) must not be greater than 5%, or 1.25 minor divisions.

7. Preliminary Bridge Bal Adjust

a. Free run the sampling sweep to obtain a no-signal trace.

b. Set the Type 3S2 Offset control for zero volts at the front panel Offset jack. Use either the test oscilloscope or a bench multimeter to determine zero volts.

c. As the Type 3S2 Units/Div switch as operated from 200 to 20, adjust the sampling head Bridge Bal control (R22) for no more than one division of vertical shift in the trace. (This control adjustment varies with the case on or off the sampling head, and varies with changes in extender cable. Movement of the probe cable can also cause the trace to shift position.)

8. Check Pulse Flatness Deviation

Requirement—Probe only; Pulse will not deviate from flat more than +8% to -2% (total 10%) for first 2 ns after step, nor more than +1% to -1% (total 2%) thereafter.

10× attenuator: Pulse will not deviate from flat more than +2% to -5% (total 7%) for first 5 ns after step, nor more than +1% to -1% (total 2%) thereafter.

100× attenuator: Pulse will not deviate from flat more than +5% to -8% (total 13%) for first 5 ns after step, +2% to -5% (total 7%) from 5 ns to 30 ns after step, +1% to -1% (total 2%) thereafter.

NOTE

Some minor aberrations are due to the Type 284. The requirement limits include deviations that are part of the Type 284. Therefore, the limits apply only when testing with the Type 284, and with a 20 cm air line between the pulser and the VP-2 and probe.

a. Use the equipment setup shown in Fig. 5-5A. The connections are as follows:

(1) Connect a BNC coaxial cable from the Type 284 Trigger Out to the sampling sweep unit Trigger Input (50 Ω).

(2) Connect the Type 284 Pulse Output to the 20 cm air line, the VP-2 voltage pickoff, then the GR874-W50B 50 Ω termination. Connect the Type S-3 probe to the VP-2.

b. Set the sampling sweep unit Range switch to 100 ns and the Time Magnifier switch to ×10 (1 ns/div).

c. Set the sampling unit Units/Div switch to 100 and adjust the Variable control for 5 divisions from the baseline to the flat top of the display.

d. Set the sampling unit Units/Div switch to 10 without disturbing the Variable control, and center the top of the display with the DC Offset control; see Fig. 5-11.

e. Check that the pulse flatness deviation during the first 2 ns (2 divisions) does not exceed +8% (each vertical division represents 2% of the total display height) nor -2% for a total of 10% (Fig. 5-11A).

f. Change the sampling sweep unit Time Magnifier to ×2 (5 ns/div) and check the pulse flatness deviation following the first 2 ns through 20 ns, for not more than +1% nor -1% for a total of 2%. (2 ns through 10 ns, see Fig. 5-11A. 10 ns through 1.8 μs, see Fig. 5-11E; equipment set-up described in part t below.)

NOTE

The portions of this step that check attenuator pulse flatness deviation need not be performed unless there is a question about an individual attenuator. If one has been dropped, or electrically damaged, a check of its pulse flatness characteristics can reveal if it needs replacement. There is no adjustment in either attenuator to compensate for an out of tolerance pulse flatness deviation.

The double exposure pictures of Fig. 5-11 are provided to show a comparison of the pulse flatness deviation characteristics of the probe and of the 10× attenuator with the same generator source. Pulse flatness deviations of the attenuator are seen as changes in separation between the "Probe/Gr-10×" waveform and the "10× Attenuator" waveform. One of the two numbered points is at minimum separation, and the other numbered point is at the maximum separation (points 1 and 2 in Fig. 5-11C through F). This method requires either a camera for double exposures, or a storage oscilloscope in order to make valid comparisons.

Attenuators

g. Set the sampling unit Units/Div switch to 100 and the Variable to CAL.

h. Initial equipment setup.

(1) Place the 50 Ω termination onto the Type 109 Charge Line 1 connector, the charge line (item 19) to the Charge Line 2 connector and a CT-3 Signal Pickoff onto the Output connector.

(2) Connect a 20 cm air line from the CT-3 to the input of a Type 113 Delay Cable, with 20 ns of RG213/U coaxial cable added to the output of the Type 113.

(3) Connect a 10× BNC attenuator to the CT-3 trigger pickoff output connector and a BNC coaxial cable from the attenuator to the sampling sweep unit Trigger Input (50 Ω) connector.

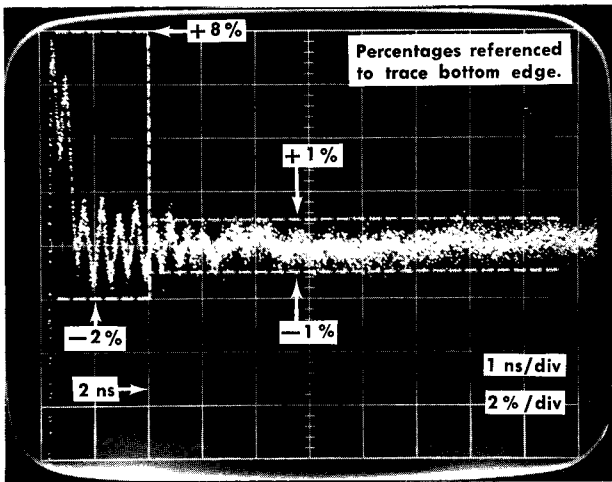

(A) Type 284, pulse—Type S-3 Probe.

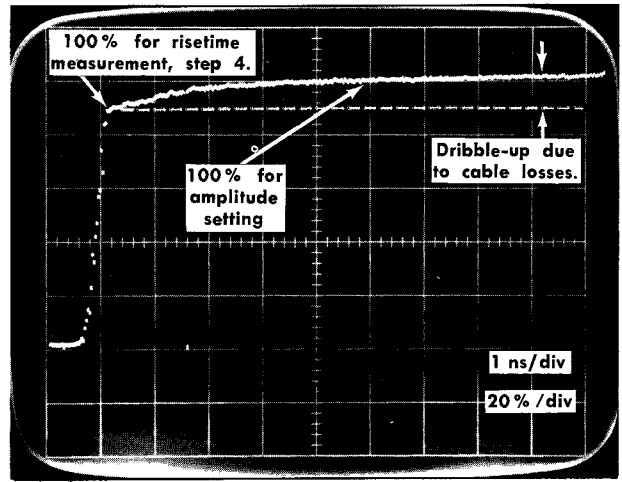

(B) Type 109—10× attenuator attached.

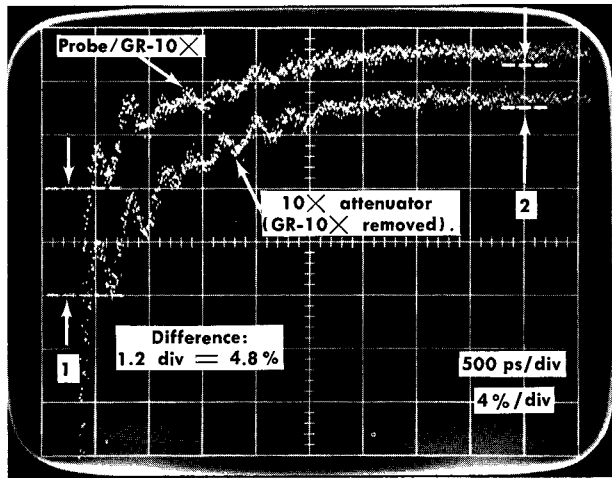

(C) Type 109.

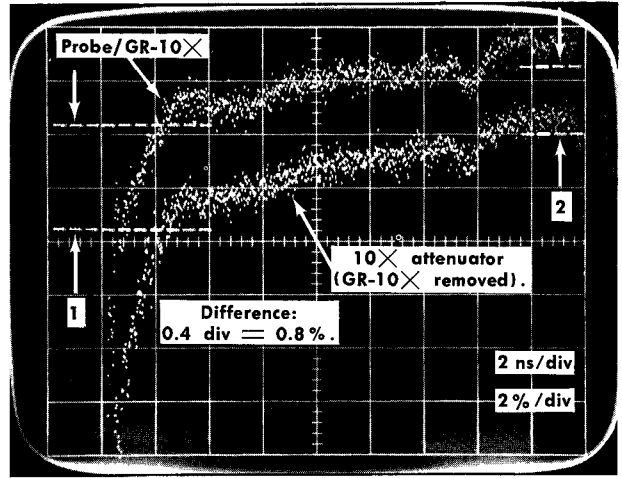

(D) Type 109.

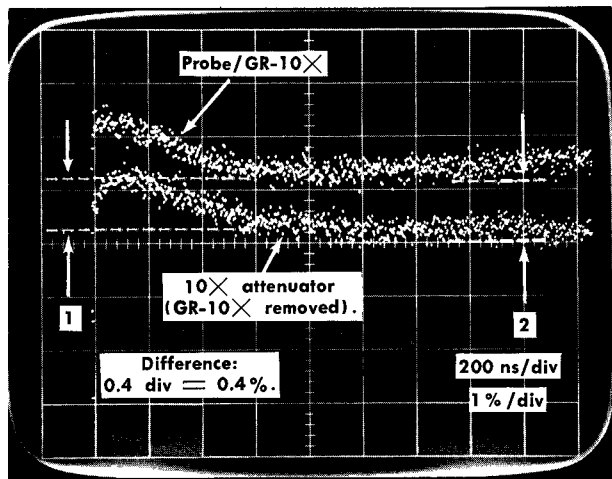

(E) Long term, using Type 106.

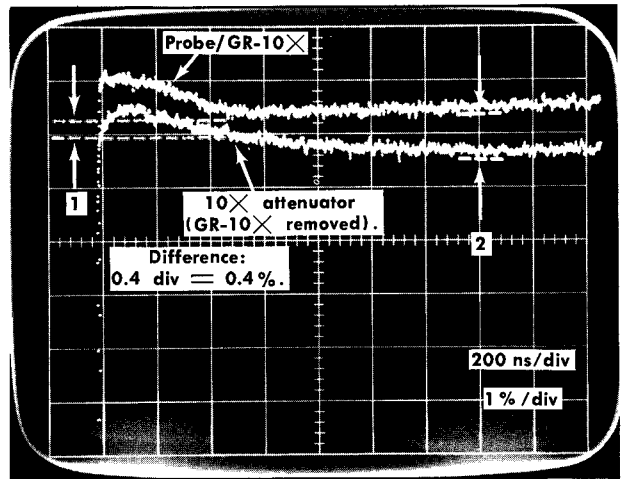

(F) Type 106, smoothed display.

Fig. 5-11. Pulse flatness deviation, step 8.

Performance Check/Calibration—Type S-3

(4) Connect a GR-10 \times attenuator to the delay cable output and a VP-2 voltage pickoff with a GR874-W50B 50 Ω termination to the GR-10 \times attenuator.

(5) Connect the probe tip into the VP-2 voltage pickoff.

i. Set the Type 109 Voltage Range switch to 5 and the Amplitude control fully clockwise. Adjust the sampling unit Variable Units/Div control for a 5 division display.

j. Set the sampling sweep unit for a 1 ns/div sweep rate (Range switch to 100 ns and the Time Magnifier switch to $\times 10$).

k. Refer to Fig. 5-11C. Change the Type 3S2 Units/Div switch to 10 and use the DC Offset control to vertically place the pulse at a reference on the graticule and the sampling sweep unit Time Position controls for horizontal placement. (This display must be retained for reference either by storage on a storage oscilloscope, or by photograph which is not developed until a second waveform is also exposed. Remember the location on the graticule.) Fig. 5-11C and D are examples of the two exposures and desired measurement of the separation. The percentage per vertical division is dependent on the Units/Div switch setting, a 5 division display at 100 Units/Div is 20%/div and will be 4%/div at 20 Unit/Div or 2%/div at 10 Units/Div. (This completes obtaining the "Probe/GR-10 \times " waveform.)

l. Checking a 10 \times probe attenuator. Remove the probe and install the 10 \times attenuator onto its tip. Remove the GR-10 \times attenuator at the delay cable output and VP-2. Connect the VP-2 to the delay cable output and the 10 \times attenuator to VP-2. Do not change the generator output amplitude. This setup is shown in Fig. 5-5B.

m. Place the display near the stored "Probe/Gr-10 \times " display, using only the DC Offset and Time Position controls. Expose the waveform and develop the photograph. Determine the separation difference(s) between the two waveforms. This is the percentage of pulse flatness deviation for the 10 \times attenuator, and should not exceed a total of 7% in the first 5 ns of the pulse.

n. Checking a 100 \times probe attenuator. Remove the 10 \times attenuator from the probe. Install 2 GR-10 \times attenuators between the delay cable output and the VP-2.

o. Connect the probe to the VP-2. Set the Type 109 Voltage Range switch to 50.

p. Set the sampling unit Units/Div switch to 100 and adjust the Variable control for 5 divisions of display amplitude. Leave the sampling sweep unit sweep rate at 1 ns/div.

q. Set the sampling unit Units/Div switch to 10 and position the waveform as in part k for storage or photograph.

r. Install the 100 \times attenuator to the probe tip. Remove both GR-10 \times attenuators between the delay cable and the VP-2. Connect the VP-2 to the delay cable output and the 100 \times attenuator into the VP-2.

s. Position the display near the stored "Probe/2 GR-10 \times " display as in part m for comparison with the stored display or the second exposure. Determine the separation differ-

ence(s) between the waveforms. For the 100 \times attenuator, the difference should not exceed a total of 13% during the first 5 ns of the pulse, nor more than a total of 7% during the 5 ns through 20 ns time interval, which is checked at 5 ns/div (Time Magnifier switch at $\times 2$).

t. Long-term pulse flatness deviations are checked as follows for the probe, 10 \times attenuator and 100 \times attenuator:

(1) Connect a GR-10 \times attenuator and the VP-2 voltage pickoff with the 50 Ω termination GR874-W50B attached to the Type 106 Hi Amplitude Output.

(2) Connect a BNC coaxial cable from the Trigger Output to the sampling sweep unit 50 Ω Trigger Input.

(3) Set the sampling sweep unit for a 200 ns/div sweep rate (Range switch to 100 μ s and Time Magnifier to $\times 50$).

u. Set the sampling unit Units/Div switch to 100 and connect the Type S-3 probe only to the VP-2.

v. Set the Type 106 Repetition Rate at 50 kHz and obtain a stable display. Set the Type 106 Amplitude control for a 5 division display and position the top portion of the pulse into the graticule area.

w. Set the sampling unit Units/Div switch to 5 and check that the pulse flatness deviations are not more than +1% or -1% (total 2%) with each vertical division representing 1% of the display height following the first 2 ns.

x. To check the 10 \times attenuator, the displayed waveform of the pulse in part w must be stored or photographed as before.

y. Remove the probe and install the 10 \times attenuator. Remove the GR-10 \times attenuator and connect the VP-2 to the Type 106 Output connector. Install the probe 10 \times attenuator in the VP-2.

z. Position the display and compare it to the stored display, note the separation at 2 points, determine the difference and check that the percentage is not greater than a total of 2% following the first 5 ns.

aa. Remove the 10 \times attenuator from the VP-2. Install two GR-10 \times attenuators between the Type 106 Output and the VP-2.

Set the Type 106 Amplitude control fully clockwise.

ab. Connect the probe to the VP-2. Set the sampling unit Units/Div switch to 50 and adjust the Variable control for a 5 division display amplitude. Set the Units/Div switch to 5 and store the display as before.

ac. Remove the two GR-10 \times attenuators, connect the VP-2 to the Output connector and attach the 100 \times attenuator to the probe and to the VP-2.

ad. Compare the display with the stored waveform as in part z. Check that the pulse flatness deviations are not more than a total of 7% from 20 ns to 30 ns and not more than a total of 2% following the first 30 ns.

Set the Type 106 Amplitude control fully counterclockwise.

9. Final Bridge Bal Adjust

a. Place the case on the sampling head, securing the four mounting bolts at the rear.

Fig. 5-12 shows the correct orientation of the sampling head case when re-installing it. Note that the Preamplifier and Strobe Generator boards slide between part of the case and the zig-zag springs that run from the front to the back. Correct case orientation places the one hole in the case over the Bridge Bal control. In sliding the case on, the white plastic locking latch must be fitted into part of the casting.

The rear casting is mounted so the hole in the casting is at the bottom. Place the rear casting in place before inserting the four long mounting bolts. Fit the rear casting and case in place by hand so there is no space between either end casting and the case before tightening the bolts.

b. Place the head either inside the Type 3S2 Channel A compartment, or upon the extender cable with which it is normally used. If the head is not normally used on an extender cable, adjust the Bridge Bal control with the head inside the Type 3S2.

c. Free run the sampling sweep unit with a 50 ns sweep rate (3T4 or 3T77A, use $.5 \mu\text{s}/\text{div}$). Set the Channel A DC Offset control for zero volts at the front panel Offset connector. Center the trace with the Position control.

d. Operate the Type 3S2 Units/Div switch from 200 to 20 and adjust the Bridge Bal control (through the hole in the left side of the case) for not more than one division of vertical shift.

10. Check Tangential Display Noise

NOTE

When making a visual noise reading from a sampling display, the eye interprets a noise value which is neither the RMS nor the peak to peak value. Since most observers agree that the displayed noise value is approximately 3 times the RMS value, the Tangential Noise here defined is 3 times the RMS value. (The measurement technique given produces acceptable agreement between various operators as to the instrument's noise value.)

Requirement—Tangential noise will be not greater than 3 mV, with the case on the sampling head; $10\times$ attenuator

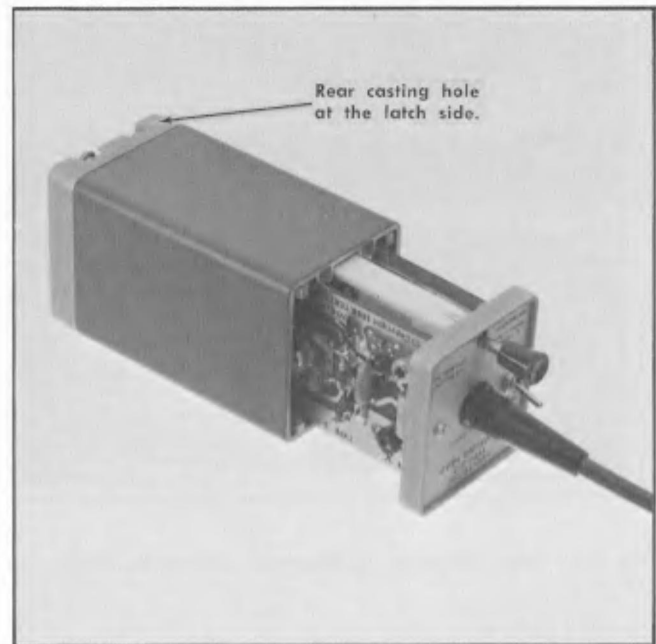

Fig. 5-12. Correct board and latch positions when re-installing the Sampling Head case.

tangential noise will not be greater than 30 mV; $100\times$ attenuator tangential noise will not be greater than 300 mV.

NOTE

System noise does not change with the addition of an attenuator to the probe tip. The noise values stated in the requirement above are referred to the input and the $\times 10$ and $\times 100$ change in attenuator tip input deflection factor. It is therefore not necessary to check the noise with an attenuator attached to the probe tip.

a. Install a GR $5\times 50 \Omega$ attenuator on the Type 284 Square Wave Output connector. Install the special variable attenuator (item 12) onto the $5\times$ attenuator. Connect the VP-2 voltage pickoff (with 50Ω termination attached) between the variable attenuator and the tip. (The sampling head can be either inside the Type 3S2, or on an extender cable. The case must be in place on the head.)

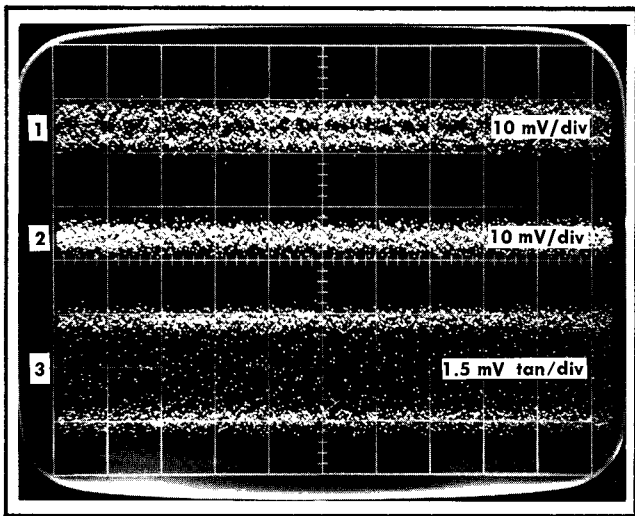

Fig. 5-13. Triple exposures of Tangential noise measurement, step 10.

b. Set the Type 284 controls:

Period	1 μ s
Square Wave Amplitude	100 mV
Lead Time	Optional

c. Set the sampling unit Units/Div switch to 10.

d. Set the sampling sweep unit controls:

Trig Sensitivity	Clockwise - free run
Sweep rate	1 μ s/div

Remove any external cable from the sampling sweep unit external trigger input connector.

e. Refer to Fig. 5-13 during the following noise measurement procedure.

(1) Obtain a display of two traces as shown at point (1) of Fig. 5-13. Adjust the variable attenuator until the two traces blend together just to the point (2) at which they appear as one trace.

(2) Set the Type 284 Square Wave Amplitude control to 1.0V ($\times 10$ signal amplitude). The display (3) now has a tangential deflection factor of 1.5 mV/div. ($E_{\text{tangential}}$ per division is equal to the Type 3S2 Units/Div setting of 10 mV divided by 2, times 3 divided by 10 = 1.5 mV/div.) Therefore, the 3 mV tangential noise limit includes 2 graticule divisions (3) of Fig. 5-13. Check that the bottom edges of the two traces are not more than 2 divisions apart. Waveform (3) Fig. 5-13 measures as 3 mV tangential noise.

Determining Tangential Noise Deflection Factor

The noise display (3 of Fig. 5-13) has a noise deflection factor based upon the signal amplitude, the Type 3S2 Units/Div switch setting, the fact that the final trace separation is twice the RMS noise, and that the tangential noise is then 3 times the RMS noise. The square wave signal amplitude that makes two traces appear as one sets the trace separation to twice the RMS noise. The procedure used here then

permits a noise deflection factor to be determined by dividing the input mV/div deflection factor by 2 (trace separation is $2 \times$ the RMS noise), multiplying by 3 (tangential noise is $3 \times$ the RMS noise) and then dividing by 10 (the signal amplitude change complement).

f. If the tangential noise is outside the required limits, return to Step 5. Choose an Avalanche Volts setting that produces minimum noise right after the pulse rise (in With Trigger sweep mode). If it is impossible to obtain a sufficiently low noise figure, replace Q69 and repeat the rest of the procedure again.

11. Check Offset Accuracy

Requirement—Accuracy with probe only is $\pm 1.6\%$ at $\times 1$ offset, or $\pm 1.35\%$, at $\times 2$ offset.

100 \times attenuator accuracy is $\pm 3.1\%$ at $\times 1$ offset, or $\pm 2.85\%$ at $\times 2$ offset.

1000 \times attenuator accuracy is $\pm 3.85\%$ at $\times 1$ offset, or $\pm 3.6\%$ at $\times 2$ offset.

NOTE

The offset accuracy of the sampling unit must be known. This step, as a preliminary method, uses a Type S-1 as a standard for checking the offset accuracy of the sampling unit.

a. Set the sampling sweep unit for 2 μ s/div (Range switch to 100 μ s and Time Magnifier switch to $\times 5$).

b. Set the sampling unit Units/Div switch to 100.

c. Set the 50 Ω Amplitude Calibrator Volts switch to .6 and the Test-Operate switch to Operate.

d. Install the Type S-1 in the sampling unit and connect the 50 Ω Amplitude Calibrator Output to the Type S-1 input through a 5 ns coaxial cable. Connect a BNC coaxial cable from the Trigger Output connector to the sampling sweep unit Trigger Input 50 Ω connector.

e. Connect the 1 \times probe from the Type W (test oscilloscope) to the Offset Out jack on the sampling unit. (Type 3S6: TP663 CH A TP763 CH B, of Offset circuit card.) Set the Type W controls as follows:

Vc Range	+11
Comparison Voltage	000
Display	A—Vc
Input Atten	R = ∞

f. Position the indicator oscilloscope display bottom to the graticule centerline using the DC Offset control. Use the Test oscilloscope (Type W) and measure the sampling unit DC Offset voltage (Type 3S2 and 3S5 measured at the front panel Offset jack; Type 3S6 measured at TP 663 CH A, or TP763 CH B, of the Offset circuit card, with a center card extender and rigid plug-in extender in use). The voltage will be at or very near zero.

Change the sampling unit Units/Div switch to 50 and reset the display bottom of the graticule centerline with the DC Offset control. Now measure and record the DC Offset voltage with the test oscilloscope.

g. Set the Type W Comparison Voltage outer dial to 6, so the comparison voltage is now 6.00 volts different from the measurement in part f.

With the sampling unit DC Offset control, position the display downward so the top is at the graticule centerline. Make certain that the displayed square wave line is in the exact relationship to the centerline as when positioning the display bottom in part f.

Measure the DC Offset voltage with the test oscilloscope, using the same test oscilloscope graticule line used in part f.

The accuracy of the sampling unit is the difference of offset measurements and correct voltage expressed as a percentage of the total. Note the sampling unit offset accuracy.

h. Install the Type S-3 in the Channel A compartment and allow 5 minutes warm-up. Connect the VP-2 and tested 50 Ω termination to the Amplitude calibrator. Install the S-3 probe into the VP-2.

i. Measure the Offset voltage as parts f and g. Check that the difference between the Type S-3—sampling unit accuracy and the Type S-1—sampling unit accuracy, which is the Type S-3 offset error, is within the tolerance listed in the requirement.

Repeat the above procedure of parts g and h. The total difference between the two Comparison Voltage readings must be between 5820 (5.820 V) and 6180 (6.180 V), which includes the following tolerances: probe, $\pm 0.5\%$ at $\times 2$ OFFSET; termination, $\pm 0.5\%$; and sampling unit, $\pm 2\%$.

12. Check Deflection Factor Accuracy

NOTE

Deflection factor accuracy of the sampling unit must be known. This step, as a preliminary method, uses a Type S-1 Sampling Head as a standard for checking or setting the output of the sampling unit. No other method is acceptable.

a. Measure the input resistance of the Type S-1 Sampling Head with a resistance bridge and note any variation from 50 Ω .

b. Install the Type S-1 in the sampling unit and connect the 50 Ω Amplitude Calibrator Output to the Type S-1 input through a 5 ns coaxial cable. Set the 50 Ω Amplitude Calibrator Volts switch for 0.6 volts.

c. Set the Type 3S2 Sampling Unit Units/Div switch to 100 and the sampling sweep for 2 $\mu\text{s}/\text{div}$ (Range switch to 100 μs and Time Magnifier switch to $\times 5$). Obtain a stable 6 division display and position it at the center of the graticule area.

d. Set the Type W controls as follows:

Millivolts/cm	10
Variable	Cal
Input Atten	10
Display	A-Vc
Input Coupling	DC

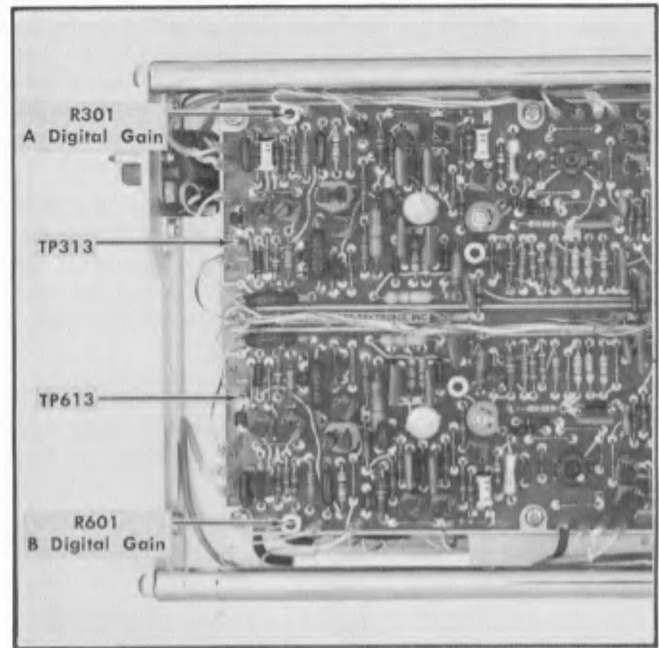

Fig. 5-14. Locations of Digital Outputs in the Type 3S2.

e. Connect the $1\times$ probe from the Type W A Input to the sampling unit Digital Output. In the Type 3S2, connect to TP313 for Channel A operation or TP613 for Channel B operation (Pin 1 or Pin 3 on the vertically mounted interconnecting plug). See Fig. 5-14 for locations. (Type 3S5 or 3S6, TP 418 CH A, or TP 438 CH B, located on the Output board.)

f. This step describes how to eliminate the contribution to deflection factor accuracy of the vertical channel of the sampling system. An adjustment is made within the sampling unit that removes any error of the measurement that might otherwise come from the signal source, the sampling feedback loop, the Type S-1 input resistance and the Type W signal voltage measurements. The only remaining system error is due to the accuracy (error) of the 50 Ω GR874W-50B termination used with the VP-2 and S-3 probe. It must also be measured.

The signal measured by the Type W and test oscilloscope is the output of the Channel Amplifier. That 6 V peak to peak signal must have its peak to peak limits between 0 V and +20 V. Set the Channel Amplifier output signal within that range with the sampling unit DC Offset control. Make the measurement as follows:

Set the Type W Vc Range switch to +11 and the Comparison Voltage outer dial to 1. Set the test oscilloscope square wave display bottom to the graticule centerline using the Type W Position control, the sampling unit DC Offset control, and the Comparison Voltage inner dial. (The outer dial may have to be a 0.) Record the dial reading, and do not disturb the Type W Position control or the sampling unit DC Offset control.

Increase the Type W Comparison Voltage dial readings until the test oscilloscope display top is at the graticule centerline. Record the dial readings. The difference between the two sets of dial readings must equal 6.00 volts if

Performance Check/Calibration—Type S-3

the Type S-1 input resistance is exactly $50\ \Omega$. If the input resistance is 0.5% high, the input voltage will actually be 0.25% high. Adjust the sampling unit internal Digital Gain control so the Channel Amplifier output is 0.25% more than 6.00 volts, or to 6.015 volts peak to peak. If the Type S-1 input resistance is low, adjust the Digital Gain for a lower amplitude output signal.

g. Measure and record the DC resistance of the $50\ \Omega$ termination to be used with the VP-2 and the S-3 probe. Remove the Type S-1 from the sampling unit. Install the Type S-3 and allow 5 minutes warm-up. Connect the VP-2 and tested $50\ \Omega$ termination to the Amplitude Calibrator. Install the S-3 probe into the VP-2.

h. Measure the Channel Amplifier output voltage with the Type W Comparison Voltage as in part f. Check that the signal voltage is 6 V peak to peak $\pm 30\ \text{mV}$, $\pm 0.5\%$,

plus the error caused by the GR874-W50B termination.

i. Install the $10\times$ attenuator on the Type S-3 probe and set the $50\ \Omega$ Amplitude Calibrator for 2 volts. Center the 2 division display.

j. Measure the Channel Amplifier output voltage as before in part f. Check that the signal voltage is 2 V peak to peak, $\pm 35\ \text{mV}$, $\pm 1.75\%$, plus the error caused by the GR874-W50B termination.

k. Remove the $10\times$ attenuator. Install the $100\times$ attenuator on the Type S-3 probe. Set the sampling unit Units/Div switch to 10 and center the 2 division display.

l. Measure the Channel Amplifier output voltage as in part f. Check that the signal voltage is 2 V peak to peak, $\pm 50\ \text{mV}$, $\pm 2.5\%$, plus the error caused by the GR874-W50B termination.

PARTS LIST ABBREVIATIONS

BHB	binding head brass	int	internal
BHS	binding head steel	lg	length or long
cap.	capacitor	met.	metal
cer	ceramic	mtg hdw	mounting hardware
comp	composition	OD	outside diameter
conn	connector	OHB	oval head brass
CRT	cathode-ray tube	OHS	oval head steel
csk	countersunk	PHB	pan head brass
DE	double end	PHS	pan head steel
dia	diameter	plstc	plastic
div	division	PMC	paper, metal cased
elect.	electrolytic	poly	polystyrene
EMC	electrolytic, metal cased	prec	precision
EMT	electrolytic, metal tubular	PT	paper, tubular
ext	external	PTM	paper or plastic, tubular, molded
F & I	focus and intensity	RHB	round head brass
FHB	flat head brass	RHS	round head steel
FHS	flat head steel	SE	single end
Fil HB	fillister head brass	SN or S/N	serial number
Fil HS	fillister head steel	SW	switch
h	height or high	TC	temperature compensated
hex.	hexagonal	THB	truss head brass
HHB	hex head brass	thk	thick
HHS	hex head steel	THS	truss head steel
HSB	hex socket brass	tub.	tubular
HSS	hex socket steel	var	variable
ID	inside diameter	w	wide or width
incd	incandescent	WW	wire-wound



PARTS ORDERING INFORMATION

Replacement parts are available from or through your local Tektronix, Inc. Field Office or representative.

Changes to Tektronix instruments are sometimes made to accommodate improved components as they become available, and to give you the benefit of the latest circuit improvements developed in our engineering department. It is therefore important, when ordering parts, to include the following information in your order: Part number, instrument type or number, serial or model number, and modification number if applicable.

If a part you have ordered has been replaced with a new or improved part, your local Tektronix, Inc. Field Office or representative will contact you concerning any change in part number.

SPECIAL NOTES AND SYMBOLS

- | | |
|---|---|
| ×000 | Part first added at this serial number |
| 00× | Part removed after this serial number |
| *000-0000-00 | Asterisk preceding Tektronix Part Number indicates manufactured by or for Tektronix, Inc., or reworked or checked components. |
| Use 000-0000-00 | Part number indicated is direct replacement. |
|  | Screwdriver adjustment. |
|  | Control, adjustment or connector. |

SECTION 6

ELECTRICAL PARTS LIST

Values are fixed unless marked Variable.

Ckt. No.	Tektronix Part No.	Serial/Model No. Eff	Disc	Description
----------	--------------------	----------------------	------	-------------

Capacitors

Tolerance $\pm 20\%$ unless otherwise indicated.

C1	- - - - -			(See Mech. Parts, Body-Tip Assembly)	
C11	283-0165-00		50 pF	Cer 1000 V	5%
C12	283-0165-00		50 pF	Cer 1000 V	5%
C21	283-0051-00		0.0033 μ F	Cer 100 V	5%
C23	283-0051-00		0.0033 μ F	Cer 100 V	5%
C30	281-0679-00		15 pF	Cer 50 V	10%
C34	283-0119-00		0.0022 μ F	Cer 200 V	10%
C38	283-0032-00		470 pF	Cer 500 V	5%
C40	283-0067-00		0.001 μ F	Cer 200 V	10%
C43	290-0246-00		3.3 μ F	Elect. 15 V	10%
C44	283-0005-00		0.01 μ F	Cer 250 V	
C45	283-0066-00		2.5 pF	Cer 200 V	
C46	283-0067-00		0.001 μ F	Cer 200 V	1%
C49	283-0005-00		0.01 μ F	Cer 250 V	
C51	283-0121-00		0.001 μ F	Cer 200 V	
C53	283-0121-00		0.001 μ F	Cer 200 V	
C55	290-0134-00		22 μ F	Elect. 15 V	
C59	*283-0072-01		0.01 μ F	Cer	
C63	283-0103-00		180 pF	Cer 500 V	5%
C64	283-0103-00		180 pF	Cer 500 V	5%
C65	283-0005-00		0.01 μ F	Cer 250 V	
C69	281-0612-00		5.6 pF	Cer 200 V	± 0.5 pF
C71	283-0121-00		0.001 μ F	Cer 200 V	
C80 ¹					
C81 ¹					
C84 ¹					
C90 ²					
C91 ²					
C94 ²					
C96 ²					

Semiconductor Device, Diodes

D4	152-0368-00	Silicon	Bridge
D11	*152-0322-00	Silicon	Tek Spec
D12	*152-0322-00	Silicon	Tek Spec
D41	*152-0185-00	Silicon	Replaceable by 1N4152
D61	*152-0335-00	Silicon	Snap-Off

¹Furnished as a unit with 10X Attenuator Head (010-0364-00)

²Furnished as a unit with 100X Attenuator Head (010-0365-00)

Electrical Parts List—Type S-3

Connectors

Ckt. No.	Tektronix Part No.	Serial/Model No. Eff	Disc	Description
J11	131-0265-00			Coaxial right-angle
J12	131-0265-00			Coaxial right-angle
J51	131-0582-00			Coaxial female
J53	131-0582-00			Coaxial female
P11	- - - - -			(See Mech. Parts, Probe & Cable Assembly)
P12	- - - - -			(See Mech. Parts, Probe & Cable Assembly)
P51	131-0391-00			Coaxial male
P53	131-0391-00			Coaxial male

Inductors

L40	276-0507-00			Core, ferramic suppressor
L55	*120-0382-00			Toroid 14 turns, single
L60	*108-0170-01			0.5 μ H
L62	*108-0170-01			0.5 μ H

Transistors

Q31	151-1023-00		Silicon	FET
Q41	151-0224-00		Silicon	2N3692
Q45	151-0224-00		Silicon	2N3692
Q55	151-0224-00		Silicon	2N3692
Q69	*153-0556-00		Silicon	Selected

Resistors

Resistors are fixed, composition, $\pm 10\%$ unless otherwise indicated.

R1	325-0033-00	50 k Ω	1/10 W	Prec	1/4 %
R3	307-0150-00	75 Ω	0.075 W		5%
R4	325-0033-00	50 k Ω	1/10 W	Prec	1/4 %
R5	325-0037-00	100 Ω	1/20 W	Prec	1%
R6	325-0037-00	100 Ω	1/20 W	Prec	1%
R7	325-0001-00	100 k Ω	1/20 W	Prec	1%
R8	325-0001-00	100 k Ω	1/20 W	Prec	1%
R11	317-0151-00	150 Ω	1/8 W		5%
R12	317-0151-00	150 Ω	1/8 W		5%
R13	317-0510-00	51 Ω	1/8 W		5%
R14	317-0510-00	51 Ω	1/8 W		5%
R16	317-0102-00	1 k Ω	1/8 W		5%
R17	317-0102-00	1 k Ω	1/8 W		5%
R20	321-0385-00	100 k Ω	1/8 W	Prec	1%
R21	321-0253-00	4.22 k Ω	1/8 W	Prec	1%
R22	311-0609-00	2 k Ω , Var	1/2 W		30%
R23	321-0253-00	4.22 k Ω	1/8 W	Prec	1%
R24	321-0385-00	100 k Ω	1/8 W	Prec	1%
R26	311-0613-00	100 k Ω , Var	1/2 W		30%
R27	321-0776-03	3.501 k Ω	1/8 W	Prec	1/4 %

Resistors (cont)

Ckt. No.	Tektronix Part No.	Serial/Model No. Eff	Disc	Description		
R28	321-0777-03		5.14 k Ω	1/8 W	Prec	1/4 %
R29	321-0778-03		5.148 k Ω	1/8 W	Prec	1/4 %
R30	307-0150-00	XB020000	75 Ω	0.075 W		5%
R31	301-0912-00		9.1 k Ω	1/2 W		5%
R32	317-0221-00		220 Ω	1/8 W		5%
R34	301-0123-00		12 k Ω	1/2 W		5%
R38	321-0779-03		7.02 k Ω	1/8 W	Prec	1/4 %
R39	321-0780-03		18.96 k Ω	1/8 W	Prec	1/4 %
R40	317-0224-00		220 k Ω	1/8 W		5%
R41	317-0223-00		22 k Ω	1/8 W		5%
R42	317-0122-00		1.2 k Ω	1/8 W		5%
R44	317-0101-00		100 Ω	1/8 W		5%
R45	317-0303-00		30 k Ω	1/8 W		5%
R46	311-0607-00		10 k Ω , Var	1/2 W		30%
R47	315-0242-00		2.4 k Ω	1/4 W		5%
R56	317-0271-00		270 Ω	1/8 W		5%
R57	311-0607-00		10 k Ω , Var	1/2 W		30%
R59	308-0243-00		240 Ω	3 W	WW	5%
R60	317-0390-00		39 Ω	1/8 W		5%
R62	317-0390-00		39 Ω	1/8 W		5%
R65	317-0101-00		100 Ω	1/8 W		
R66	311-0644-00		20 k Ω , Var	1/2 W		30%
R68	317-0332-00		3.3 k Ω	1/8 W		5%
R70	317-0332-00		3.3 k Ω	1/8 W		5%
R71	317-0202-00		2 k Ω	1/8 W		5%
R72	315-0203-00		20 k Ω	1/4 W		5%
R73	307-0124-00		5 k Ω	Thermal		
R80 ³						
R81 ³						
R84 ³						
R86 ³						
R90 ⁴						
R91 ⁴						
R93 ⁴						
R94 ⁴						
R96 ⁴						
R98 ⁴						

Switch

SW27	260-0643-00	Toggle	OFFSET
------	-------------	--------	--------

Transformer

T75	*120-0544-00	Toroid, 2 windings
-----	--------------	--------------------

³Furnished as a unit with 10X Attenuator Head (010-0364-00)⁴Furnished as a unit with 100X Attenuator Head (010-0365-00)

FIGURE AND INDEX NUMBERS

Items in this section are referenced by figure and index numbers to the illustrations which appear either on the back of the diagrams or on pullout pages immediately following the diagrams of the instruction manual.

INDENTATION SYSTEM

This mechanical parts list is indented to indicate item relationships. Following is an example of the indentation system used in the Description column.

Assembly and/or Component
Detail Part of Assembly and/or Component
mounting hardware for Detail Part
Parts of Detail Part
mounting hardware for Parts of Detail Part
mounting hardware for Assembly and/or Component

Mounting hardware always appears in the same indentation as the item it mounts, while the detail parts are indented to the right. Indented items are part of, and included with, the next higher indentation.

Mounting hardware must be purchased separately, unless otherwise specified.

PARTS ORDERING INFORMATION

Replacement parts are available from or through your local Tektronix, Inc. Field Office or representative.

Changes to Tektronix instruments are sometimes made to accommodate improved components as they become available, and to give you the benefit of the latest circuit improvements developed in our engineering department. It is therefore important, when ordering parts, to include the following information in your order: Part number, instrument type or number, serial or model number, and modification number if applicable.

If a part you have ordered has been replaced with a new or improved part, your local Tektronix, Inc. Field Office or representative will contact you concerning any change in part number.

Change information, if any, is located at the rear of this manual.

ABBREVIATIONS AND SYMBOLS

For an explanation of the abbreviations and symbols used in this section, please refer to the page immediately preceding the Electrical Parts List in this instruction manual.

INDEX OF MECHANICAL PARTS LIST ILLUSTRATIONS

(Located behind diagrams)

FIG. 1 EXPLODED

FIG. 2 STANDARD ACCESSORIES

SECTION 7

MECHANICAL PARTS LIST

FIG. 1 EXPLODED

Fig. & Index No.	Tektronix Part No.	Serial/Model Eff	No. Disc	Q					Description
				y	1	2	3	4	
1-	015-0120-00			1					SAMPLING HEAD, w/o probe
	- - - - -			-					sampling head includes:
-1	333-1059-00			1					PANEL, front
	- - - - -			-					mounting hardware: (not included w/panel)
-2	211-0022-00			1					SCREW, 2-56 x 3/16 inch, RHS
-3	386-1338-03			1					PLATE, sub-panel, front
-4	260-0643-00			1					SWITCH, toggle-OFFSET RANGE
	- - - - -			-					mounting hardware: (not included w/switch)
-5	361-0184-00			1					SPACER, ring
-6	210-0940-00			1					WASHER, flat, 1/4 ID x 3/8 inch OD
-7	210-0562-00			1					NUT, hex., 1/4-40 x 5/16 inch
-8	105-0066-00			1					STRIKE, latch
-9	384-0687-00			1					SHAFT, latch
-10	352-0139-00			2					HOLDER, circuit board
	- - - - -			-					mounting hardware for each: (not included w/holder)
-11	213-0012-00			1					SCREW, thread cutting, 4-40 x 3/8 inch
-12	670-0190-00			1					ASSEMBLY, circuit board—PREAMP
	- - - - -			-					assembly includes:
	388-0986-00			1					BOARD, circuit
-13	136-0252-01			6					SOCKET, pin connector
-14	136-0263-01			12					SOCKET, connector pin
-15	670-0191-00			1					ASSEMBLY, circuit board—TERMINAL
	- - - - -			-					assembly includes:
	388-0987-00			1					BOARD, circuit
-16	131-0265-00			2					CONNECTOR, coaxial, female
-17	131-0582-00			2					CONNECTOR, receptacle
-18	131-0591-00			11					TERMINAL, pin, 0.89 inch long
-19	131-0594-00			3					TERMINAL, pin, 1.485 inches long
-20	670-0194-00			1					ASSEMBLY, circuit board—STROBE
	- - - - -			-					assembly includes:
	388-1017-00			1					BOARD, circuit
-21	131-0391-00			2					CONNECTOR, coaxial, male
-22	136-0252-01			6					SOCKET, pin connector
-23	136-0263-01			5					SOCKET, connector pin
-24	344-0061-00			2					CLIP, diode
-25	380-0125-00			1					HOUSING
	- - - - -			-					housing includes:
-26	131-0555-00			4					CONTACT
-27	386-1337-01	B010100	B010149	1					PANEL, rear
	386-1337-04	B010150		1					PANEL, rear
	- - - - -			-					mounting hardware: (not included w/panel)
-28	211-0141-00			4					SCREW, machine, 4-40 x 3/4 inch, PHS

FIG. 1 EXPLODED (cont)

Fig. & Index No.	Tektronix Part No.	Serial/Model Eff	No. Disc	Q					Description	
				y	1	2	3	4		5
1-29	010-0236-00			1						ASSEMBLY, PROBE & CABLE
	- - - - -			-						assembly includes:
-30	200-0372-00			1						CAP, protective
-31	204-0351-00			1						ASSEMBLY, body-tip
-32	343-0165-00			1						CLAMP, half, strain relief
-33	343-0164-00			1						CLAMP, half, strain relief
	- - - - -			-						mounting hardware: (not included w/clamp
-34	211-0100-00			2						SCREW, 2-56 x 3/4 inch, RHS
-35	210-0405-00			2						NUT, hex., 2-56 x 3/16 inch

SECTION 8

DIAGRAMS

The following symbols are used on the diagrams:



Screwdriver adjustment

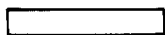

Front panel control or connector



Clockwise control rotation in direction of arrow

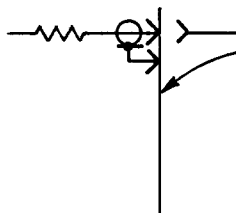

Blue line encloses components located on circuit board

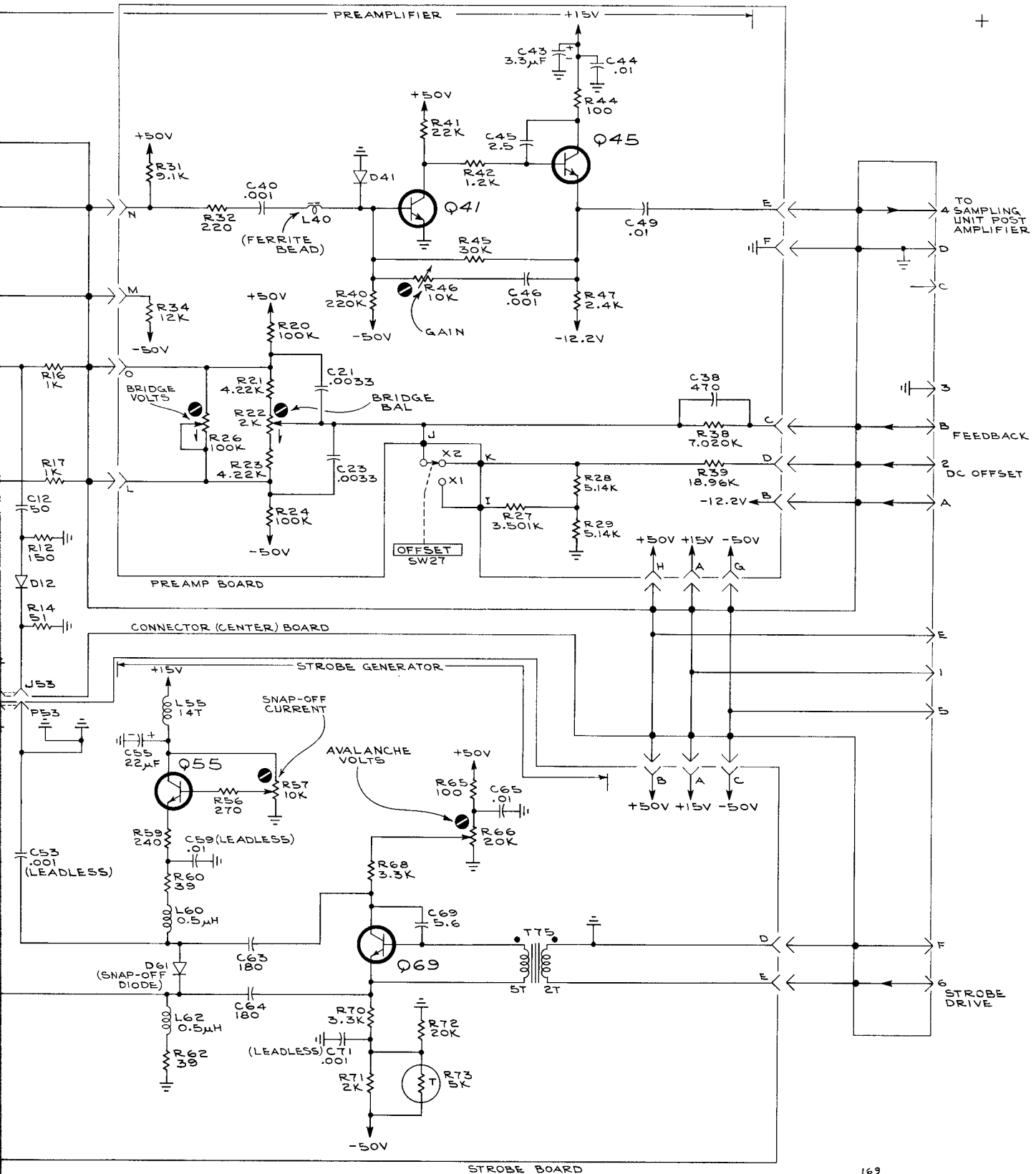

FIG. 1 EXPLODED

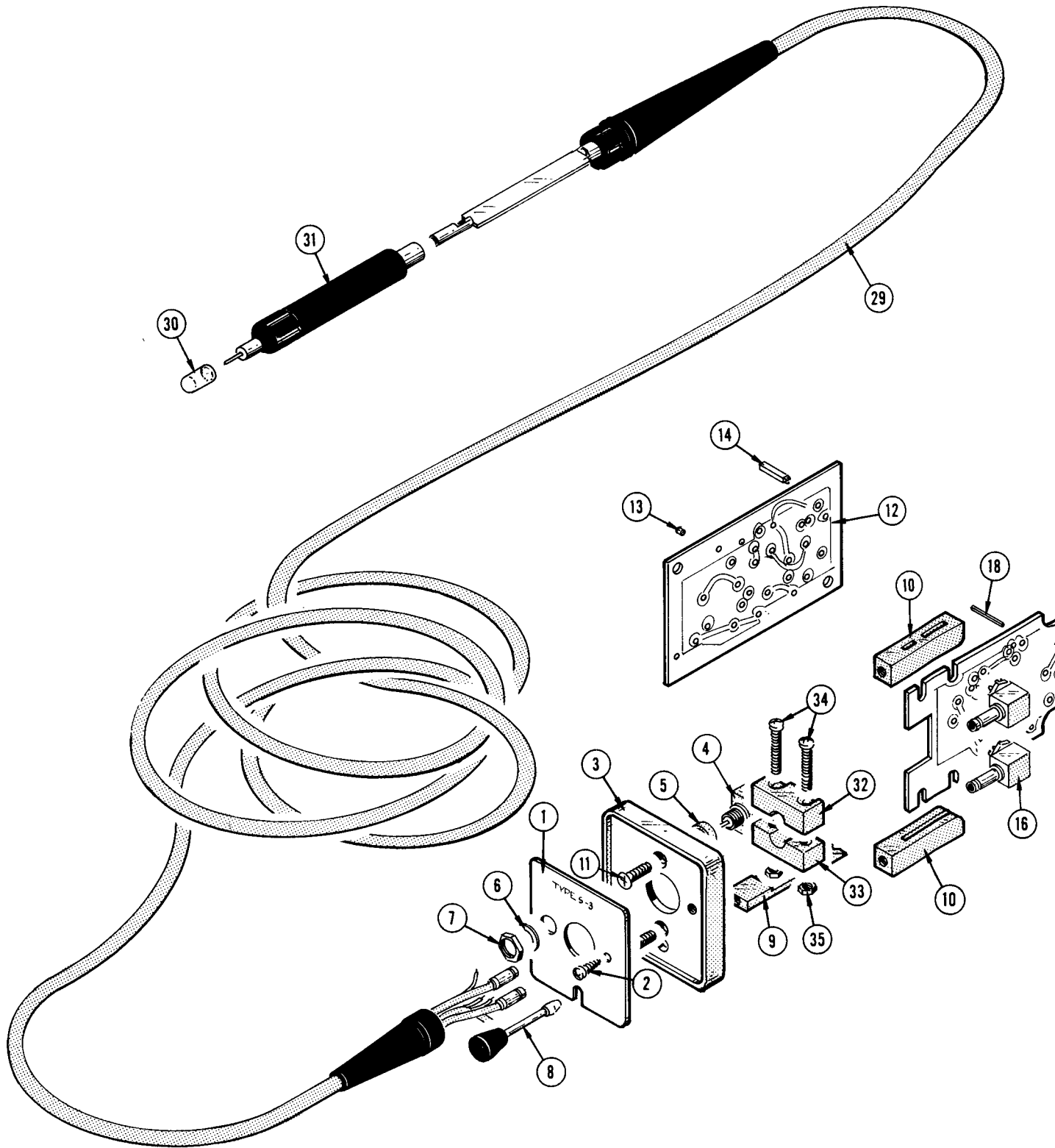
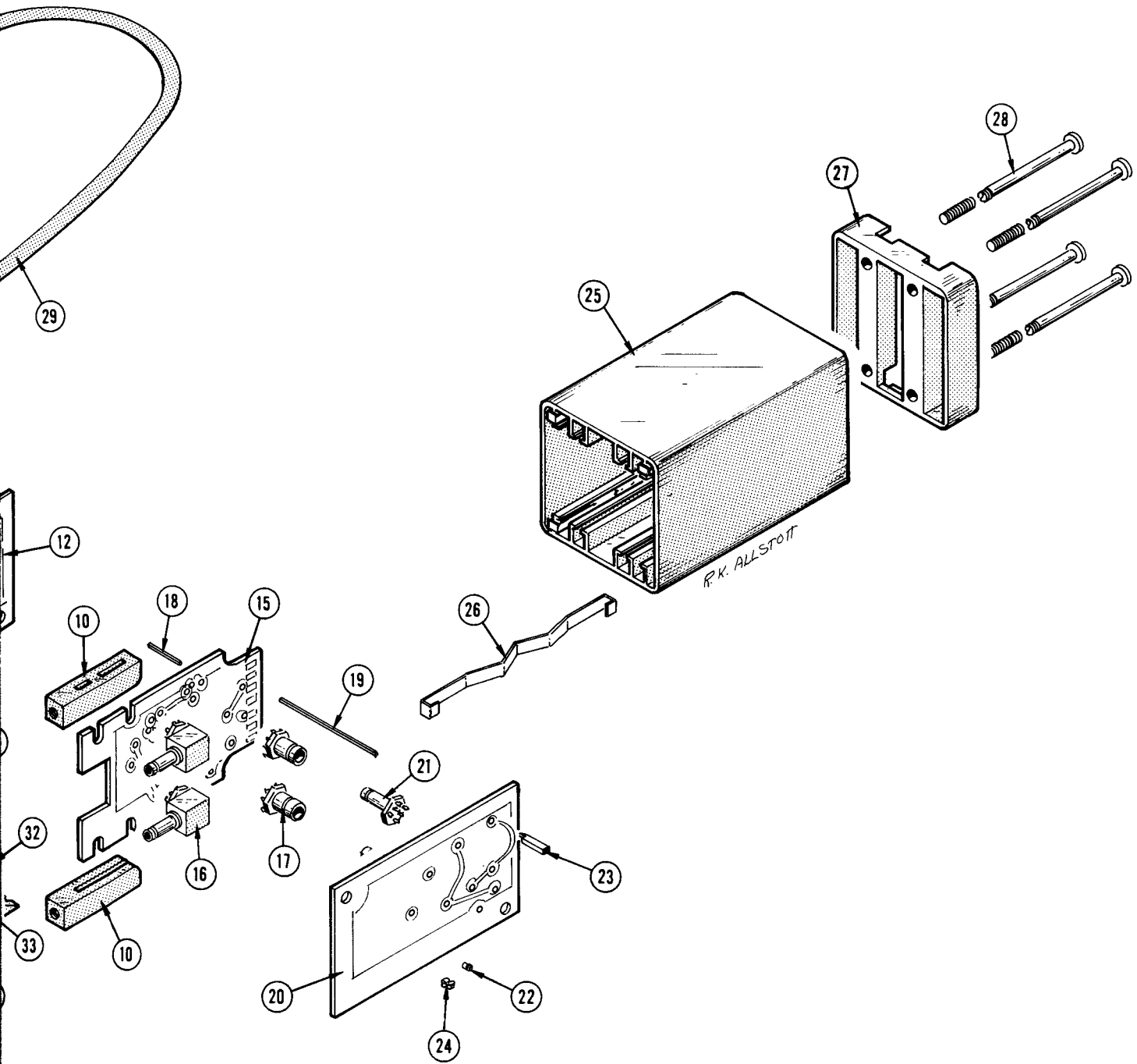

FIG. 1 EXPLODED

+



TYPE S-3 SAMPLING HEAD

FIG. 2 STANDARD ACCESSORIES

+

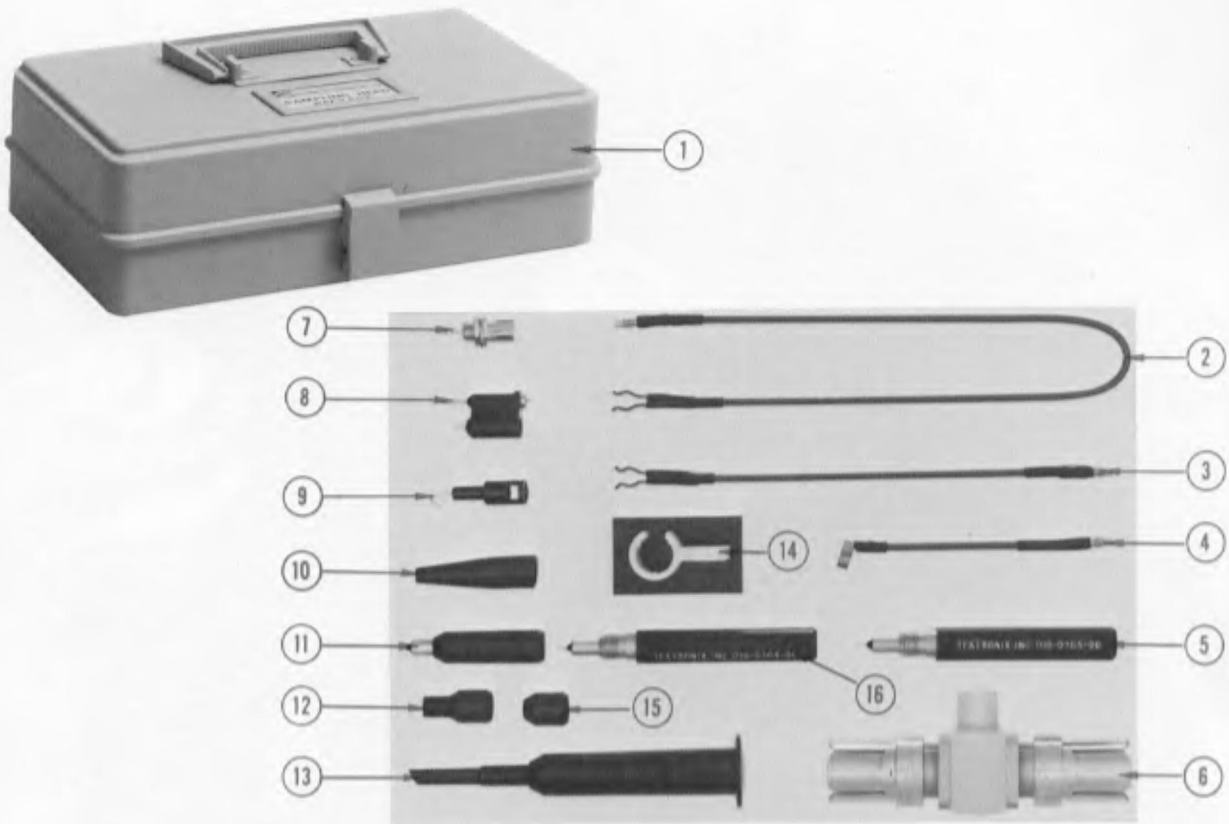

+A

Fig. & Index No.	Tektronix Part No.	Serial/Model No. Eff	Disc	Q † y						Description
					1	2	3	4	5	
2-1	016-0121-00			1						CARRYING CASE
-2	175-1018-00			1						LEAD, electrical, 12.5 inches long
-3	175-1017-00			1						LEAD, electrical, 5.5 inches long
-4	175-0249-00			1						CABLE ASSEMBLY, 3 inches long
-5	010-0365-00			1						ATTENUATOR HEAD, 100X
-6	017-0077-01			1						VOLTAGE PICKOFF
-7	131-0258-00			2						CONNECTOR, test point jack
-8	013-0085-00			1						ADAPTER, bayonet ground
-9	206-0114-00			1						TIP, probe (hooked)
-10	344-0046-00			3						CLIP, probe
-11	011-0098-00			1						CAPACITOR, coupling
-12	200-0834-00			1						CAP, end
-13	013-0097-00			1						TIP, probe, retractable hook
-14	352-0090-00			1						HOLDER, probe
-15	200-0835-00			2						CAP, end
-16	010-0364-00			1						ATTENUATOR HEAD, 10X
	070-0765-00			1						MANUAL, instruction (not shown)

AI

TYPE S-3 SAMPLING HEAD