

INSTRUCTION MANUAL

Serial Number _____

TYPE 2B67
TIME BASE

Tektronix, Inc.

S.W. Millikan Way • P. O. Box 500 • Beaverton, Oregon • Phone MI 4-0161 • Cables: Tektronix



CONTENTS

	Warranty
Section 1	Characteristics
Section 2	Operating Instructions
Section 3	Applications
Section 4	Circuit Description
Section 5	Troubleshooting
Section 6	Calibration
Section 7	Parts List and Schematics

A list of abbreviations and symbols used in this manual will be found on page 7-1.

Copyright © 1963 by Tektronix, Inc., Beaverton, Oregon. Printed in the United States of America. All rights reserved. Contents of this publication may not be reproduced in any form without permission of the copyright owner.



WARRANTY

All Tektronix instruments are warranted against defective materials and workmanship for one year. Tektronix transformers, manufactured in our own plant, are warranted for the life of the instrument.

Any questions with respect to the warranty mentioned above should be taken up with your Tektronix Field Engineer.

Tektronix repair and replacement-part service is geared directly to the field, therefore all requests for repairs and replacement parts should be directed to the Tektronix Field Office or Representative in your area. This procedure will assure you the fastest possible service. Please include the instrument Type and Serial number with all requests for parts or service.

Specifications and price change privileges reserved.



Type 2B67

Section 1

Characteristics

The Tektronix Type 2B67 Time-Base plug-in unit provides time-base deflection for Tektronix 560-Series oscilloscopes. It provides a triggered or free-running sweep, calibrated or continuously variable. The sweep may be triggered internally from either the vertical signal or the power line, or externally. Either repetitive or single-sweep operation may be selected. The Type 2B67 is normally used to provide the horizontal sweep for 560-Series oscilloscopes, but may be used to provide a vertical sweep, if desired. The unit is also provided with an input for external signals.

Sweep Rates

1 microsecond to 5 seconds per division in 21 calibrated steps. An uncalibrated control provides continuously variable sweep rates to about 3 times the step-switch setting. Calibrated sweep rates are within 3% of step-switch setting; magnified rates are within 5%.

Magnifier

Provides a 5-times expansion of the center 2 divisions of display, and extends the fastest sweep rate to 0.2 microsecond/division with 1% linearity after the first four divisions.

Triggering Modes

Internal, External, and Line. Trigger coupling may be selected from AC slow, AC fast, and DC, and triggering level and polarity are continuously adjustable. Triggering level

may be set to provide free-running or automatically triggered sweeps.

Triggering Signal Requirements

Internal Triggering: A signal producing two minor divisions of deflection.

External Triggering: A signal from 0.5 volt at dc to 2.0 volts at 2 mc. Sweep will trigger on larger signals, but LEVEL control limit is ± 10 volts.

Single Sweep

Single sweep may be selected, allowing sweep to operate only after manual reset for either triggered or free-running operation.

External Signal Input

Bandpass: Dc to about 750 kc, ± 3 db.

Sensitivity: About 1 volt/division.

Construction

Aluminum-alloy chassis.

Finish

Photo-etched anodized aluminum front panel.

Section 2

Operating Instructions

In the following instructions it is assumed that the Type 2B67 is inserted in the right-hand (X-axis) opening of the oscilloscope, thereby providing horizontal deflection of the trace. If it is inserted in the left-hand (Y-axis) opening of the oscilloscope it will provide vertical deflection and the instructions must be interpreted accordingly. It is further assumed that there is an amplifier plug-in unit in the left-hand opening of the oscilloscope.

Front-Panel Controls and Connectors

POSITION	Controls horizontal position of the crt display.
CALIBRATION	Adjusts amplifier gain to compensate for differences in crt deflection factors.
TIME/DIV.	Selects the desired sweep rate from a choice of 21 calibrated rates. In addition, an EXT. INPUT position is provided for connecting external signals.
VARIABLE	Provides a continuous range of sweep rates between the fixed steps of the TIME/DIV. switch. (The sweep rates are calibrated only when the VARIABLE control is set fully clockwise to the CALIBRATED position.) By pulling the VARIABLE control out, 5X magnification of the sweep is obtained.
UNCAL. Lamp	Lights when VARIABLE control is off CALIBRATED position to warn operator he is using an uncalibrated sweep rate.
EXT. INPUT	Input connector for application of external signals (TIME/DIV. switch must be in the EXT. INPUT position).
EXT. TRIG.	Input connector for external triggering signal.
STABILITY	Sets voltage level at input to Time-Base Generator to permit proper triggering by Time-Base Trigger.
LEVEL	Selects the voltage level on the triggering signal at which the sweep is triggered. This control also selects automatic triggering (AUTO. position) or allows the sweep to free run (FREE RUN position).
SLOPE	Selects whether the sweep starts on the positive-going portion (+ Slope) or negative-going portion (- Slope) of the triggering signal.
COUPLING	Selects AC Slow, AC Fast, or DC coupling of trigger input.
SOURCE	Selects the source of the triggering signal. INT. signal is obtained from the vertical plug-in unit. LINE signal triggers units at line frequency, and EXT. requires an externally-supplied signal.
MODE	Selects either normal triggered sweep or single sweep which must be reset with switch.

READY Lamp Lights when sweep is reset and ready to be triggered in the SINGLE SWEEP position of the MODE switch.

Sweep Triggering

To obtain a stable display, it is necessary to begin each sweep by reference to the input signal, or by some signal which bears a fixed time relationship to the input signal. The following instructions tell you how to select and use the proper triggering signal for various applications.

Selecting the Triggering Source

For most applications the sweep can be triggered by the input signal. The only requirement is that the display amplitude must be at least two minor graticule divisions. To trigger the sweep from the displayed signal, set the SOURCE switch to the INT. position.

Sometimes it is best to trigger the sweep with an external signal. To use an external signal for triggering the sweep, connect the trigger signal to the EXT. TRIG. connector and set the SOURCE switch to EXT. External triggering is especially useful where signals are measured from several different places within a device. By using external triggering, it is not necessary to reset the triggering controls each time a new waveform is shown. External triggering may also be used with a dual-trace amplifier in the alternate mode to show the proper time relationship between the two displayed signals. For a stable display, the external triggering signal should have an amplitude of at least one volt, peak-to-peak, and bear a fixed time relationship to the displayed signal.

To observe a signal that bears a fixed time relationship to the line frequency, you may wish to trigger the sweep from the line-frequency signal. To do this, place the SOURCE switch to the LINE position.

Selecting the Trigger Coupling

For most recurrent waveforms satisfactory triggering will be obtained with the COUPLING switch in the AC SLOW position. However, when triggering from very low frequencies (below about 16 cps), greater triggering sensitivity will be obtained with the COUPLING switch in the DC position. The AC FAST position of the COUPLING switch should be used to trigger only on the high-frequency component of a signal containing both high- and low-frequency components, and when using a dual-trace plug-in unit in the alternate mode with internal triggering.

With ac coupling, the sweep is triggered when the signal reaches a given amplitude with respect to its dc average. With dc coupling, the sweep is triggered when the signal reaches a definite dc amplitude.

Selecting the Trigger Slope

When the SLOPE switch is in the + position, the sweep is triggered on the positive slope of the triggering signal. When the SLOPE switch is in the - position, the sweep is triggered on the negative slope of the triggering signal (see Fig. 2-1).

Selecting the Trigger Level

The LEVEL control determines the instantaneous voltage level (ac or dc, depending on the setting of the COUPLING switch) on the triggering signal at which the sweep is triggered. With the SLOPE switch in the + position, adjustment of the LEVEL control makes it possible to trigger the sweep at virtually any point on the positive slope of the triggering signal. Likewise, with the SLOPE switch in the - position,

adjustment of the LEVEL control makes it possible to trigger the sweep at virtually any point on the negative slope (see Fig. 2-2).

At the extreme ends of its range, the LEVEL control activates the FREE RUN and AUTO switches. The effects of these switches are discussed in the following paragraphs.

Automatic Mode of Operation

With the LEVEL control set to AUTO., the Type 2B67 will trigger automatically on most signals. In this mode the triggering signal is ac-coupled, and the triggering level is automatically set. Normal amplitude internal or external triggering signals will trigger the sweep. In the absence of a triggering signal, the sweep triggers automatically at about a 50-cps rate.

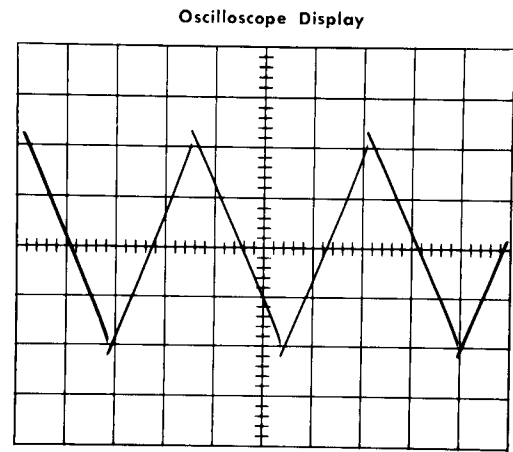
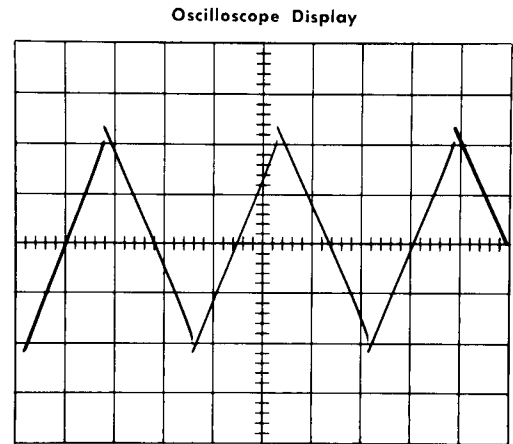
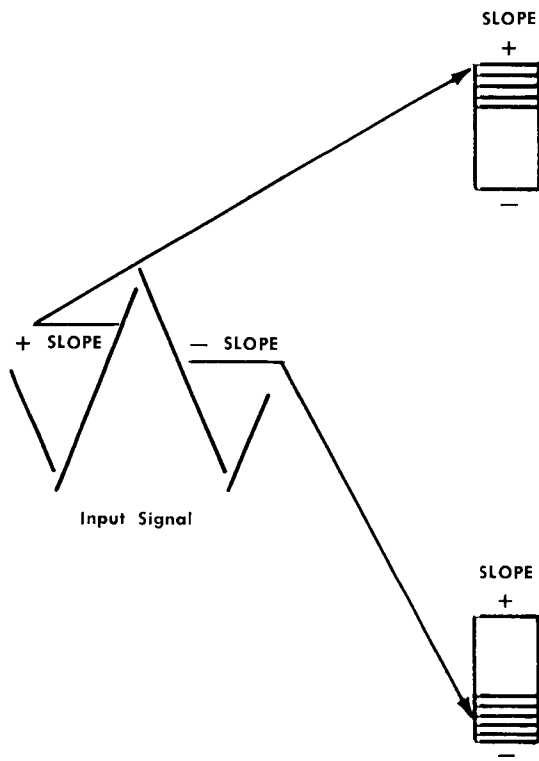

Fig. 2-1. Effect of SLOPE switch on display.

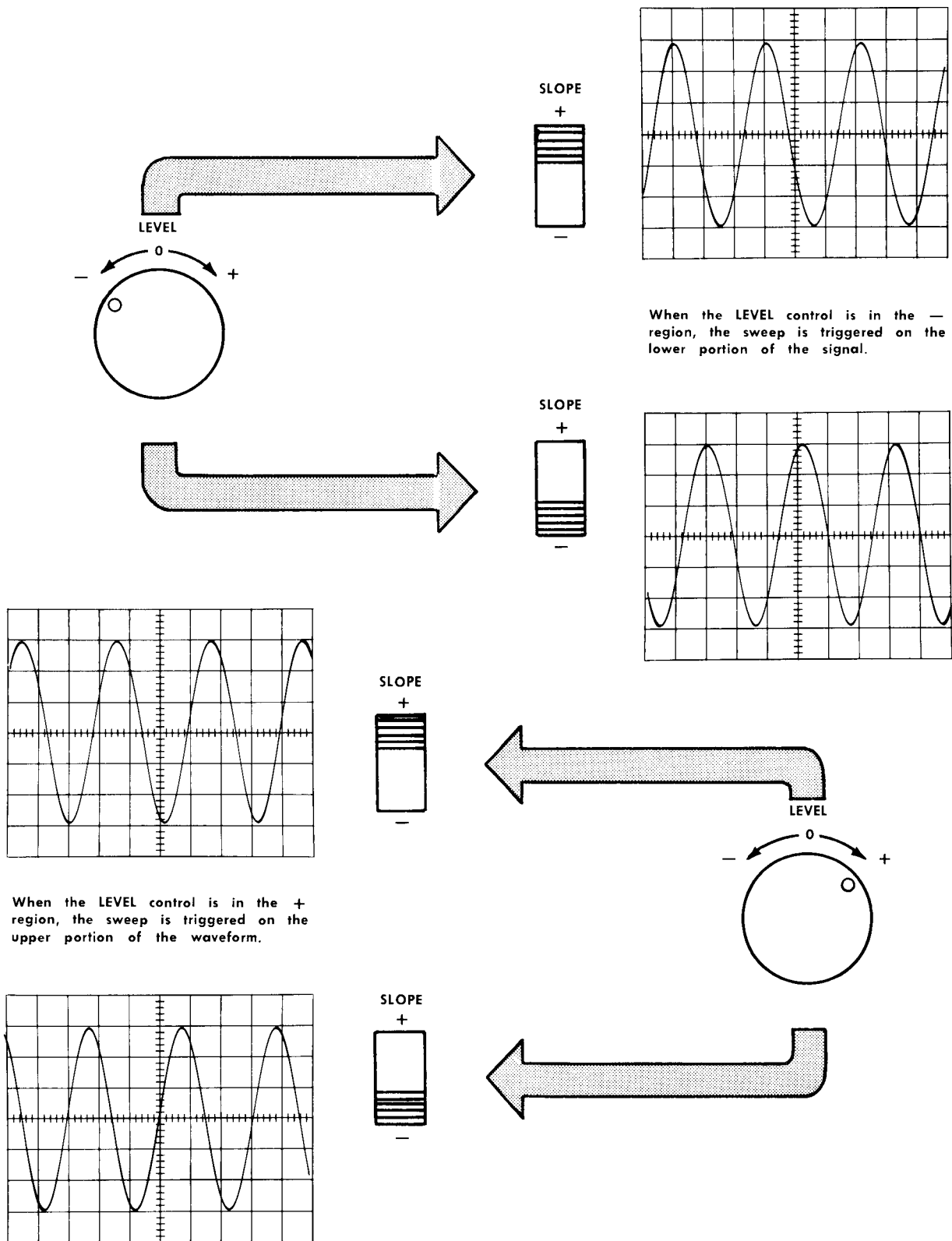

Fig. 2-2. Effect of the LEVEL control and SLOPE switch.

Free-Running Mode of Operation

Setting the LEVEL control to FREE RUN produces a free-running sweep, independent of any trigger signal. Frequency of the free-running sweep depends on the setting of the TIME/DIV. switch. A free-running trace is useful as a base line for making dc measurements.

Single Sweep Operation

The usual repetitive display is best for most applications. However, in applications where the displayed waveform is not repetitive in amplitude, slope, or time, a repetitive sweep produces a jumbled display. When observing a waveform of this type, it is usually advantageous to use a single-sweep presentation.

The Type 2B67 provides single-sweep operation so information can be recorded without confusion that could result from multiple traces. Single-sweep operation is selected by placing the MODE switch to SINGLE SWEEP.

When the LEVEL control is set to FREE RUN, a single sweep occurs immediately each time the MODE switch is pressed to the RESET position and released. With the LEVEL control set for triggered sweep, the single sweep does not occur until the first triggering signal after momentarily pressing the switch to RESET. The READY lamp lights after the sweep has been reset, indicating that the sweep is ready to be triggered. When a trigger signal occurs, the sweep runs, the READY light goes out, and the sweep waits until the switch is again pressed to RESET and released. Each time the sweep runs and the switch is pressed to RESET, the procedure is repeated.

When operating the Type 2B67 in the single-sweep mode, the apparent brilliance of the trace will be less than that during repetitive sweep operation. This is because the crt phosphor persistence makes a repetitive sweep look brighter than each individual sweep. In an attempt to increase the single-sweep brilliance you may increase the intensity too much. There is a point of maximum intensity above which a proper focus cannot be obtained. To get the best resolution

during single-sweep work, first be sure that the intensity is within the range where a small spot can be sharply focused.

Magnification of the Sweep

Any portion of the trace can be expanded horizontally five times by pulling the VARIABLE control knob out. To expand any portion of the trace, move the portion to be expanded to the center of the graticule with the POSITION control, and pull the VARIABLE control knob out.

To determine the true sweep rate in magnified sweep operation, divide the setting of the TIME/DIV. switch by five. (The VARIABLE control must be turned fully clockwise.)

Setting the CALIBRATION Adjustment

Any time you move the Type 2B67 from one oscilloscope opening to another, you must adjust the CALIBRATION adjustment to compensate for differences in crt deflection-plate sensitivities.

To properly set the Type 2B67 CALIBRATION adjustment in an oscilloscope with a line-frequency Calibrator, proceed as follows:

1. Set the TIME/DIV. switch to 5 mSEC and display a Calibrator signal on the crt.
2. Set the CALIBRATION adjustment so the number of cycles of Calibrator signal in 10 graticule divisions is equal to the line frequency times 50 milliseconds. (If the line frequency is 60 cps, there will be 3 cycles displayed in 10 divisions.)

If your oscilloscope does not have a line-frequency Calibrator, you can display a line-frequency waveform and set the CALIBRATION adjustment for the proper number of cycles.

In the Calibration instructions in this manual, there is another method of setting the CALIBRATION adjustment which is more accurate, but requires the use of a time-mark generator.

Section 3

Applications

Time Measurements

The calibrated sweep rates of the Type 2B67 Time Base make any horizontal distance on the crt represent a known time interval. This allows you to accurately measure the time between two displayed events directly from the crt. The following method is useful for most applications.

1. Measure the horizontal distance (on the graticule) between the two displayed events whose time interval you wish to find.

2. Multiply the distance measured by the setting of the TIME/DIV. switch to obtain the apparent time interval. (The VARIABLE control must be in the CALIBRATED position.)

3. Divide the apparent time interval by 5 if the 5X MAG. is on to obtain the actual time interval.

For example, assume the TIME/DIV. switch setting is 1 mSEC, the magnifier is on, and you measure 5 divisions between events. The 5 divisions multiplied by 1 millisecond per division equals an apparent time interval of 5 milliseconds. The apparent time divided by 5 then equals the actual time interval of 1 millisecond.

Frequency Measurements

Using the method described for time measurements, you can measure the period (time required for one cycle) of a recurrent waveform. The frequency of the waveform can then be calculated, since frequency is the reciprocal of the period. For example, if the period of a recurrent waveform is found to be 0.2 microsecond, the frequency is the reciprocal of 0.2 microsecond, or 5 mc.

At any given sweep rate, the number of cycles of the input signal displayed in 10 graticule divisions is dependent on the frequency of the signal. At a sweep rate of 1 microsecond per division, for example, 6 cycles are displayed for a 600-kc signal, 5 cycles for a 500-kc signal, and 4 cycles for a 400-kc signal. The frequency of a signal can usually be measured quicker, however, by the following method.

The frequency of a repetitive signal is equal to the reciprocal of the time (in seconds) for one cycle. Greater accuracy is possible by counting the total number of cycles for a 10-division display. Since the TIME/DIV. switch indicates the time for 1 division, multiply this setting by 10 to find the time required for 10 divisions.

To obtain the frequency of a repetitive input signal, perform the following steps:

1. Set the TIME/DIV. switch to display several cycles of the signal. Be sure the VARIABLE control is in the CALIBRATED position.

2. Count the number of waveform cycles shown in the 10 graticule divisions.

3. Divide this number by 10 times the TIME/DIV. switch setting. This equals the frequency of the signal.

For example, assume you are using a sweep rate of 50 milliseconds per division, and you count 7.2 cycles in 10 divisions. The frequency is equal to 7.2 cycles divided by 0.5 second (500 milliseconds), or 14.4 cycles per second.

Phase Measurements

Phase measurements can be obtained directly from the crt display. A complete cycle of a sinusoidal waveform is 360 degrees; therefore, it is possible to calibrate the oscilloscope display directly in degrees per division by means of the TIME/DIV. controls. For example, if the TIME/DIV. controls are adjusted so one cycle of the displayed waveform covers 9 divisions (see Fig. 3-1), each division corresponds to 40 degrees and the display is calibrated to 40 degrees per division.

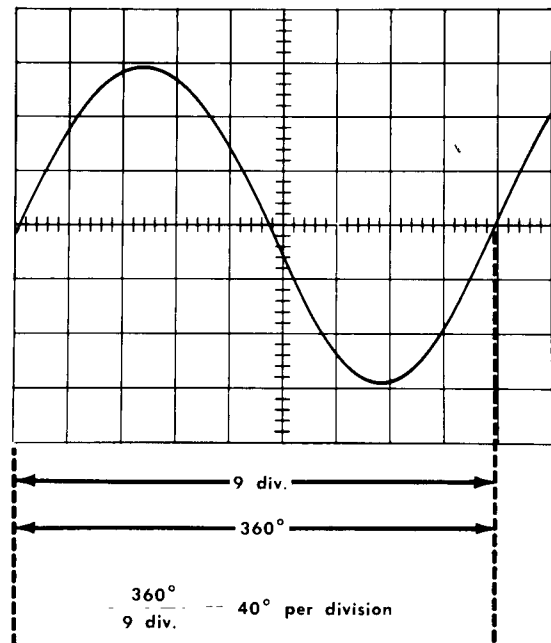

Fig. 3-1. One method for calibrating the oscilloscope display in degrees per division.

It is therefore possible to measure phase angles by: (1) calibrating the display in degrees per division; (2) measuring the displacement between corresponding points on the two phases; and (3) multiplying the displacement by the

Applications—Type 2B67

number of degrees per division. This is the method illustrated in Fig. 3-2. Note that the relative amplitude of the two signals does not affect the phase measurement when both signals are centered vertically about the graticule centerline. It is important to note that the two waveforms shown in the illustration do not appear simultaneously on the oscilloscope crt. The first waveform is displayed and positioned to a convenient reference point. The second waveform is then displayed and compared to the reference point.

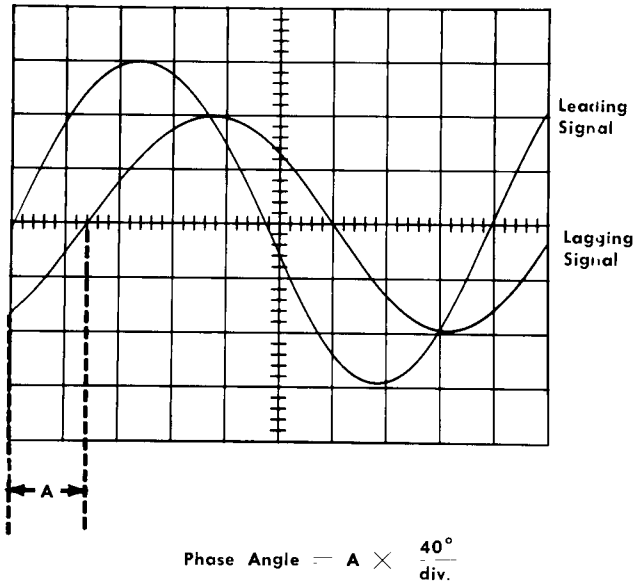

Fig. 3-2. Measurement of the phase angle between two electrical signals.

When using the Type 2B67 for phase measurements, it is necessary to supply an external triggering signal. This triggering signal serves, in a sense, as a reference signal. The two input signals are compared indirectly to the reference, and directly to each other. Consequently, the triggering stability must be maintained to permit accurate phase measurements. The external triggering signal must have sufficient amplitude to insure stable triggering, and it must be related in frequency to the signal on which phase measurements are to be made. If you wish, you can use one of the signals to be measured as the external triggering signal. Once the triggering conditions are established, they must not be changed during any phase measurement.

In most measurements it is very important that the width of the trace is not included. For best accuracy, the height of the display should be as large as possible, and the waveforms should be centered vertically about the centerline of the graticule.

A method for making phase measurements follows:

1. Connect the external triggering signal to the EXT. TRIG. connector. Set the SOURCE switch to EXT. and adjust the LEVEL control for a stable display.

2. Connect the first (leading) signal to the oscilloscope input. Adjust the TIME/DIV. controls so one cycle of the waveform covers exactly 9 graticule divisions. This corresponds to 40 degrees per division (as in Fig. 3-1).

3. Carefully center the displayed waveform about the graticule centerline using the Vertical Position control. Switch on the 5X MAG. and adjust the horizontal position of the trace so the displayed curve crosses the centerline vertically at the extreme left of the graticule. (See Fig. 3-3a.) The calibration now corresponds to 8 degrees per division.

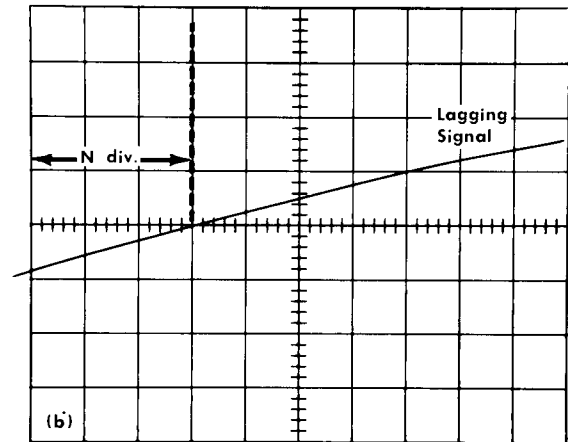
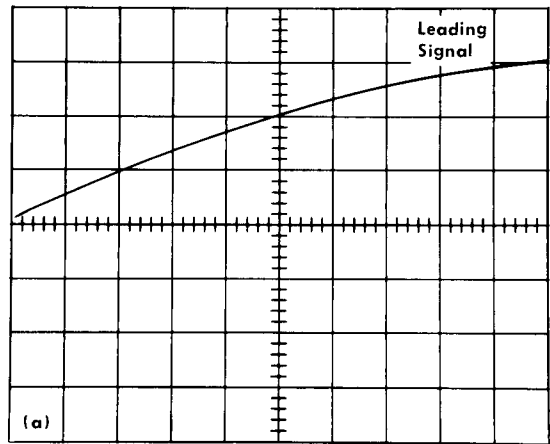

$$\text{Phase Angle} = N \text{ div.} \times \frac{8^\circ}{\text{div.}}$$

Fig. 3-3. (a) Establishing the reference point with the leading signal, and (b) computing the phase angle.

4. Disconnect the first signal and connect the second (lagging) one to the vertical amplifier input. The number of divisions to the right of the first waveform (at the point

where the curve crosses the centerline; see Fig. 3-3b), times 8 (the number of degrees per division), is the number of degrees of phase difference.

5. If a multitrace plug-in unit is used in the vertical circuit, the reference signal may be fed to Channel 1 and the lagging signal to Channel 2. Set up the horizontal position, using the Channel 1 signal, as in step 3, and set the mode for alternate display. The phase difference between the signals may be read directly since both signals are displayed simul-

taneously. Multitrace plug-in units allow the Channel 1 signal to trigger the Type 2B67 without an external connection, and therefore may be used to trigger the Type 2B67 internally in this application. Refer to the plug-in unit instruction manual for information.

6. If the phase difference between signals exceeds 80° , steps 3 and 4 must be performed with the 5X MAG. off, and the calibration will therefore correspond to 40 degrees per division.

Section 4

Circuit Description

Block Diagram

A block diagram of the Type 2B67 Time Base plug-in is shown in Fig. 4-1. In general, the Type 2B67 operates as follows:

A triggering signal (internal, external, or line) is applied to the Time-Base Trigger circuit. The Time-Base Trigger generates a negative trigger pulse coincident with a selected point on each cycle of the triggering signal. The negative pulse triggers the Time-Base Generator which generates a positive-going sawtooth. The sawtooth is amplified by the Horizontal Amplifier and applied push-pull to the crt deflection plates to sweep the beam across the screen. After the beam has travelled across the screen, the Time-Base Generator resets itself and awaits the next trigger. In single-sweep operation, the Time-Base Generator must be reset manually.

In the EXT. INPUT position of the TIME/DIV. switch, the Time-Base Generator is disabled and the output stage of the Horizontal Amplifier is connected to the front-panel EXT. INPUT jack.

TIME-BASE TRIGGER

The Time-Base Trigger (see schematic) consists of Trigger Input Amplifier V24 and the Trigger Multivibrator V15. The Trigger Input Amplifier amplifies (and, when desired, inverts) the incoming triggering signal and applies it to the Trigger Multivibrator. The Trigger Multivibrator is a Schmitt circuit that is switched from one state to the other by the signal at its input. Its square-wave output is differentiated to form negative and positive pulses that are applied to the Time-Base Generator. The negative pulses trigger the Time-Base Generator to start the sweep; the positive pulses are clipped by diode action and are not used.

Trigger Input Amplifier

The input to Trigger Input Amplifier V24 may be selected from one of three sources by means of SOURCE switch SW5. When the SOURCE switch is in the INT. position, the signal is obtained from the plug-in unit in the left-hand opening of the oscilloscope. When the SOURCE switch is in the EXT. position, the signal may be obtained from an external source through the EXT. TRIG. connector on the front panel. When the SOURCE switch is in the LINE position, the signal is obtained from one side of the 6.3-volt circuit supplying heater current to the tubes.

The negative pulse at the output of the Time-Base Trigger occurs only when there is a negative-going signal at the input of the Trigger Multivibrator (output of the Trigger Input Amplifier). To start the sweep during either a positive-going or negative-going portion of the incoming triggering signal, SLOPE switch SW20 provides either inverted or in-phase amplification of the triggering signal.

When the SLOPE switch is in the — position, the incoming signal is applied to the grid of V24A, and V24 operates as a cathode-coupled amplifier (output in phase with input). The negative pulse at the output of the Time-Base Trigger will therefore occur during a time when the triggering signal is moving in a negative direction.

When the SLOPE switch is in the + position, the incoming triggering signal is applied to the grid of V24B, and V24B operates as a plate-loaded amplifier (output opposite in polarity to input). The negative pulse at the output of the Time-Base Trigger now occurs during a time when the triggering signal is moving in a positive direction.

LEVEL control R17 varies the average dc level at the plate of V24B from about +102 volts to +123 volts. This is true whether the SLOPE switch is in the — or + position. The voltage at the plate of V24B must shift through the

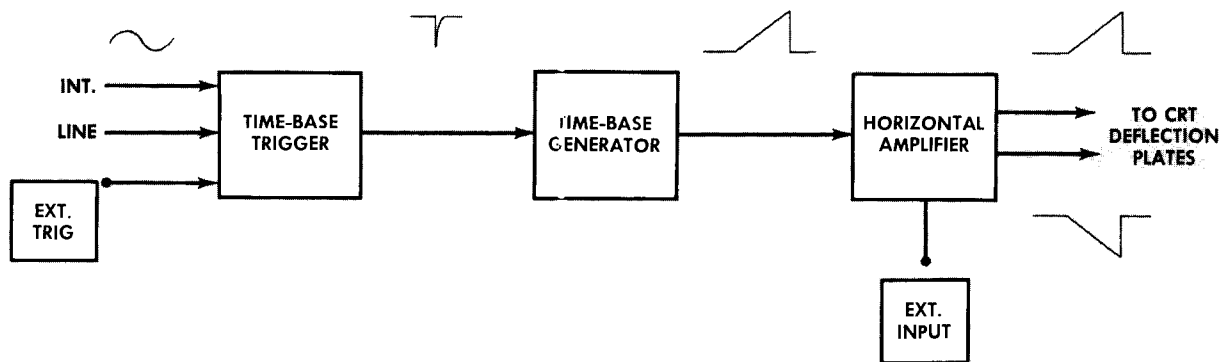

Fig. 4-1. Type 2B67 block diagram.

Circuit Description—Type 2B67

approximate center of this range (between about 111 and 113 volts) to force the Trigger Multivibrator to change states.

For small triggering signals, R17 is set so the average dc level at the plate of V24B is close to the center of its range. Then a small triggering signal, amplified by V24, is sufficient to carry the plate voltage through the approximate 112-volt point. When a large triggering signal is applied, and it is desired to trigger on an extreme positive or negative point of it, R17 is set so V24B is well into saturation, or cutoff, depending on whether triggering is desired on a negative or positive point on the signal and on a negative or positive slope. In this case, the triggering signal must be large enough to overcome the saturation or cutoff of V24B and produce an additional 10.5 volts of swing at the plate of V24B to force the Trigger Multivibrator to change states.

It should be noted that the voltages given in the foregoing discussion are nominal only, and will vary somewhat between instruments and with use.

Trigger Multivibrator

Trigger Multivibrator V45 is a two-state Schmitt circuit. When the voltage at the grid of V45A exceeds a certain level (about 113 volts) V45A conducts and V45B cuts off. In this state, the voltage at the output (plate of V45B) is -300 volts. When the voltage at the grid of V45A drops below a lower level (about 111 volts) V45A cuts off and V45B conducts. In this state, the voltage at the output is about $+280$ volts. The transition from one state to the other occurs very rapidly, regardless of how slowly the voltage at the input passes the critical levels (111 and 113 volts). The output of the Trigger Multivibrator is a 20-volt square wave. The negative-going portion of the square wave occurs when the voltage at the grid of V45A passes the lower critical level in a negative direction; the positive-going portion of the square wave occurs when the voltage at the grid of V45A passes the upper critical level in a positive direction. Only the negative-going portion of the square wave is used by the Time-Base Generator. By means of the SLOPE switch and the LEVEL control, this portion can be made to coincide with nearly any point on the incoming triggering signal.

The voltage level at the grid of V45A at which the Trigger Multivibrator changes states on a negative-going signal is slightly lower than the level at which it changes states on a positive-going signal. The difference between the two levels is called the "hysteresis" of the circuit. To maintain stable triggering, the incoming triggering signal must be large enough (after amplification in V24) to exceed the hysteresis.

Automatic Triggering Mode

When the LEVEL control is turned fully counterclockwise, AUTO. switch SW17 is activated and converts the Trigger Multivibrator from a bistable configuration to an astable (free-running) configuration. This is accomplished by coupling the grid circuit of V45A to the grid circuit of V45B via R40. The resulting time constant, in the absence of a triggering signal, causes the Trigger Multivibrator to free-run at about 50 cps. However, since signals from the Trigger Input Amplifier are still coupled to the Trigger Multivibrator through C31, any signal over 50 cps and of sufficient ampli-

tude will synchronize the Trigger Multivibrator at the signal frequency. In the absence of a triggering signal, the sweep continues to be triggered at a 50-cps rate.

TIME-BASE GENERATOR

The square-wave output of the Trigger Multivibrator is differentiated by C130-R130 to form negative and positive pulses. The negative pulses are the triggers which generate the sweep; the positive pulses are clipped by D130.

When the Time-Base Generator receives a trigger, it produces a linearly rising sawtooth voltage which is applied through the Horizontal Amplifier to the crt deflection plates. This deflects the electron beam across the screen and forms the sweep. The amplitude of the sawtooth is about 150 volts. Its rate of rise is controlled by the values of the Timing Capacitor and Timing Resistor.

The main circuits in the Time-Base Generator are the Sweep-Gating Multivibrator V135-V145A, the Miller Runup Circuit V161, and the Hold-Off Circuit V145B.

Sweep Generation

In the quiescent state—that is, when no sweep is being generated—V135A is conducting and V145A is cut off (MODE switch in NORM. position). The plate of V145A is at about -3 volts with respect to ground. Disconnect Diodes V152 are conducting and clamp the Timing Capacitor in the sweep discharged condition. The plate of V161A is at about $+28$ volts.

A negative trigger applied to the grid of V135A, from the Time-Base Trigger, will force the Sweep-Gating Multivibrator to rapidly switch states. That is, V135A cuts off and V145A conducts. This is similar to the operation of the Trigger Multivibrator. Subsequent triggers arriving at the grid of V135A have no effect on the circuit until after the sweep is completed and the multivibrator switches back to its original state.

As V145A conducts, its plate voltage drops, cutting off the Disconnect Diodes. The Timing Capacitor then starts to charge toward the instantaneous potential difference between the -100 -volt supply and the cathode of V161B. As the lower side of the Timing Capacitor starts to move in a negative direction, the grid of V161A moves with it. This produces a positive swing at the plate of V161A which is coupled through B167 and V161B to the upper side of the Timing Capacitor. This tends to prevent the lower side from moving negative, and increases the voltage to which the Timing Capacitor is trying to charge. The effect is to "straighten out" the charging curve by maintaining the charging current through the Timing Resistor with increasing charge on the capacitor. The result is an essentially linear sawtooth at the cathode of V161B, which is applied through the Horizontal Amplifier to the deflection plates of the crt.

The values of Timing Capacitor C160 and Timing Resistor R160 are selected by TIME/DIV. switch SW160. VARIABLE control R160Y allows additional resistance to be inserted in series with the Timing Resistor, which reduces the charging current and decreases the slope of the sawtooth. UNCAL. lamp B160W lights whenever the VARIABLE control is moved from the CALIBRATED position.

Sweep Length

The length of the sweep (the distance the spot moves across the crt) is determined by the setting of the SWP. LENGTH control R176. As the sweep voltage rises linearly at the cathode of V161B there will be a linear rise in voltage at the arm of the SWP. LENGTH control. This will increase the voltage at the plate and cathode of V152C and at the grid and cathode of V145B. As the voltage at the cathode of V145B rises, the voltage at the grid of V135A also rises. When the voltage at this point is sufficient to bring V135A out of cutoff, the Sweep-Gating Multivibrator will rapidly revert to its original state with V135A conducting and V145A cutoff. The voltage at the plate of V145A then rises, carrying with it the voltage at the plates of the Disconnect Diodes. As V152B conducts it provides a discharge path for C160 through R147 and the resistance in the cathode circuit of V161B. The plate voltage of the Miller Tube then falls linearly, under feedback conditions essentially the same as when it generated the sweep except for a reversal of direction. The resistance through which C160 discharges is much less than that of the Timing Resistor (through which it charges). The capacitor current for this period will therefore be much larger than during the sweep portion, and the plate of the Miller Tube will return rapidly to its quiescent voltage. This produces the retrace portion of the sweep sawtooth during which time the crt beam returns rapidly to its starting point.

Hold-Off

The Hold-Off Circuit prevents the Time-Base Generator from being triggered during the retrace interval. That is, the hold-off allows a finite time for the circuits to regain a state of equilibrium after the completion of a sweep.

During the trace portion of the sweep sawtooth the Hold-Off Capacitor charge through V152C as a result of the rise in voltage at the cathode of V161B. At the same time the grid of V135A is being pulled up, through V145B, until V135A starts conducting. This is the action that initiates the retrace. At the start of the retrace interval the Hold-Off Capacitor starts discharging through Hold-Off Resistor R181. The time constant of this circuit is long enough, however, so that during the retrace interval (and for a short period after the completion of the retrace) the Hold-Off Capacitor holds the grid of V135A high enough so that it cannot be triggered. However, when the Hold-Off Capacitor discharges to the point that V145B cuts off, it loses control over the grid of V135A and this grid returns to the level established by the STABILITY control. The hold-off time required is determined by the size of the Timing Capacitor. For this reason the TIME/DIV. switch changes the time constant of the Hold-Off Circuit simultaneously with the change of Timing Capacitors.

Sweep Stability

The divider consisting of the STABILITY control R111, R112, and R113 sets the quiescent dc level at the grid of V135A. R111 is adjusted so that the quiescent voltage at the grid of V135A is just high enough (with the FREE RUN switch open) to hold V135A in conduction. In this case a sweep can be produced only when a negative trigger drives V135A into cutoff. Turning the LEVEL control fully clockwise

closes the FREE RUN switch and shorts out R111. This places a more negative voltage on the grid of V135A such that this tube cuts off upon decay of the hold-off voltage and the next sweep is initiated immediately (no trigger is necessary). The result is a free-running sweep whose period is the total of the sweep time plus the hold-off time at any given setting of the TIME/DIV. switch. (This is compared to a fixed repetition rate of about 50 cps when the LEVEL control is turned fully counterclockwise to the AUTO. position to make the Trigger Multivibrator free run.)

Sweep Lockout

The Sweep Lockout circuit consists of transistor Q124 and associated components.

With the MODE switch at NORM., the base of Q124 and the anode of D126 are grounded. The emitter of Q124 has no ground return, and both emitter and collector are negative with respect to the base. Some current (about 0.4 ma) flows through the base-collector junction of Q124, setting the collector at about -80 volts. This reverse biases D124, since the grid of V135A runs between about -25 and -58 volts. When V135A conducts (grid at about -25 volts) the plate voltage is about $+14$ volts.

Placing the MODE switch to SINGLE SWEEP changes Q124 from a grounded-base to a grounded-emitter configuration. READY lamp B124 conducts and holds the collector of Q124 at about -55 to -60 volts. Conduction through R126 forward biases D126 and connects the base of Q124 to the plate of V135A. This reverse biases Q124 and "arms" the sweep . . . that is, V135A is ready to be triggered.

The next trigger to arrive at the grid of V135A will force the Sweep-Gating Multivibrator to switch states (V135A cut off; V145A conducting) and start a sweep. At the completion of the sweep, V135A again conducts and its plate voltage drops below ground. This forward biases Q124 (through D126) and drives it into saturation. Collector current then pulls up the collector of Q124 and the grid of V135A (through D124) to near ground. This extinguishes READY lamp B124 and drives V135A hard into saturation. With V135A in saturation, it is insensitive to incoming triggers and the sweep is "locked out".

Depressing the MODE switch to RESET transfers V135A plate current from the base of Q124 to ground. Current through R126 and D126 raises the base of Q124 slightly positive, which reverse biases Q124. The reduction in collector current then lets the grid of V135A fall to its "ready-to-be-triggered" level. The READY lamp then fires to indicate the sweep is again "armed", waiting for a trigger.

Unblinking

The positive rectangular pulse appearing at the cathode of V135B during sweep time is applied as an unblinking pulse to the crt. Action of this pulse on the crt circuit is discussed in detail in the oscilloscope instruction manuals. Blanking and unblinking is controlled only by the plug-in in the right-hand oscilloscope opening. Thus, if the Type 2B67 is inserted in the left-hand opening (producing a vertical trace), the trace will not be blanked between sweeps.

Circuit Description—Type 2B67

When the TIME/DIV. switch is in the EXT. INPUT position, the Sweep-Gating Multivibrator is disabled. The cathode of V135B rests at about +125 volts and the crt is continuously unblanked.

HORIZONTAL AMPLIFIER

The Horizontal Amplifier consists of the Input CF V333A, the Second CF V333B, Driver CF V353A, and the Output Amplifier V374.

The sweep sawtooth from the Time-Base Generator is coupled to the grid of V333A via the frequency-compensated voltage divider R320-R321. POSITION control R323 supplies a manually adjustable dc voltage to the grid of V333A for positioning the trace on the crt.

CALIBRATION adjustment R334 varies the sawtooth amplitude at the grid of V333B and provides a means for calibrating the sweep rate.

The output of V333B is coupled through R341 and R342 (in parallel with C341) to the grid of V353A. The cathode of V353A, in turn, drives the grid of V374A. V374 is a cathode-coupled paraphase amplifier that converts the single-

ended input to a push-pull output. The push-pull output is applied through pins 17 and 21 of the interconnecting plug to the crt deflection plates.

Negative feedback from the plate of V374A to the grid circuit of V353A develops a voltage across R341 and R342 that attenuates the signal from the cathode of V333B by a factor of five. When SW341 is closed (5X MAG. on), R341 and R342 are shorted out and the sweep rate, as seen at the crt deflection plates, is effectively magnified five times.

SWP./MAG. REGIS. adjustment R346 is adjusted to set the voltage at the grid of V353A equal to the voltage at the cathode of V333B when the electron beam is in the center of the crt and the 5X MAG. switch is open. With this configuration the center of the trace will not move as SW341 is opened and closed (5X MAG. turned off and on).

The EXT. INPUT position of the TIME/DIV. switch allows the application of external signals through the EXT. INPUT connector on the front panel. The external signal is applied directly to the Output Amplifier. When the TIME/DIV. switch is in the EXT. INPUT position, the POSITION control varies the dc voltage at the grid of V353B. This, in turn, sets the grid level of V374B.

Section 5

Troubleshooting

General maintenance and troubleshooting information is contained in the oscilloscope instruction manual. In the following discussion, it is assumed that you have read that information and have definitely isolated trouble to the Type 2B67.

First, remove the side panels of the oscilloscope and check for heater glow in all tubes. Replace tubes that have no heater glow. If there is still no heater glow in any tube, trace out the heater circuit to find the trouble.

If there is a heater glow in all tubes, remove the Type 2B67 and inspect it closely for damaged or burned components, loose wires, broken switches, etc. If visual inspection does not reveal the trouble, insert the Type 2B67 in the left-hand opening of the oscilloscope to obtain access to the wiring and components.

The Type 2B67 will produce a vertical sweep when it is inserted in the left-hand opening of the oscilloscope. For troubleshooting purposes you do not need a plug-in in the

right-hand opening (except to check triggering and blanking circuits). If you do not wish to exchange the position of the plug-in units, you may use a plug-in extension (Tektronix Part No. 013-034) which allows a plug-in to be operated while extended partially out of the oscilloscope.

The troubleshooting information in this section is contained in two tables. We suggest that you refer first to Table 5-1 to determine the major circuit (Time-Base Trigger, Time-Base Generator, or Horizontal Amplifier) the trouble is in. Then refer to Table 5-2 for instructions on troubleshooting that particular circuit. In each case, the information is further divided according to the symptoms the trouble presents to the operator.

NOTE

In case of insufficient horizontal deflection, non-linear sweep, or improper sweep timing, check the supply voltages in the oscilloscope first, especially the high voltage.

TABLE 5-1
CIRCUIT ISOLATION

TROUBLE	PROBABLE CAUSE	TESTS TO MAKE	NOTES
1. No sweep or insufficient horizontal deflection.	a. Time-Base Generator inoperative.	Set LEVEL to FREE RUN, MODE to NORM., POSITION to mid-range, TIME/DIV. to 10 mSEC, VARIABLE to CALIBRATED. B167 should glow, with definite periodic flicker.	No glow, or steady glow without flicker, indicates Time-Base Generator is not functioning; refer to Table 5-2, Part 2.
	b. Horizontal Amplifier	Set TIME/DIV. to EXT. INPUT. A spot should appear on crt. Connect a 2-volt signal from calibrator to EXT. INPUT connector and check for about 2 div. of deflection. If deflection is normal, check V333-V353 sections of Horizontal Amplifier, Table 5-2, Part 1.	If a 2-div. deflection (which will appear as 2 dots 2 div. apart) is not seen, check V353-V374 section of Horizontal Amplifier, Table 5-2, Part 1.
2. Sweep operates with LEVEL control in FREE RUN only.	a. STABILITY control out of adjustment.	Readjust STABILITY control (see Calibration, Section 6).	If sweep still only operates with LEVEL in FREE RUN, check trigger circuits in next step and refer to Table 5-2, Part 3.
	b. Trigger circuits inoperative.	Connect 20-volt signal from calibrator to EXT. TRIG. connector. Set SOURCE to EXT. Sweep should trigger with LEVEL control anywhere in $\pm 90^\circ$ range of \bigcirc , with any combination of SLOPE and COUPLING switches except — LEVEL and DC COUPLING combination.	If sweep triggers, but not over 90° range of LEVEL control, or if sweep cannot be triggered, refer to Table 5-2, Part 3.
3. Single Sweep does not function properly.	STABILITY control out of adjustment.	Readjust STABILITY control; see Calibration, Section 6.	Check Sweep-Lockout circuit, Table 5-2, Part 4.

TABLE 5-2
CIRCUIT TROUBLESHOOTING
Part 1. Horizontal Amplifier

TROUBLE	PROBABLE CAUSE	TESTS TO MAKE	NOTES
1. No trace.	Dc unbalance.	<p>a. If Time-Base Generator is working normally, try to position trace on screen with POSITION control. If still no trace, set TIME/DIV. switch to EXT. INPUT. If spot can be positioned on crt, trouble is between Time-Base Generator and cathode of V353A.</p> <p>b. If spot did not appear in last test, short together grids (pins 2 and 7) of V374. If spot now appears, trouble is in V353B circuit.</p>	<p>If no spot, set TIME/DIV. switch to 1 μSEC and MODE switch to SINGLE SWEEP. Turn POSITION control maximum cw. Ground following points in sequence: pin 7, V353; pin 3, V333; pin 2, V333; pin 8, V333; pin 7, V333. Components between last point checked which causes spot to appear on crt and point where no spot appears should be checked.</p> <p>If no spot appears, trouble is in V374 circuit.</p>
2. Insufficient or no deflection.	Low or no gain.	<p>a. If gain is low, check according to Calibration section of this manual. Change in gain will affect sweep timing, and recalibration will be necessary under any circumstances.</p> <p>b. Check components that can affect gain but not balance. Substitute known good tubes for V333, V353, V374 for test. Check R334, R342, R375.</p>	<p>If unit can be recalibrated, no further tests are necessary.</p>
3. Nonlinear amplification.	Nonlinear stage.	<p>a. Use 10X probe to couple signal to vertical amplifier plug-in unit, and set VOLTS/DIV. switch to 5 (deflection factor with probe: 50 volts/div.). Set LEVEL control to FREE RUN and connect probe to following points, in turn. Check for diagonal straight line on crt (slope is not important): Pin 8, V353; pin 3, V333, pin 8, V333.</p>	<p>At one of the points, the trace should become nonlinear. The trouble lies between this point and the previous point checked. If trace is linear at all points checked, trouble is in Time-Base Generator.</p>
Part 2. Time-Base Generator			
1. No Sweep	Miller Runup Circuit held at one point.	<p>a. Check voltage at pin 6, V161. If near +250 volts, refer to step b. If near +30 volts, refer to step c.</p> <p>b. Plate voltage near +250 volts. Ground grid of V161A (pin 2). Plate voltage should drop to about +6 volts. If plate voltage does not drop, replace V161 and check circuit of V161A. If plate voltage drops, replace V152.</p> <p>c. Plate voltage near +30 volts. Remove V152. If voltage runs up, runup circuit is okay. If voltage stays fixed, replace V161. If problem still exists, check plate circuit of V161A to determine cause of voltage drop.</p>	<p>If plate voltage is not near either +30 or +250 volts, press MODE switch to RESET. If plate voltage drops to +30 volts, remove V152. Plate should now run up near +250 volts. Replace V152 with a new tube and recheck.</p> <p>If replacing V152 does not fix trouble, check V161B circuit and Sweep-Gating Multivibrator V135-V145.</p> <p>If removing V152 allows plate voltage of V161A to run up, replace V152. If trouble persists, check Sweep-Gating Multivibrator V135-V145.</p>

TROUBLE	PROBABLE CAUSE	TESTS TO MAKE	NOTES
	Cathode follower V161B inoperative. Sweep-Gating Multivibrator faulty.	Check that B167 is lit and that that B161 is not. Check voltage at cathode of V161B (pin 8). It should be about 50 volts lower than the plate voltage of V161A at all times. a. If sweep is being held run up (plate voltage of V161A about +250 volts), and preceding tests show Runup circuit to be okay, monitor plate voltage at V145A (pin 6). Ground the grid (pin 2) of V135A. The V145A plate voltage should rise to about -3 volts. If it rises to 0 volts, replace V152. If grounding the grid of V135A allows the sweep to run down and then run up again, check feedback path through V152C and V145B. Ground plate of V152C (pin 8) and grid of V145B (pin 9). Sweep should reset. b. If sweep is being held run down, set LEVEL control to FREE RUN. Check grid voltage at V135A (pin 2). If it is -55 volts or more, plate of V145A should be -7 volts or more. If grid of V135A or plate of V145A does not meet conditions specified, remove V152 and recheck.	If B167 is not lit, replace it. If B161 is lit, V161B is not operating. Replace V161. If grounding grid of V135A does not raise plate of V145A to about -3 volts, replace V135 and V145 and recheck. Check supply voltages and component values in Sweep-Gating Multivibrator. If conditions are not met, and removing V152 allows conditions to be met, replace V152. If conditions still are not met with V152 removed, try replacing V135 and V145 and check supply voltages and components of Sweep-Gating Multivibrator.
2. Sweep does not retrace completely.	Hold-Off Capacitor not connected.	Check connections through TIME/DIV. switch which connect Hold-Off Capacitor (see Timing Switch diagram).	
Part 3. Time-Base Trigger			
1. Sweep runs only when LEVEL control in AUTO. or FREE RUN.	Trigger Input Amplifier inoperative.	Monitor plate voltage of V24B (pin 6). Set triggering controls for +/DC/EXT. triggering. Run LEVEL control back and forth over its range (not to AUTO. or FREE RUN). Plate voltage of V24B should range from about +102 volts with the LEVEL control near AUTO. to about +122 volts with the LEVEL control near FREE RUN.	If range is apparent, but voltages are out of about 102- to 122-volt region, check supply voltages and resistances in V24 circuit. If voltage does not move over about 20-volt range, but remains steady or nearly steady, replace V24 and check LEVEL control and SLOPE switch.
2. Sweep runs only with LEVEL in FREE RUN.	Trigger Multivibrator inoperative.	Monitor plate voltage of V45B (pin 6). With triggering controls set for ±/DC/EXT. triggering, and the LEVEL control near (but not in) FREE RUN, plate voltage of V45B should be about +295 volts. Move LEVEL control toward AUTO. As control moves through 0, the plate voltage of V45B should drop to about +275 volts. This change should be abrupt, indicating the the circuit has switched. Moving LEVEL control back near FREE RUN should cause a sharp rise to +295 volts again.	If voltage remains near +275 or +295 volts, and circuit does not switch, check V24 circuit (according to last step). Plate voltage of V24B must operate between about +102 and +122 volts for multivibrator to operate properly. Then, replace V45 and check supply voltages and components in V45 circuit.

Part 4. Sweep Lockout

TROUBLE	PROBABLE CAUSE	TESTS TO MAKE	NOTES
<p>1. Sweep does not lock out.</p>	<p>D125 open. Q124 inoperative.</p>	<p>Monitor base voltage of Q124. Set triggering controls so there is no triggering, and set the TIME/DIV. switch to .1 SEC. Set MODE switch to SINGLE SWEEP after first pressing it to RESET. Base of Q124 should be at about +16 volts. Move LEVEL controls momentarily to FREE RUN and return to former position after allowing sweep to start. Base of Q124 should rise to about +110 volts. When sweep ends, base of Q124 should drop to 0 volts.</p>	<p>If base of Q124 stays near +125 volts with MODE switch in SINGLE SWEEP, replace D126. If base of Q124 drops to +16 volts when sweep retraces, Q124 or D124 is at fault. To check D124, start the sweep again and connect a jumper across D124 while the sweep is running. If sweep locks out at end of trace, D124 is open. If lockout still does not operate, replace Q124.</p>
<p>2. Sweep runs as soon as MODE switch is returned from RESET to SINGLE SWEEP.</p>	<p>LEVEL or STABILITY control improperly set.</p>	<p>Check setting of LEVEL and STABILITY controls according to Calibration section of this manual.</p>	

Section 6

Calibration

Calibration of the Type 2B67 is performed with the plug-in unit inserted in the right-hand (X-axis) opening of a 560-Series Oscilloscope. An amplifier plug-in must be inserted in the left-hand (Y-axis) opening. In order to maintain its high degree of accuracy and linearity, we recommend that the Type 2B67 be calibrated after each 500 hours of operation or about every six months, whichever comes first.

Apparent trouble in the instrument may be the result of improper calibration. If trouble appears, you should make sure it is not due to improper calibration before proceeding with more detailed troubleshooting. Also, each calibration adjustment should be checked, and adjusted if necessary, whenever a component has been changed.

Because of interaction among some adjustments, we recommend that you calibrate the instrument in the order presented. Single adjustments should not be made. Front-panel controls not mentioned in a given step are assumed to be in the same position as in the previous step. Some adjustments affect the position of the crt display; therefore, it will be necessary to reposition the display with the POSITION control to keep time markers properly aligned with the graticule lines. All measurements with time markers should be between the 2nd and 9th graticule lines.

To obtain access to the adjustments, the right-hand side panel of the oscilloscope must be removed. Fig. 6-1 shows the internal adjustments of the Type 2B67 plug-in, viewed from the right side.

Equipment Required

The following equipment is required for a complete calibration of the Type 2B67 Time-Base.

1. Time-Mark Generator: Time markers at 1 and 10 microseconds, and at 1 and 5 milliseconds (accurate to within 1% [Tektronix Type 180 or 180A Time-Mark Generator recommended]).

2. Coaxial Cable: Suitable for applying the output of the time-mark generator to the input connector of the amplifier plug-in.

3. Low-Capacity Screwdriver: (Tektronix Part No. 003-000 or 003-001 recommended).

Initial Setup

Set the front-panel controls on the Type 2B67 as follows:

TIME/DIV.	.1 mSEC
VARIABLE*	CALIBRATED and pushed in (5X MAG. off)
LEVEL	AUTO.
SLOPE	+
COUPLING	AC SLOW
SOURCE	INT.
MODE	NORM.

*The VARIABLE control must remain in the CALIBRATED position for all timing adjustments. The UNCAL. lamp will light if the control is not in the CALIBRATED position.

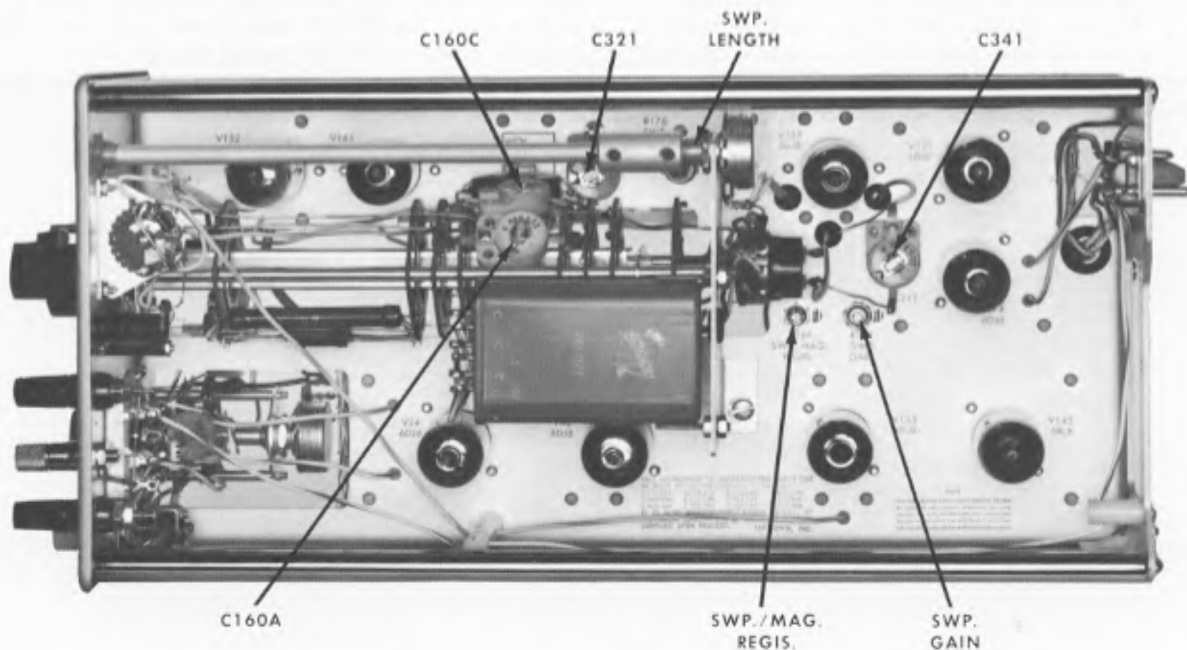

Fig. 6-1. Type 2B67 internal calibration adjustments.

Calibration—Type 2B67

STABILITY Adjustment

Ground the input of the amplifier plug-in in the left-hand opening of the oscilloscope. Set the Type 2B67 STABILITY control (front-panel screwdriver adjustment) fully counter-clockwise, then slowly clockwise until a trace appears on the crt. Note the position of the control. Advance the adjustment farther clockwise until the trace brightens. Finally, set the control about midway between the position where the trace first appears and the position where it brightens.

CALIBRATION Adjustment

Set the TIME/DIV. switch to 5 mSEC. Apply 1-millisecond markers to the input of the amplifier plug-in and adjust for about four divisions of vertical deflection. Center the display. Turn the 5X MAG. on (pull out the VARIABLE knob). Set the CALIBRATION control (front-panel screwdriver adjustment) for exactly one marker per major graticule division on the crt.

SWP. GAIN Adjustment

Turn the 5X MAG. off (push in the VARIABLE knob) and apply 5-millisecond markers to the amplifier plug-in. Adjust the SWP. GAIN control for exactly one marker per major graticule division.

SWP. LENGTH Adjustment

With the 5X MAG. off, adjust the SWP. LENGTH control for a total sweep length of about 10.5 graticule divisions.

SWP./MAG. REGIS. Adjustment

Turn the 5X MAG. on and position the trace horizontally so the first time marker is aligned with the centerline of the graticule. Turn the 5X MAG. off. Adjust the SWP./MAG. REGIS. control so the first time marker is again aligned with the centerline of the graticule. Repeat the adjustment until alignment is maintained.

10-, 20-, and 50-Microsecond/Division Sweep Rates

Set the TIME/DIV. switch to 50 μ SEC and turn the 5X MAG. on. Apply 10-microsecond markers to the input of the amplifier plug-in. Position the trace so the last 11 markers at the right-hand end of the trace are displayed on the crt. (The LEVEL control may have to be moved from the AUTO. position and adjusted for a stable display.) Adjust C160C for one marker per major graticule division.

Set the TIME/DIV. switch to 10 μ SEC and apply 1-microsecond markers to the input of the amplifier plug-in. (Be sure the 5X MAG. is on.) Position the display so the first 21 markers at the left-hand end of the trace are displayed. Adjust C321 for two markers per major graticule division.

1-, 2-, and 5-Microsecond/Division Sweep Rates

With the 5X MAG. on, set the TIME/DIV. switch to 5 μ SEC and the POSITION control to midrange. Adjust C160A for one marker per major graticule division.

Linearity Adjustment

Set the TIME/DIV. switch to 1 μ SEC and turn the 5X MAG. off. Position the display horizontally so the first time marker is aligned with the centerline of the graticule. Adjust C341 for one marker per major graticule division. This adjustment affects the first 4 divisions of display.

SINGLE SWEEP Check

Set the SOURCE switch to EXT. and the LEVEL control near, but not in, FREE RUN. Press the MODE switch to RESET and release. The READY lamp should light and remain on until the LEVEL control is moved through 0 toward AUTO. If proper operation is not obtained, recheck the setting of the STABILITY control.

Section 7

Parts List and Schematics

PARTS ORDERING INFORMATION

Replacement parts are available from or through your local Tektronix Field Office.



Changes to Tektronix instruments are sometimes made to accommodate improved components as they become available, and to give you the benefit of the latest circuit improvements developed in our engineering department. It is therefore important, when ordering parts, to include the following information in your order: Part number including any suffix, instrument type, serial number, and modification number if applicable.

If a part you have ordered has been replaced with a new or improved part, your local Tektronix Field Office will contact you concerning any change in part number.

ABBREVIATIONS AND SYMBOLS

a or amp	amperes	mm	millimeter
BHS	binding head steel	meg or M	megohms or mega (10^6)
C	carbon	met.	metal
cer	ceramic	μ	micro, or 10^{-6}
cm	centimeter	n	nano, or 10^{-9}
comp	composition	Ω	ohm
cps	cycles per second	OD	outside diameter
crt	cathode-ray tube	OHS	oval head steel
CSK	counter sunk	p	pico, or 10^{-12}
dia	diameter	PHS	pan head steel
div	division	piv	peak inverse voltage
EMC	electrolytic, metal cased	plstc	plastic
EMT	electrolytic, metal tubular	PMC	paper, metal cased
ext	external	poly	polystyrene
f	farad	Prec	precision
F & I	focus and intensity	PT	paper tubular
FHS	flat head steel	PTM	paper or plastic, tubular, molded
Fil HS	fillister head steel	RHS	round head steel
g or G	giga, or 10^9	rms	root mean square
Ge	germanium	sec	second
GMV	guaranteed minimum value	Si	silicon
h	henry	S/N	serial number
hex	hexagonal	t or T	tera, or 10^{12}
HHS	hex head steel	TD	toroid
HSS	hex socket steel	THS	truss head steel
HV	high voltage	tub.	tubular
ID	inside diameter	v or V	volt
incd	incandescent	Var	variable
int	internal	w	watt
k or K	kilohms or kilo (10^3)	w/	with
kc	kilocycle	w/o	without
m	milli, or 10^{-3}	WW	wire-wound
mc	megacycle		

SPECIAL NOTES AND SYMBOLS

X000	Part first added at this serial number.
000X	Part removed after this serial number.
*000-000	Asterisk preceding Tektronix Part Number indicates manufactured by or for Tektronix, or reworked or checked components.
Use 000-000	Part number indicated is direct replacement.
	Internal screwdriver adjustment.
	Front-panel adjustment or connector.

**MECHANICAL PARTS
PARTS LOCATOR**

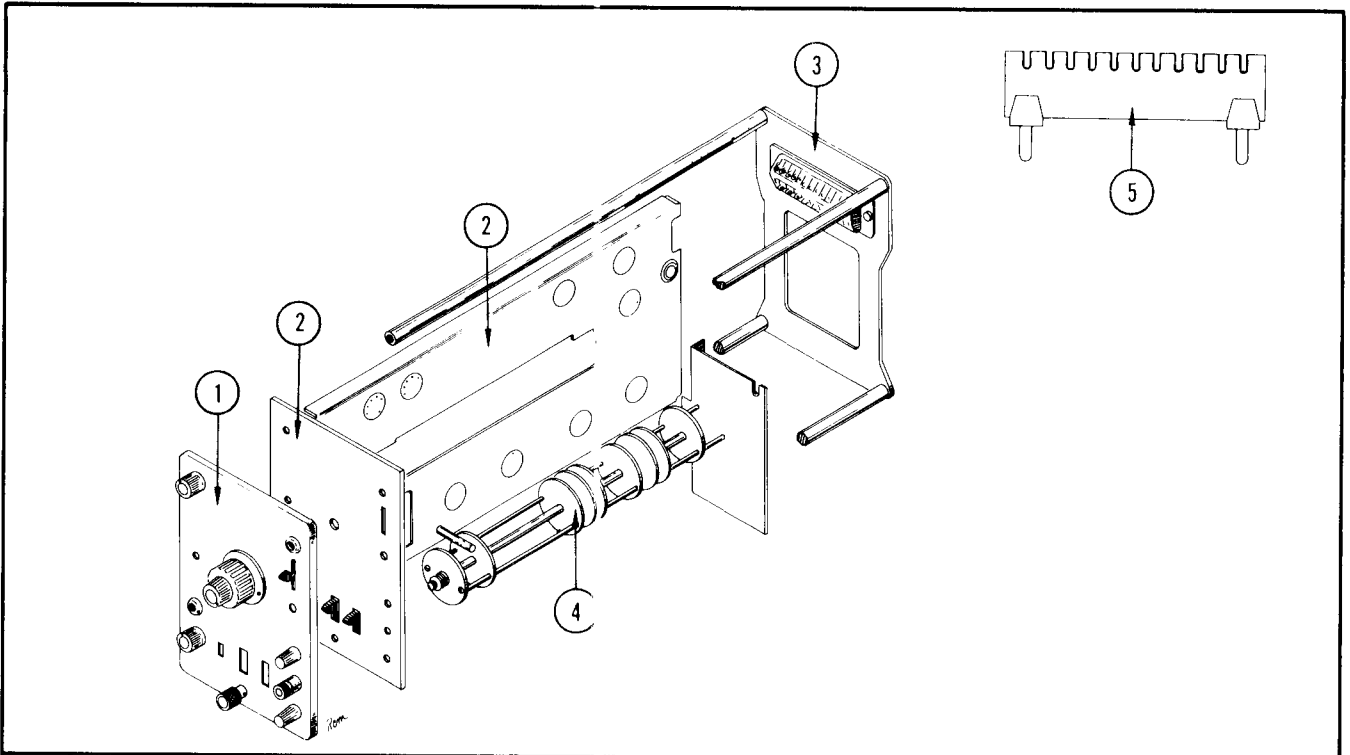

REF. NO.	PART NO.	SERIAL NO.		QTY.	DESCRIPTION
		EFF.	DISC.		
1.	Pg. 7-3				Front Group
2.	Pg. 7-4				Chassis Group
3.	Pg. 7-6				Rear & Frame Group
4.	Pg. 7-7				Switches
5.	Pg. 7-9				Strips

FRONT GROUP

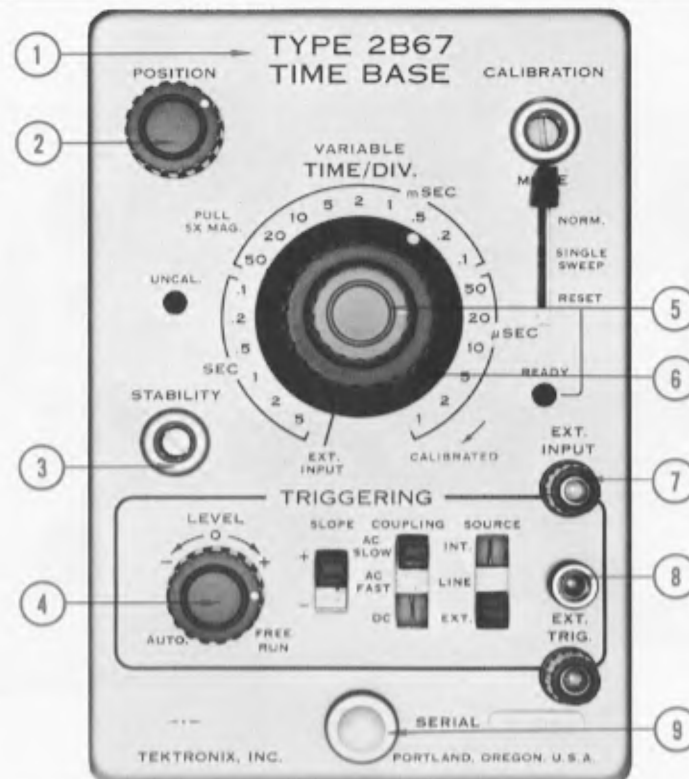

REF. NO.	PART NO.	SERIAL NO.		QTY.	DESCRIPTION
		EFF.	DISC.		
1.	333-727			1	PANEL, front
2.	366-113			1	KNOB, POSITION, charcoal
3.	213-004			1	Includes: SCREW, set, 6-32 x 3/16 in. HHS, allen head
	358-010			2	BUSHING, alum. 3/8-32 x 9/16 in. Mounting Hardware: (not included)
4.	210-413			1	NUT, hex, 3/8-32 x 1/2 in.
	366-113			1	KNOB, LEVEL, charcoal
5.	213-004			1	Includes: SCREW, set, 6-32 x 3/16 in. HHS, allen head
	366-038			1	KNOB, VARIABLE, red
6.	213-004			1	Includes: SCREW, set, 6-32 x 3/16 in. HHS, allen head
	366-144			1	KNOB, TIME/DIV. charcoal
7.	213-004			1	Includes: SCREW, set, 6-32 x 3/16 in. HHS, allen head
	129-065			2	POST, binding, assembly
	129-064			1	Each consisting of: POST, binding, miniature, 5 way, fluted cap
	210-408			2	NUT, hex, 6-32 x 5/16 in.
8.	358-181			1	BUSHING, nylon, charcoal
	129-020			1	POST, binding, assembly
	200-072			1	Consisting of: CAP, brass, 3/8 x 5/8 in.
	210-410			1	NUT, hex, 10-32 x 5/16 in.
9.	355-503			1	STEM, nickel plated
	366-109			1	KNOB, PLUG-IN SECURING, 9/16 in. alum. x 5/8 in.
	213-005			1	Includes: SCREW, set, 8-32 x 1/8 in. HSS, allen head

CHASSIS RIGHT SIDE

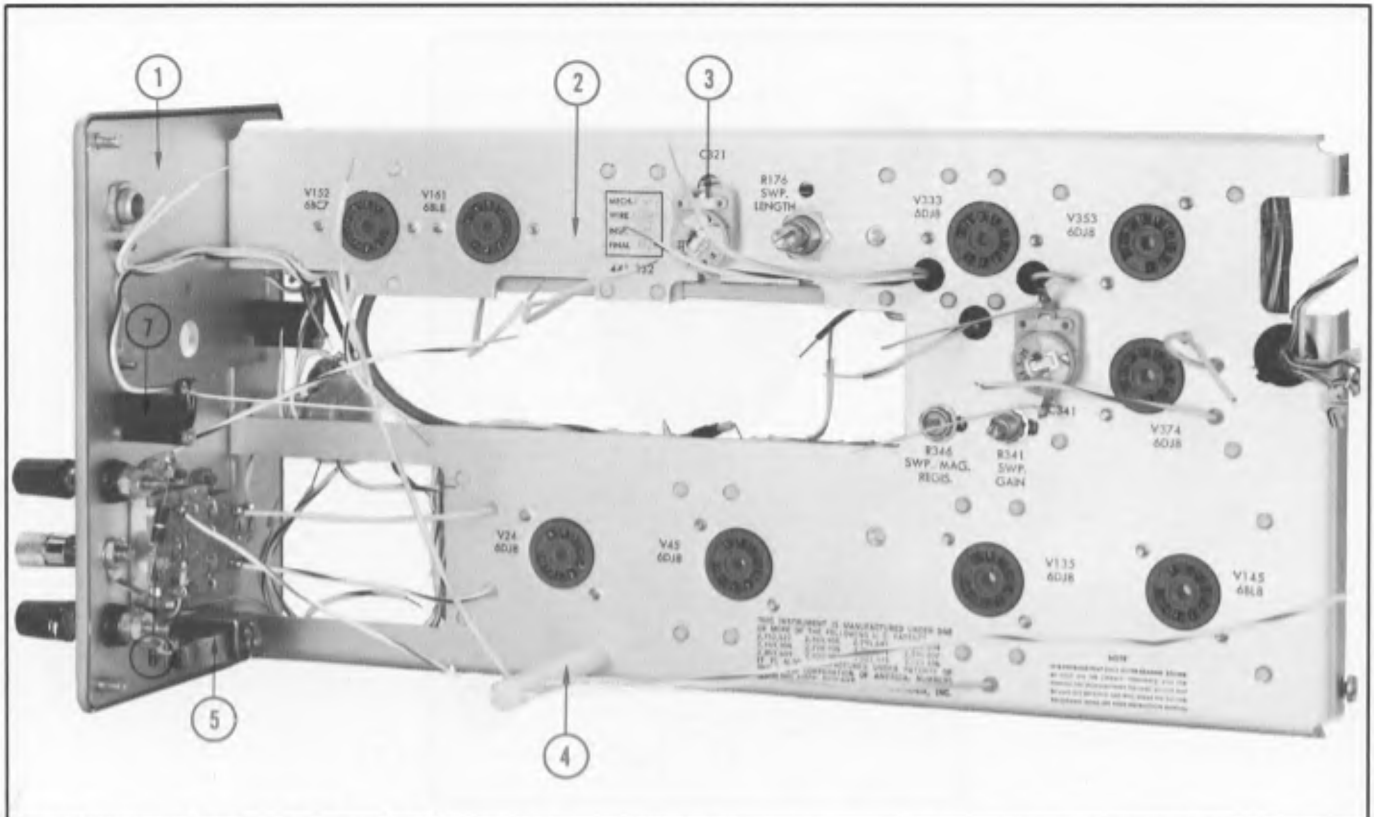

REF. NO.	PART NO.	SERIAL NO.		QTY.	DESCRIPTION
		EFF.	DISC.		
1.	387-731			1	PLATE, subpanel
2.	441-332			1	CHASSIS, 12 $\frac{1}{4}$ x 5 $\frac{1}{16}$ in.
	211-504			3	Mounting Hardware: (not included) SCREW, 6-32 x $\frac{1}{4}$ in. BHS
3. 214-153			1	Capacitor Mounting Hardware: FASTENER, snap, double pronged, delrin
4.	385-137			1	ROD, delin, $\frac{3}{16}$ x 2 $\frac{1}{4}$ in. with 3 cross holes
	213-041			1	Mounting Hardware: (not included) SCREW, thread forming, 6-32 x $\frac{3}{8}$ in. THS
5.	214-052			1	FASTENER, pawl right, with stop
	210-004			2	Mounting Hardware: (not included) LOCKWASHER, internal #4
	210-406			2	NUT, hex, 4-40 x $\frac{3}{16}$ in.
6.	Pg. 7-7				Switches
7.	352-008			2	HOLDER, melamine, neon bulb, single, black molded
	211-031			1	Mounting Hardware, Each: (not included) SCREW, 4-40 x 1 in. FHS
	210-406			2	NUT, hex, 4-40 x $\frac{3}{16}$ in.

CHASSIS LEFT SIDE

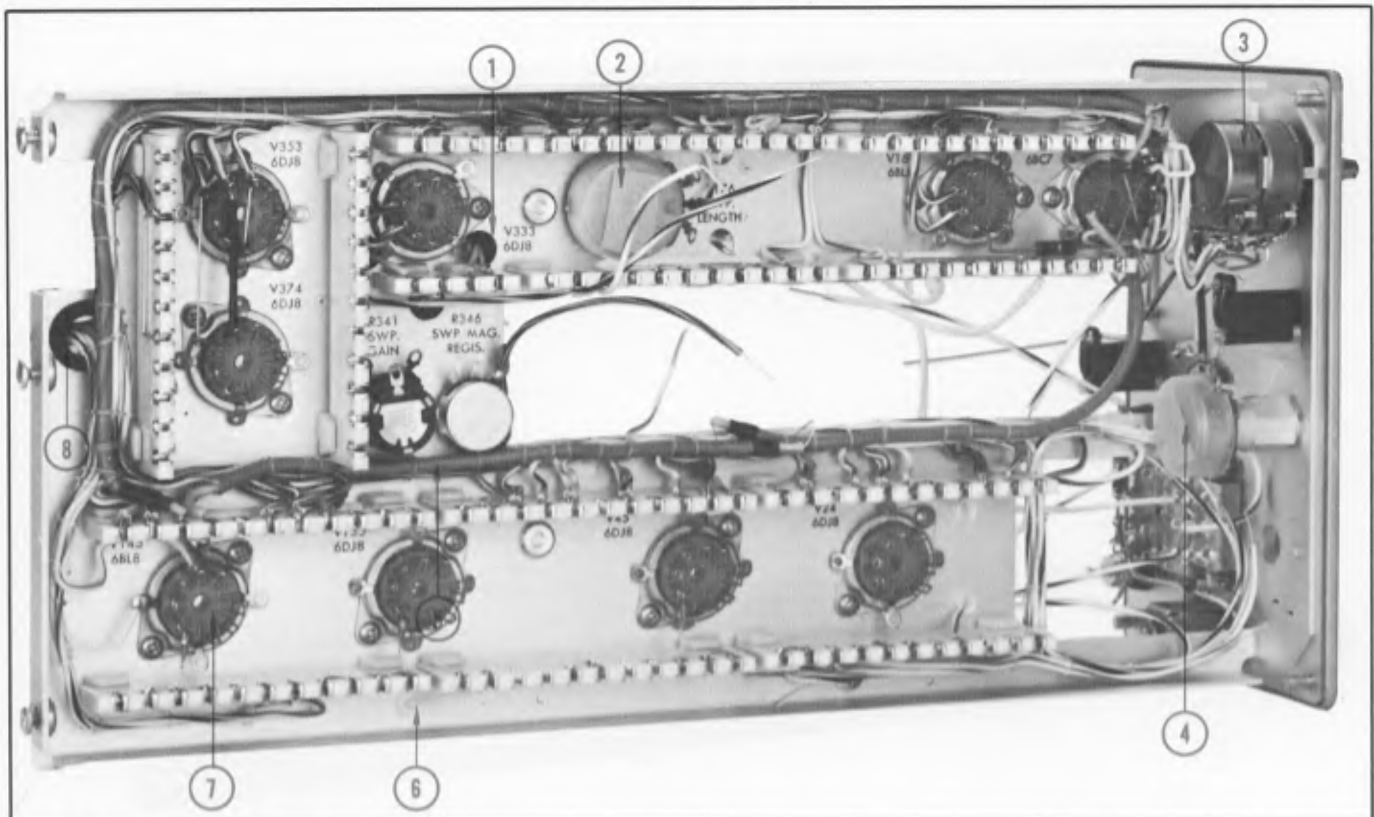

REF. NO.	PART NO.	SERIAL NO.		QTY.	DESCRIPTION
		EFF.	DISC.		
1.	348-002			3	GROMMET, rubber, 1/4 in.
2.	200-247			1	CAP, pot, polyethylene, 1 in. dia. Mounting Hardware: (not included)
	210-413			1	NUT, hex, 3/8-32 x 1/2 in.
	210-840			1	WASHER, pot, flat
3.	Pot Mounting Hardware:
	210-012			1	LOCKWASHER, pot, internal 3/8 x 1/2 in.
	210-413			1	NUT, hex, 3/8-32 x 1/2 in.
	210-840			1	WASHER, pot, flat
4.	200-247			1	CAP, pot, polyethylene, 1 in. dia. Mounting Hardware: (not included)
	210-494			1	NUT, hex, 3/8-32 x 1/2 x 1 1/16 in.
	210-012			1	LOCKWASHER, pot, internal, 3/8 x 1/2 in.
	210-413			1	NUT, hex, 3/8-32 x 1/2 in.
	210-840			1	WASHER, pot, flat
5.	179-697			1	CABLE, harness, chassis
6.	348-031			5	GROMMET, polypropylene, snap-in, 1/4 in. dia.
7.	136-015			9	SOCKET, STM9G Mounting Hardware, Each: (not included)
	213-044			2	SCREW, thread forming, 5-32 x 3/16 in. PHS
8.	348-005			1	GROMMET, rubber, 1/2 in.

REAR & FRAME GROUP

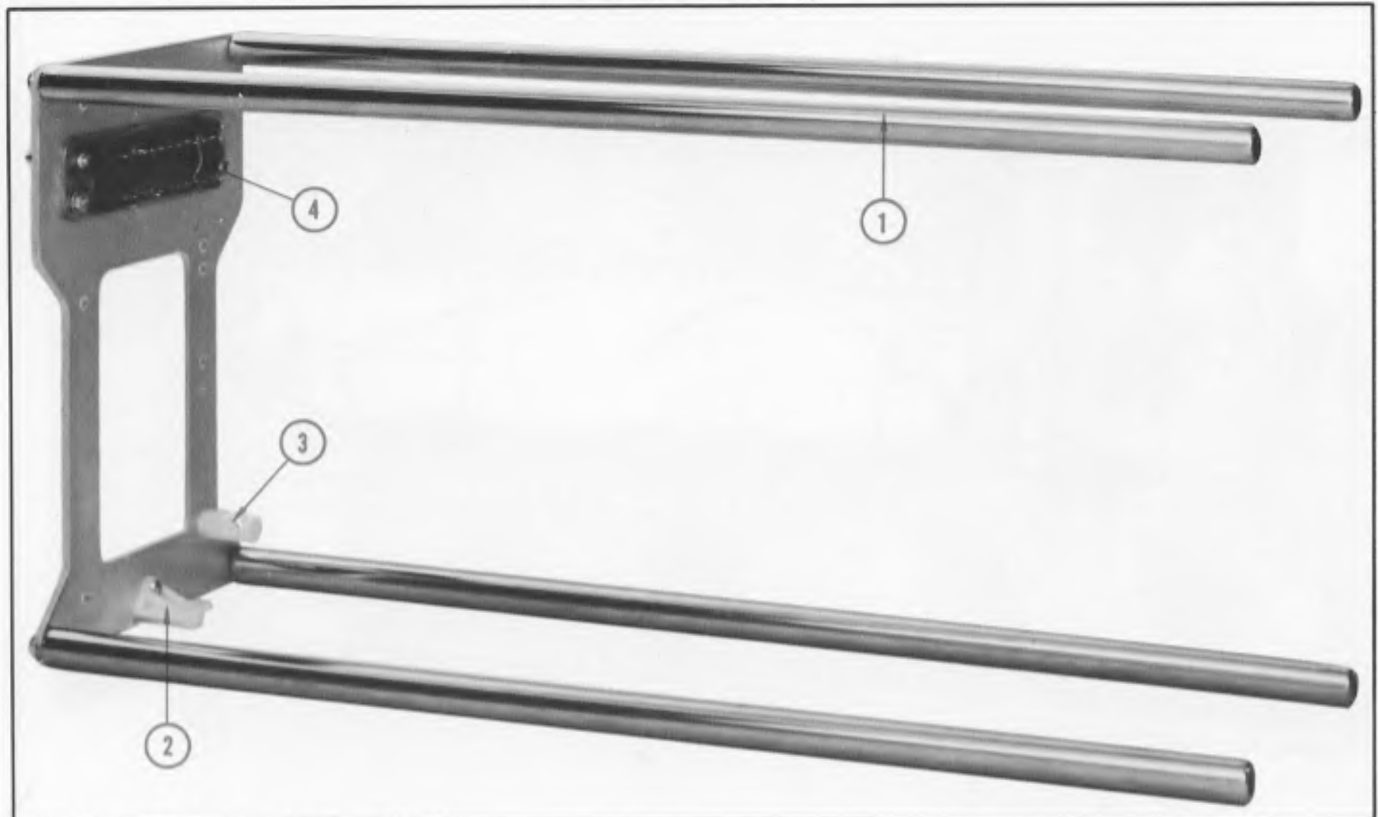

REF. NO.	PART NO.	SERIAL NO.		QTY.	DESCRIPTION
		EFF.	DISC.		
1.	384-566	100	7839	4	ROD, frame, spacing
	384-615	7840		4	ROD, frame, spacing
	212-044			1	Mounting Hardware, Each: (not included) SCREW, 8-32 x 1/2 in. RHS
2.	351-037			1	GUIDE, plug-in, delrin, 5/8 x 1 3/16 in. with 3/16 in. track
	211-013			1	Mounting Hardware: (not included) SCREW, 4-40 x 3/8 in. RHS
	210-004			1	LOCKWASHER, internal #4
	210-406			1	NUT, hex, 4-40 x 3/16 in.
3.	385-134			1	ROD, delrin, 5/16 x 5/8 in. with one cross hole
	213-041			1	Mounting Hardware: (not included) SCREW, thread forming, 6-32 x 3/8 in. THS
4.	131-149			1	CONNECTOR, chassis mount, 24 contact, male
	211-008			2	Mounting Hardware: (not included) SCREW, 4-40 x 1/4 in. BHS
	210-004			2	LOCKWASHER, internal #4
	210-406			2	NUT, hex, 4-40 x 3/16 in.

SWITCHES

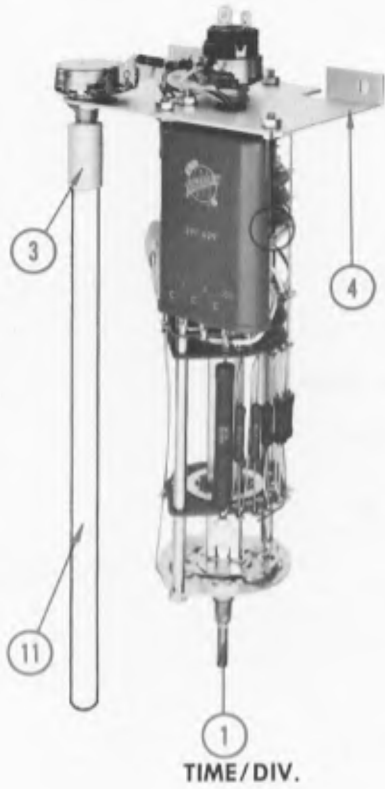

TIME/DIV.

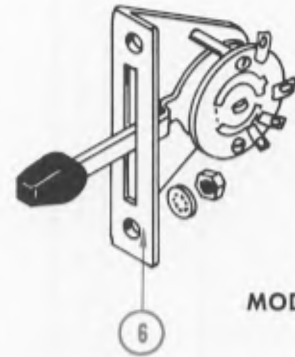

MODE

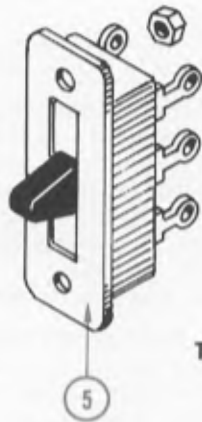

TRIGGERING SLOPE

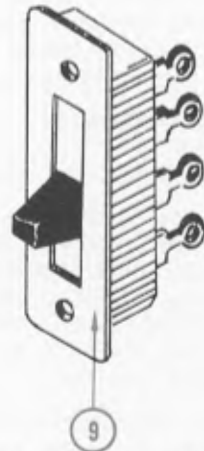

TRIGGERING COUPLING

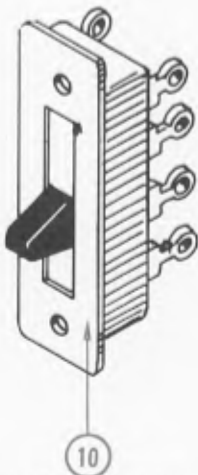

TRIGGERING SOURCE







LEVEL

SWITCHES





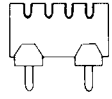
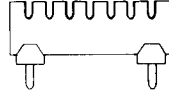

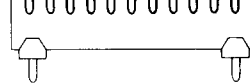
REF. NO.	PART NO.	SERIAL NO.		QTY.	DESCRIPTION
		EFF.	DISC.		
1.	262-371				SWITCH, TIME/DIV., wired Includes:
	179-508			1	CABLE, harness
	210-006			3	LOCKWASHER, internal #6
	210-012			2	LOCKWASHER, pot, internal, $\frac{3}{8} \times \frac{1}{2}$ in.
	210-202			1	LUG, solder, SE6, with 2 wire holes
2.	210-407			4	NUT, hex, 6-32 x $\frac{1}{4}$ in.
	210-413			2	NUT, hex, $\frac{3}{8}$ -32 x $\frac{1}{2}$ in.
	210-449			2	NUT, hex, 5-40 x $\frac{1}{4}$ in.
	210-840			1	WASHER, pot, flat
	213-048			1	SCREW, set, 4-40 x $\frac{1}{8}$ in. HHS, allen head
	348-003			1	GROMMET, rubber, $\frac{5}{16}$ in.
	166-354			1	SPACER, aluminum
3.	376-007			1	COUPLING, 1 in. long, with 2, 8-32 in. tapped holes Includes:
	213-005			2	SCREW, set, 8-32 x $\frac{1}{8}$ in. HHS, allen head
	384-226			1	ROD, extension, $8\frac{1}{4}$ in. long
4.	406-613			1	BRACKET, switch, rear, $3\frac{3}{16} \times 2\frac{1}{16} \times \frac{1}{2}$ in.
	260-352			1	SWITCH, TIME/DIV., unwired Mounting Hardware: (not included)
	210-012			1	LOCKWASHER, pot, internal, $\frac{3}{8} \times \frac{1}{2}$ in.
	210-413			1	NUT, hex, $\frac{3}{8}$ -32 x $\frac{1}{2}$ in.
	210-803			2	WASHER, flat, 6L x $\frac{3}{8}$ in.
	210-840			1	WASHER, pot, flat
	211-507			2	SCREW, 6-32 x $\frac{5}{16}$ in. BHS
5.	260-447			1	SWITCH, TRIGGERING SLOPE, unwired Mounting Hardware: (not included)
	210-004			2	LOCKWASHER, internal #4
	210-406			2	NUT, hex, 4-40 x $\frac{3}{16}$ in.
6.	260-501			1	SWITCH, MODE, unwired Mounting Hardware: (not included)
	210-004			2	LOCKWASHER, internal #4
	210-406			2	NUT, hex, 4-40 x $\frac{3}{16}$ in.
7.	262-372			1	SWITCH, LEVEL, wired Includes:
	210-012			1	LOCKWASHER, pot, internal, $\frac{3}{8} \times \frac{1}{2}$ in.
8.	210-413			1	NUT, hex, $\frac{3}{8}$ -32 x $\frac{1}{2}$ in.
	376-014			1	COUPLING, pot, wire, steel
	260-353			1	SWITCH LEVEL, unwired Mounting Hardware: (not included)
	210-012			1	LOCKWASHER, pot, internal, $\frac{3}{8} \times \frac{1}{2}$ in.
	210-413			1	NUT, hex, $\frac{3}{8}$ -32 x $\frac{1}{2}$ in.
	210-840			1	WASHER, pot, flat
9.	260-448			1	SWITCH, TRIGGERING COUPLING, unwired Mounting Hardware: (not included)
	210-004			2	LOCKWASHER, internal #4
	210-406			2	NUT, hex, 4-40 x $\frac{3}{16}$ in.
10.	260-450			1	SWITCH, TRIGGERING SOURCE, unwired Mounting Hardware: (not included)
	210-004			2	LOCKWASHER, internal #4
	210-406			2	NUT, hex, 4-40 x $\frac{3}{16}$ in.
11.	384-215			1	ROD, extension, $\frac{1}{4}$ in. dia. x $6\frac{5}{8}$ in. long

CERAMIC STRIPS AND MOUNTINGS



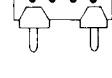

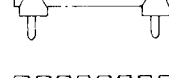
3/4 inch

	1 notch	124-100
	2 notch	124-036
	3 notch	124-037
	4 notch	124-038
	7 notch	124-039
	9 notch	124-090
	11 notch	124-091

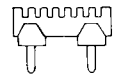
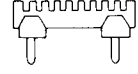

7/16 inch

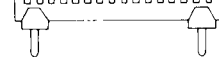
	1 notch	124-118
	2 notch	124-119
	3 notch	124-092
	4 notch	124-120
	5 notch	124-093
	7 notch	124-094
	9 notch	124-095
	11 notch	124-106





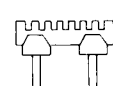
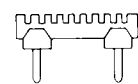
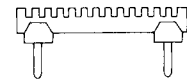

7/16 inch SMALL NOTCH —Short Stud

	7 notch	124-149
	9 notch	124-148
	13 notch	124-147
	16 notch	124-146
	20 notch	124-145

7/16 inch SMALL NOTCH —Tall Stud

	7 notch	124-158
	9 notch	124-157
	13 notch	124-156
	16 notch	124-155
	20 notch	124-154

MOUNTINGS

	Stud, nylon, short..355-046
	Stud, nylon, tall .. 355-082
	Spacer, 1 1/32 inch..361-039
	Spacer, 3/8 inch .. 361-009
	Spacer, 1/4 inch...361-008
	Spacer, 5/32 inch...361-007

Ceramic strips include studs, but spacers must be ordered separately by part no.

ELECTRICAL PARTS

Values are fixed unless marked Variable.

Ckt. No.	Tektronix Part No.	Description	S/N Range
BULBS			
B124	150-027	Neon, NE-23	READY
B160W	150-027	Neon, NE-23	UNCAL.
B161	150-027	Neon, NE-23	
B167	150-027	Neon, NE-23	

CAPACITORS

Tolerance $\pm 20\%$ unless otherwise indicated.

C9	281-523	100 pf	Cer.	350 v	
C10	283-002	.01 μf	Disc Type	500 v	
C15	283-000	.001 μf	Disc Type	500 v	
C20	283-003	.01 μf	Disc Type	150 v	
C24	281-546	330 pf	Cer.	500 v	10%
C31	283-001	.005 μf	Disc Type	500 v	
C37	281-511	22 pf	Cer.	500 v	10%
C113	283-000	.001 μf	Disc Type	500 v	
C130	281-518	47 pf	Cer.	500 v	
C134	281-504	10 pf	Cer.	500 v	10%
C141	281-544	5.6 pf	Cer.	500 v	10%
C147	281-525	470 pf	Cer.	500 v	
C160A	281-007	3-12 pf	Cer.	Var.	
C160B	281-528	82 pf	Cer.	500 v	10%
C160C	281-010	4.5-25 pf	Cer.	Var.	
C160D	*291-008	.001 μf	Timing Series		$\pm 1/2\%$
C160E	*291-029	.01 μf			$\pm 1/2\%$
C160F		.1 μf			
C160G		1 μf			
C165		281-523	100 pf	Cer.	350 v
C167	283-000	.001 μf	Disc Type	500 v	
C320	281-509	15 pf	Cer.	500 v	10%
C321	281-010	4.5-25 pf	Cer.	Var.	
C334	281-510	22 pf	Cer.	500 v	
C341	281-010	4.5-25 pf	Cer.	Var.	
C348	281-534	3.3 pf	Cer.	500 v	$\pm .25$ pf
C356	283-003	.01 μf	Disc Type	150 v	
C361	283-002	.01 μf	Disc Type	500 v	
C397	283-008	.1 μf	Disc Type	500 v	

DIODES

D124	152-008	Germanium T12G
D126	*152-061	Silicon Tek Spec
D130	152-008	Germanium T12G

RESISTORS

Ckt. No.	Tektronix Part No.		Description		S/N Range
Resistors are fixed, composition, $\pm 10\%$ unless otherwise indicated.					
R14	302-105	1 meg	$\frac{1}{2}$ w		
R15	302-474	470 k	$\frac{1}{2}$ w		
R16	301-303	30 k	$\frac{1}{2}$ w		5%
R17	311-206	250 k		Var.	LEVEL
R19	301-105	1 meg	$\frac{1}{2}$ w		5%
R20	301-304	300 k	$\frac{1}{2}$ w		5%
R22	302-151	150 Ω	$\frac{1}{2}$ w		
R23	302-151	150 Ω	$\frac{1}{2}$ w		
R24	301-512	5.1 k	$\frac{1}{2}$ w		5%
R25	301-512	5.1 k	$\frac{1}{2}$ w		5%
R28	303-223	22 k	1 w		5%
R30	302-224	220 k	$\frac{1}{2}$ w		
R31	302-224	220 k	$\frac{1}{2}$ w		
R32	302-101	100 Ω	$\frac{1}{2}$ w		
R34	302-122	1.2 k	$\frac{1}{2}$ w		
R35	302-272	2.7 k	$\frac{1}{2}$ w		
R37	309-139	333 k	$\frac{1}{2}$ w	Prec.	1%
R38	309-056	390 k	$\frac{1}{2}$ w	Prec.	1%
R40	302-225	2.2 meg	$\frac{1}{2}$ w		
R41	302-101	100 Ω	$\frac{1}{2}$ w		
R43	302-472	4.7 k	$\frac{1}{2}$ w		
R46	304-273	27 k	1 w		
R111	311-112	15 k		Var.	STABILITY
R112	Use 301-123	12 k	$\frac{1}{2}$ w		5%
R113	301-183	18 k	$\frac{1}{2}$ w		5%
R123	301-274	270 k	$\frac{1}{2}$ w		5%
R124	302-473	47 k	$\frac{1}{2}$ w		
R126	Use 302-684	680 k	$\frac{1}{2}$ w		
R130	302-472	4.7 k	$\frac{1}{2}$ w		
R131	309-101	100 Ω	$\frac{1}{2}$ w		
R134	309-263	13.5 k	$\frac{1}{2}$ w	Prec.	1%
R135	309-263	13.5 k	$\frac{1}{2}$ w	Prec.	1%
R137	302-101	100 Ω	$\frac{1}{2}$ w		
R138	302-272	2.7 k	$\frac{1}{2}$ w		
R141	310-070	33 k	1 w	Prec.	1%
R143	309-231	16.69 k	$\frac{1}{2}$ w	Prec.	1%
R144	Use 324-296	11.8 k	1 w	Prec.	1%
R146	302-101	100 Ω	$\frac{1}{2}$ w		
R147	302-152	1.5 k	$\frac{1}{2}$ w		
R149	302-822	8.2 k	$\frac{1}{2}$ w		
R160A	309-007	666.6 k	$\frac{1}{2}$ w	Prec.	1%
R160B	309-007	666.6 k	$\frac{1}{2}$ w	Prec.	1%
R160C	309-023	2 meg	$\frac{1}{2}$ w	Prec.	1%
R160D	309-351	6.67 meg	$\frac{1}{2}$ w	Prec.	1%
R160F	309-351	6.67 meg	$\frac{1}{2}$ w	Prec.	1%
R160H	310-583	20 meg	2 w	Prec.	1%
R160W	316-104	100 k	$\frac{1}{4}$ w		
R160X	302-103	10 k	$\frac{1}{2}$ w		
R160Y†	311-166	20 k		Var.	VARIABLE
R161	302-101	100 Ω	$\frac{1}{2}$ w		

†Concentric with SW341. Furnished as a unit.

Parts List—Type 2B67

RESISTORS (Cont'd.)

Ckt. No.	Tektronix Part No.	Description	S/N Range
R165	302-683	68 k $\frac{1}{2}$ w	
R166	302-683	68 k $\frac{1}{2}$ w	
R167	302-105	1 meg $\frac{1}{2}$ w	
R168	302-473	47 k $\frac{1}{2}$ w	
R174	303-273	27 k 1 w	5%
R176	311-117	5 k	Var. SWP LENGTH
R178	301-113	11 k $\frac{1}{2}$ w	5%
R181	302-475	4.7 meg $\frac{1}{2}$ w	
R320	309-019	1.75 meg $\frac{1}{2}$ w	Prec. 1%
R321	309-016	1.23 meg $\frac{1}{2}$ w	Prec. 1%
R323	311-111	2 x 50 k	Var. POSITION
R324	303-203	20 k 1 w	5%
R326	301-244	240 k $\frac{1}{2}$ w	5%
R330	302-101	100 Ω $\frac{1}{2}$ w	
R332	304-183	18 k 1 w	
R333	301-103	10 k $\frac{1}{2}$ w	5%
R334	311-191	10 k	Var. CALIBRATION
R336	302-101	100 Ω $\frac{1}{2}$ w	
R338	302-393	39 k $\frac{1}{2}$ w	
R341	311-173	100 k	Var. SWP GAIN
R342	309-043	82 k $\frac{1}{2}$ w	Prec. 1%
R344	309-279	180 k $\frac{1}{2}$ w	Prec. 1%
R345	302-473	47 k $\frac{1}{2}$ w	
R346	311-125	50 k $\frac{1}{2}$ w	Var. SWP. MAG. REGIS.
R348	309-126	400 k $\frac{1}{2}$ w	Prec. 1%
R350	302-101	100 Ω $\frac{1}{2}$ w	
R352	302-393	39 k $\frac{1}{2}$ w	
R355	301-155	1.5 meg $\frac{1}{2}$ w	5%
R356	301-124	120 k $\frac{1}{2}$ w	5%
R357	302-101	100 Ω $\frac{1}{2}$ w	
R359	302-393	39 k $\frac{1}{2}$ w	
R360	302-105	1 meg $\frac{1}{2}$ w	
R361	302-474	470 k $\frac{1}{2}$ w	
R370	302-101	100 Ω $\frac{1}{2}$ w	
R371	302-101	100 Ω $\frac{1}{2}$ w	
R373	308-105	30 k 8 v	WW 5%
R375	305-153	15 k 2 v	5%
R377	308-191	35 k 8 v	WW 5%
R390	301-151	150 Ω $\frac{1}{2}$ v	5%
R391	301-151	150 Ω $\frac{1}{2}$ v	5%
R392	*308-141	1 Ω $\frac{1}{2}$ v	WW 5%
R397	302-470	47 Ω $\frac{1}{2}$ v	X10810-up

SWITCHES

Unwired	Wired	
SW5	260-450	Slide TRIGGERING SOURCE
SW10	260-448	Slide TRIGGERING COUPLING
SW17	260-353 *262-372	Rotary LEVEL
SW20	260-447	Slide TRIGGERING SLOPE
SW124	260-501	Lever MODE

Switches (Cont'd.)

Ckt. No.	Tektronix Part No.		Description	S/N Range
	Unwired	Wired		
SW160A } SW160B }	260-352	*262-371	Rotary TIME/DIV. CALIBRATED 5X MAG.	
SW341†	311-166			

TRANSISTORS

Q124	151-093	2N2043
------	---------	--------

ELECTRON TUBES

V24	154-187	6DJ8	
V45	154-187	6DJ8	
V135	154-187	6DJ8	
V145	154-278	6BL8	
V152	154-232	6BC7	5001-10809
V152	154-453	6BJ7	10810-up
V161	154-278	6BL8	
V333	154-187	6DJ8	
V353	154-187	6DJ8	
V374	154-187	6DJ8	

†Concentric with R160Y. Furnished as a unit.

TRIGGER
INPUT AMPLIFIER

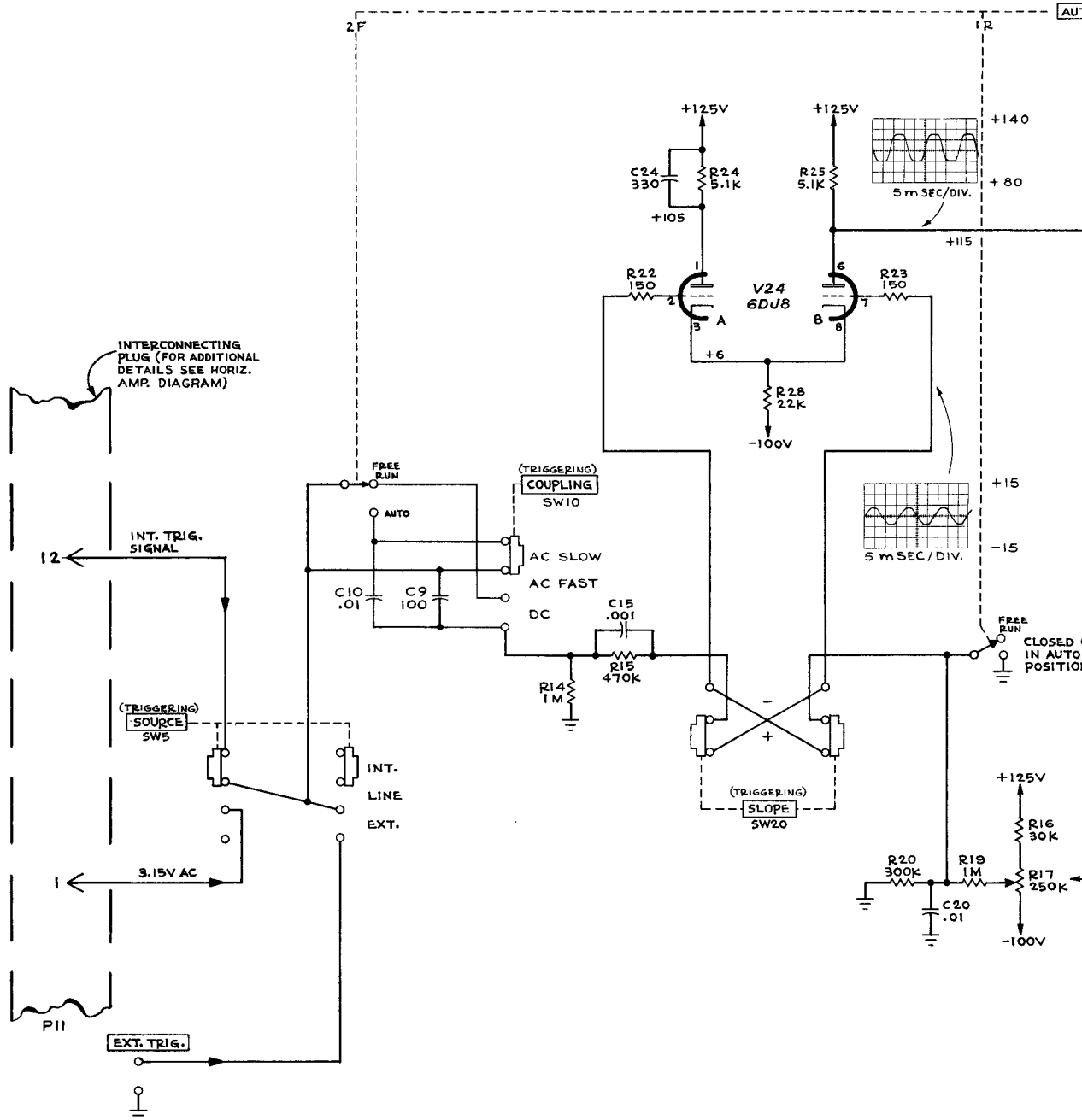

TYPE 2B67 PLUG-IN UNIT

A

+

TRIGGER MULTIVIBRATOR

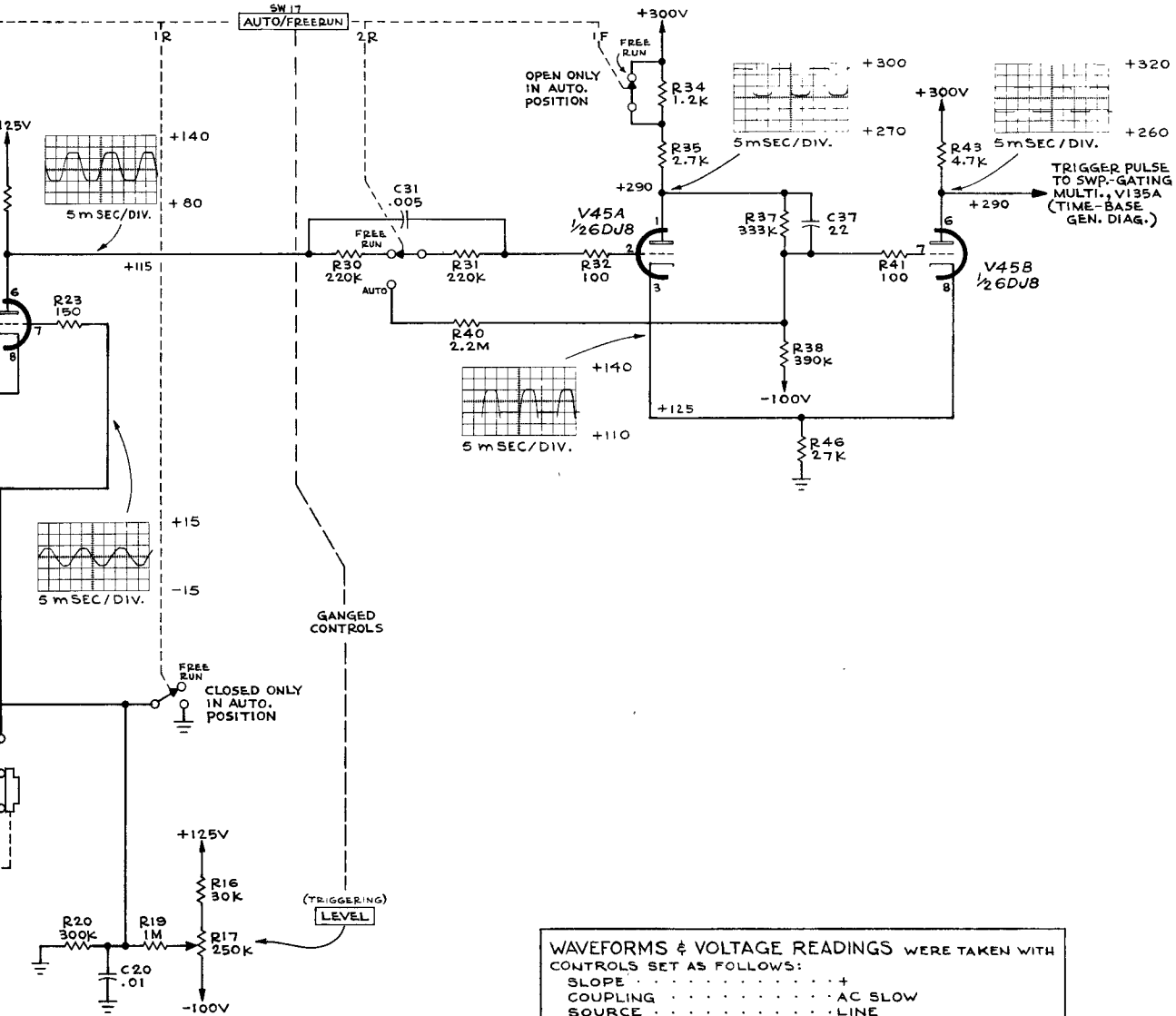

WAVEFORMS & VOLTAGE READINGS WERE TAKEN WITH CONTROLS SET AS FOLLOWS:

- SLOPE +
- COUPLING AC SLOW
- SOURCE LINE
- LEVEL MIDRANGE
- TIME/DIV.
- WAVEFORMS 1mSEC
- VOLTAGES EXT. INPUT
- VARIABLE CALIBRATED & PUSHED IN (5X MAG. OFF)

POSITION

- FOR WAVEFORMS MIDRANGE
- FOR VOLTAGE READINGS SET FOR EQUAL VOLTAGES AT PLATES OF V374
- MODE NORMAL

SINGLE SWEEP
LOCKOUT

SWEEP-GATING
MULTIVIBRATOR

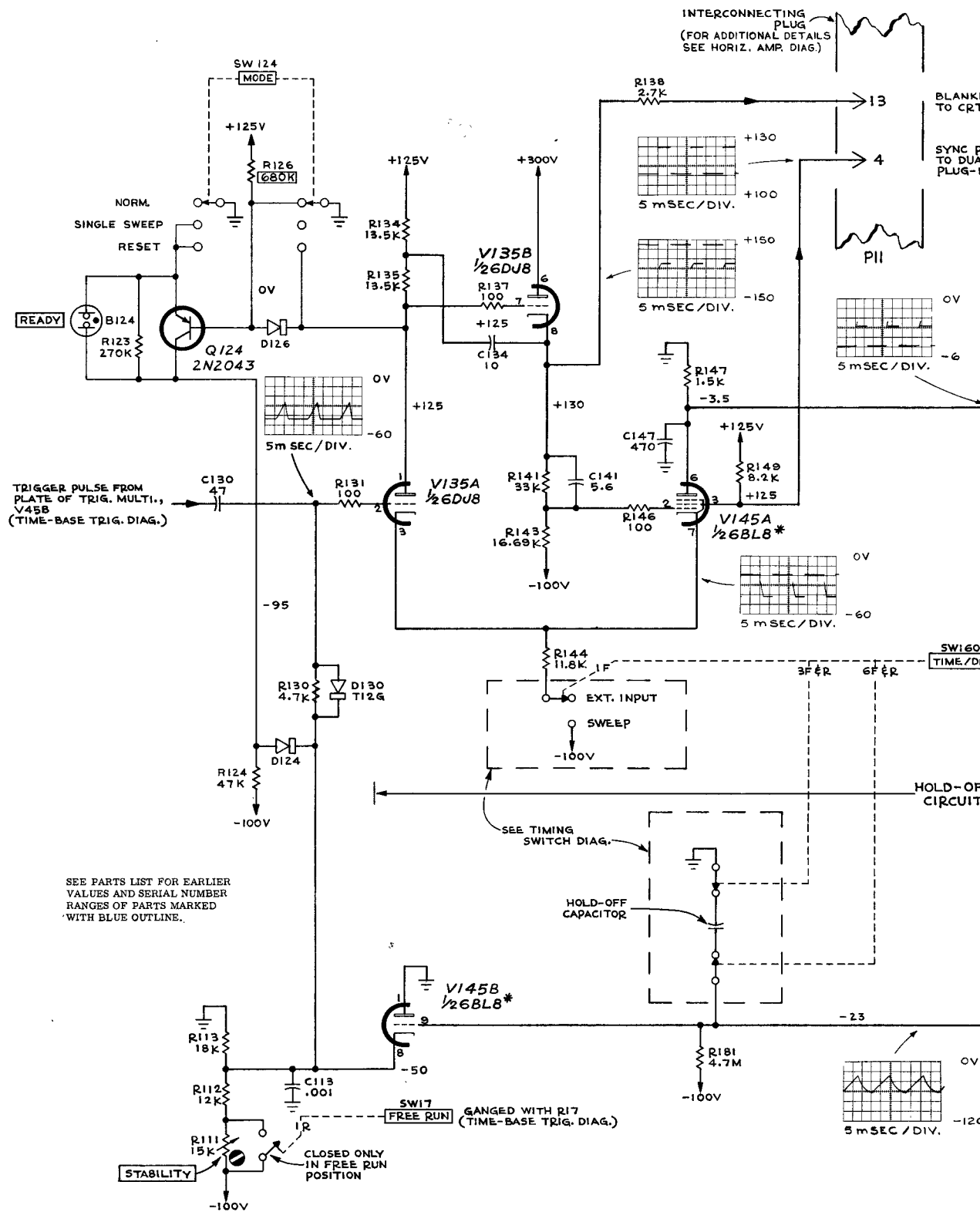

DISCONNECT
DIODES

MILLER RUNUP
CIRCUIT

+

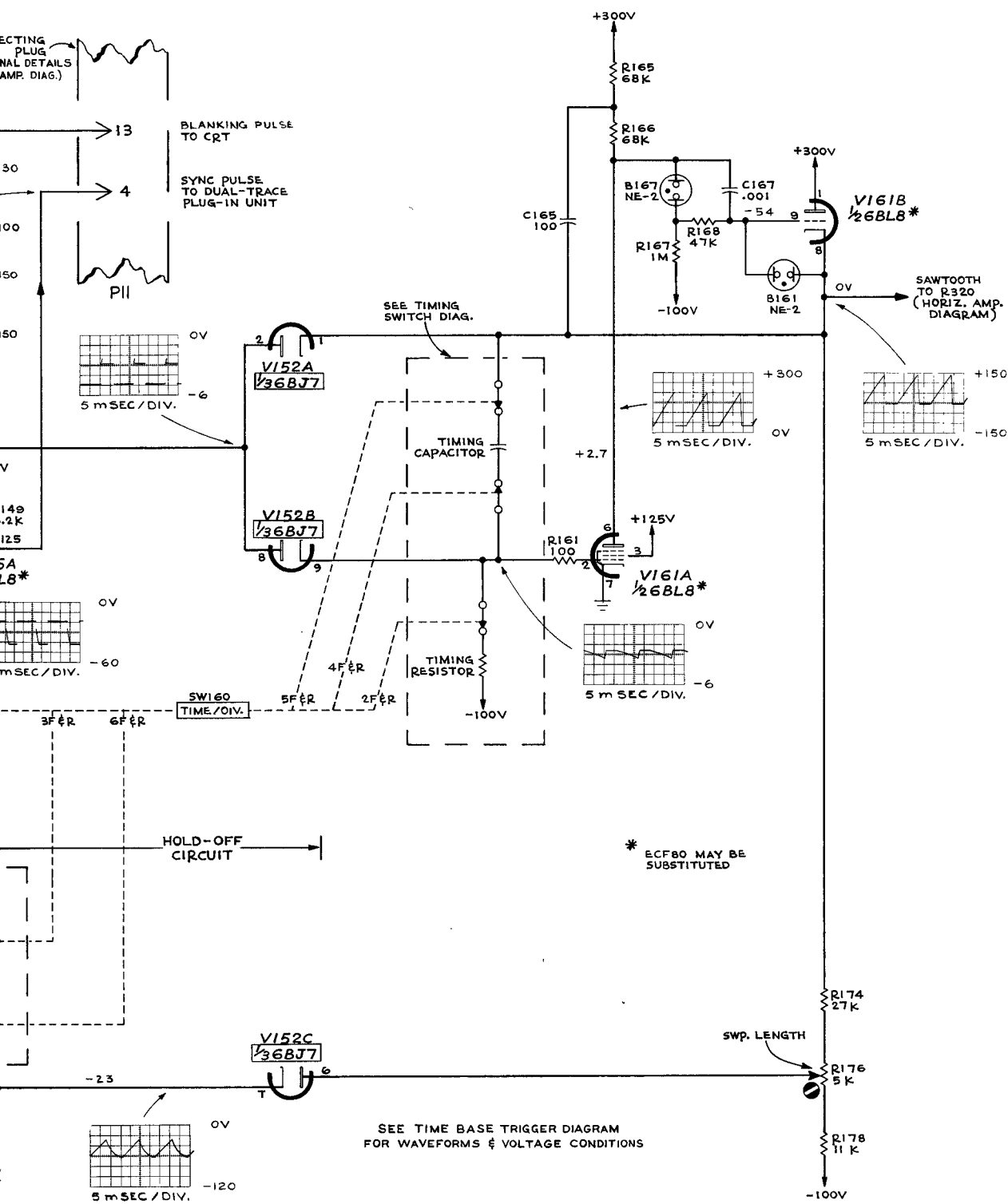

TR
764

TIME-BASE GENERATOR

B

TIME-BASE GENERATOR DIAGRAM

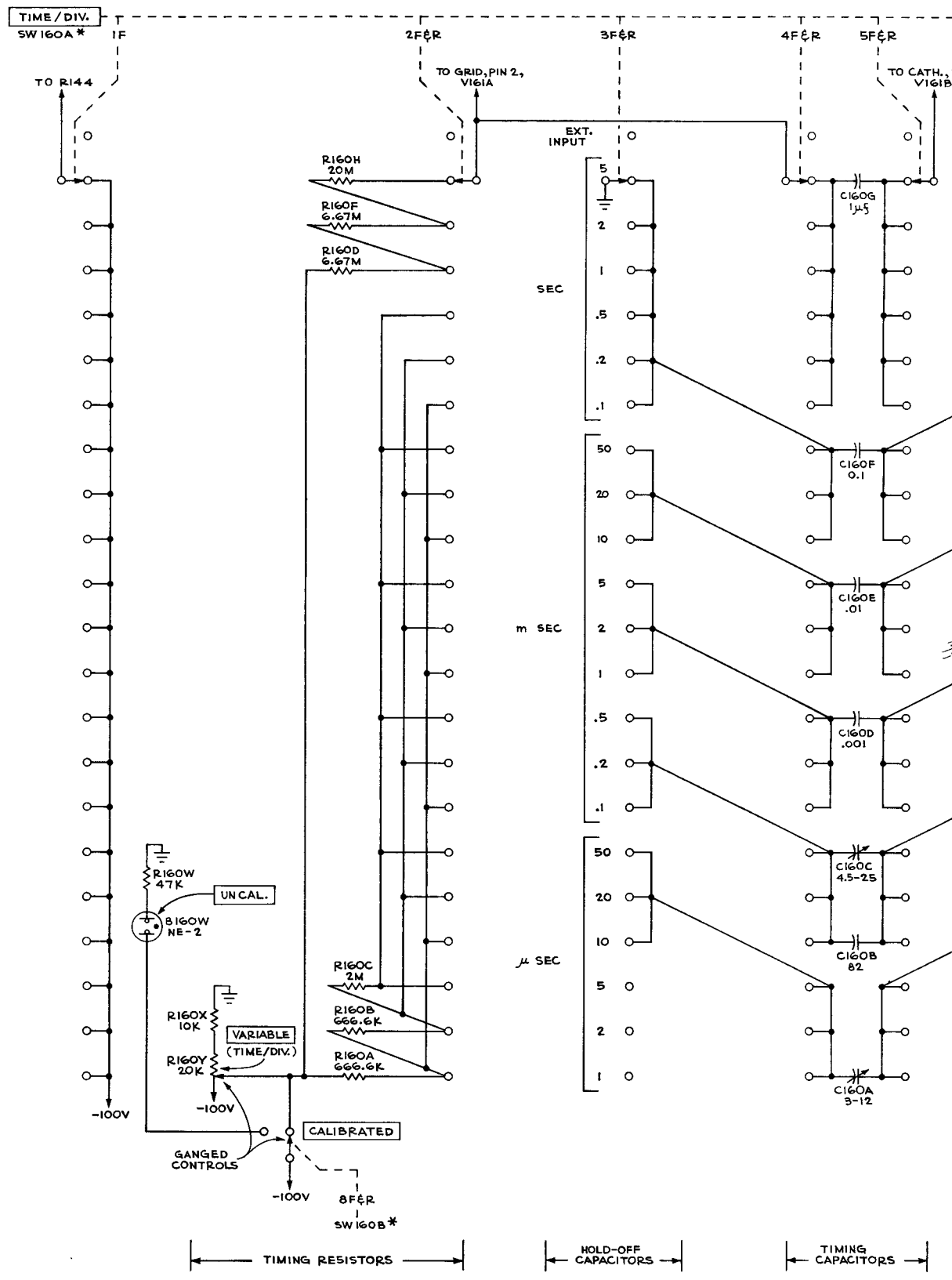

TYPE 2B67 PLUG-IN UNIT

HORIZONTAL AMPLIFIER DIAGRAM

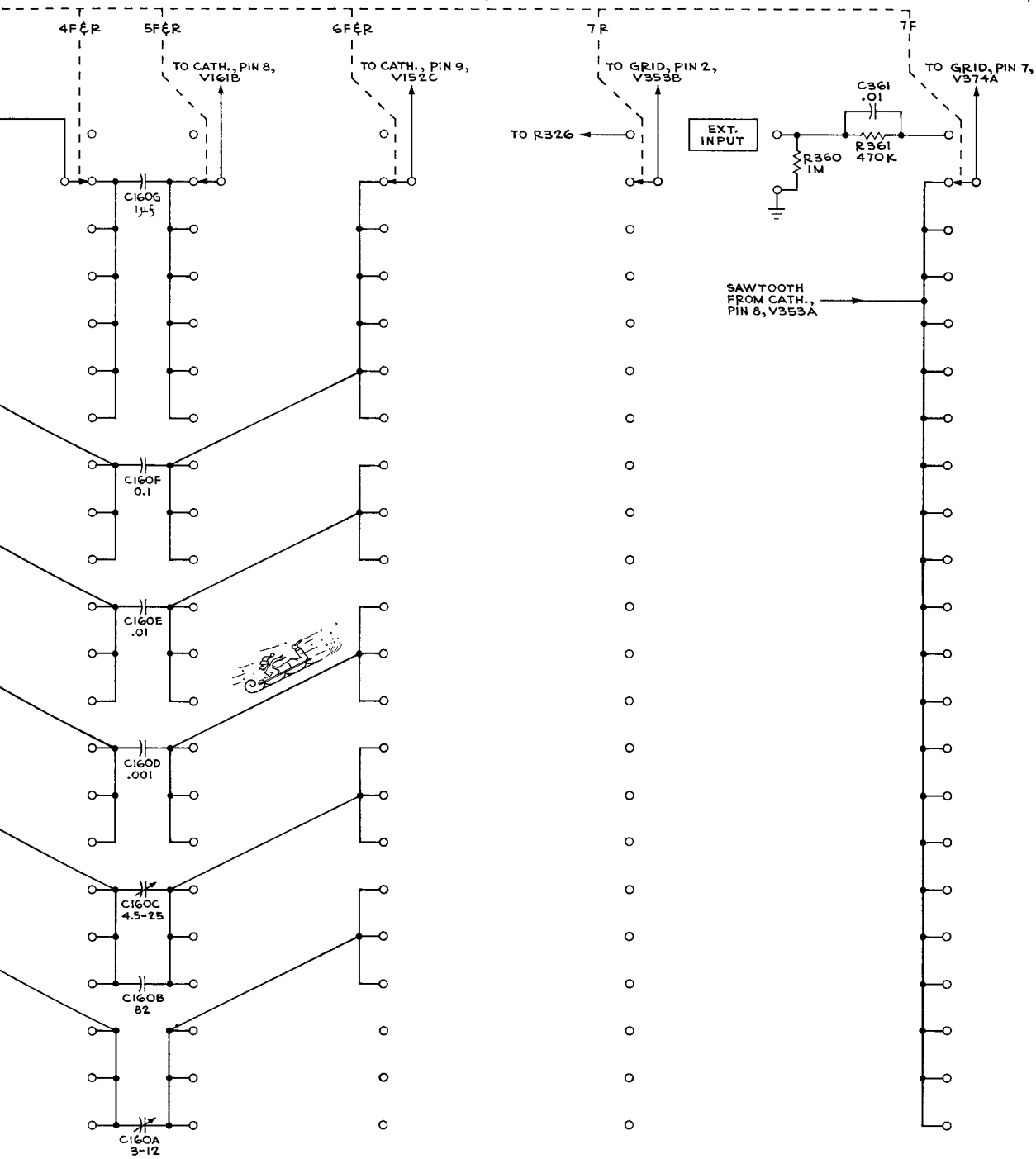

TIMING CAPACITORS

HOLD-OFF CAPACITORS

GAB
363

TIMING SWITCH

A

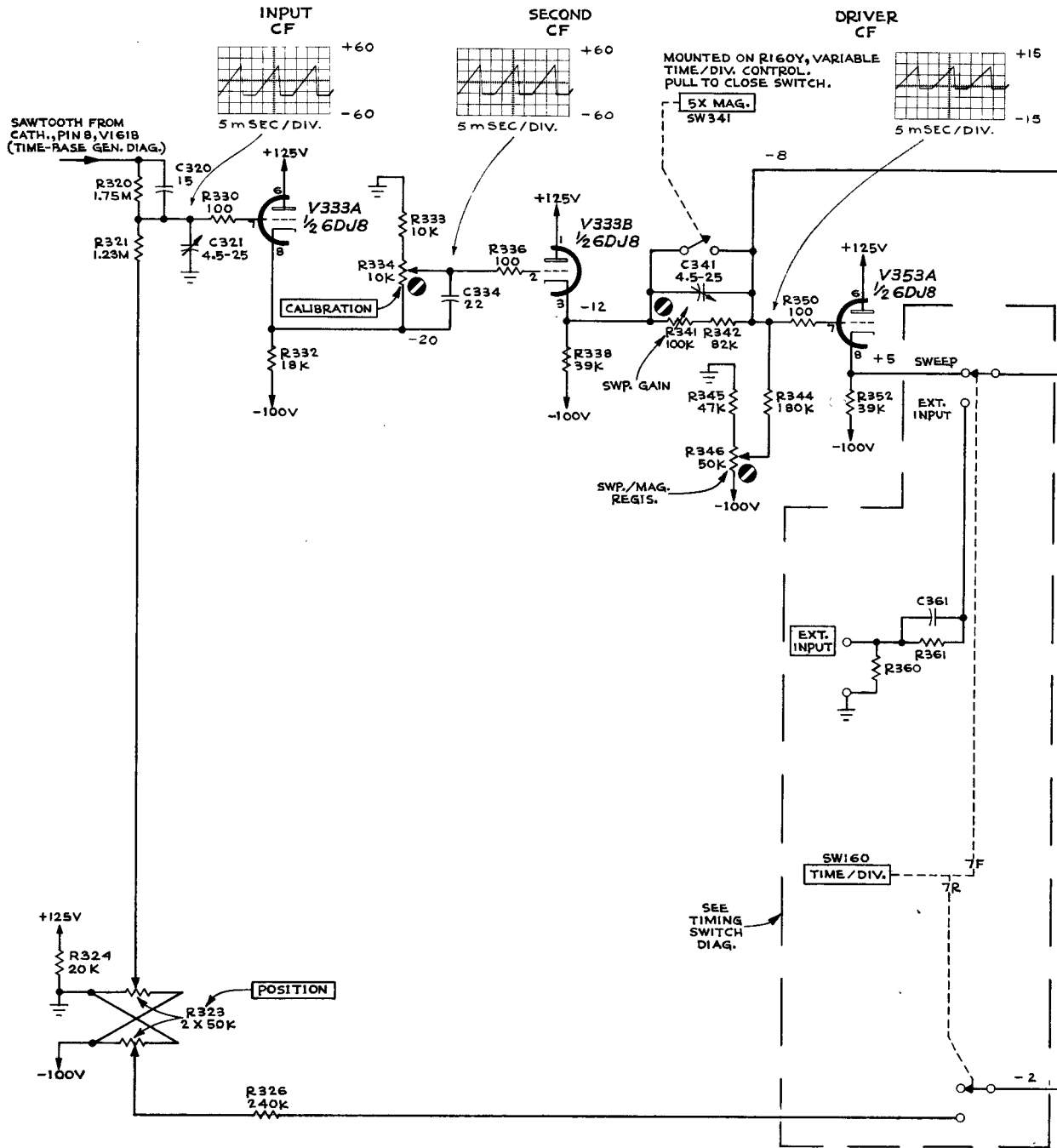

RESISTANCE READINGS TAKEN WITH PLUG-IN REMOVED FROM OSCILLOSCOPE

SEE TIME BASE TRIGGER DIAGRAM FOR WAVEFORMS & VOLTAGE CONDITIONS

SEE PARTS LIST FOR VALUES AND SIZES. RANGES OF PARTS VALUES WITH BLUE OUTFITTING

TYPE 2B67 PLUG-IN UNIT

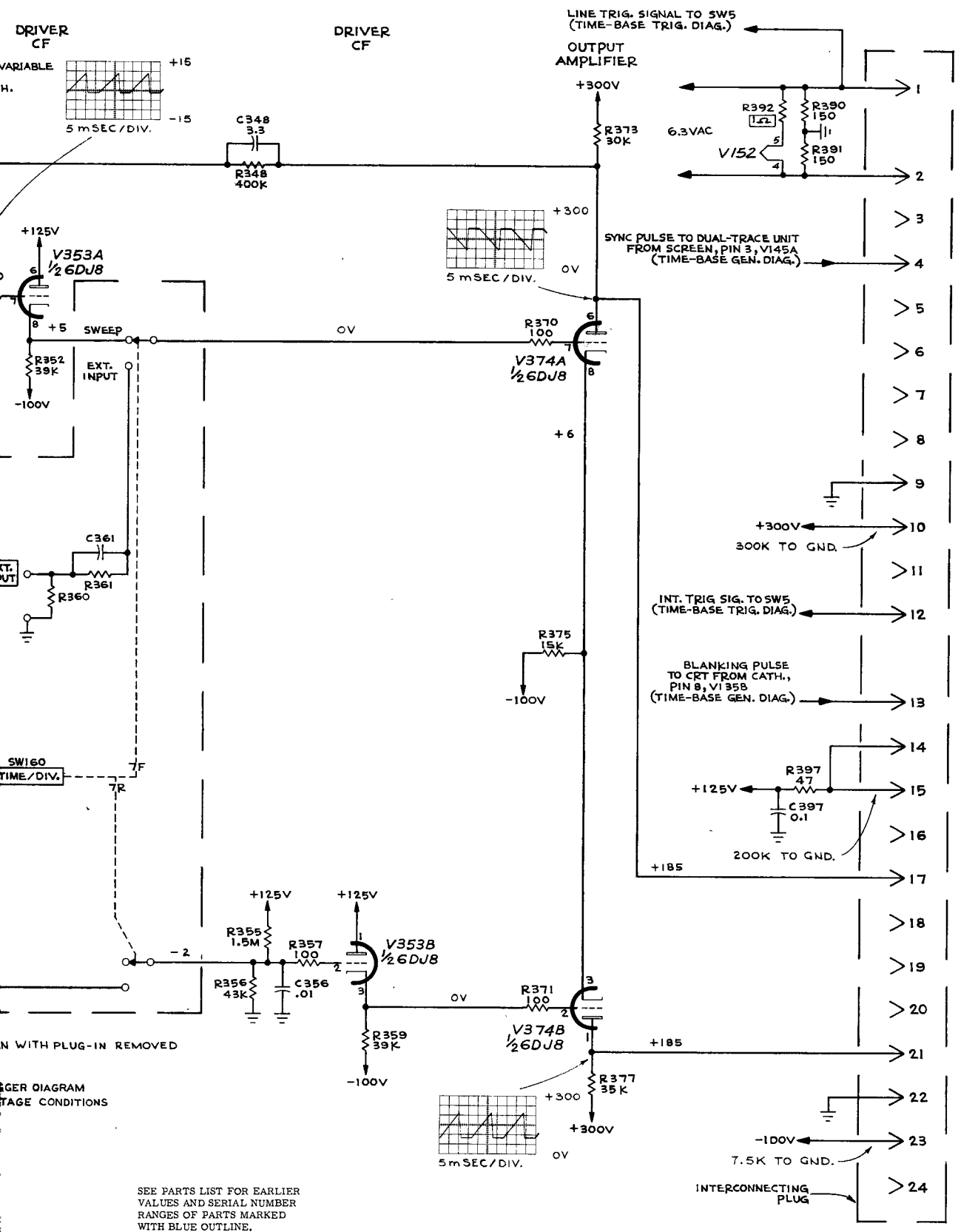

SEE PARTS LIST FOR EARLIER VALUES AND SERIAL NUMBER RANGES OF PARTS MARKED WITH BLUE OUTLINE.

MANUAL CHANGE INFORMATION

At Tektronix, we continually strive to keep up with latest electronic developments by adding circuit and component improvements to our instruments as soon as they are developed and tested.

Sometimes, due to printing and shipping requirements, we can't get these changes immediately into printed manuals. Hence, your manual may contain new change information on following pages. If it does not, your manual is correct as printed.