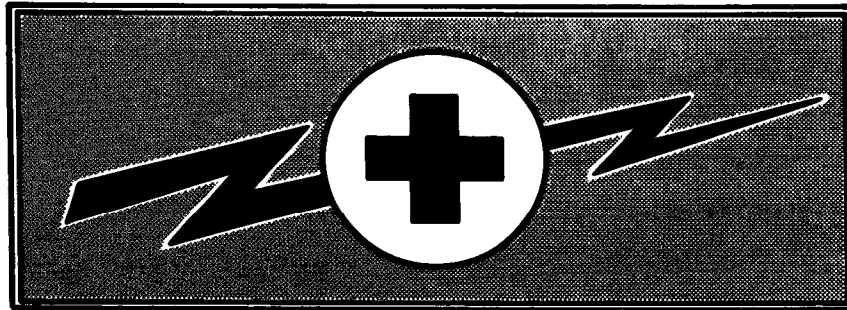

TECHNICAL MANUAL

**OPERATOR, ORGANIZATIONAL,
DIRECT SUPPORT, AND GENERAL SUPPORT
MAINTENANCE MANUAL
(INCLUDING REPAIR PARTS)
FOR**

**UNIVERSAL COUNTER/TIMER,
TEKTRONIX, MODEL DC 503A
(NSN 6625-01-114-4890)**

WARNING

RA PD 404264

DANGEROUS VOLTAGE

is used in the operation of this equipment

DEATH ON CONTACT

may result if personnel fail to observe safety precautions

Never work on electronic equipment unless there is another person nearby who is familiar with the operation and hazards of the equipment and who is competent in administering first aid. When the technician is aided by operators, he must warn them about dangerous areas.

Whenever possible, the power supply to the equipment must be shut off before beginning work on the equipment. Take particular care to ground every capacitor likely to hold a dangerous potential. When working inside the equipment, after the power has been turned off, always ground every part before touching it.

Be careful not to contact high-voltage connections when installing or operating this equipment.

Whenever the nature of the operation permits, keep one hand away from the equipment to reduce the hazard of current flowing through vital organs of the body.

WARNING

Do not be misled by the term "low voltage." Potentials as low as 50 volts may cause death under adverse conditions.

COMMON and probe ground straps are electrically connected. Herefore, an elevated reference applied to any is present on each - as indicated by the yellow warning bands under the probe retractable hook tips.

For Artificial Respiration, refer to FM 21-11,

Power Source

This product is intended to operate in a power module connected to a power source that will not apply more than 250 volts rms between the supply conductors or between either supply conductor and ground. A protective ground connection by way of the grounding conductor in the power cord is essential for safe operation.

Copyright 1980 Tektronix, Inc. All rights reserved.
 Reproduced by permission of copyright owner.

TECHNICAL MANUAL)
)
 No. 9-6625-474-14&P-3)

HEADQUARTERS
 DEPARTMENT OF THE ARMY
 Washington, D. C., 26 December 1984

**OPERATOR, ORGANIZATIONAL, DIRECT SUPPORT,
 AND GENERAL SUPPORT MAINTENANCE MANUAL
 (INCLUDING REPAIR PARTS)
 FOR
 UNIVERSAL COUNTER/TIMER,
 TEKTRONIX, MODEL DC 503A
 (NSN 6625-01-114-4890)**

REPORTING OF ERRORS

You can help improve this manual. If you find any mistakes or if you know of a way to improve the procedures, please let us know. Mail your letter or DA Form 2028 (Recommended Changes to Publications and Blank Forms), direct to: Commander, US Army Missile Command, ATTN: DRSMI-SNPM, Redstone Arsenal, AL 35898-5238. A reply will be furnished to you.

TABLE OF CONTENTS

	Page
LIST OF ILLUSTRATIONS	iii
LIST OF TABLES	IV
SECTION 0	
GENERAL INFORMATION	0-1
Scope	0-1
indexes of Publications	0-1
Forms, Records, and Reports	0-1
Reporting Equipment Improvement Recommendations (EIRs)	0-1
Administrative Storage	0-1
Destruction of Army Electronics Materiel	0-1
SECTION 1.	1-1
SECTION 2.	
OPERATING INSTRUCTIONS	2-1
Introduction	2-1
Controls and Connectors	2-2
Operating Considerations	2-4
Input Considerations	2-4
Operators Familiarization	2-5
Operating Modes	2-7
SECTION 3.	3-1
SECTION 4.	
CALIBRATION	4-1
Performance Check Procedure	4-1
Adjustment Procedure	4-8
SECTION 5.	5-1
MAINTENANCE	

This manual is, in part, authenticated manufacturer's commercial literature. Recommended Spare Parts List has been added to supplement the commercial literature. The format of this manual has not been structured to consider levels of maintenance.

TABLE OF CONTENTS (CONT)

		Page
SECTION 6.	OPTIONS	6-1
SECTION 7.	REPLACEABLE ELECTRICAL PARTS	7-1
SECTION 8.	DIAGRAMS AND CIRCUIT BOARD ILLUSTRATIONS	8-1
SECTION 9.	REPLACEABLE MECHANICAL PARTS	9-1
APPENDIX A.	REFERENCES	A-1
APPENDIX B.	MAINTENANCE ALLOCATION CHART (MAC)	B-1
APPENDIX C.	RECOMMENDED SPARE PARTS LIST	C-1
APPENDIX D.	MANUAL CHANGE INFORMATION	D-1

LIST OF ILLUSTRATIONS

Fig. No.	Title	Page
0-1	DC 503A Universal Counter/Timer	0-2
2-1	Plug-In Installation/Removal	2-1
2-2	Controls and Connectors	2-3
2-3	Triggering Circuit Response to Improper (A) and Proper (B) Level Settings	2-5
2-4	Representation of Interval Measurements	2-9
2-5	Typical CHA and CH B Level out Voltage Settings for Various Time interval Measurements	2-10
2-6	Illustration of CH A Events Counted from Portion of CH A Signal Pulses during the Counter Gate Open Time (Controlled by the CH B Signal)	2-11
3-1	Typical DC 503A Timing Diagram	3-5
4-1	Check Set-Up for the High Frequency Sensitivity Using X1 and X5 Attenuation	4-4
4-2	Check Set-Up for Low Frequency ac and dc Sensitivity	4-6
4-3	Check Set-Up for Minimum Pulse Width Signals	4-8
4-4	Check Set-Up for Trigger Level Range (3.5V) and Accuracy ($\pm 20\text{mV} \pm 0.5\%$ of Reading)	4-12
5-1	Typical Square Pin Assembly	5-3
5-2	Exploded View of Circuit Board Pin and Ferrule	5-3
5-3	Dual Entry Circuit Board Pin Socket	5-4
5-4	Bottom Entry Circuit Board Pin Socket	5-4
5-5	Orientation and Disassembly of Multipin Connectors	5-4
5-6	Rear Frame Removal	5-5
5-7	Circuit Board Removal	5-5
5-8	Pushbutton Switch Removal	5-5
5-9	Rear Interface Connector Assignments	5-7
5-10	Rear Interface Timing for a Display of 1079.0674	5-8

LIST OF TABLES

Table No.	Title	Page
1-1	Electrical Characteristics	1-2
1-2	Miscellaneous	1-7
1-3	Environmental	1-7
1-4	Physical Characteristics	1-8
2-1	Frequency A Display Check	2-5
2-2	Period B, Time A-B, Width B (Timing Mode) Display Check	2-6
2-3	Period B, Time A- B, Width B (Averaging Mode) Display Check	2-6
2-4	Ratio A/B and Events A During B Display Check	2-6
2-5	Gate Time vs Measurement Resolution	2-8
3-1	PROM Selection Code	3-10
4-1	List of Test Equipment Requirements	4-2
5-1	Relative Susceptibility to Static Discharge Damage	5-1

SECTION 0

GENERAL INFORMATION

0-1. Scope. This manual contains instructions for the operator, organizational, direct support, and general support maintenance of and calibration procedures for Tektronix Universal Counter/Timer, Model DC 503A. Throughout this manual, Tektronix Universal Counter/Timer, Model DC 503A is referred to as the DC 503A.

0-2. Indexes of publications. *a. DA Pam 310-4.* Refer to the latest issue of DA Pam 310-4 to determine whether there are new editions, changes, or additional publications pertaining to Tektronix Universal Counter/Timer, Model DC 503A.

b. DA Pam 310-7. Refer to the latest issue of DA Pam 310-7 to determine whether there are modification work orders (MWO'S) pertaining to Tektronix Universal Counter/Timer, Model DC 503A.

0-3. Forms, Records, and Reports. Department of Army forms and procedures used for equipment maintenance and calibration are those prescribed by TM 38-750, The Army Maintenance Management System. Accidents involving injury to personnel or damage to materiel will be reported on DA Form 285, Accident Report, in accordance with AR 385-40.

0-4. Reporting Equipment Improvement Recommendations (EIR). If your DC 503A needs improvement, let us know. Send us an EIR. You, the user, are the only one who can tell us what you don't like about your equipment. Let us know why you don't like the design. Tell us why a procedure is hard to perform. Put it on an SF 368 (Quality Deficiency Report). Mail it to Commander, U.S. Army Missile Command, ATTN: DRSMI-QMD, Redstone Arsenal, AL 35898-5290. We'll send you a reply.

0-5. Administrative Storage. To prepare the Tektronix Universal Counter/Timer, Model DC 503A for placement into and removal from administrative storage, refer to Section 3, Chapter 4, AR 750-25-1, Maintenance of Equipment and Supplies. Temporary storage should be accomplished in accordance with TB 750-25-1, Section 2, Maintenance of Supplies and Equipment.

0-6. Destruction of Army Electronics Materiel. Destruction of Tektronix Universal Counter/Timer, Model DC 503A to prevent enemy use shall be in accordance with TM 750-244-2.

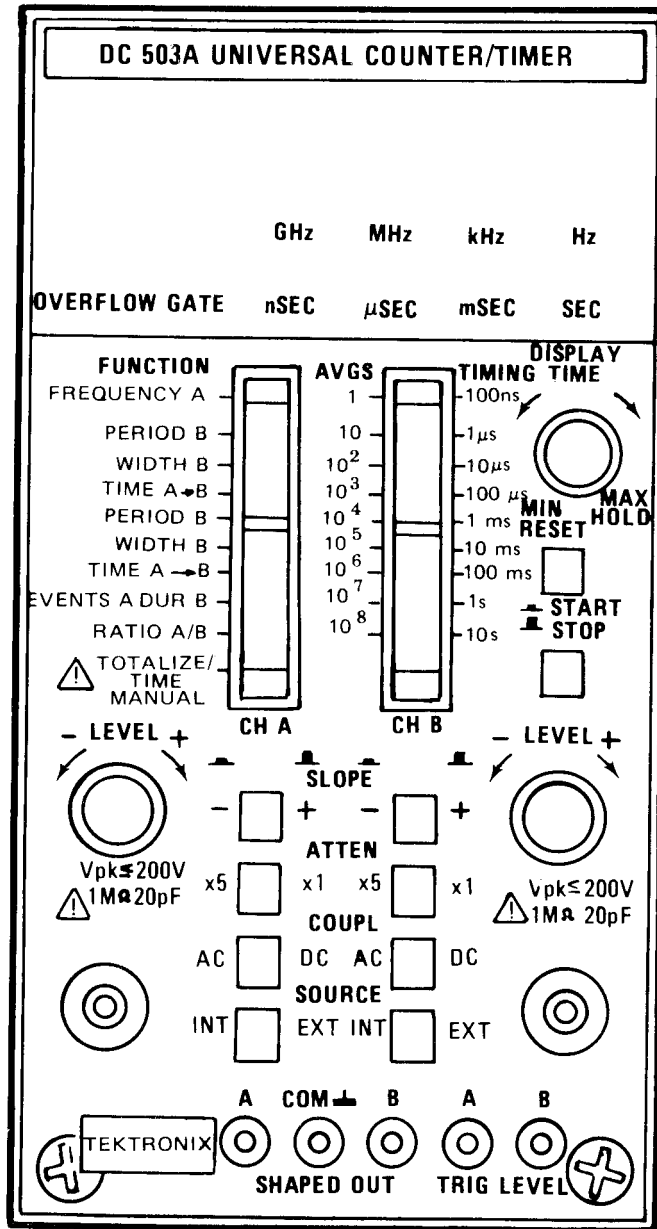

Fig. 0-1. DC 503A Universal Counter/Timer

SECTION 1

SPECIFICATION**Instrument Description**

The DC 503A Universal Counter/Timer is designed to operate in a TM 500-series power module.

The instrument has two input channels, CH A and CH B, each with 125 MHz capability. Each channel has separate triggering level, triggering slope, attenuator, and coupling mode controls.

The DC 503A has eight measurement functions: FREQUENCY A, PERIOD B, WIDTH B, TIME A - B, RATIO A/B, EVENTS A DURING B, TOTALIZE A, and TIME MANUAL. All of the modes except FREQUENCY A, TOTALIZE A, and TIME MANUAL have the capability of averaging the selected measurement over a range of 1 to 10^8 times the input signal. The signals to be counted or measured can be applied via front panel bnc connectors or through the rear interface.

The triggering level for each channel can be monitored via the front panel or the rear interface connections. The buffered voltage available at these connectors corresponds to the trigger levels set by the front panel controls.

The output of the internal signal shaping circuits can also be monitored via front panel connectors. These shaped signal outputs are useful in setting the triggering points on complex waveforms.

Measurement results are displayed in an eight digit LED readout. The decimal point is automatically positioned and leading zeros are blanked. Single annunciators (LEDs) are used to indicate register overflow, active gating interval, and the frequency or time units associated with the measurement being made.

The DC 503A can be equipped with an optional, oven controlled, 10 MHz crystal oscillator to obtain a highly stable and precise internal time base. Both the optional oscillator and the standard 10 MHz time bases provide 100 ns single shot resolution.

Instrument Options

Option 01 replaces the internal 10 MHz time base (clock) circuit with a self-contained proportional temperature controlled oven oscillator for increased accuracy and stability.

Standard Accessories

- 1 Instruction Manual
- 1 Cable assembly, bnc-to-tip jack.

NOTE

Refer to the tabbed Accessories page at the rear of this manual for more information.

Performance Conditions

The limits stated in the Performance Requirements columns of the following tables are valid only if the DC 503A has been calibrated at an ambient temperature between +20°C and +30°C and is operating at an ambient temperature between 0°C and +50° unless otherwise stated.

Information given in the Supplemental Information and Description columns of the following tables is provided for user information only and should not be interpreted as Performance Check requirements.

The DC 503A must be operated or stored in an environment whose limits are described under Environmental Characteristics.

Allow at least 20 minutes warm-up time for operation to specified accuracy, 60 minutes after storage in a high humidity environment.

Table 1-1
ELECTRICAL CHARACTERISTICS

Characteristics	Performance Requirements	Supplemental Information
CH A and CH B INPUTS/OUTPUTS		
Input Frequency Range		
Front Panel		
DC Coupled	0 Hz to ≥ 125 MHz.	
AC Coupled	10 Hz to ≥ 125 MHz.	
Rear Interface		
DC Coupled	0 Hz to ≥ 50 MHz.	
AC Coupled	10 Hz to ≥ 50 MHz.	
Input Sensitivity		
X1 Attenuation	20 mV rms sine wave to 100 MHz.	
	35 mV rms sine wave to 125 MHz.	
	60 mV peak-to-peak pulse at a minimum pulse width of 5 ns to 100 MHz.	
	100 mV peak-to-peak pulse at a minimum pulse width of 4 ns to 125 MHz.	
X5 Attenuation Accuracy		$\leq 2\%$ at dc.
Input Dynamic Range		
X1 Attenuation		≤ 3 V, peak-to-peak.
X5 Attenuation		≤ 15 V, peak-to-peak.
Shaped Outputs		
Delay From Front Panel		Typically 15 ns.
Output Voltage Levels		≥ 100 mV into 50Ω , ≥ 200 mV unterminated.
Trigger Level		
Range	± 3.5 V times attenuation	
Slope	Plus (+) or minus (-)	Independently selectable.
Output accuracy	± 20 mV $\pm 0.5\%$ of reading	
Input Impedance		
Front Panel		
X1, X5 Attenuation		1 M Ω , shunted by approximately 27 pF. (-13 V $\leq V_m \leq +6$ V).
Rear Interface		
X1, X5 Attenuation		Approximately 50 Ω at dc.

Table 1-1 (cont)

Characteristics	Performance Requirements	Supplemental Information
CH A and CH B INPUTS/OUTPUTS (cont)		
Maximum Safe Input Voltage		
Front Panel		
X1 Attenuation		
DC to 50 kHz		200 V peak, 400 V peak-to-peak.
50 kHz to 1.33 MHz		200 V peak, peak-to-peak voltage $\leq \frac{20}{f \text{ (MHz)}}$
1.33 MHz to 125 MHz		200 V peak, peak-to-peak voltage $\leq 15 \text{ V}$.
X5 Attenuation		
DC to 5 MHz		200 V peak, 400 V peak-to-peak.
5 MHz to 100 MHz		200 V peak, peak-to-peak voltage $\leq \frac{2000}{f \text{ (MHz)}}$
100 MHz to 125 MHz		200 V peak, peak-to-peak voltage $\leq 20 \text{ V}$.
Rear Interface		
X1, X5 Attenuation		$\leq 4 \text{ V, peak}$.
FUNCTIONS		
FREQUENCY A		
Range		
DC Coupled	DC to 125 MHz.	
AC Coupled	10 Hz to 125 MHz.	
Minimum Pulse Width	4 ns at 100 mV, peak-to-peak.	
Accuracy ^a		$\pm 1 \text{ count} \pm \text{time base error}$.
Gate Time (Resolution)		10 sec to 100 ns (0.1 Hz to 10 MHz), selected in decade steps.
PERIOD B (Single Shot)		
Repetition Rate	$\geq 125 \text{ MHz}$	
Minimum Pulse Width	4 ns at 100 mV, peak-to-peak.	
Accuracy ^{a c}		$\pm 1 \text{ count} \pm \text{time base error}$ $\pm 1.4 \text{ X CH B trigger error}$.
Resolution (Clock Rate)		10 sec to 100 ns (0.1 Hz to 10 MHz), selected in decade steps.
PERIOD B (Average)		
Repetition Rate	$\geq 125 \text{ MHz}$	
Minimum Pulse Width	4 ns at 100 mV, peak-to-peak.	

Table 1-1 (cont)

Characteristics	Performance Requirements	Supplemental Information
FUNCTIONS (cont)		
Accuracy ^{a b c}		$\pm 100 \text{ ns} \pm \text{time base error}$ N $\pm 1.4 \times \left(\frac{\text{CH B trigger error}}{N} \right)$
Clock Rate		100 ns (10 MHz), fixed.
Number of Averages (N)		10 ⁰ (1) to 10 ⁸ , selected in decade steps.
Resolution		1 femtosecond (10 ⁻¹⁵) to 100 ns, selected in decade steps.
WIDTH B (Single Shot)		
Minimum Pulse Width	20 ns.	
Accuracy ^{d e}		$\pm 1 \text{ count} \pm \text{CH B trigger error}$ (rising edge) $\pm \text{CH B trigger error}$ (falling edge) $\pm \text{time base error}$.
Resolution (Clock Rate)		10 sec to 100 ns (0.1 Hz to 10 MHz), selected in decade steps.
WIDTH B (Average)		
Minimum Pulse Width	5 ns.	
Repetition Rate	$\geq 100 \text{ MHz}$	
Minimum Dead Time		5 ns.
Clock Rate		100 ns (10 MHz), fixed.
Number of Averages (N)		10 ⁰ (1) to 10 ⁸ , selected in decade steps.
Resolution ^h		$\frac{100 \text{ ns}}{\sqrt{N}}$
Accuracy ^{d h i}		$\pm 100 \text{ ns} \pm \text{time base error}$ $\frac{\pm \text{CH B trigger error (rising edge)}}{\sqrt{N}}$ $\frac{\pm \text{CH B trigger error (falling edge)}}{\sqrt{N}}$
TIME A -- B (Single Shot)		
Minimum Time Interval	12.5 ns.	
Accuracy ^{d e}		$\pm 1 \text{ count} \pm \text{time base error}$ $\pm \text{CH A trigger error} \pm \text{CH B trigger error} \pm 4 \text{ ns}$.
Resolution (Clock Rate)		10 sec to 100 ns (0.1 Hz to 10 MHz), selected in decade steps.

Table 1-1 (cont)

Characteristics	Performance Requirements	Supplemental Information
FUNCTIONS (cont)		
TIME A → B (Average)		
Minimum Time Interval	12.5 ns.	
Minimum Dead Time		12.5 ns.
Number of Averages (N)		10 ⁰ (1) to 10 ⁸ , selected in decade steps.
Clock Rate		100 ns (10 MHz), fixed.
Resolution ^b		$\frac{100 \text{ ns}}{\sqrt{N}}$
Accuracy ^{a b c}		$\frac{\pm 100 \text{ ns} \pm \text{time base error}}{\sqrt{N}}$ $\frac{\pm \text{CH A trigger error}}{\sqrt{N}}$ $\frac{\pm \text{CH B trigger error}}{\sqrt{N}} \pm 4 \text{ ns.}$
EVENTS A DURING B (Average)		
Maximum CH A Frequency	≥125 MHz.	
Minimum CH B Pulse Width	5 ns	
Minimum Dead Time Between Pulses		5 ns.
Number of Averages (N)		10 ⁰ (1) to 10 ⁸ , selected in decade steps.
Accuracy ^{b c}		$\frac{\pm \text{Period A}}{\text{Width B} \times \sqrt{N}}$ $\frac{\pm \text{CH B trigger error (rising edge)} \times \text{Freq A}}{\sqrt{N}}$ $\frac{\pm \text{CH B trigger error (falling edge)} \times \text{Freq A}}{\sqrt{N}}$
RATIO A/B (Average)		
Frequency Range	≥125 MHz	Both channels.
Minimum Pulse Width	4 ns at 100 mV, peak-to-peak	Both channels.
Number of Averages (N)		10 ⁰ (1) to 10 ⁸ , selected in decade steps.
Accuracy ^{b c}		$\frac{\pm \text{Freq B}}{\text{Freq A} \times N}$ $\frac{\pm 1.4 \times \text{CH B trigger error} \times \text{Freq A}}{N}$ $\frac{+ \text{Freq into CH A}}{0.3 \times 10^8}$

Table 1-1 (cont)

Characteristics	Performance Requirements	Supplemental Information
FUNCTIONS (cont)		
TOTALIZE A Frequency Range	DC to 125 MHz.	Start/Stop function from front panel or rear interface. Overflows with >99,999,999 counts.
TIME MANUAL Clock Rate (Resolution)		10 sec to 100 ns (0.1 Hz to 10 MHz), selected in decade steps.
Range		100 ns to 10 ⁹ sec. Start/Stop function from front panel or rear interface.
INTERNAL TIME BASES		
Standard Time Base Frequency	10 MHz (100 ns).	Adjustable to ±1 part in 10 ⁷ , or better.
Temperature Stability (0° C to +50° C)		±5 ppm.
Aging		≤1 ppm/year.
Option 01 Time Base Frequency	10 MHz (100 ns).	Adjustable to ±2 parts in 10 ⁸ , or better.
Temperature Stability		±0.2 ppm of final frequency in less than 10 minutes when cold started at 25° C ambient.
Aging At Time of Shipping		1 part in 10 ⁸ /day, maximum.
Continuous Operation After 30 Days		4 parts in 10 ⁸ /week, maximum.
After 60 Days		<1 ppm/year.
Short Term Stability		≤1 part in 10 ⁹ (rms), based on 60 consecutive 1 second measurements.
Adjustment Range		Sufficient for 8 years of aging.

Table 1-1 (cont)

^a Time base error is the sum of all errors specified for the time base used.

^b N is the number of periods averaged in PERIOD B (AVGS) mode, the number of intervals averaged in the TIME A – B (AVGS) mode, the number of widths averaged in the WIDTH B (AVGS) and EVENTS A DURING B mode, and the number of periods of the CH B signal in the RATIO A/B mode.

^c CH A or CH B Trigger error (μ s rms)

$$= \frac{\sqrt{(e_{n1})^2 + (e_{n2})^2}}{\text{Input slew rate at trigger point (V/\mu s)}} \quad \text{or} \quad = \frac{\pm 0.3\% \text{ of one period}}{N \text{ periods}}, \text{ whichever is greater.}$$

The second formula is for signals with an S/N ratio better than 40 dB and greater than 100 mV rms amplitude. In the first formula, e_{n1} = typically 100 μ V (or less) rms internal noise and e_{n2} = input rms signal noise voltage for a 125 MHz bandwidth.

Table 1-2
MISCELLANEOUS

Characteristics	Description
Power Dissipation (Plug-in)	
Standard Instrument	Approximately 9.5 W.
Option 01 Instrument	Approximately 12.5 W.

Table 1-3
ENVIRONMENTAL^a

Characteristics	Description
Temperature	Meets MIL-T-28800B, class 5.
Operating	0°C to +50°C.
Non-operating	-55°C to +75°C.
Humidity	95% RH, 0°C to +30°C. 75% RH, 0°C to +40°C. 45% RH, 0°C to +50°C.
Altitude	Exceeds MIL-T-28800B, Class 5.
Operating	4.6 Km (15,000 ft).
Non-operating	15 Km (50,000 ft).
Vibration ^b	0.38 mm (0.015 inch) peak-to-peak, 10 Hz to 55 Hz, 75 minutes.
Shock ^c	30 g's (1/2 sine), 11 ms, 18 shocks.
Bench Handling ^d	Dropped from 45° or 4 inch or equilibrium, whichever occurs first.

Table 1-3 (cont)

Characteristics	Description	
Electromagnetic Compatibility	MIL-STD 461A/462	Meets MIL-T-28800B, Class 3.
Electrical Discharge	20 kV, maximum.	Charge applied to each protruding area except the input/output terminals.
Transportation ^d Vibration and Package Drop	Qualified under National Safe Transit Association Preshipment Test Procedures 1A-B-1 and 1A-B-2.	

^aWith power module, except where noted.

^b.26 mm (0.10 inch), 10 Hz to 55 Hz in TM 501, TM 503, TM 504, TM 506.

^c20 g's (1/2 sine), 11 ms, 18 shocks in TM 501, TM 503, TM 504, TM 506.

^dWithout power module.

Table 1-4
PHYSICAL CHARACTERISTICS

Characteristics	Description
Maximum Overall Dimensions	
Height	≈126.0 mm (4.96 inch).
Width	≈64.5 mm (2.54 inch).
Length	≈285.5 mm (11.24 inch).
Net Weight	
Standard Instrument	≈0.9 Kg (2.0 lb).
Option 01	≈1.0 Kg (2.2 lb).
Finish	
Front Panel	Plastic-aluminum laminate.
Chassis	Anodized aluminum.

SECTION 2

OPERATING INSTRUCTIONS

INTRODUCTION

This section of the manual provides installation and removal instructions and the operating information required to obtain the most effective performance from the instrument. Also included is the function of all front panel controls and a general description of the operating modes, which also describes procedures for making basic measurements.

INSTALLATION AND REMOVAL

The DC 503A is calibrated and ready to use when received. It operates in one compartment of a TM 500-Series power module. Refer to the power module instruction manual for line voltage requirements and power module operation.

CAUTION

To prevent damage to the DC 503A, turn the power module off before installation or removal of the instrument from the mainframe. Do not use excessive force to install or remove.

Check to see that the plastic barriers on the interconnecting jack of the selected power module compartment match the cutouts in the DC 503A circuit board edge connector. If they do not match, do not insert the instrument until the reason is investigated. When the units are properly matched, align the DC 503A chassis with the upper and lower guides of the selected compartment (see Fig. 2-1). Insert the DC 503A into the compartment and

press firmly to seat the circuit board edge connector in the power module interconnecting jack. Apply power to the DC 503A by operating the power switch on the power module.

To remove the DC 503A from the power module, pull the release latch (located in the lower left corner) until the interconnecting jack disengages. The DC 503A will now slide straight out.

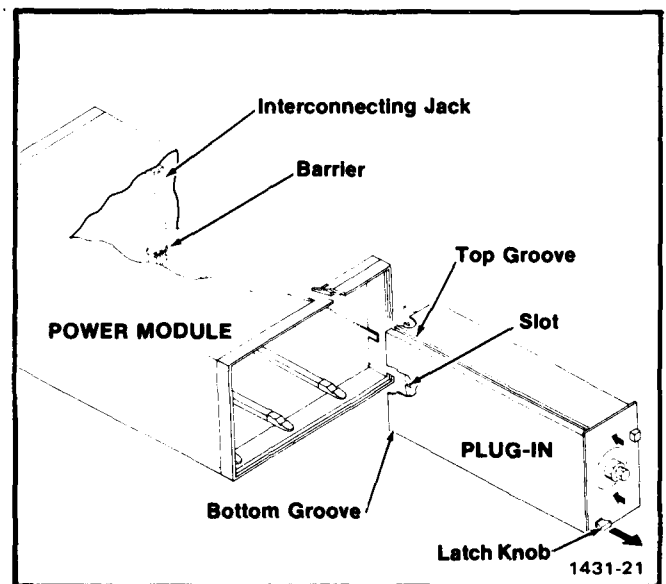

Fig. 2-1. Plug-in installation/removal.

CONTROLS AND CONNECTORS

Even though the DC 503A is fully calibrated and ready to use, the functions and actions of the controls and connectors should be reviewed before attempting to use it.

With the exception of the TOTALIZE/TIME MANUAL jumper, which is described in the maintenance section, all controls for operation of the DC 503A are located on the front panel. A brief functional description of these controls follows (refer to Fig. 2-2).

NOTE

Because the Channel A and Channel B controls are identical, only Channel A will be described.

DISPLAY AND UNIT INDICATORS

- ① **DISPLAY READOUT:** eight-digit, seven segment LED readout with automatically positioned decimal point.
- ② **OVERFLOW:** when illuminated indicates register overflow.
- ③ **GATE:** indicates the state of the main gate. When lit, the main gate is open (the DC 503A is in the process of making a measurement). When the light is off, the gate is closed.
- ④ **GHz/nSEC:** when illuminated, indicates the displayed number is gigahertz (GHz) in FREQ A mode or nanoseconds (nSEC) in a time mode.
- ⑤ **MHz/μS** when illuminated, indicates the displayed number is Megahertz (MHz) in FREQ A mode or microseconds (μSEC) in a time mode.
- ⑥ **kHz/mSEC:** when illuminated, indicates the displayed number is kilohertz (kHz) in FREQ A mode or milliseconds (m SEC) in a time mode.
- ⑦ **Hz/SEC:** when illuminated, indicates the displayed number is Hertz (Hz) in FREQ A mode or seconds (SEC) in a time mode.

MODE SELECTION AND CONTROL FUNCTIONS

- ⑧ **FUNCTION:** selects the measurement, events, or time counting modes for the counter.

NOTE

The TOTALIZE A/TIME MANUAL position is an "either/or" function. TOTALIZE A or TIME MANUAL is selected and set by positioning an internal jumper. Placement of this jumper is discussed in the maintenance section.

WARNING

Unless you are qualified to do so, refer positioning of this jumper to qualified personnel.

- ⑨ **AVGS/TIMING:** depending on the position of the FUNCTION switch, this switch selects the clock rate which will be counted or the number of measurements to be averaged.
- ⑩ **DISPLAY TIME:** sets the length of time the reading will be displayed after the count is made and before the next measurement is taken, Display time can be varied from about 0.1 second, fully counter-clockwise (ccw), to about 10 seconds fully clockwise (cw). The HOLD position provides continuous display until reset by pushing the RESET button,
- ⑪ **RESET:** momentary switch resets the count to zero when operating in the TOTALIZE A mode. Also acts as a master reset, ensuring that the readout has been cleared before the next measurement. Provides a check of all display LED's; when pressed, a row of 8's will be displayed in the readout window.
- ⑫ **START/STOP:** push-push switch acts as a manual gate when the FUNCTION switch is in the TOTALIZE A/TIME MANUAL position. Button in Starts the measurement interval gate; button out terminates the gate.

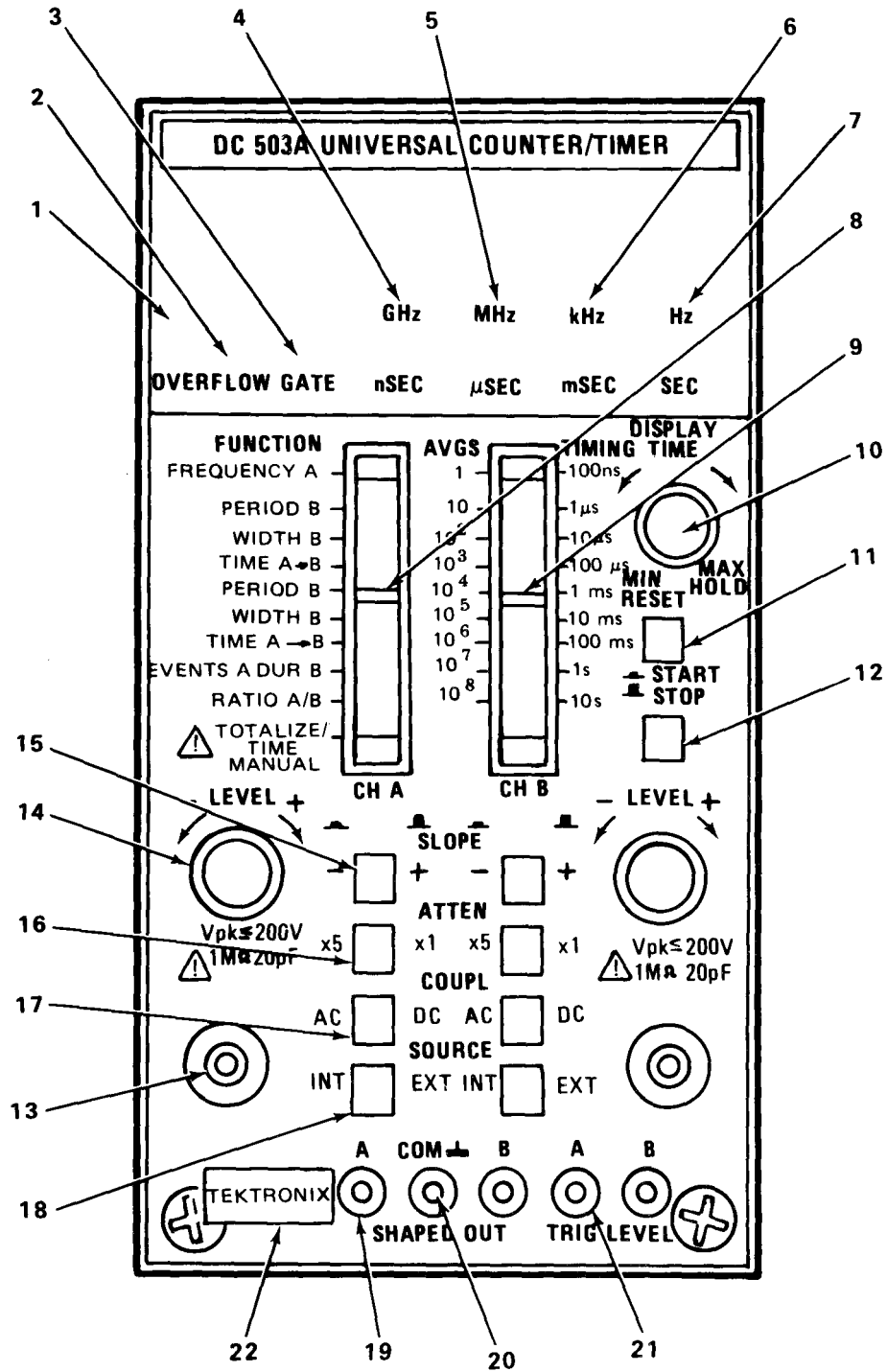

Fig. 2-2. Controls and connectors.

CHANNEL A INPUT AND LEVEL FUNCTIONS

- ⑬ **CH A INPUT:** bnc connector for Channel A signal input. Input impedance is $1\text{M}\Omega$ shunted by approximately 20 pF.
- ⑭ **LEVEL:** selects the amplitude point on the positive or negative slope of the input signal at which the triggering window is placed.
- ⑮ **SLOPE:** push-push switch selects the slope of the input signal on which triggering will occur, Button out selects plus (+) slope; button in minus (-) slope.
- ⑯ **ATTEN:** push-push switch selects X1 (button out) or X5 (button in) attenuation of the input signal.
- ⑰ **COUPL:** push-push switch selects DC (button out) or AC (button in) coupling of the input signal to the attenuator circuit.
- ⑱ **SOURCE:** push-push switch selects the source of the input signal. Button out, EXT, selects the front panel connector as a signal source. Button in, INT, routes the input signal to the counter via the rear interface connections.
- ⑲ **SHAPED OUT A:** provides a shaped output signal derived from the output of the Channel A signal shaper circuitry.
- ⑳ **SHAPED OUT GND:** common connector for Channel A shaped output signals.
- ㉑ **TRIG LEVEL A:** pin jack permits monitoring of the Channel A triggering voltage level.
- ㉒ **RELEASE LATCH:** pull to disengage and remove DC 503A from the power module.

INPUT CONSIDERATIONS

Input Sources



NOTE

Maximum input voltage limited to 200 V peak.

The SOURCE switch for each channel selects either the front panel bnc connector (external), or the rear interface connector (internal) pins. The external inputs present impedances of approximately $1\text{M}\Omega$ paralleled by about 27 pF. The internal input circuits present nominal 50 Ω impedances to match typical coaxial cable signal connections.

Input Coupling

Front panel pushbuttons select ac (capacitive) or dc (direct) coupling for the input signal of each channel. This coupling takes place before the signals are passed into the attenuator circuits.

Attenuators and Maximum Input Volts

For either attenuation factor, X1 or X5, the maximum safe input voltage that can be applied to the front panel bnc connectors is 200 V (peak) from dc to 50 kHz. At frequencies above 50 kHz, the maximum safe peak-to-peak input voltage to the front panel bnc connectors must

be calculated (see Specification section). The maximum safe input voltage to the rear interface input connectors is equal to or less than 4 V (dc plus peak ac) from dc to 50 MHz.

Sensitivity and Frequency Range

CH A and CH B will respond to a signal amplitude of 20 mV rms sinewave, times attenuation, to 100 MHz and to a sinewave of 35 mV rms, times attenuation, to 125 MHz.

Depending on the coupling mode selected, the low frequency limit for each channel is either zero (dc coupled) or 10 Hz (ac coupled).

Slope and Level

The SLOPE pushbuttons for each channel determine whether the trigger circuits will respond to the negative or positive transition of the input signal.

Refer to Fig. 2-3. The LEVEL control for each channel allows the operator to move the hysteresis window of the trigger circuit to an optimum level on the input signal to ensure stable triggering. The LEVEL control adjusts over $\pm 3.5\text{ V}$, times attenuation, of the input signal. This level can be monitored at the front panel TRIG LEVEL pin jacks.

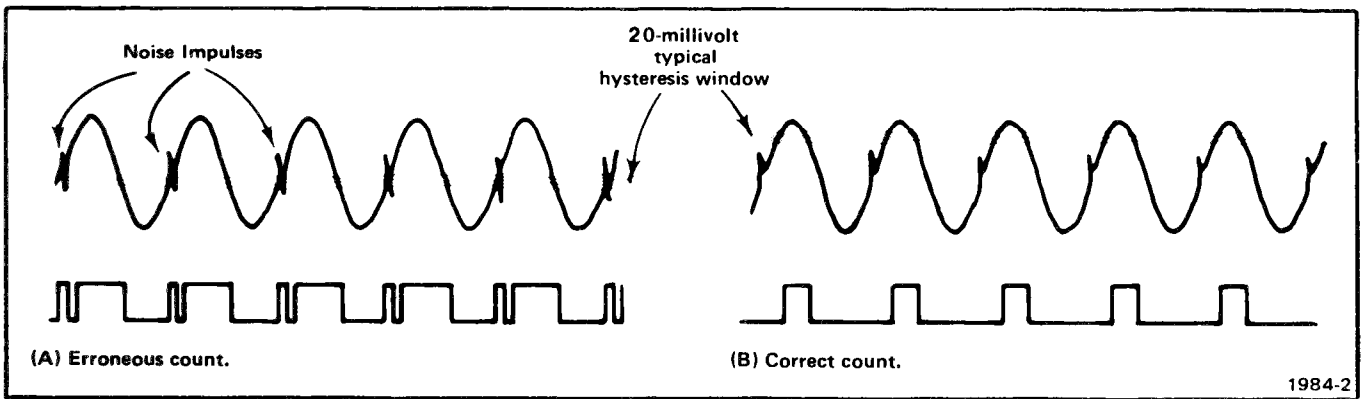

Fig. 2-3. Triggering circuit response to improper (A) and proper (B) level settings.

OPERATORS FAMILIARIZATION

PREPARATION

Turn on the power module to apply power to the DC 503A. One or more characters in the display should be visible. Allow twenty minutes warm-up time for operation to specified accuracy.

DISPLAY TESTS

With no signal applied, test the DC 503A readout displays and switching logic. The following checks will test most of the major circuits of the counter and ensure its readiness to make measurements. If any malfunctions are encountered, refer the condition to qualified service personnel.

Readout Segment Test

Press the RESET button to check the seven character segments of each digit. A row of 8's should be displayed. This check of the display devices can be done at anytime.

Frequency A Displays

Set the FUNCTION switch to FREQUENCY A. With the AVGS/TIMING switch, select a gate time of 100 ns. Check the decimal point location, leading zero suppression, and units indicators according to Table 2-1.

Table 2-1

FREQUENCY A DISPLAY CHECK

AVGS/TIMING Switch Setting	Unit Indicators	Decimal Point Display
100 ns	GHz/nSec	0.00
1 μ s	MHz/ μ Sec	0
10 μ s	MHz/ μ Sec	0.0
100 μ s	MHz/ μ Sec	0.00
1 ms	MHz/ μ Sec	0.000
10 ms	MHz/ μ Sec	0.0000
100 ms	kHz/mSec	0.00
1 s	kHz/mSec	0.000
10 s	kHz/mSec	0.0000

With the DISPLAY TIME control in the fully counterclockwise position, observe that the GATE indicator flashes rapidly for short gate times and more slowly for longer gate times. Using a short gate time (100 ms), rotate the DISPLAY TIME control slowly clockwise. Observe that the GATE indicator stays off for a longer and longer time, until the control clicks into the HOLD (detent) position, holding off the gate indefinitely. Return the DISPLAY TIME control to the counterclockwise position.

Period B, Width B, and Time A - B Displays

Timing Mode. Set the FUNCTION switch to PERIOD B in the blue area of the front panel and the AVG/TIMING switch to 100 ns. Observe the correct readout displays as shown in Table 2-2.

Table 2-2

PERIOD B, TIME A - B, WIDTH B
(TIMING MODE) DISPLAY CHECK

AVGS/TIMING Switch Setting	Unit Indicators	Decimal Point Display
100 ns	MHz/ μ Sec	0.0
1 μ s	kHz/mSec	0.000
10 μ s	kHz/mSec	0.00
100 μ s	kHz/mSec	0.0
1 ms	Hz/Sec	0.000
10 ms	Hz/Sec	0.00
100 ms	Hz/Sec	0.0
1 s	Hz/Sec	0
10 s		0.00

Set the FUNCTION switch to WIDTH B in the blue area of the front panel while retaining the setting of the AVG/TIMING switch; observe the correct readout display.

Set the FUNCTION switch to TIME A - B in the blue area of the front panel while retaining the setting of the AVG/TIMING switch; observe the correct readout display.

Averaging Mode. Repeat the preceding checks for these functions in the dark grey area of the front panel. Observe the correct readout display for each switch setting as shown in Table 2-3.

Table 2-3

PERIOD B, TIME A - B, WIDTH B
(AVERAGING MODE) DISPLAY CHECK

AVGS/TIMING Switch Setting	Unit Indicators	Decimal Point Display
1	kHz/mSec	0.0000
10	kHz/mSec	0.00000
10 ²	kHz/mSec	0.000000
10 ³	MHz/ μ Sec	0.0000
10 ⁴	MHz/ μ Sec	0.00000
10 ⁵	MHz/ μ Sec	0.000000
10 ⁶	GHz/nSec	0.0000
10 ⁷	GHz/nSec	0.00000
10 ⁸	GHz/nSec	0.000000

Events A During B and Ratio A/B Displays

Set the FUNCTION switch to EVENTS A DURING B and the AVGS/TIMING switch to 1. Check the readout displays according to Table 2-4.

Set the FUNCTION switch to RATIO A/B and the AVGS/TIMING switch to 1. Again check the readout displays using Table 2-4.

Table 2-4

RATIO A/B AND EVENTS A
DURING B DISPLAY CHECK

AVGS/TIMING Switch Setting	Decimal Point Display
1	0
10	0.0
10 ²	0.00
10 ³	0.000
10 ⁴	0.0000
10 ⁵	0.00000
10 ⁶	0.000000
10 ⁷	0.0000000
10 ⁸	0

Time Manual Displays

Verify that the jumper located on the Auxiliary Circuit Board is in the TIME MANUAL position. Set the FUNCTION switch to the TIME MANUAL Position and the AVGS/TIMING switch to 1 sec.

The GATE indicator should light and an advancing count should be displayed when the START/STOP button is pushed in. The GATE indicator should go out when the count is stopped by releasing the START/STOP button. Check the overflow display by setting the AVGS/TIMING switch to 100 ns pressing the START/STOP button in, and letting the count advance. When the last decade (eighth digit) goes from nine to zero the OVERFLOW indicator will light. Release the START/STOP button and observe that the OVERFLOW indicator remains on, but the count does not change. Pressing the RESET button clears the overflow condition, sets the count to zero, and extinguishes the OVERFLOW indicator.

Totalize A Display

For this check, the jumper located on the Auxiliary Circuit Board must be in the Totalize position.



Unless you are qualified to do so, refer placement of this jumper to qualified personnel.

Set the FUNCTION switch to the TOTALIZE A/TIME MANUAL position. Observe a zero at the right of the readout display. The GATE indicator should light when the START/STOP button is pushed in, and go out when the button is released. The units indicators and decimal points should remain off.

Channel A Slope

Verify that the TOTALIZE/TIME MANUAL jumper is in the TOTALIZE position. With the FUNCTION switch set to TOTALIZE A/TIME MANUAL and CH A to + SLOPE (button out), press the START/STOP button. Turn the CH A LEVEL control fully clockwise. The readout display should increase one count each time the control is rotated from clockwise to counterclockwise (past center position). Verify that the count does not increase when the control is turned from counterclockwise to clockwise.

Change to - SLOPE (button in) and push the RESET button to clear the display. The readout should now increase one count each time the CH A LEVEL control is rotated from counterclockwise to clockwise (past center). Turning the control from clockwise to counterclockwise should not increment the display.

Channel B Slope

Set the FUNCTION switch to PERIOD B, CH B to + SLOPE (button out), and the AVGS/TIMING switch to 1. Push the RESET button. Check that the GATE indicator turns on when the CH B LEVEL control is rotated from clockwise to the counterclockwise position. Turning the control back to clockwise should have no effect on the GATE indicator. Another turn from clockwise to counterclockwise turns the GATE indicator off.

Change to - SLOPE (button in) and press the RESET button. Observe that rotating the CH B LEVEL control from counterclockwise to clockwise and back produces an action that is just opposite that described in the preceding paragraph.

OPERATING MODES

GENERAL

The following discussion provides general information about each mode of operation and instructions on making measurements for FREQUENCY A, RATIO A/B, TIME INTERVAL (WIDTH B and TIME A - B), EVENTS A DURING B, and TOTALIZE.

FREQUENCY A MODE

In this mode the input signal is connected to CH A Input only, either through the rear interface or the front panel connector. Use ac coupling for most frequency measurements to avoid readjusting the LEVEL control because of changing dc levels. The repetitive nature of the signals makes slope selection unnecessary for frequency measurements. Signals less than 3 volts peak-to-peak need not be attenuated; larger signals should be attenuated to within the range of 60 mV to 3 V peak-to-peak.

Set the FUNCTION switch to FREQUENCY A and, with the AVGS/TIMING switch, select one of the shorter gate times. Set the DISPLAY TIME control fully counterclockwise. Connect the signal to be measured to the input and adjust the LEVEL control for a stable display. The LEVEL control setting should not be critical unless the signal amplitude and frequency are close to the specified limits.

If the count varies from reading to reading, it is probably caused by jitter in the signal source. If the count

changes unreasonably, the DC 503A is not being triggered properly, either because the controls are not correctly set or the signal is beyond the capabilities of the counter.

Measurement Intervals. To adjust the trigger controls, choose a short gate time such as .1 second or .01 seconds. This gives rapid feedback via the display whether or not the counter is being triggered. Final selection of gate time depends upon the frequency being measured, desired resolution, and willingness of the operator to wait for a measurement.

Resolution. A 10 second gate time means the operator must wait 10 seconds for a measurement to be made and displayed. This will give 0.1 Hz resolution. A 10 second count will display fewer than the available eight digits for any signal below 10 MHz.

Overflow. Through intentional use of "overflow" displays, it is possible to improve the resolution of the counter. Select a gate time that displays the most significant digit as far to the left as possible. Note the numbers displayed to the right of the decimal. Move the decimal to the left, by selecting longer gate times, until the desired resolution is achieved. The OVERFLOW indicator will light when the most significant number overflows the last storage register. The relationship between gate time, measured frequency, displayed digits, and overflow is shown in Table 2-5.

Table 2-5

GATE TIME vs MEASUREMENT RESOLUTION

Gate Time	≥100 MHz	10 MHz to 100 MHz	1 MHz to 10 MHz	≤1 MHz	LSD
100 μS	2 digits	1 digit			.01 GHz
1 μS	3 digits	2 digits	1 digit		1 MHz
10 μS	4 digits	3 digits	2 digits	1 digit	0.1 MHz
100 μS	5 digits	4 digits	3 digits	2 digits	.01 MHz
1 mS	6 digits	5 digits	4 digits	3 digits	.001 MHz
10 mS	7 digits	6 digits	5 digits	4 digits	.0001 MHz
100 mS	8 digits	7 digits	6 digits	5 digits	.01 kHz
1 S	OVERFLOW	8 digits	7 digits	6 digits	.001 kHz
10 S	OVERFLOW	OVERFLOW	8 digits	7 digits	.0001 kHz

Measurement Rate. Once a stable measurement is obtained, the rate at which measurements are made can be controlled by the DISPLAY TIME control. Turning the control clockwise holds off the gate and stores the display for a longer time before a new measurement is made and displayed. Display time and gate time together complete a measurement-display cycle.

The DISPLAY TIME control is uncalibrated and variable from about 0.1 second (in the MIN position) to about 5 seconds. At the extreme clockwise end of the control is a detent position called HOLD. In HOLD, the last count taken will be stored and displayed for an indefinite period. A new count and display can be initiated by pressing the RESET button, moving the DISPLAY TIME control out of the detent, or changing the gate time.

PERIOD MODES

The period and period average modes allow single period measurements or multiple period averages to be made with input frequencies into CH B. These modes are useful for making low frequency measurements where maximum resolution is desired without waiting for long measurement time. Simply stated, the PERIOD B mode reverses the functions of signal and clock as compared to FREQUENCY A mode. Refer to Fig. 2-4A.

Averaging. Resolution and accuracy is improved by averaging the signal value over a large number of signal events. This increases the total time to take a measurement, i.e., similar to selecting a longer gate time in FREQUENCY A mode. Refer to Fig. 2-4B.

Low Frequencies. Period Measurements of signals below 10 Hz, and particularly in the lowest decade from 0.1 Hz to 1.0 Hz, become rather sensitive to wave shape and amplitude. Since it is desirable for the signals to pass through the trigger hysteresis abruptly, square waves are

preferred. Other wave shapes can be accurately measured if the amplitude is kept high.

TIME INTERVAL MODES

Two modes of time interval measurement can be selected: WIDTH B, and TIME A - B. The WIDTH B mode measures the time between two points on a waveform. These two points are selected by the CH B triggering controls such that the counter main gate turns on at the point selected by the CH B SLOPE and LEVEL controls, and turns off at the same level but the opposite slope. Refer to Fig. 2-4C.

The TIME A - B mode measures the time between two points on two waveforms. These two points are controlled such that the CH A triggering controls select the point at which the main gate turns on, and the CH B controls select the point at which the main gate turns off. Refer to Fig. 2-4D.

Triggering. The voltage levels necessary to establish the triggering points on any selected slope are monitored and set with digital voltmeter readings at the CH A/CH B TRIG LEVEL pin jacks on the front panel or rear interface connections. Fig. 2-5 illustrates typical TRIG LEVEL voltage settings for various time interval measurements. When making these measurements, each channel must be dc coupled and coaxial cables must be properly terminated in order to maintain signal fidelity.

WIDTH B Mode. In order to measure pulse duration (Fig. 2-5, waveform 3), the 50% level must be determined. Set the FUNCTION switch to WIDTH B and the CH B LEVEL control fully counterclockwise. Apply the input signal to the CH B input connector. The GATE indicator must be off.

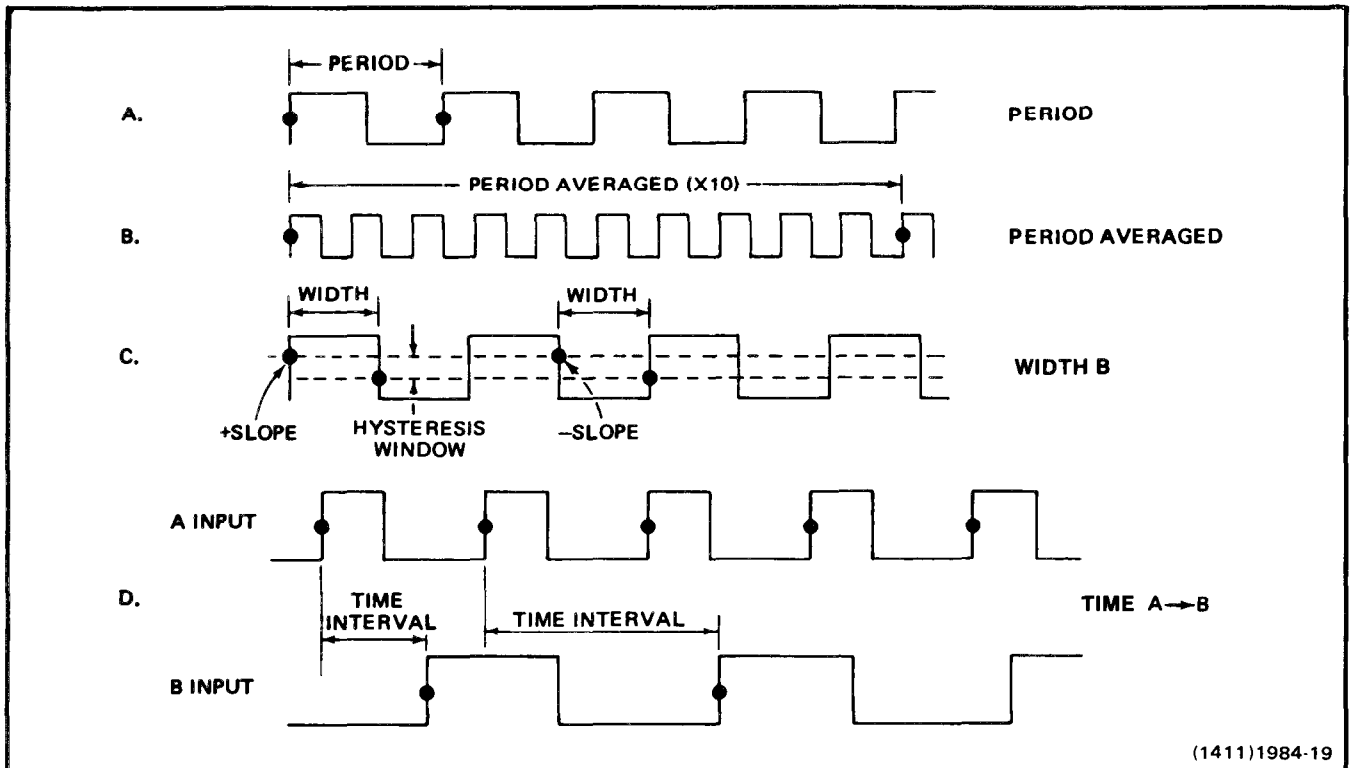

Fig. 2-4. Representation of Interval measurements.

Rotate the LEVEL control until the GATE indicator just come on and record the digital voltmeter reading. Continue rotating the LEVEL control until the GATE indicator just goes off and record the digital voltmeter reading. Subtract the first digital voltmeter reading from the second and divide by 2; this is the 50% level.

Reset the CH B LEVEL control so that the digital voltmeter indicates the 50% level. Read the pulse duration from the DC 503A display.

Time A - B Mode. This measurement requires input signals to both CH A and CH B, but the peak-to-peak signal amplitude should first be determined using the WIDTH B mode instructions. For TIME A - B measurements, follow these steps:

1. Set the FUNCTION switch to WIDTH B.
2. Referring to WIDTH B mode instructions, determine the peak-to-peak amplitude and desired triggering level of the signal to be applied to the Channel B input.
3. If the signal to be applied to Channel A input is different than that being applied to Channel B, repeat Step 2 for this signal.

4. Set the Channel B LEVEL control to the desired triggering level as calculated in Step 2.

5. Set the FUNCTION switch to TIME A - B.

6. Set the Channel A LEVEL control to the desired triggering level as calculated in Step 3.

7. With signals connected to the proper channels, read the elapsed time interval between the triggering level of Channel A and the subsequent triggering level of Channel B from the DC 503A display.

Time Interval Averaging. Averaging can be used to increase the accuracy and resolution of repetitive signal measurements. The basic reason for averaging is the **statistical reduction of the ± 1 count error**. If the ± 1 count error is truly random, then as more intervals are averaged, the measurement will tend to approach the true value of the time interval. For time interval averaging to work, the time interval being measured must be repetitive and have a repetition frequency that is nonsynchronous to the counter clock rate. The DC 503A will measure up to 10" averages in both Width B averaging and TIME A - B averaging.

(1411)1984-19

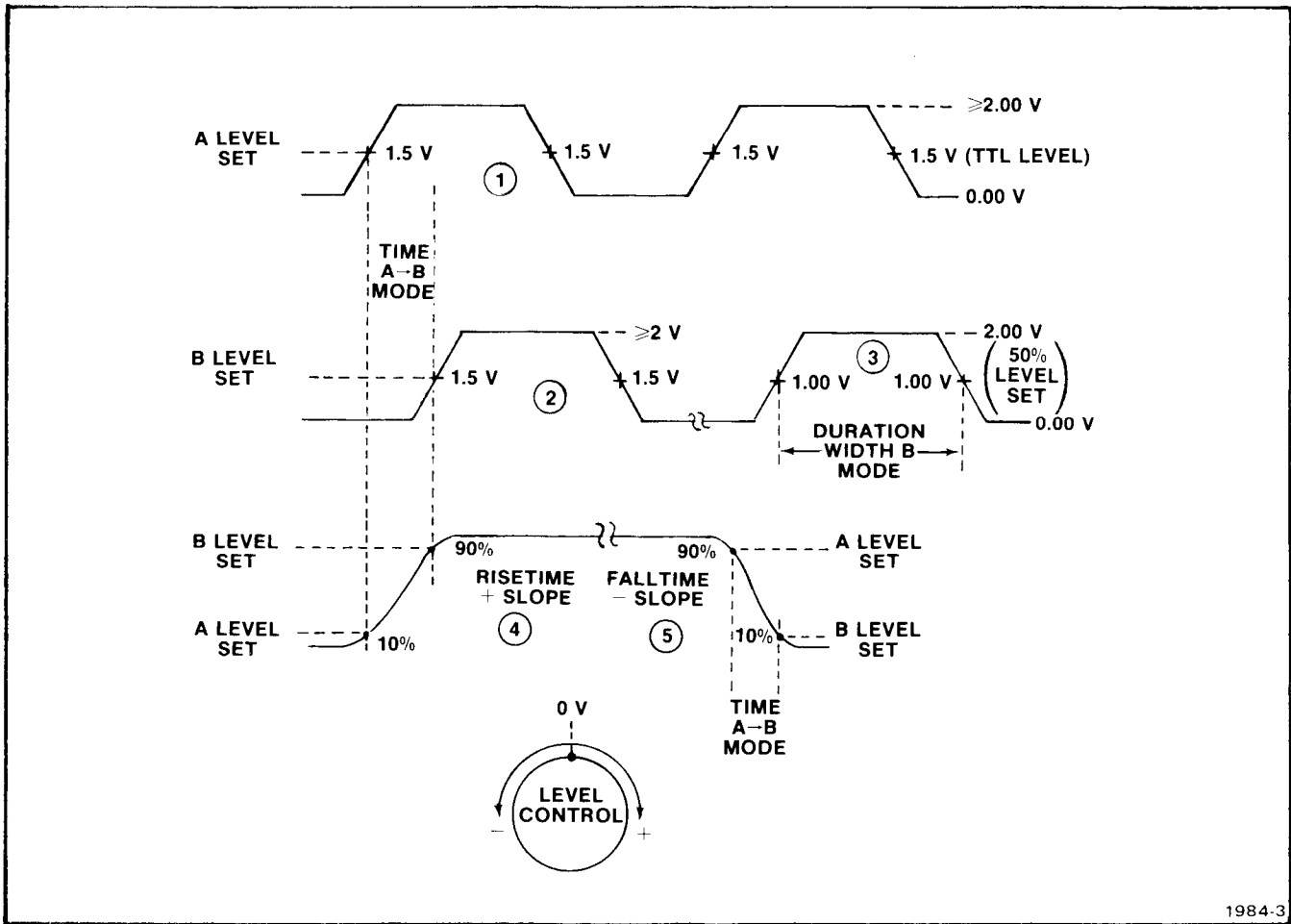

Fig. 2-5. Typical CH A and CH B Level Out voltage settings for various time interval measurements.

EVENTS A DURING B MODE

In the EVENTS A DURING B mode, the events applied to Channel A are counted. The count is gated by the signal applied to Channel B input. The accumulated total of events A that arrived during the time signal B was triggered is displayed in the readout. Refer to Fig. 2-6.

The following procedure can be used to make a measurement like that shown in Fig. 2-6.

1. Apply the signal to be counted to Channel A. With the FUNCTION switch at FREQUENCY A, set Channel A SLOPE switch to + SLOPE. Adjust the LEVEL control for a stable display.
2. Apply the control signal to Channel B. With the FUNCTION switch at PERIOD B, set Channel B SLOPE switch to + SLOPE, Adjust the LEVEL control for a stable display.

3. Set the FUNCTION switch to EVENTS A DURING B.

When the Channel B signal excursion occurs, Channel B is triggered and the gate opens, allowing the Channel A pulses to be counted.

Averaging. Averaging can be used to increase the accuracy and resolution of repetitive event per interval measurements. As more events are averaged, the measurement tends to approach the true value of the number of events per interval.

RATIO MODE

The DC 503A may be used to measure the ratio of two signals, where one signal is applied to Channel A input and the other signal is applied to Channel B input.

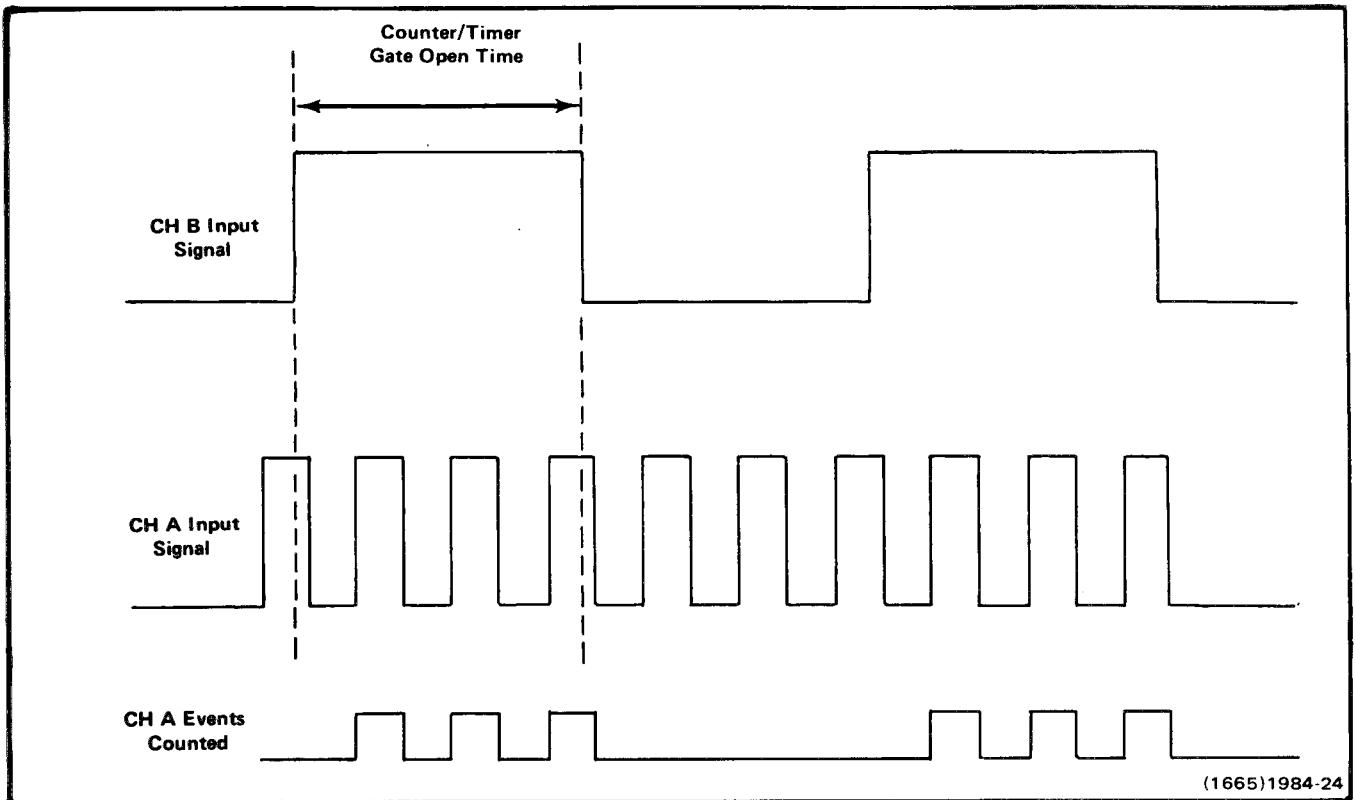

(1665)1984-24

Fig. 2-6. Illustration of CH A events counted from portion of CH A signal pulses during the counter gate open time (controlled by CH B signal).

In the Ratio A/B mode, the frequency of the signal applied to Channel A is divided by the frequency of the signal applied to Channel B, and the resultant ratio is displayed.

Triggering. The operation of Channel A and Channel B trigger controls is the same as for frequency and period measurements. Set the trigger controls as follows:

1. Go to the FREQUENCY A mode and adjust the Channel A trigger controls for a normal frequency measurement.
2. Go to the PERIOD B mode and adjust the Channel B trigger controls for a normal period measurement.
3. Leaving the Channel A and Channel B trigger controls as they are, go to the RATIO A/B mode. The correct ratio should be displayed.

Resolution. The AVGS/TIMING switch, which controls the number of averages of the Channel B signal, may now be set to display maximum resolution. For most

measurements, the smallest number of averages that produces a useful number of digits should be considered.

TIME MANUAL MODE

This mode is a manual analog of the TIME A - B mode. In this mode, only the AVGS/TIMING switch and START/STOP switch affect the display.

Starting and Stopping. The TIME MANUAL mode may be thought of as a "stop-watch" type of operation. With the FUNCTION switch in the TIME MANUAL position (and the internal jumper properly positioned), the display starts counting time-base pulses when the START/STOP switch is depressed. It will continue to count and display the accumulated total until the START/STOP switch is released. The last count will then be held in the display until another START command is given (in which case the count will again advance), or other controls are actuated. Pressing the RESET button will return the display to zero. Changing the setting of the AVGS/TIMING switch will change the frequency of the time-base pulses being counted and reset the display to zero. The start/stop function can also be performed remotely via the rear interface connections.

TM 9-6625-474-14&P-3

Clocking Rate. When the AVGS/TIMING switch is in the 1 s position, one-second pulses are being counted and the display accumulation advances one count per second, and so on.

Whenever the accumulated count is above 99,999,999, the OVERFLOW indicator will light to indicate register overflow; however, the accumulation continues at the normal rate, except that digits for decades above 10^8 are not displayed.

TOTALIZE A MODE

This mode is a manual analog of the FREQUENCY A mode. In this mode, signal event supplied to the Channel A input are counted and the accumulated total displayed during the time the START/STOP button is depressed to the START position. The main application of this mode is to accumulate the count of relatively infrequent and irregular events.

Operation. Apply the signal to Channel A input and set the trigger controls the same as for a frequency measurement. Only the Channel A trigger controls, the RESET button, and the START/STOP button affect the display in this mode.

Starting the Count. Press the START/STOP button and adjust the Channel A LEVEL control until a count begins to advance. The accumulated count is displayed in whole numbers.

Stopping the Count. If the START/STOP button is released and no other controls are actuated, the last total

will continue to be displayed. No more incoming events will be added to the total.

Restarting and Resetting. When the START/STOP button is again depressed, incoming events will advance the displayed total. Resetting the count to zero can be done at any time by pressing the RESET button.

Remote start/stop. Starting and stopping the count can be accomplished remotely via connections to the rear interface.

REPACKAGING FOR SHIPMENT

If the Tektronix instrument is to be shipped to a Tektronix Service Center for service or repair, attach a tag showing: owner (with address) and the name of an individual at your firm that can be contacted. Include complete instrument serial number and a description of the service required.

If the original package is not fit for use or not available, repackage the instrument as follows:

Surround the instrument with polyethylene sheeting, or other suitable material, to protect the exterior finish. Obtain a carton of corrugated cardboard of adequate strength and having inside dimensions no less than six inches more than the instrument dimensions. Cushion the instrument by tightly packing dunnage or urethane foam between the carton and the instrument, on all sides. Seal the carton with shipping tape or an industrial stapler.

The carton test strength for your instrument is 200 pounds.

SECTION 3

THEORY OF OPERATION

BLOCK DIAGRAM DESCRIPTION

Introduction

For the following block diagram description refer to the Block Diagram foldout page at the rear of this manual.

Channel A and Channel B Amplifiers

There are two inputs, CH A and CH B. Signals to be counted or timed are applied to either or both channels via front panel bnc connectors or via the rear interface. The front panel inputs for both channels are terminated with an **impedance corresponding to a resistance of 1 M Ω** , paralleled with approximately 27 pF. The rear interface inputs to both channels are terminated with a resistance of **approximately 50 Ω** . Both channels are identical up to the Signal Flouting circuits.

Each channel contains an ac/dc coupling switch, a X1 or X5 attenuation network, a buffer amplifier circuit acting as a comparator that compares the incoming signal level against the triggering level as a reference, and amplifier/Schmitt circuits driving the signal slope selection functions in the Signal Routing circuits. Each channel also contains an operational amplifier serving as a X1 buffer circuit, supplying a buffered version of the trigger level at the front panel tip jacks or rear interface connections.

NOTE

The remainder of this block diagram description discusses the signal paths through the remaining circuit blocks and the typical events related to each mode of operation (FUNCTION) listed on the front panel.

FREQUENCY A (Variable Gate)

For this mode of operation the CH A signal passes directly through the Signal Routing circuits to the Decade Accumulators. The signal is counted by the 1st DCU, then the 2nd DCU, and then by the 6-Decade Counter (a total of eight decades). In the FREQUENCY A mode the **Time Base signal is routed to the $\div N$ Circuit (variable gate)** to generate a Measurement Gate (via the Gate Generator) for the desired measurement time. At the end of the Measurement Gate interval, the accumulated count is latched in the 8-Decade Latch/Multiplexer circuits, converted from BCD to 7-segment information and displayed on the front

panel with the proper decimal point location and correct annunciator illuminated.

The Measurement Cycle Timing circuit determines the Display Time, clears the Gate Generator circuits, loads (latches) the decade counters, and resets the counters for the next measurement cycle in all modes of operation.

PERIOD B (Variable Clock)

In this TIMING mode, the CH B signal is passed through the Signal Routing circuits to the Gate Generator and the Time Base signal is routed to the $\div N$ Circuit (variable clock). The $\div N$ output is routed to the Count Input of the Decade Accumulators and the Measurement Gate is generated by a single period of the signal from Channel B. As before, the accumulated count for this mode and all subsequent modes is latched, decoded from BCD data to 7-segment information, and displayed on the front panel with the correct annunciator illuminated and the proper decimal point location.

PERIOD B (Averageable—100 ns Clock)

For this AVGS mode, the Time Base signal (10 MHz = 100 ns) is not divided; it is applied through the Signal Routing circuits directly to the Count Input of the Decade Accumulators. The CH B signal is routed to the $\div N$ Circuit. The $\div N$ output causes the Gate Generator to generate a Measurement Gate interval equal to 10^n periods of the CH B signal. The Time Base is counted for 10^n periods before the accumulated count is latched for display.

WIDTH B (Variable Clock)

In this TIMING mode, the 10 MHz Time Base is routed to the $\div N$ Circuit. The $\div N$ output (variable clock) is routed directly to the Count Input of the Decade Accumulators. The CH B signal is used to generate the Measurement Gate (via the Gate Generator). A single pulse width at the output of the Channel B amplifier generates the gate.

WIDTH B (Averageable—100 ns Clock)

In WIDTH B, AVGS mode, the Time Base signal is not divided by N; it is routed directly to the Count Input of the

TM 9-6625-474-14&P-3

Decade Accumulators. The pulses at the output of the Channel B amplifier are routed through the $\div N$ Circuit whose output causes the Gate Generator to develop a Measurement gate equal to 10^n pulse widths.

Counts are accumulated in the decade counters during either the positive portions of the pulse widths or the negative portions, dependent on the SLOPE polarity selection for the Channel B signal.

TIME A \rightarrow B (Variable Clock)

The TIME A \rightarrow B, TIMING mode, varies from the WIDTH B (Variable Clock) mode only in that the pulse width that generates the Measurement Gate is derived from the Time A \rightarrow B Generator. The outputs of both Channel A and Channel B amplifiers are applied to the Time A \rightarrow B Generator. The pulse width starts on the rising edge of the Channel A signal and ends on the rising edge of the Channel B signal. By changing the signal SLOPE polarity for Channel A or Channel B, the width can be from the rising edge of A to the falling edge of B, or any other combination.

For this mode the 10 MHz Time Base signal is routed to the $\div N$ Circuit whose output is then routed directly to the Count Input of the Decade Accumulators. Again, the Measurement Gate interval is dependent on the pulse width at the output of the Time A \rightarrow B Generator.

TIME A \rightarrow B (Averageable—100 ns Clock)

This AVGS mode has the signals from Channel A and Channel B also applied to the Time A \rightarrow B Generator circuit. The Time A \rightarrow B Generator output is then routed to the $\div N$ Circuit whose output causes the Gate Generator to produce the Measurement Gate interval. For this mode, the 10 MHz Time Base signal is routed directly to the Count Input of the Decade Accumulators. The count is accumulated for 10^n pulse widths from the Time A \rightarrow B Generator.

EVENTS A DURING B (Averageable)

This mode is exactly like the WIDTH B (Averageable) mode, except that the output of the Time Base is disabled and the output of Channel A is applied directly to the Count Input of the Decade Accumulators. For this mode, the pulse width at the output of Channel B is routed to the $\div N$ Circuit whose output causes the Gate Generator to produce the Measurement Gate Interval. The Channel A events are averaged for 10^n pulse widths from Channel B.

RATIO A/B (Averageable)

The Time Base output is disabled and not used for this mode; Channel A signals are routed directly to the Count

Input of the Decade Accumulators. The Channel B signals drive the $\div N$ Circuit, causing the Gate Generator to generate the Measurement Gate. The Measurement Gate interval is actually 10^n times the number of Channel B signals and the Channel A signals are counted during that time.

TOTALIZE A

In the TOTALIZE A mode the Measurement Gate is generated by the START/STOP switch on the front panel or via the Remote Start/Stop line at the rear interface. The Channel B, Time A \rightarrow B Generator, Time Base, $\div N$ Circuit, and Gate Generator circuits are not used for this mode. Instead of accumulating clock signals from the Time Base or signals from the $\div N$ Circuit, the Channel A signals are accumulated during the START/STOP interval.

TIME MANUAL (Variable Clock)

For this mode there are no inputs to Channel A or Channel B. The 10 MHz Time Base is routed to the $\div N$ Circuit whose output is routed directly to the Count Input of the Decade Accumulators. The Measurement Gate interval is generated either by using the START/STOP switch on the front panel or by changing the voltage level on the Remote Start/Stop input at the rear interface.

Decade Accumulators, 6-Decade Counter/8-Decade Latch

The 1st DCU consists of ECL flip-flops, requiring ECL/TTL conversion to drive the first decade latch. The 2nd DCU operates at TTL levels and drives the second decade latch directly. From that point, there are six more internal counters and six more decades of latch, all contained in one integrated circuit. This arrangement provides a total of eight decades of count and eight decades of latch.

The 6-Decade Counter/8-Decade Latch circuit has its own internal oscillator to generate the Time Slot information. It also generates the Scan Clock, Overflow, and BCD output data. Between the time slots and BCD data there is enough information to drive the Display. The zero blanking function is also provided internally.

Measurement Cycle Timing

The display timing, reset, clear, and load (latch) functions for the decade counters are provided by the Measurement Cycle Timing circuit.

Decimal Point and Annunciator Encoder

The decimal point location is determined by encoding circuits using the time slot information and information

derived from two programmable read-only memory (PROM) devices that look at the settings for the FUNCTION and AVGS/TIMING Switching Logic circuits. Four of the six annunciators are also encoded with data from the PROM devices.

Time Base

The standard 10 MHz (100 ns) clock is generated by a crystal controlled Colpitts oscillator The Option 01

counter has a 10 MHz, self contained, proportional temperature controlled oven oscillator for increased accuracy and stability.

Power Supplies

The power supplies for the instrument accepts the raw ± 33 Vdc and +11.5 Vdc from the power module and generate the ± 12 V regulated power, the 5 V regulated power, and the +2.7 V termination supply used in the ECL circuits.

DETAILED CIRCUIT DESCRIPTION

Introduction

Complete schematic diagrams are found in the Diagrams and Illustrations section at the rear of this manual. Refer to the preceding Block Diagram Description and to the indicated schematic diagram numbers throughout the following circuit description.

(R1226). Resistor R1627 (R1224) limits the high frequency gate current, while capacitor C1720 (C1120) compensates for the capacitance around the gate circuitry of the input differential amplifier.

The input differential amplifier, Q1630 (Q1230), has very high input impedance and transconductance, High common mode rejection for the differential amplifier is provided by a constant current source, Q1620 (Q1220) and associated components.

CH A and CH B Amplifiers



NOTE

Since both amplifier circuits are identical, this description discusses the theory of operation for Channel A Amplifier with the associated circuit component for Channel B Amplifier listed in parenthesis.

The other gate of the DMOS FET pair is connected to the Trigger Level control R500 (R600) and the trigger level output circuit, U1620 (U1220) and associated components. The Trigger Level control sets the dc reference level to which the input voltage is compared. The counter measurements are made with respect to the dc reference level set by R500 (R600). The trigger level range is ± 3.5 V.

The input signal applied to the input bnc connectors of each channel, J510 (J610), passes through three switches to the gate connection of a DMOS FET differential amplifier, Q1630 (Q1230). The EXT/INT switch, S1732 (S1031), activates relay K1810 (K1800) to select either the front panel input or the rear interface connection, P1900-16A (P1900-17B). The rear interface input connection is terminated internally with a 51 Ω resistor, R1731 (R1132). After input selection the signal coupling method is chosen by the ac or dc coupling switch for each channel, S1731 (S1030). The dc component of the signal is removed by capacitor C1830 (C1030), resulting in a signal that varies around its average level. Attenuation of the input signal, X1 or X5, is determined by the setting of S1730 (S1021).

The buffer amplifier circuit, U1620 (U1220) and associated components, has a high input impedance and approximately unity gain, minimizing the loading effect on the differential amplifier. The CH A (CH B) Level Out value is very close to the dc level set by the Trigger Level control. Potentiometer R1525 (R1420) is adjusted to compensate for the offset voltages of the differential amplifier and buffer circuits.

Four diodes, CR1620, CR1720, CR1621, and CR1721 (CR1220, CR1120, CR1221, and CR1121) are provided to limit the input voltage to Q1630 (Q1230). Clamping occurs at approximately +6 V or -13 V. The diode clamping circuits are protected against excessive current by R1629

The output of the DMOS FET pair is applied differentially to the input of a three stage line receiver circuit, U1530C, U1530B, and U1530A (U1330A, U1330B, and U1330C). The first stage of the line receiver, U1530C (U1330A), operates as a transresistance amplifier to lower the load impedance on the differential amplifier.

The second stage of the line receiver, U1530B (U1330B), operates as a voltage amplifier with a gain of

approximately three. The differential output from this voltage amplifier drives the Schmitt trigger circuit, U1530A (U1330C). The Schmitt trigger circuit shapes the input signal and drives the SLOPE selection gates on schematic 3.

Introduction to Signal Routing



NOTE

Before reading this part of the detailed circuit description, refer to the Block Diagram Description for basic signal path information.

Signal slope selection for each channel of the DC 503A is provided by exclusive-OR gates, U1421A for Channel A and U1421 B for Channel B. A high voltage level on pin 5 of U1421A or pin 7 of U1421B inverts the input signal on pin 5 or pin 9 of U1421. Both gates have complemented outputs, pins 2 and 11.

The outputs from the slope selection gates go to the SHAPED OUT tip jacks, J520 and J540, after buffering by Q1420 and Q1530, respectively. The Channel A signal also goes to pin 12 of U1420D and pin 11 of U1420C, while the Channel B signal goes to pin 5 of U1420A and pin 6 of U1420B. In both TIME → B modes (variable clock or averaging), U1420D and U1420A are disabled with high voltage levels on pins 13 and 4, respectively. With U1420D and U1420A disabled, the input signals are routed to the TIME A - B Generator, U1321B. Both NOR gates, U1420D and U1420A, are also disabled for the TIME MANUAL mode. The Channel B NOR gate, U1420A, is disabled for the TOTALIZE A and FREQUENCY A modes; U1420D is not. Refer to the FUNCTION switch (S1810) logic pattern on the schematic for specific logic levels that enable or disable the remaining signal routing gates.

Time A → B Generator



Whenever a Reset signal appears on pin 13 of U1321 B, it sets pin 15 low and pin 14 high. The low on pin 15 enables U1420C on pin 10 and the high on pin 14 disables U1420B on pin 7. After reset, the Time A → B Generator waits for a positive transition (rising edge) on pin 11 of U1321B.

The first falling edge (after reset) on pin 11 of U1420C causes U1321 B to change state; pin 15 goes high, pins 14 and 10 go low. This change of state disables U1420C, enables U1420B, and sets pin 10 (D input) of U1321B low.

The Time A → B Generator remains in this high state until a falling edge (CH B signal) occurs on pin 6 of U1420B. The falling edge is inverted and clocks U1321B

on pin 11. The second rising edge causes U1321B to again change state. A low is clocked through to pin 15 and a high to pin 14; returning U1321B to its original state after reset. The circuit is now ready to accept another falling edge (CH A signal) on pin 11 of U1420C.

The end result of two changes of state for U1321 B is that a pulse width has been generated on pin 15 that goes high on the rising edge of the CH A signal and goes low on the rising edge of the CH B signal.

Signal Routing and Gate Generator



The purpose of the Signal Routing circuit is to route the CH A, CH B, Time → B, or Time Base (110 ns clock) signals to either the Gate Generator (pin 6 of U1410A), the ÷ N Circuit (schematic 6), or directly to the Count Input of the Decade Accumulators (schematic 4). In some modes of operation, the signals are routed to the ÷ N Circuit and then back to the Decade Accumulators or Gate Generator (via the emitter circuits of Q1330 or Q1320).

Refer to Fig. 3-1 for a typical DC 503A timing diagram and the sources of the count and measurement gate.

FREQUENCY A. The object of this mode is to count the CH A signal and use the Time Base to generate the Measurement Gate. For this mode, the CH A signal is routed through U1420D directly to the Decade Accumulators (U1221-9, schematic 4). The Time Base signal (100 ns clock) is routed through U1320C (pin 10 low) and out to the input of the ÷ N Circuit (U1310A-6, schematic 6). After the Time Base signal has been divided down (to 1 MHz, to 100 kHz, etc) it is routed back to the emitter of Q1320. This transistor is turned on in the saturated mode and passes the divided down signal, clocking the Gate Generator on pin 6 of U1410A and pin 11 of U1410B. Before a valid Measurement Gate can be generated the Gate Generator must have been reset (cleared) via U1320D.

The first positive transition of the ÷ N clock signal causes pin 15 of U1410B to go high. The second positive transition of the ÷ N clock causes pin 15 to go low and remain low for all other clock transitions until after U1410A and U1410B are reset by the clear pulse on pin 12 of U1320D.

The output on pin 14 of U1410B is the complement of the signal on pin 15. Pin 14 goes low and then high with the first and second clock transitions, remaining high until after reset (clear). The output on pin 14 is routed through and inverted by U1330B (pin 7 low). This positive gate is inverted again by U1220C before acting as the Measurement Gate for the Decade Accumulators.

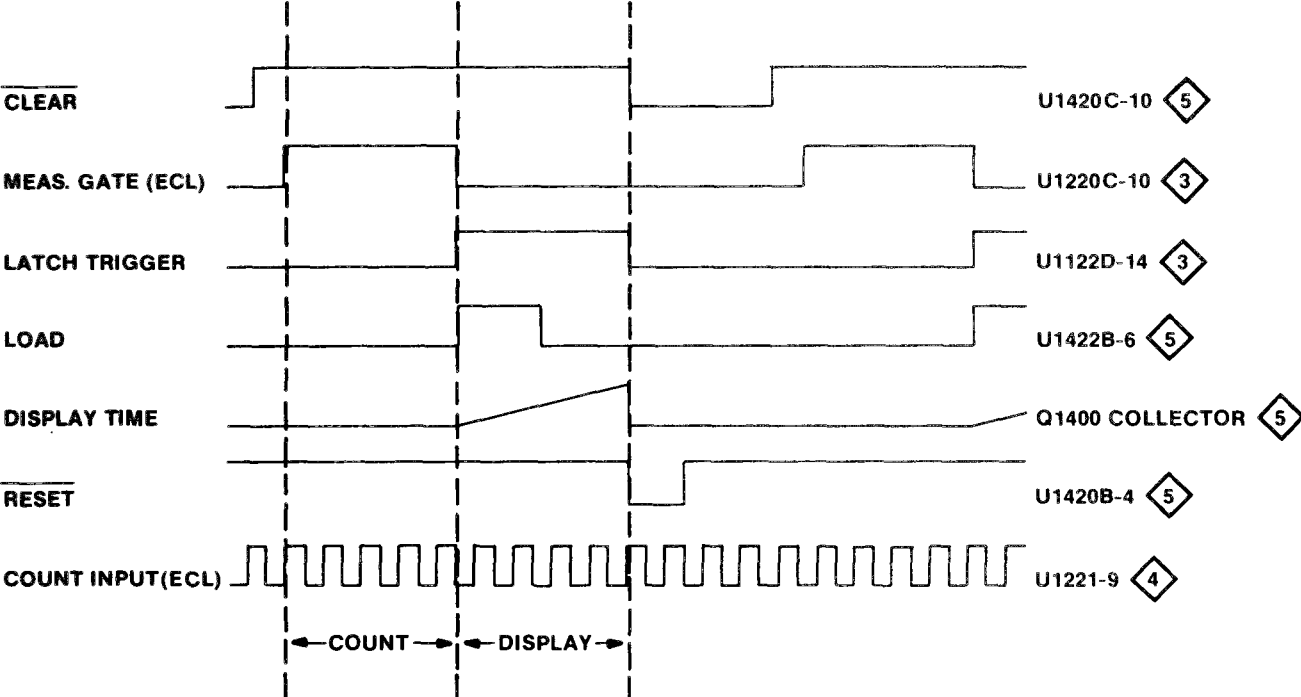

FUNCTION	COUNT SOURCE	GATE SOURCE
FREQUENCY A	CHANNEL A	DECADE DIVIDED 10 MHz TIME BASE
PERIOD B	DECADE DIVIDED 10 MHz TIME BASE	ONE PERIOD OF B INPUT
WIDTH B	DECADE DIVIDED 10 MHz TIME BASE	ONE WIDTH OF B INPUT
TIME A-B	DECADE DIVIDED 10 MHz TIME BASE	ONE INTERVAL FROM CHANNEL A INPUT TO CHANNEL B INPUT
PERIOD B (AVG)	10 MHz TIME BASE	N PERIODS OF B INPUT
WIDTH B (AVG)	10 MHz TIME BASE	N WIDTHS OF B INPUT
TIME A-B (AVG)	10 MHz TIME BASE	N INTERVALS FROM CHANNEL A INPUT TO CHANNEL B INPUT
EVENTS A DUR B (AVG)	CHANNEL A	N WIDTHS OF B INPUT
RATIO A/B (AVG)	CHANNEL A	N PERIODS OF B INPUT
TOTALIZE A	CHANNEL A	START/STOP SWITCH
TIME MANUAL	DECADE DIVIDED 10 MHz TIME BASE	START/STOP SWITCH

2971-02

Fig. 3-1. Typical DC 503A timing diagram.

TM 9-6625-474-14&P-3

The Gate Generator circuit also produces the Latch Trigger and a complementary Measurement Gate going to the Measurement Cycle Timing circuit on schematic 5. The operation of the Latch Trigger circuit is the same for all modes of operation that requires a Measurement Gate and will be described only once.

The generation of the Latch Trigger signal starts whenever pin 3 of U1410A goes high at reset (clear) for the Gate Generator. At reset, pin 13 of U1330D goes high and pin 15 goes low. This low is transmitted without inversion through buffer U1122D. Therefore, the Latch Trigger signal on pin 14 of U1122D goes low whenever the Gate Generator is cleared.

As soon as a positive clock edge occurs on pin 6 of U1410A, pin 3 goes low and pin 15 of U1330D goes momentarily high. However, pin 15 of U1410B is connected to pin 12 of U1330D and as soon as that signal goes high, pin 15 of U1330D goes low again. This action causes a momentary positive pulse immediately after first clocking the Gate Generator. This small pulse does not affect the operation of the instrument.

At the end of the Measurement Gate, pin 15 of U1410B goes low again. When this happens there will be a low on pin 12 and pin 13 of U1330D, causing a low to high transition on its output. It is the second low to high transition at the end of the Measurement Gate interval that produces the Latch Trigger and affects the Measurement Cycle Timing circuit.

PERIOD B (Variable Clock). For this mode, a Measurement Gate is generated from the Channel B input signal and the Time Base is counted (divided down or not). Since this is a single period measurement, the Time Base signal (10 MHz) is again routed to the $\div N$ Circuit via U1320C. During the single period the instrument counts 10 MHz, or 1 MHz, or 100 kHz, etc. The $\div N$ output again appears at the emitters of Q1330 and Q1320. For this mode it is Q1330 that is turned on in a saturated mode, allowing the divided down Time Base signal to pass on to the Decade Accumulators.

The Measurement Gate is generated from the CH B signal with U1420A enabled on pin 4 (low). The single period signal from CH B passes on through U1421C, then on through Q1321 because its base is low.

On the first rising edge of the single period, the start of the Measurement Gate is generated exactly the same as previously discussed under the FREQUENCY A mode of operation. On the next rising edge of the single period, the Measurement Gate is stopped with pin 14 of U1410B high and pin 15 low.

The gate signal generated on pin 14 of U1410B is again routed through and inverted by both U1330B and U1220C.

PERIOD B (Average). For this mode the Time Base signal is passed through U1330A directly to the Decade Accumulators. The Channel B signal is routed to the $\div N$ Circuit via U1420A, U1421C, and Q1331 (base is low). The divided down Channel B signal returns via Q1320 to clock the Gate Generator.

The first edge to clock the Gate Generator is the first edge of signal period. That edge is divided down by the $\div N$ Circuit to generate the second edge through Q1320 and terminate the Measurement Gate. The instrument is averaging over 10ⁿ number of Channel B signal periods to generate the Measurement Gate.

WIDTH B (Variable Clock). This mode of operation is exactly like PERIOD B (Variable Clock), except that the instrument counts the Time Base signal (divided by N, or not) during the positive portion or negative portion of the input signal period to Channel B. Whether the positive pulse width or negative pulse width is measured depends on the setting of the SLOPE switch, S1020. The Time Base signal passes through U1320C, out to the $\div N$ Circuit, back in through Q1330 and on to the Decade Accumulators.

The exclusive-OR gate, U1421C, along with NOR gate, U1430B, is used to generate a single width measurement. The Channel B signal appears on pin 14 of U1421C. Pin 15 is low at this time, causing U1421C to operate as a non-inverting buffer. When pin 14 goes from low to high, the output, pin 13, also goes from low to high. The positive transition is passed through Q1321 (base is low) and clocks the Gate Generator on the first rising edge of the Channel B input, starting the Measurement Gate (pin 14 of U1410B goes low).

Pin 7 of U1430B is at a logic low for this mode. When the Measurement Gate starts, pin 6 goes low and sets a high logic level on pin 15 of U1421C. During the Measurement Gate interval, U1421C operates as an inverter. The next falling edge from Channel B (end of the positive pulse) will cause another positive edge to clock the Gate Generator and terminate the Measurement Gate. The Measurement Gate is again routed through U1330B and U1220C, enabling the Decade Accumulators to count the Time Base during the positive pulse width.

WIDTH B (Average). This mode of operation is similar to Period B (Average), except that NOR gates U1430C and U1430A are involved in the process. With U1430C enabled on pin 10, the Channel B pulse width passes through U1430C to pin 4 of U1430A. The Channel B signal also

passes through U1421C, through Q1331, out to the ÷ N Circuit, and back through Q1320 to start the Gate Generator on the first edge. Pin 14 of U1410B goes low and sets pin 5 of U1430A low during the Measurement Gate interval (U1330B is disabled).

Pin 5 of U1430A stays low and keeps the logic gate enabled for the entire length of time equal to the number of pulse widths being averaged. The pulse width signals on pin 4 are gated through and inverted, appearing on pin 10 of U1220C. The Measurement Gate signal out of U1220C is alternating high and low for the total number of pulse widths being averaged. The Time Base count is being accumulated in the Decade Accumulators only during the times that the Measurement Gate is low on pin 14 of U1220C. At the end of the averaging cycle, pin 5 of U1430A goes high, disabling that gate, and preventing any more counting until the next reset (clear) pulse occurs.

TIME A → B (Average). This mode is the same signal routing as Width B (Average), except that the width is generated by the Time A → B Generator circuit. The rising edge of the Channel A signal starts the pulse width, and then the rising edge of the Channel B signal stops it.

EVENTS A DURING B (Average). Since it is required to count the number of events coming through Channel A during N intervals of the Channel B pulse width, U1330A is disabled on pin 5 to lock out the Time Base, and U1420D is enabled on pin 13 to allow the Channel A signals to pass through to the Decade Accumulators.

For this mode, the gate interval on pin 5 of U1430A lasts for 10ⁿ pulse widths and the Channel B signal on pin 4 is again logically anded through U1430A to pin 10 of U1220C (U1330B is disabled). The event count from Channel A is accumulated in the Decade Accumulators exactly like the Time Base was for the Width B (Average) mode.

RATIO A/B (Average). For this mode the instrument is essentially performing a period average with the Channel B signal generating the Measurement Gate (divided down or not, via the ÷ N Circuit), but the Channel A signal is being counted, rather than the Time Base.

The Time Base is disabled via both U1330A (pin 5 is high) and U1320C (pin 10 is high), and the instrument counts the Channel A signals passing through U1420D (Pin 13 is low). The Measurement Gate is passed through U1330B (pin 7 is low) and U1220C to allow the Channel A count to accumulate in the Decade Accumulators.

TOTALIZE A. Whether the instrument is in this mode or the Time Manual mode is dependent on the position of an

internal jumper P1020 (J1020) on schematic 9. Logic gate U1420D is enabled to allow counting the Channel A signals, while U1330C is enabled to allow the Measurement Gate, generated by the Start/Stop switch, S1311, or a Remote Start signal on P1900-26B, to pass through U1220C to the Decade Accumulators.

The Time Base is not used for this mode; logic gates U1330A and U1320C are disabled. The enabling of U1430C, Q1331, and Q1320 is redundant; the Measurement Gate is not generated via U1410B.

TIME MANUAL. For this mode, there are no Channel A or Channel B input signals. The Time Base signals are routed through U1320C to the ÷ N Circuit and back again via Q1330 to the Count Input of the Decade Accumulators. The Measurement Gate is generated and routed through U1330C exactly like the Totalize A mode.

÷ N Circuit 

The first decade counter in the ÷ N Circuit consists of U1310A, U1310B, U1411A, U1411B, U1300B, and associated ECL components. As the operator selects different positions of the AVGS/TIMING switch, S1010 on schematic 9, more and more of the remaining dividers become involved in the counting down process, generating a delay between the first and second clock pulses going to the Gate Generator circuit on schematic 3. The first decade counter is followed by U1400, a single decade counter, and the remaining dual decade counters, U1401, U1501, and U1610.

The clock input to the ÷ N Circuit occurs on pin 6 of U1310A and pin 5 of U1300A. The output from the ÷ N Circuit occurs at the wired-OR junction on pins 2 and 7 of U1300.

After reset, the first clock pulse edge at pin 6 of U1310A and pin 5 of U1300A passes through to pin 2 of U1300A (÷ N Output). The next clock edge will also pass through U1300A if N = 1, or it is going to be held off for the selected ÷ N countdown.

The ÷ N setting (1 through 10⁸ or 100 ns through 10 s) are identified by the logic state pattern for S1010 on schematic 6; the actual switch circuit is located on schematic 9. These settings enable or disable logic gates U1300C, U1510B, U1510A, U1510C, U1510D, U1511A, U1511B, or U1511D.

At reset (clear), all of the decade counters are set to a count of nine, causing all of the inputs to U1500 to be set high and enabling U1300A, Resistors R1302 and R1303

operate as TTL to ECL level shifters. As the first clock pulse on pin 5 of U1300A makes a transition from low to high, the output (pin 2) goes from low to high. Assuming that the first decade counter has also been reset, pins 9, 10, and 11 of U1300B are all low with its output (pin 7) also low. This low on pin 7 allows the first clock pulse to pass through U1330A. If the instrument is operating in the $\div 1$ mode, pin 5 of U1320A is held low. This ensures that the counters do not advance or change their "nines" state, allowing all of the succeeding clock edges to pass through U1300A.

For the $\div 10$ mode, pin 5 of U1320A is no longer held low and the first decade counter is no longer held reset. The first clock edge on pin 6 of U1310A passes on through U1300A. The first clock transition has also caused U1310A to change state, setting pin 9 of U1300B high. The output of U1300B and the wired-OR junction goes high and remains high for the next ten clock edges. After ten counts, the first decade counter is back to its original state, setting all three inputs to U1300B low. This causes the wired-OR junction to go low, allowing the eleventh clock edge to pass through U1300A. Thus, the first and eleventh clock edges causes the $\div N$ Output to go high.

The reason that the decade count does not continue past the first decade is that pin 5 of U1510B is held low and pin 6 of U1400 is held high. For $N = 10^2$ (100) pin 4 of U1401 is held reset (set to nine), but the first decade counter and U1400 are involved in the countdown process. The first clock edge through U1300A causes the $\div N$ Output to go high, and the 101st edge does the same. The second through one-hundredth clock edges are suppressed via the wired-OR junction and because the output of U1400 is changing, this keeps U1300A disabled until the 101st clock edge occurs.

In any of the averaging modes (PERIOD B, WIDTH B, TIME A \rightarrow B, EVENTS A DUR B, or RATIO A/B) and $N = 10$, it requires eleven periods of the selected mode to count ten periods. The first clock edge on pin 6 of U1310A advances the first decade counter, but it is desired to hold off the first clock edge out of the $\div N$ Circuit. Instead of setting pins 9, 10, and 11 of U1300B all low at reset (clear) for the averaging modes, pins 10 and 11 are reset low and pin 9 high; the first flip-flop, U1310A is set rather than reset. Anytime that the instrument is in an averaging mode and pin 5 of U1320A is not held low ($N = 1$), U1310A is set by the clear pulse via U1300C.

In the TOTALIZE A mode the $\div N$ Circuit and the internal Time Base are not used. In the TIME MANUAL mode, the Time Base signal is divided by N. In both modes the gate is generated by the START/STOP switch input to CR1222.

For all modes except TOTALIZE A and TIME MANUAL, the input to pin 3 of U1600B is at a high level. This causes

CR1220 to be forward biased, holding pin 9 of U1310A low and enabling that flip-flop to change state when clocked on pin 6. When the instrument is operating in the TOTALIZE A or TIME MANUAL mode, pin 3 of U1600B is held low, reverse biasing CR1220 and allowing the clock input to U1310A to be enabled and disabled by the START/STOP switch.

Also, for the TIME MANUAL and TOTALIZE A modes when the instrument is not dividing by one ($N = 1$), pins 12 and 13 of U1430D are both low. These low levels enable U1220D and disables U1320B. When the circuit is cleared by the ECL CLR signal on pin 5 of U1220D, U1411A becomes set, rather than reset; U1411A is normally reset for the other modes. This action also produces a small hold off interval for the TIME MANUAL mode; the first clock edge does not start the Gate Generator via U1300A. It takes at least two counts to get the Measurement Gate started in the TIME MANUAL mode.

Measurement Cycle Timing

NOTE

Refer to Signal Routing and Gate Generator (FREQUENCY A) discussion for a description of the circuit that generates the Latch Trigger signal. Also, see Fig. 3-1 for a typical timing diagram.

The Latch Trigger signal on P1630-1 (J1630-1) makes a positive transition when the Measurement Gate is terminated. Gate termination is indicated when a negative transition occurs on pin 3 of U1420A. The Latch Trigger signal goes to two places: pin 12 of U1423B and pin 11 of U1420D; therefore, two things are going to happen.

The negative transition on pin 13 of U1420D turns off Q1400, allowing C1400 to start charging toward +12 V through R1400, R1401, R1410, and the DISPLAY TIME switch, S1410. This produces a rising ramp voltage interval on the emitter of Q1300. Also, when triggered on pin 12, the one-shot multivibrator (U1423B) generates a positive pulse of approximately 50 ms duration on pin 10. The multi vibrator, along with U1420A, operate as a pulse stretcher circuit. The negative pulse out of pin 1 of U1420A causes the GATE light on the front panel to be illuminated during the active gating interval.

Pin 9 of U1423B also goes low when the multivibrator is triggered. Assuming that the RESET line is high, U1422D is enabled via pin 13. The rising edge on pin 12 of U1422D happens about 50 ms later and translates to a falling edge on pin 5 of U1423A, another one-shot multi vibrator. When U1423A is triggered by the falling edge on pin 5, a Load pulse (microseconds duration) is transmitted via U1422B

and U1621D to pin 1 of U1520 (schematic 7), telling the decade counting units to latch the accumulated count.

During the time that the GATE light and Load pulses were being generated, the ramp voltage on the emitter of Q1300 (a unijunction transistor) has been rising. Eventually, it will reach the voltage level necessary to turn on Q1300. When Q1300 turns on, C1400 discharges and a positive pulse of small duration is produced on pin 3 of UU1422A. The falling edge of that pulse triggers both U1421A and U1421B, generating two pulses (Reset and Clear).

The Reset pulse generated by U1421A and U1420B will be of shorter duration than the Clear pulse generated by U1421B and U1420C. The pulse on pin 4 of U1420B resets the U1520 internal decade counters (schematic 7). The pulse on pin 10 of U1420C resets all other ECL circuits and everything else. The CLR (Clear) pulse is of sufficient duration to allow for the setup times, minimum reset times, and a delay after reset before U1520 is ready to accept the next Count Input. After the CLR pulse terminates, the counter circuits are armed and ready to accumulate another count.

Transistor Q1700 and associated components comprise the power on reset circuit. At power on, Q1700 conducts and stays on for a time interval determined by the time constant value for R1700 and C1701.

Decade Accumulators



The 1st DCU circuit is located on schematic 4, the 2nd DCU on schematic 7. The Measurement Gate is applied to pins 7 and 6 of the first flip-flop, U1221, while the Count Input clocks U1221 on pin 9 for a divide by two operation.

The remaining flip-flops, U1120, U1121B, U1121A, and the feedback circuit through U1220B provides a divide by five operation.

The entire circuit on schematic 4 is a divide by ten decade accumulator with a bcd output code. The outputs of the flip-flops are translated from ECL levels to TTL levels by their associated buffer (amplifier) circuits, U122A, Q1133 and Q1132, U1122B, and U1122C. The 3.7 V reference for U1122A, B, and C is set by the voltage divider circuit, R1037 and R1036.

The four translated voltage levels out of the 1st DCU go to the first latch inputs of the 6-Decade Counter, U1520 (schematic 7), with the fourth bit value driving the 2nd DCU circuit, U1620 and associated components. Since

pins 12 and 1 of U1620 are hardwired, the 2nd DCU also divides by ten.

When the reset signal on pin 2 of U1620 goes high, all four outputs are set low and U1620 counts the negative edges that occur on pin 14. At the end of every 100 counts all of the binary inputs to U1520 should be low. Resistors R1624, R1623, R1622, and R1715 operate as pull up resistors to ensure that the D2 inputs for U1520 reach the 4.0 V level required for a logical "1" value.

6-Decade Ripple Through Counter



The 6-Decade Ripple Through Counter, U1520, increments on the negative edge of an internal clock. All six decades are reset to zero when the reset signal (pin 22) is held low for at least 4 μ s. An internal overflow flip-flop (pin 12) is reset at the same time. Reset must go high before the next valid count can be latched.

Eight decade latches are provided internally, two for storing the count from the 1st and 2nd DCU'S and six for internal counter output. All latches are loaded when pin 21 goes low for at least 4 μ s. Ripple through time is about 12 μ s.

The internal scan counter is driven by an internal oscillator whose frequency is determined by C1511 (pins 39 and 40). The counter scans from the most significant digit (MSD, pin 2) to the least significant digit (LSD, pin 9). Pins 2 through 9 are the digit strobe outputs (time slot lines TS1 through TS8).

A high level on the decimal point input (pin 10) resets a blanking flip-flop output (pin 11), causing the display to unblank. Pin 10 is brought high at the start of the digit strobe time slot that has the active decimal point.

An overflow flip-flop (pin 12) is set on the first negative transition occurring on the overflow input (pin 13). The most significant bit (MSB) output from the eighth decade (Pin 14) is used as overflow input.

Leading zero suppression is also provided internally. At the start of each scan counter cycle (MSD to LSD), the display is blanked (pin 11 is low) until a non zero digit or active decimal point is encountered. The display unblanks during LSD (TS8) time or whenever the overflow output (pin 12) is high.

Data output from U1520 appears on pins 20, 19, 18, and 17, in a multiplexed bcd format. The internal scan counter causes the proper decade count to appear on these lines at the same time as its corresponding digit strobe (time slot)

is made active. The bcd output data is demultiplexed via the time slot lines driving the eight LED's in the display (schematic 8). The bcd output codes area also converted to seven segment information by U1610.

Decimal Point and Annunciator Encoder



Two programmable read only memory (PROM) devices, U1200 and U1300, are used to accept the setting information from the FUNCTION and AVGS/TIMING switch circuits on schematic 9. This information lets the PROMS know what function and timing point the instrument is in so that they can, in turn, select which decimal point and annunciator should be illuminated. The annunciators are the GHz/nSEC, MHz/ μ S, KHz/mSEC, and Hz/SEC indicator lights.

The decimal point data from the PROMS is fed to pins 9, 10, and 11 of U1400, a one-of-eight selector/multiplexer. Integrated circuit U1400 is used as a single pole, seven position switch that switches the proper time slot pulse (TS1 through TS7) to the decimal point scanned lines, pins 6 and 5 of U1400. Pin 5 will have a positive pulse and pin 6 a negative pulse for the decimal point scanned information.

Decimal point information is not displayed in the TOTALIZE A mode. Pin 9 of U1422C and pin 13 of U1612F are set low, and pin 10 of U1422C is set high for this mode. This coding deselected and turns off both PROMS at pin 15 (high) and deselected U1400 at pin 7 (high).

There are four sets of decimal point and annunciator information contained in the two PROMS. These four sections are selected by the ADE and ADF lines as shown in Table 3-1.

Table 3-1
PROM SELECTION CODE

Mode	ADE J1430-7	ADF J1430-4	PROM Selected
FREQUENCY A	0	0	U1200
PERIOD B, WIDTH B, TIME A → B (AVGS)	0	1	U1300
RATIO A/B, EVENTS A DUR B (AVGS)	1	0	U1200
PERIOD B, WIDTH B, TIME A → B (TIMING)	1	1	U1300
TOTALIZE A, TIME MANUAL	1	1	U1300 for TIME MANUAL only.

Display



The eight digit LEDs are common cathode displays, with the time slot pulses (TS1 through TS8) scanning pin 6 on each digit; DS1002 is the most significant digit and DS1305 is the least significant digit. All of the seven segment and decimal point information is paralleled. For leading zero suppression during the scanning cycle, the display is blanked (seven segment information is missing) until the first non-zero digit or decimal point is encountered.

The GATE and OVERFLOW lights, CR1011 and CR1012, are driven by current limit resistors, R1011 and R1012. A single current limiting resistor, R1009, is used for the four annunciator lights because only one of them is illuminated at any given time.

Switching Logic (FUNCTION, AVGS/TIMING)



The FUNCTION switching logic for S1810 is on the A12 Aux board (top half of schematic), while the AVGS/TIMING switching logic for S1010 is on the A14 Main board (lower half of schematic). A simplified logic pattern for S1810 is located on schematic 3 and the logic pattern for S1010 is located on schematic 6.

The switch wafer positions for the FUNCTION switch are drawn in-line, horizontally with one wafer position offset slightly to indicate reset between detents. The same type of pattern is drawn for the AVGS/TIMING switch, S1010.

Integrated circuits U1611D and U1611B are used to reset the Time A → B Generator when either measurement mode for that function is activated or whenever the clear pulse occurs on pin 6 of U1611B.

Pin 8 of U1600D is set low for the modes that use the 10 MHz Time Base clock as the direct Count Input to the Decade Accumulators. Pin 10 of U1611C is set low for those modes that use the Channel A signal as the direct Count Input. The remaining logic gates, along with the actual grounded positions of the FUNCTION switch, control the signal paths discussed under the Block Diagram discussion and the discussion for the Signal Routing and Gate Generator circuits.

The ADE control line (U1611A, pin 3) and the ADF line (U1600E, pin 10) are used to address the two PROMS in the Decimal Point and Annunciator Encoder circuits (see Table 3-1).

The tenth position of the FUNCTION switch is used for the TOTALIZE A and TIME MANUAL modes. The desired

mode is selected by the user changing the position of P1020 relative to the pins on J1020. This jumper is located on the A12 Aux board. Diode CR1021 is turned on in the TIME MANUAL mode to set pin 13 of U1601C low; activating the proper Signal Routing circuits on schematic 3.

Time Base

The standard 10 MHz clock frequency is generated by Q1701 and Y1810 operating as a Colpitts oscillator, with small frequency changes provided by the adjustment of C1715. The power supply for this circuit is regulated at 10 V by Zener diode VR1710.

The output of the standard time base circuit drives the base of Q1720, operating as a buffer amplifier. The output of Q1720 is passed through U1621 E where three resistors, R1731, R1732, and R1735 translate the time base signal into ECL levels that operate the circuits on the Aux board.

The Option 1 Time Base circuit, Y1710, uses an 18 V oven for temperature control. The 18 V is derived from another three terminal regulator, U1800, using feedback resistors R1801 and R1803 to control the 18 V on pin 3 of Y1701.

Internal jumper connections P1710 and P1720 allow the user to select an external 10 MHz time base or TTL clock via the rear interface.

When the instrument is equipped with the optional time base, all of the standard time base components are removed.

Power Supplies

Integrated circuit U1831 supplies the reference voltage for the +5 V and -12 V power. The +5 V power is derived from the +11.5 Vdc supply in the power module, while the -12 V power is derived from the +33.5 Vdc supply. The +12 V power is derived from the three terminal regulator,

U1 830, connected to the +33.5 Vdc supply. Reverse polarity protection for the three supplies is provided by CR1732, CR1733, and CR1730.

The +5 V, -12 V, and +12 V power is connected from the Main board to the Aux board via P1630 (pins 7,8,9, and 10) where decoupling networks are provided. The +5 V is divided down to about 3.3 V on the base of Q1032 and reflected as +2.7 V on the emitter. Voltage feedback for this regulator is provided by Q1030 and Q1020. The main purpose of Q1020 is to sink the current coming from all of the 150 Ω ECL terminations used throughout the various logic circuits.

The +7 V reference from U1831 on the Main board originates on pin 6 and then divided down to +5 V by R1826 and R1827. The +5 V load current flows through R1733 (the current limiting resistor), through the npn series pass transistor in the power module, and through F1830 to the +11.5 Vdc supply. The load voltage is regulated within design limits by varying the voltage on the base of the series pass transistor. If the load current exceeds about 2 A, the voltage drop across R1733 becomes great enough to limit the current by causing the base of the series pass transistor to go more negative with respect to its emitter. This over current voltage is sensed at pins 2 and 3 of U1831. Feedback input to U1831 occurs on pin 4, with frequency compensation provided by C1830.

The -12 V supply is referenced to the +7 V on pin 6 of U1831 via R1825. The voltage level at the junction of R1825 and R1730 is near 0 V.

Should the -12 V supply go slightly more positive, the voltage at the base of Q1724 goes more positive, increasing the current through Q1723 and R1820. This causes the base of Q1721 to go more positive and increases the current through the pnp series pass transistor in the power module. This increased current flow lowers the -12 V until the correct voltage is reached. If the load current from this supply exceeds about 220 mA, the voltage drop across R1721 becomes large enough to cause Q1722 to conduct, thereby reducing and limiting the current through the pnp series pass transistor.

SECTION 4

CALIBRATION**PERFORMANCE CHECK PROCEDURE****Introduction**

This procedure checks the electrical performance requirements as listed in the Specification section in this manual. Perform the Adjustment Procedure if the instrument fails to meet these checks. In some cases, recalibration may not correct the discrepancy; circuit troubleshooting is then indicated. Also, use this procedure to determine acceptability of performance in an incoming inspection facility.

Calibration Interval

To ensure instrument accuracy, check the calibration every 1000 hours of operation or at a minimum of every six months if used infrequently.

Services Available

Tektronix, Inc. provides complete instrument repair and adjustment at local field service centers and at the

factory service center. Contact your local Tektronix field office or representative for further information.

Test Equipment Required

The following test equipment (or equivalent) listed in Table 4-1 is suggested to perform the Performance Check and Adjustment Procedure.

WARNING

Dangerous potentials exist at several points throughout this instrument. Caution must be exercised. When the instrument is operated with the covers removed, do not touch exposed connections or components.

Table 4-1

LIST OF TEST EQUIPMENT REQUIREMENTS

Description	Performance Requirements	Application		Example
		Performance Check	Adjustment Procedure	
Power Module		X	X	TEKTRONIX TM 503 or TM 504
Oscilloscope Mainframe	Bandwidth, dc to 200 MHz	X	X	TEKTRONIX 7704A
Vertical plug-in	Bandwidth, dc to 200 MHz	X	X	TEKTRONIX 7A16
Horizontal plug-in	Fastest sweep rate 5 mV, 10 ns	X	X	TEKTRONIX 7B80
Leveled Sinewave Generator	Frequency range to 125 MHz; amplitude range to 5 V p-p, 50 Ω	X		TEKTRONIX SG 503
Function Generator	Range, sinewave 10 Hz to 1 MHz; offset +2.5 V level	X	X	TEKTRONIX FG 501
Pulse Generator	Range to 125 MHz, ±1 V, 50 Ω	X		TEKTRONIX PG 502
Digital Multimeter	Range $\geq \pm 20$ Vdc, 4 1/2 digits	X	X	TEKTRONIX DM 501A
50 Ω 10X attenuator	Bnc connectors	X		Tektronix Part No. 011-0059-02
50 Ω Feedthrough Termination	Bnc connectors	X		Tektronix Part No. 011-0049-01
BNC Female to Dual Banana		X		Tektronix Part No. 103-0090-00
Tip jack to bnc cable		X		Tektronix Part No. 175-1178-00
Coaxial, 50 Ω Precision, 36 inch	Bnc connectors	X	X	Tektronix Part No. 012-0482-00
VARIAC		X	X	
WWVB (60 kHz) Receiver/ Frequency Standard	(1 MHz output)	X	X	SPECTRACOM CORP Type 8161
Dual bnc connector		X		Tektronix Part No. 067-0525-01

Preliminary Control Settings

7000 Series Oscilloscope

POWER	On
FOCUS	} as desired for a } well-defined display
INTENSITY	
VERTICAL MODE	LEFT
HORIZONTAL MODE	B
B TRIGGER SOURCE	VERT MODE

Vertical Plug-in

VOLTS/DIV	.2
VARIABLE	in
BANDWIDTH	FULL
POLARITY	+ UP
AC-GND-DC	DC
POSITION	centered display

Horizontal Plug-in

TRIGGERING	
MODE	P-P AUTO
COUPLING	AC
SOURCE	INT
POSITION	as desired
TIME/DIV	20 nS
VARIABLE	in
MAG	X1 (in)

DC 503A

FUNCTION	as indicated
TIMING	as indicated
DISPLAY TIME	ccw
CH A and CH B	
LEVEL	midrange
SLOPE	+ (out)
ATTEN	x1 (out)
COUPL	DC (out)
SOURCE	EXT (out)

Sinewave Generator

FREQUENCY RANGE (MHz)	100—250
OUTPUT AMPLITUDE	1.00
FREQUENCY VARIABLE	125
AMPLITUDE MULTPLIER	X.1

TIME BASE CHECKS

1. Check Oscillator Frequency (Standard time base and Option 1)

NOTE

The time base accuracy is a function of temperature and time. The temperature stability for the standard time base is ± 5 ppm (0° C to 50° C) with an aging rate of ± 1 ppm/year.

After one year of operation (since the time base was calibrated), the 1 MHz WWVB frequency standard should read 1000.0000 ± 61 counts for any temperature between 0° C to 50° C. The ± 61 counts are determined by ± 50 counts, due to temperature (± 5 ppm); ± 10 counts due to aging (± 1 ppm); and ± 1 count to synchronization error. After this check is completed, the user should determine if a time base re-calibration is required.

a. Set the DC 503A FUNCTION switch to PERIOD B (AVGS) and set the AVGS switch to 10^6 .

b. Connect a coaxial cable from the WWVB Standard output to the DC 503A B INPUT.

c. Adjust the DC 503A CH B LEVEL control for a stable readout on the DC 503A display.

d. Check—that the DC 503A readout is within 999.9939 and 1000.0061 (± 6.0 ppm, ± 1 count).

e. To check for Option 1 time base oscillator frequency, change the DC 503A AVGS switch to 10^7 .

f. Adjust the DC 503A CH B LEVEL control for a stable readout on the DC 503A display.

g. Check—that the DC 503A readout is within 999.99879 and 000.00121 with the display OVERFLOW light on (± 1.20 ppm, ± 1 count).

CH A AND CH B CHECKS

2. Check CH A Input Frequency Range and Sensitivity, X1 and X5 Attenuation, dc coupled (0 Hz to ≥ 125 MHz). Refer to Fig. 4-1 check set-up.

a. Change the DC 503A FUNCTION switch to FREQUENCY A and the TIMING switch to 10 ms.

b. Connect the DC 503A A SHAPED OUT signal to the Vertical Plug-in INPUT connector using the tip jack-to-bnc connector (black terminal to COMMON).

c. Connect the sinewave generator OUTPUT to the DC 503A CH A INPUT using the coaxial cable and the 50 Ω termination.

d. Adjust the DC 503A CH A LEVEL control for a stable display on the DC 503A and oscilloscope.

e. CHECK—that the DC 503A readout indicates approximately 125.0000 (MHz) with the display MHz/μSEC illuminated.

f. Press (in) the X5 DC 503A CH A ATTEN.

g. Change the sinewave generator OUTPUT AMPLITUDE to 5.00.

h. Adjust the DC 503A CH A LEVEL control for a stable display on the DC 503A and the oscilloscope.

i. CHECK—that the DC 503A readout indicates approximately 125,000 (MHz) with the display MHz/μSEC illuminated.

3. Check Totalize A and Time Manual (0 to 125 MHz)

a. Turn off the power module. Remove the DC 503A.

b. Change the TIME MAN UAL/TOTALIZE jumper, J1020 (located on rear of the Auxiliary board) to the TOTALIZE position. Refer to Adjustment Locations in the pullout pages of this manual.

c. Re-insert the counter into the power module.

d. Turn on the power module.

e. Set the DC 503A FUNCTION switch to TOTALIZE and press the START/STOP pushbutton to START (in position).

f. CHECK—for the total maximum count readout on the DC 503A display (at end of count, display OVERFLOW may light).

g. Press the START/STOP pushbutton to STOP (out position).

h. Turn off the power module, remove the DC 503A and change the TIME MAN UAUTOTALIZE jumper (J1020) to the TIME MANUAL position.

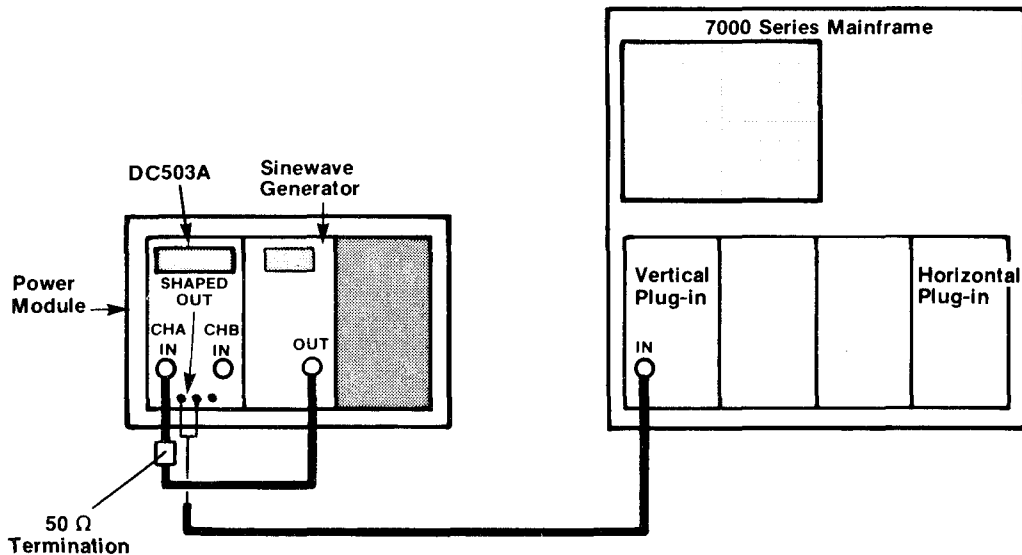

2971-03

Fig. 4-1. Check set-up for the high frequency sensitivity using X1 and X5 attenuation.

i. Re-insert plug-in into the power module.

j. To check the Time Manual, press the START/STOP pushbutton to START (in position).

k. CHECK-the DC 503A display readout (in seconds) for the advancing count.

l. Press the START/STOP pushbutton to STOP (out position).

4. Check CH A Input Sensitivity, X5 and X1 Attenuation (20 mV rms sine wave to 100 MHz). Refer to Fig. 4-1 check set-up.

a. Change the sinewave generator FREQUENCY VARIABLE to 100 and the OUTPUT AMPLITUDE control to 2.80.

b. Change the DC 503A FUNCTION switch to FREQUENCY A and adjust the DC 503A CH A LEVEL control for a stable display on the DC 503A and oscilloscope.

c. CHECK—that the DC 503A readout indicates approximately 100.0000 (MHz) with the display MHz/ μ SEC illuminated.

d. Set the DC 503A CH A ATTEN switch to X1 (out position).

e. Change the sinewave generator OUTPUT AMPLITUDE control to .56.

f. Adjust the DC 503A CH A LEVEL control for a stable display on the DC 503A and oscilloscope.

g. CHECK-that the DC 503A readout indicated approximately 100,000 (MHz/ μ SEC illuminated).

5. Check CH B Input Frequency Range and Sensitivity, X1 and X5 Attenuation, dc coupled (0 Hz to 100 MHz). Refer to Fig. 4-1 check set-up.

a. Remove the cable from the DC 503A CH A INPUT connector and connect to the CH B INPUT. Remove the A SHAPED OUT connector and connect to the B SHAPED OUT connector (black terminal to COMMON).

b. Set the DC 503A AVGS switch to 10⁶ and FUNCTION to PERIOD B AVGS.

c. Adjust the DC 503A CH B LEVEL control for a stable display on the DC 503A and oscilloscope.

d. CHECK-that the DC 503A readout indicates approximately 10.0000 (nSEC) with the display GHz/nSEC illuminated.

e. Set the DC 503A CH B ATTEN switch to X5 (in position).

f. Change the sinewave generator OUTPUT AMPLITUDE control to 2.80.

g. Adjust the DC 503A CH B LEVEL control for a stable display on the DC 503A and oscilloscope.

h. CHECK-that the DC 503A readout indicated approximately 10,000 (nSEC) with the display GHz/nSEC illuminated.

i. CHECK-that the DC 503A readout indicates approximately 10.0000 (nSEC) with the display GHz/nSEC illuminated.

6. Check CH B Input Sensitivity, X5 and X1 Attenuation (35 mV rms sine wave to 125 MHz). Refer to Fig. 4-1 check set-up.

a. Change the sinewave generator OUTPUT AMPLITUDE to 5.00 and FREQUENCY VARIABLE to 125.

b. Adjust the DC 503A CH B LEVEL control for a stable display on the DC 503A and oscilloscope.

c. CHECK-that the DC 503A readout indicates approximately 8.0000 (nSEC) with the display GHz/nSEC illuminated.

d. Change the sinewave generator OUTPUT AMPLITUDE to 1.00.

e. Set the DC 503A CH B ATTEN switch to X1 (out position).

f. Adjust the CH B LEVEL control for a display on the DC 503A and oscilloscope.

TM 9-6625-474-14&P-3

g. CHECK--that the DC 503A readout indicates approximately 8,000 (nSEC) with the display GHz/nSEC illuminated.

7. Check the CI-f A Input Frequency Range, X1 ac coupled (10 Hz). Refer to Fig. 4-2 check set-up and the preliminary control settings with the following addition:

Function Generator

FREQUENCY Hz	10
MULTIPLIER	1
FUNCTION	 (sine)
OUTPUT	ccw

a. Turn the power module off. Disconnect the sinewave generator OUTPUT cable and remove the sinewave generator plug-in.

b. Insert the function generator plug-in and set the controls as listed above. Turn on the power module.

c. Disconnect the vertical plug-in INPUT connector (B SHAPED OUT signal).

d. Remove the DC 503A CH B cable connection. Insert the 10X attenuator with the 50 Ω termination onto the vertical plug-in INPUT. Connect the coaxial cable from the 10X attenuator to the function generator OUTPUT.

e. Set the DC 503A CH A and CH B ATTEN to X1 and the CH A and CH B COUPL to DC.

f. Set the vertical plug-in VOLTS/DIV to 10 mV and the AC-GND-DC switch to GND.

g. Adjust the vertical plug-in POSITION control to center the trace on the oscilloscope crt display.

h. Change the vertical plug-in AC-GND-DC switch to DC.

i. Adjust the function generator OFFSET control to center the displayed signal on the crt.

j. Adjust the function generator AMPLITUDE control for five graticule divisions of signal on the crt display (50 mV p-to-p).

k. Change the DC 503A TIMING switch to 1 s and the FUNCTION switch to FREQUENCY A.

Fig. 4-2. Check set-up for low frequency ac and dc sensitivity.

l. Move the vertical plug-in INPUT connection to the DC 503A CH A INPUT and re-connect the A SHAPED OUT signal to the vertical plug-in INPUT. Change the vertical plug-in VOLTS/DIV switch to .2. Adjust the CH A LEVEL for a stable readout on the DC 503A and oscilloscope.

m. CHECK-that the DC 503A readout indicates approximately 0.010 (kHz) with the display kHz/mSEC illuminated.

n. Set the DC 503A CH A COUPL switch to AC.

o. Set the function generator OFFSET control fully clockwise.

p. CHECK-that the DC 503A readout indicates approximately 0.010 (kHz) with the display kHz/mSEC illuminated.

q. Set the DC 503A FUNCTION switch to PERIOD B and the TIMING to 10 μ s.

r. Move the DC 503A CH A connection and reconnect to the CH B connector. Remove the A SHAPED OUT connector and connect to the B SHAPED OUT (black terminal to COMMON). Adjust the CH B LEVEL control for a stable readout on the DC 503A and oscilloscope.

s. The oscilloscope crt display is a squarewave.

t. CHECK-that the DC 503A readout indicates approximately 100.00 (mSEC) with the display kHz/mSEC illuminated.

8. Check the CH B Input Frequency Range, X1 ac coupled (10 Hz). Refer to Fig. 4-2 check set-up.

a. Set the DC 503A CH B COUPL switch to AC.

b. Adjust the DC 503A CH B LEVEL control for a stable readout on the DC 503A and oscilloscope.

c. CHECK-that the DC 503A readout indicates approximately 100.00 (mSEC) with the display kHz/mSEC illuminated.

d. Set the function generator OFFSET control fully counterclockwise.

e. The oscilloscope crt display is a squarewave.

f. CHECK-that the DC 503A readout indicates approximately 100.00 (mSEC) with the display kHz/mSEC illuminated.

MINIMUM PULSE WIDTH CHECKS

9. Check the Input Sensitivity X1 Attenuation (100 mV p-to-p pulse at minimum pulse width of 4 ns to 125 MHz). Refer to Fig. 4-3 check set-up and preliminary control settings with the following exceptions:

Vertical Plug-in

VOLTS/DIV	50 mV
VARIABLE	in
BANDWIDTH	FULL
POLARITY	+ UP
AC-GND-DC	GND
POSITION	centered display

Horizontal Plug-in

TIME/DIV	2 ns
----------	------

Pulse Generator

PULSE DURATION	square wave
VARIABLE	ccw
PERIOD	4 ns
VARIABLE	ccw
BACK TERM	out
COMPLEMENT	out

DC 503A

FUNCTION	FREQUENCY A
TIMING	100 μ s
DISPLAY TIME	ccw
CH A and CH B	
SLOPE	+
ATTEN	X1
COUPL	DC
SOURCE	EXT

a. Turn off the power module and disconnect the function generator coaxial cable. Remove the function generator plug-in. Insert the pulse generator plug-in and turn on the power module.

b. Connect coaxial cable to the pulse generator OUTPUT.

TM 9-6625-474-14&P-3

c. Adjust the vertical plug-in POSITION control to center the trace on the crt. Change the AC-GND-DC Switch to DC.

d. Remove the DC 503A B SHAPED OUT connection from the vertical plug-in INPUT.

e. Remove the DC 503A CH B INPUT coaxial cable with 10X attenuator and connect to the vertical plug-in INPUT.

f. Adjust the pulse generator OUTPUT (VOLTS) LOW LEVEL control to position the bottom edge of the displayed squarewave to the center of the crt graticule.

g. Adjust the pulse generator OUTPUT (VOLTS) HIGH EDGE control for two divisions of display on the crt (100 mV p-top).

h. Adjust the pulse generator PERIOD VARIABLE control for a period of 8 ns (4 div).

i. Move the vertical plug-in INPUT connection to the DC 503A CH A INPUT and connect the A SHAPED OUT signal to the vertical plug-in INPUT. Change the vertical plug-in VOLTS/DIV switch to .2.

j. Adjust the DC 503A CH A LEVEL control for stable display on the DC 503A and oscilloscope.

k. CHECK-that the DC 503A readout indicates approximately 125.00 (MHz) with the display MHz/ μ SEC illuminated.

m. Move the DC 503A A SHAPED OUT connector to the B SHAPED OUT (black terminal to COMMON) and move the CH A INPUT connection to the CH B INPUT.

n. Set Function Switch to period B (Avgs). Set Avgs to 10^6 .

o. CHECK-that the DC 503A readout indicates approximately 8,000 (nSEC) with the display GHz/nSEC illuminated.

10. Check Period B Minimum Pulse Width (4 ns at 100 mV peak-to-peak).

a. Set the DC 503A FUNCTION switch to PERIOD B (no AVGS).

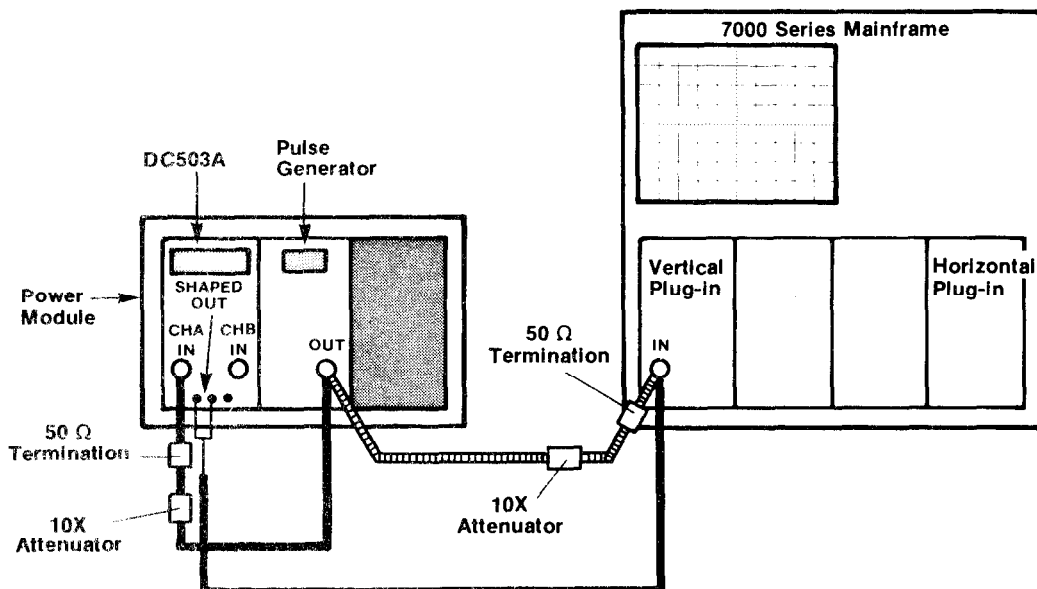

2971-05

Fig. 4-3 Check set-up for minimum pulse width signals.

b. CHECK-the displayed GATE light blinks and the display readout is 0.0 (SEC) ± 1 count with the display Hz/SEC illuminated.

11. Check RATIO A/B Minimum Pulse Width (4 ns at 100 mV peak-to-peak).

a. Set the DC 503A FUNCTION switch to RATIO A/B.

b. CHECK-the displayed GATE light blinks and the display readout is 0.000000 ± 1 count (no annunciator lights).

12. Check the Input Sensitivity X1 Attenuation (60 mV p-to-p pulse at minimum pulse width of 5 ns to 100 MHz). Refer to Fig. 4-3 check set-up and control settings as shown in step 9.

a. Remove the DC 503A B SHAPED OUT connection from the vertical plug-in INPUT.

b. Change the coaxial cable (with the 10X attenuator) from the DC 503A CH B INPUT to the vertical plug-in INPUT.

c. Change the vertical plug-in VOLTS/DIV to 20 mV.

d. Adjust the pulse generator OUTPUT (VOLTS) Low LEVEL control to position the bottom edge of the displayed Squarewave to the center of the CM graticule.

e. Adjust the pulse generator OUTPUT (VOLTS) HIGH EDGE control for three divisions of display (60 mv p-to-p) on the crt.

f. Change the vertical plug-in VOLTS/DIV to 0.1 and adjust the pulse generator PERIOD VARIABLE for a period of 10 ns (5 divisions).

g. Move the vertical plug-in INPUT connection to the DC 503A CH A INPUT and connect the A SHAPED OUT signal to the vertical plug-in INPUT.

h. Adjust the DC 503A CH A LEVEL control for a stable display on the DC 503A and oscilloscope.

i. CHECK-that the DC 503A readout indicates approximately 100.00 (MHz) with the display MHz/ μ SEC illuminated.

j. Set the DC 503A FUNCTION switch to PERIOD B (AVGS) and the AVGS switch to 10^6 .

k. Move the DC 503A A SHAPED OUT connector to the B SHAPED OUT (black terminal to COMMON) and move the CH A INPUT connection to the CH B INPUT.

l. Adjust the DC 503A CH B LEVEL control for a stable display on the DC 503A and oscilloscope.

m. CHECK-that the DC 503A readout indicates approximately 10.000 (nSEC) with the display GHz/nSEC illuminated.

13. Check the Width B (AVGS) Minimum Pulse Width (5 ns).

a. Set the DC 503A FUNCTION switch to WIDTH B (AVGS).

b. CHECK-the displayed GATE light blinks and the readout indicates approximately 5.0000 (nSEC) with the display GHz/nSEC illuminated.

14. Check the Events A During B Minimum B Pulse Width (5 ns).

a. Set the DC 503A FUNCTION switch to EVENTS A DUR B.

b. CHECK-the displayed GATE light blinks and the display readout is 0.000000 ± 1 count (no annunciator lights).

15. Check the Width B (no AVGS) Minimum Pulse Width (20 ns).

a. Change the DC 503A FUNCTION switch to PERIOD B (AVGS).

b. Change the pulse generator PERIOD to 10 ns and adjust PERIOD VARIABLE for a DC 503A display readout of approximately 40.0000 (nSEC) with the display GHz/nSEC illuminated.

c. Change DC 503A FUNCTION switch to PERIOD B (no AVGS).

TM 9-6625-474-14&P-3

d. CHECK-the displayed GATE light blinks and the display readout is 0.0 (SEC) ± 1 count with the display Hz/SEC illuminated.

TWO CHANNEL FUNCTION CHECKS

16. Check Time A \rightarrow B Single Shot Minimum Time Interval and Time A \rightarrow B Average Minimum Time interval (12.5 ns). Refer to Fig. 4-4 check set-up and the following control settings:

DC 503A

FUNCTION	FREQUENCY A
TIMING	1 ms
DISPLAY TIME	ccw
CH A	
LEVEL	midrange
SLOPE	+ (out position)
ATTEN	XI (out position)
COUPL	DC (out position)
SOURCE	EXT (out position)
CH B	
LEVEL	midrange
SLOPE	- (in position)
ATTEN	XI (out position)
COUPL	DC (out position)
SOURCE	EXT (out position)

Pulse Generator

PERIOD	10 ns
OUTPUT (VOLTS)	
LOW LEVEL	-1
HIGH LEVEL	1
BACK TERM	OUT

a. Connect 50 Ω terminations to both DC 503A CH A and CH B INPUTS.

b. Connect the dual input connector to the 50 Ω termination on the DC 503A INPUTS,

c. Connect the coaxial cable from the pulse generator OUTPUT to the dual input connector.

d. Connect the tip jack-to-bnc connector from the DC 503A A SHAPED OUT (black terminal to COMMON) to the vertical plug-in.

e. Adjust the DC 503A CH A LEVEL control for a squarewave display on the oscilloscope crt.

f. Adjust the pulse generator PERIOD VARIABLE control for a DC 503A display readout of approximately 40.000 (MHz) with the display MHz/ μ SEC illuminated.

g. Move the DC 503A A SHAPED OUT connection to the B SHAPED OUT.

h. Adjust the DC 503A CH B LEVEL control for a squarewave display on the crt.

i. Set the DC 503A FUNCTION switch to TIME A → B (AVGS) and the AVGS switch to 10⁶.

j. CHECK-that the DC 503A display readout indicates between 8.5000 and 16.5000 (12.5 ns ±4 ns) with the display GHz/nSEC illuminated.

k. Change the DC 503A FUNCTION switch to TIME A → B (TIMING).

l. CHECK-the displayed GATE light blinks and the display readout is 0.0 (SEC) ±1 count with the display Hz/SEC illuminated.

17. Check Events A during B

a. Change the DC 503A FUNCTION switch to EVENTS A DUR B.

b. CHECK-the DC 503A display readout indicates 1.000000 ±1 count (.999999 to 1.000001).

18. Check Ratio A/B

a. Change the DC 503A FUNCTION switch to RATIO A/B.

b. CHECK-the DC 503A display readout indicates 1.000000 ±1 count (.999999 to 1.000001) (no annunciator lights).

TRIGGER LEVEL CHECKS

19. Check Trigger Level Range, ±3.5 V. Refer to Fig. 4-5 check set-up and preliminary control settings with the following exceptions:

DC 503A	
FUNCTION	FREQUENCY A
TIMING	1 ms
COUPL (CH A and CH B)	AC

Digital Multimeter

RANGE 20 DC VOLTS

a. Turn off the power module and disconnect the pulse generator OUTPUT connection. Remove the pulse generator plug-in.

b. Insert the digital multimeter plug-in. Turn on the power module.

c. Connect a tip jack-to-bnc cable from the DC 503A A TRIG LEVEL to a bnc female-to-bnc banana connector and connect to the digital multi meter INPUT.

d. Adjust the DC 503A CH A LEVEL control fully counterclockwise.

e. CHECK-that the digital multi meter readout indicates between -3.500 and -10.000.

f. Adjust the DC 503A CH A LEVEL control fully clockwise.

g. CHECK-that the digital multimeter readout indicates between +3.500 and +10.000.

h. Change the DC 503A CH A connections to the CH B (with appropriate control settings) and repeat steps 19d through 19g.

20. Check A Trigger Level Output Accuracy (±20 mV ±0.5% of reading). Refer to Fig. 4-5 check set-up and control settings in step 19 with the following exceptions:

Function Generator

FREQUENCY RANGE 10⁵
 FREQUENCY VARIABLE 1
 FUNCTION  (sine)
 OUTPUT AMPLITUDE min (ccw)

Vertical Plug-in

VOLTS/DIV 50 mV

Horizontal Plug-in

TIME/DIV 1 μS

TM 9-6625-474-14&P-3

a. Turn off the power module. Insert the function generator. Turn on the power module.

b. Connect a tip jack-to-bnc cable from the DC 503A A SHAPED OUT to the vertical plug-in INPUT.

c. Remove the DC 503A B TRIG LEVEL connection (tip jack-to-bnc cable). Connect the digital multimeter INPUT through the $50\ \Omega$ termination to the function generator OUTPUT,

d. Adjust the function generator OFFSET control for a displayed reading between +2.450 and +2.550 on the digital multimeter. NOTE the reading.

e. Move the connection from the digital multimeter INPUT to the DC 503A CH A INPUT connector. Reconnect the DC 503A CH A TRIG LEVEL OUT to the multimeter.

f. Adjust the DC 503A CH A LEVEL control for a stable display on the DC 503A and oscilloscope.

g. Adjust the function generator FREQUENCY VARIABLE control and horizontal plug-in POSITION control to display a single period of $10\ \mu\text{s}$ on the crt.

h. Adjust the DC 503A CH A LEVEL control to center the falling edge of the displayed squarewave on the center vertical graticule line.

i. CHECK—that the digital multi meter readout indicates between +0.020 and -0.020.

j. Change the DC 503A COUPL to DC (out position).

k. Adjust the DC 503A CH A LEVEL control to center the falling edge off the displayed squarewave on the center vertical graticule line.

l. CHECK—that the digital multimeter reading is within .030 of value noted in step 20d.

m. Remove the DC 503A CH A TRIG LEVEL from the digital multimeter. Connect the function generator OUTPUT to the multimeter INPUT.

n. Adjust the function generator OFFSET control for a reading between -2.450 and -2.550 on the digital multimeter. NOTE the reading.

o. Disconnect the cable (with $50\ \Omega$ termination) from the digital multimeter INPUT and connect to the DC 503A CH A INPUT.

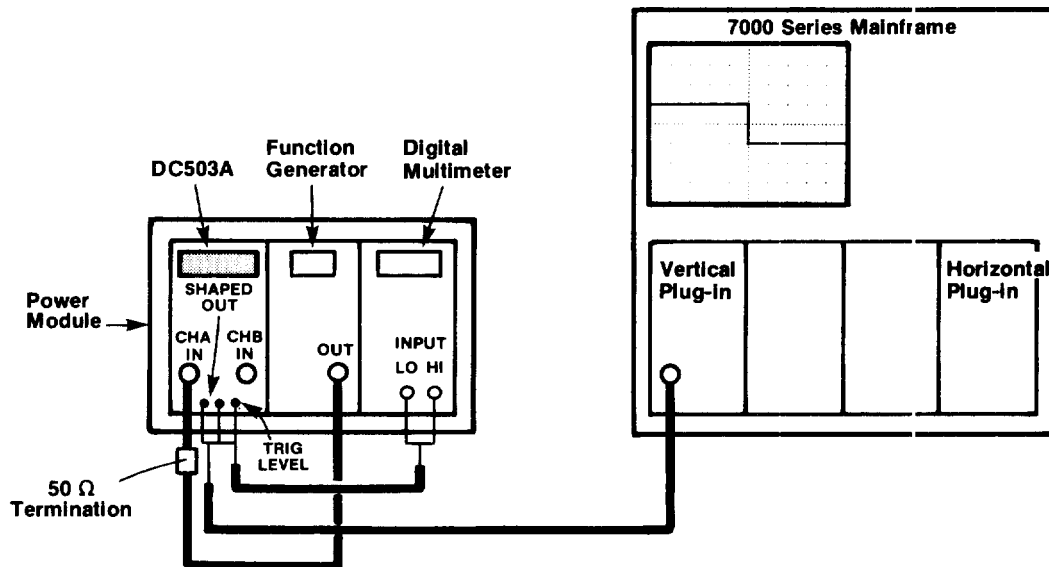

2971-07

Fig. 4-4. Check set-up for trigger level range ($\pm 3.5\ \text{V}$) and accuracy ($\pm 20\ \text{mV} \pm 5\%$ of reading).

p. Re-connect the tip jack-to-bnc cable from the DC 503A CH A TRIG LEVEL output (black terminal to COMMON) to the digital multimeter INPUT.

q. Adjust the DC 503A CH A LEVEL control to center the falling edge of the displayed squarewave on the center vertical graticule line.

r. CHECK-that the digital multi meter readout is within .030 of value noted in step 20n.

21. Check B Trigger Level Output Accuracy (± 20 mV, $\pm 0.5\%$ of reading). Refer to Fig. 4-5 check set-up and control settings in step 20.

a. Change the DC 503A FUNCTION switch to PERIOD B (AVGS).

b. Move the connection from the DC 503A A SHAPED OUT to the B SHAPED OUT (black terminal to COMMON).

c. Move the connection from the DC 503A A TRIG LEVEL to the B TRIG LEVEL output (black terminal to COMMON).

d. Move the coaxial cable with 50 Ω termination from the DC 503A CH A INPUT to the CH B INPUT.

e. Adjust the DC 503A CH B LEVEL control for a stable display on the DC 503A and oscilloscope.

f. Adjust the DC 503A CH B LEVEL control to center the falling edge of the displayed squarewave on the center vertical graticule line.

g. CHECK-that the digital multimeter readout indicates between +0.020 and -0.020.

h. Change the DC 503A COUPL to DC (out position).

i. Adjust DC 503A CH B LEVEL control to center the falling edge of the displayed squarewave on the center vertical graticule line.

j. CHECK-that the digital multimeter reading is within .030 of value noted in step 20n.

k. Disconnect the INPUT cable from the digital multimeter and connect the function generator OUTPUT to the digital multimeter INPUT.

l. Adjust the function generator OFFSET control for a reading between +2.450 V and + 2.550 V on the digital multimeter. NOTE the reading.

m. Disconnect the cable (with 50 Ω termination) from the digital multimeter INPUT and connect to the DC 503A CH B INPUT.

n. Re-connect the tip jack-to-bnc cable from the DC 503A CH B TRIG LEVEL output (black terminal to COMMON) to the digital multimeter INPUT.

o. Adjust the DC 503A CH B LEVEL control to center the falling edge of the displayed squarewave on the center vertical graticule line.

p. CHECK-that the digital multimeter readout is within .030 of value noted in step 21l.

REAR INTERFACE CHECKS

22. Check CH A and CH B Rear Interface Frequency Range (0 Hz to ≥ 50 MHz, DC; 10 Hz to ≥ 50 MHz, AC). optional.

NOTE

This procedure requires the removal of the power module top cover. Coaxial cable (50 Ω) interfacing is required between the power module and DC 503A. Good r. f. shielding is also required.



When instruments are operated with covers removed, DO NOT touch exposed connections or components. This procedure is to be completed by qualified technical personnel only.

A dc, ac signal source capable of ≥ 50 MHz frequency with an amplitude of ≥ 20 mVrms, 56 mV p-to-p is required for this check.

a. Turn off the power module. Remove the DC 503A from the power module.

TM 9-6625-474-14&P-3

b. Remove the top cover from the power module, exposing the interface connectors (refer to the Maintenance Section in the power module instruction manual).

c. Using an appropriate length 50 Ω coaxial cable (no connectors), attach one end of the cable center conductor to pin 16A of the DC 503 A rear interface connector. Attach the shielded conductor (same cable end) to pin 17A of the rear interface connector.

d. Attach the other cable end (center conductor and shield) to the appropriate output connections on the signal generator. Set generator for 56 mV p-to-p at 50 MHz.

e. Set the DC 503A FUNCTION switch to FREQUENCY A and the TIMING switch to 10 ms.

f. Connect the tip jack-to-bnc cable from the DC 503A A SHAPED OUT (black terminal to COMMON) to the vertical plug-in INPUT. Disconnect the A TRIG LEVEL output connection.

g. Adjust the DC 503A CH A LEVEL control for a stable display on the DC 503A and oscilloscope.

h. CHECK-that the DC 503A readout indicates approximately 50.0000 (MHz) with the display MHz/ μ SEC illuminated.

i. Detach the coaxial cable center conductor from pin 16A and attach to pin 17B of the DC 503A rear interface connector. Detach the shielded conductor from pin 17A and attach to pin 16B of the interface connector.

j. Change the DC 503A FUNCTION switch to PERIOD B (AVGS) and the AVGS switch to 10^6 .

k. Change the DC 503A A SHAPED OUT connection to the B SHAPED OUT.

l. Adjust the DC 503A CH B LEVEL control for a stable display on the DC 503A and oscilloscope.

m. CHECK-that the DC 503A readout indicates approximately 20.0000 (nSEC) with the display GHz/nSEC illuminated.

n. Remove all cables and connections.

This completes the Performance Check.

ADJUSTMENT PROCEDURE

Introduction

Use this Adjustment Procedure to restore the DC 503A to original performance requirements. This Adjustment Procedure need not be performed unless the instrument fails to meet the Performance Requirements of the Electrical characteristics listed in the Specification section, or if the Performance Check procedure cannot be completed satisfactorily. If the instrument has undergone repairs, the Adjustment Procedure is recommended.

Satisfactory completion of all adjustment steps in this procedure assures that the instrument will meet the Performance Requirements.

Test Equipment Required

The test equipment (or equivalent) listed in Table 4-1 is required for adjustment of the DC 503A. Specifications given for the test equipment are the minimum necessary for accurate adjustment. All test equipment is assumed to be correctly calibrated and operating within specifications.

If other test equipment is substituted, calibration set-up may need to be altered to meet the requirements of the equipment used.

Preparation

Access to the internal adjustments is achieved most easily when the DC 503A is connected to the power module with a flexible plug-in extender. Remove the left side cover of the DC 503A to reach the adjustments on the auxiliary board. Remove the right side cover to reach the adjustments on the main board. Refer to the Adjustment Locations in the pull-out pages at the rear of this manual.

Make adjustments at an ambient temperature between +20°C and +25° C.

Check Power Supplies

Preliminary control settings:

	Power Module
LINE SELECTOR	HI

VARIAC

Range switch	300 w
AC VOLT meter	120

Digital Multimeter

RANGE/FUNCTION	20 DC Volts
INPUT (pushbutton)	out

DC 503A

FUNCTION	FREQUENCY A
TIMING	1 s
DISPLAY	ccw
CH A LEVEL	midrange
CH B LEVEL	midrange
front panel push-buttons	out

1. Check the +12 V Supply Accuracy

- a. Insert the DC 503A and digital multi meter into the power module.
- b. Connect the power module power cord to the VARIAC and turn on the power module and VARIAC.
- c. Connect the test leads to digital multimeter HI and LO INPUTS.
- d. Connect the digital multimeter LO test lead to the DC 503A chassis ground. Connect the HI test lead to the cathode of diode CR1732, located on the DC 503A Main board.
- e. The digital multi meter readout must indicate between 12.600 and 11.400.

2. Check the -12 V Supply Accuracy

- a. Connect the digital multi meter HI test lead to the anode of diode CR1730, located on the DC 503A Main board.

TM 9-6625-474-14&P-3

b. The digital multimeter readout must indicate between 11280 and 12.720.

3. Check the 5V Supply Accuracy

a. Connect the digital multi meter HI test lead to the cathode of diode CR1733, located on the DC 503A Main board.

b. The digital multimeter readout must indicate between 4.700 and 5.300.

4. check the +2.7 V Supply Accuracy

a. connect the digital multi meter HI test lead to the emitter junction of transistors Q1032 and Q1020, located on the Auxiliary board.

b. The digital multimeter must indicate a readout between 2.500 and 2.900.

c. Remove all test leads.

5. Adjust the OFFSET ADJ, R1525 (channel A). Refer to Fig. 4-5 check set-up and control settings as shown in the Performance Check procedure, step 20.

a. Adjust the vertical plug-in POSITION control to center the trace over the center graticule line.

b. Adjust the DC 503A CH A LEVEL control for a stable display on the DC 503A and oscilloscope.

c. Adjust the function generator FREQUENCY VARIABLE control and the horizontal plug-in POSITION control for a 100 kHz display with a 10 μ s period.

d. Adjust the DC 503A CH A LEVEL control to center the displayed squarewave falling edge on the center crt graticule line.

e. ADJUST potentiometer R1525, located on the Auxiliary board, until the digital multimeter readout indicates between +0.010 and -0.010.

7. Adjust the Standard Timebase Accuracy, C1715 and Optional Timebase Accuracy, Y1710

a. Connect a coaxial cable from the WWVB Frequency Standard 1 MHz output signal to the DC 503A CH B INPUT.

b. Set the DC 503A FUNCTION switch to PERIOD B (AVGS) and the AVGS switch to 10^6 .

c. Adjust the DC 503A CH B LEVEL control for a stable display readout on the DC 503A.

d. Adjust the variable capacitor, C1715 (located on the Main board) until the DC 503A readout indicates between 999.9999 (nSEC) and 1000.0001 (nSEC) with the display GHz/nSEC illuminated.

NOTE

This sets the DC 503A oscillator within 1 part in 10^7 . It will take approximately 1 second for the display to up-date.

e. For the optional timebase adjust, change the DC 503A AVGS switch to 10^7 .

f. Adjust the DC 503,4 CH B LEVEL control for a stable display readout on the DC 503A.

NOTE

The Option 1 timebase adjustment is made through an access hole in the back of the oven time base, Y1710 located on the back side of the Main board.

g. Adjust the oven timebase, Y1710 until the DC 503A readout indicates between 999.9998 (nSEC-with display GHz/nSEC illuminated) and 000.00002 ns with display OVERFLOW illuminated.

NOTE

This sets the oscillator within 2 parts in 10^8 . It will take approximately 10 seconds for the display to up-date.

SECTION 5

MAINTENANCE

GENERAL MAINTENANCE INFORMATION

Static-Sensitive Components



Static discharge can damage any semiconductor component in this instrument.

This instrument contains electrical components that are susceptible to damage from static discharge. See Table 5-1 for relative susceptibility of various classes of semiconductors. Static voltages of 1 kV to 30 kV are common in unprotected environments.

Observe the following precautions to avoid damage:

1. Minimize handling of static-sensitive components.
2. Transport and store static-sensitive components or assemblies in their original containers, on a metal rail, or on conductive foam. Label any package that contains static-sensitive assemblies or components.
3. Discharge the static voltage from your body by wearing a wrist strap while handling these components. Servicing static-sensitive assemblies or components should be performed only at a static-free work station by qualified service personnel.
4. Nothing capable of generating or holding a static charge should be allowed on the work station surface.
5. Keep the component leads shorted together whenever possible.
6. Pick up components by the body, never by the leads.
7. Do not slide the components over any surface.
8. Avoid handling components in areas that have a floor or work surface covering capable of generating a static charge.

9. Use a soldering iron that is connected to earth ground.

10. Use only special antistatic suction type or wick type resoldering tools.

Table 5-1
Relative Susceptibility to Static Discharge Damage

Semiconductor Classes	Relative Susceptibility Levels ^a
MOS or CMOS microcircuits or discretes, or linear microcircuits with MOS inputs. (Most Sensitive)	1
ECL	2
Schottky signal diodes	3
Schottky TTL	4
High-frequency bipolar transistors	5
JFETs	6
Linear microcircuits	7
Low-power Schottky TTL	8
TTL (Least Sensitive)	9

^aVoltage equivalent for levels:

1 = 100 to 500 V	4 = 500 V	7 = 400 to 1000 V (est.)
2 = 200 to 500 V	5 = 400 to 600 V	8 = 900 V
3 = 250 V	6 = 600 to 800 V	9 = 1200 V

(Voltage discharged from a 100 pF capacitor through a resistance of 100 ohms.)

Cleaning

This instrument should be cleaned as often as operating conditions require. Loose dust accumulated on the outside of the instrument can be removed with a soft cloth or small brush. Remove dirt that remains with a soft cloth dampened in a mild detergent and water solution. Do not use abrasive cleaners.

CAUTION

To clean the front panel use freon, isopropyl alcohol, or totally denatured ethyl alcohol. Do not use petroleum based cleansing agents. Before using any other type of cleaner, consult your Tektronix Service Center or representative.

The best way to clean the interior is to blow off the accumulated dust with dry, low-velocity air (approximately 5 lb/in²) or use a soft brush or cloth dampened with a mild detergent and water solution.

Hold the board so the cleaning residue runs away from the connectors, Do not scrape or use an eraser to clean the edge connector contacts. Abrasive cleaning can remove the gold plating.

CAUTION

Circuit boards and components must be dry before applying power to prevent damage from electrical arcing.

Obtaining Replacement Parts

Electrical and mechanical parts can be obtained through your local Tektronix Field Office or representative. However, it may be possible to obtain many of the standard electronic components from a local commercial source. Before purchasing or ordering a part from a source other than Tektronix, Inc., check the Replaceable Electrical Parts list for the proper value, rating, tolerance, and description.

NOTE

When selecting replacement parts, remember that the physical size and shape of a component may affect its performance in the instrument.

Some parts are manufactured or selected by Tektronix, Inc., to satisfy particular requirements, or are manufactured for Tektronix, Inc., to our specifications. Most of the mechanical parts used in this instrument have been manufactured by Tektronix, Inc. To determine the manufacturer refer to the Replaceable Parts list and the Cross Reference index, Mfr. Code Number to Manufacturer.

When ordering replacement parts from Tektronix, Inc., include the following information.

1. Instrument type and option number.
2. Instrument serial number.
3. A description of the part (if electrical, include complete circuit number).
4. Tektronix part number.

Soldering Techniques

WARNING

To avoid electric-shock hazard, disconnect the instrument from the power source before soldering.

The reliability and accuracy of this instrument can be maintained only if proper soldering techniques are used when repairing or replacing parts. General soldering techniques which apply to maintenance of any precision electronic equipment should be used when working on this instrument. Use only 60/40 rosin-core, electronic grade solder. The choice of soldering iron is determined by the repair to be made.

CAUTION

Several of the circuit boards in the DC 503A are multilayer type boards with a conductive path laminated between the top and bottom board layers. All soldering on these boards should be done with extreme care to prevent breaking the connections to this conductive path. Only experienced maintenance personnel should attempt to repair the Main and Auxiliary boards. Do not allow solder or solder flux to flow under printed circuit board switches. The printed circuit board is part of the switch contacts, intermittent switch operation can occur if the contacts are contaminated.

When soldering on circuit boards or small wiring, use only a 15 W, pencil type soldering iron. A higher wattage soldering iron can cause the etched circuit wiring to separate from the board base material and melt the insulation from small wiring. Always keep the soldering iron tip properly tinned to ensure the best heat transfer to the solder joint. Apply only enough heat to remove the component or to make a good solder joint. To protect heat sensitive components, hold the component lead with a pair of long-nose pliers between the component body and the solder joint. Use a solder removing wick to remove excess solder from connections or to clean circuit board pads.

Semiconductors

When replacing transistors requiring silicone grease for heat transfer, replace the silicone grease as necessary.



Handle silicone grease with care. Avoid getting the silicone grease in your eyes. Wash hands thoroughly after use.

To remove socket mounted in-line integrated circuits use an extracting tool. This tool is available from Tektronix, Inc.; order Tektronix Part Number 003-0619-00. If an extracting tool is not available, use care to avoid damaging the pins. Pull slowly and evenly on both ends of the integrated circuit. Try to avoid disengaging one end before the other end.

Interconnecting Pins

Several methods of interconnection, including square pin and circuit board pin and ferrule are used to electricaly connect the circuit boards with other boards and components.

Several types of mating connectors are used for these interconnecting pins. If the mating connector is mounted on a Plug-on circuit board, special sockets are soldered into the board. If the mating connector is on the end of a lead, an end-lead pin connector is used. This connector mates with the interconnecting pin. The following information provides the removal and replacement procedure for the various interconnecting methods.

Square Pin Assemblies

See Fig. 5-1. These pins are of various lengths. They are attached to each other with a plastic strip. To remove them simply unsolder from the circuit board.

Circuit Board Pins and Ferrules

See Fig. 5-2. A circuit board pin replacement kit (including necessary tools, instructions, and replacement pins with attached ferrules) is available from Tektronix, Inc.; order Tektronix Part Number 040-0542-00. Replacing circuit board pins on multilayer boards is not recommended. (The multilayer boards in this instrument are listed under Soldering Techniques in this section.)

To replace a damaged pin, first disconnect any pin connectors. Then unsolder the damaged pin and pull it from the board with a pair of pliers, leaving the ferrule in the circuit board, if possible. If the ferrule remains in the

circuit board, remove the spare ferrule from the replacement pin and press the new pin into the hole in the circuit board. If the ferrule is removed with the damaged pin, clean out the hole using a solder removing wick and a scribe. Then press the replacement pin, with attached spare ferrule, into the circuit board.

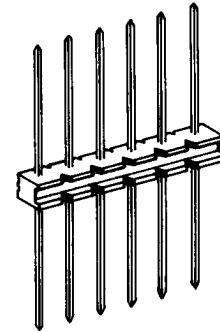

2971-08

Fig. 5-1. Typical square pin assembly.

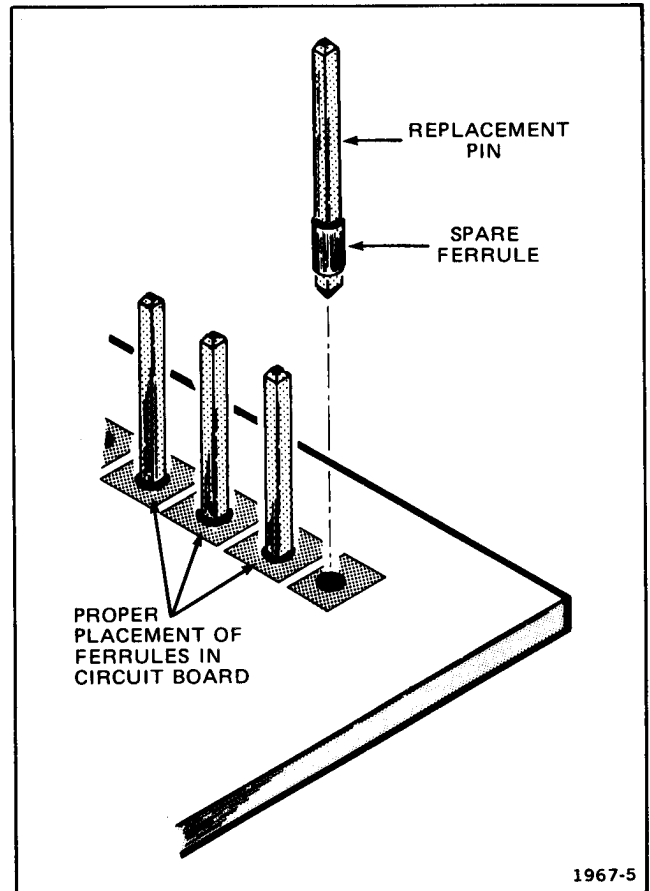
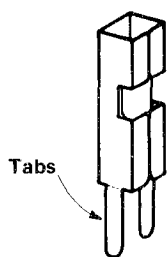

Fig. 5-2. Exploded view of circuit board pin and ferrule.

Position the replacement pin in the same manner as the original. Solder the pin to the circuit board on each side of the board. If the original pin was bent at an angle to mate with a connector, carefully bend the new pin to the same angle. Replace the pin connector.

Dual Entry Circuit Board Pin Sockets

The pin sockets on the circuit boards are soldered to the back of the board. See Fig. 5-3. To remove or replace one of these sockets, first unsolder the pin (use a vacuum-type resoldering tool to remove excess solder). Then straighten the tabs on the socket and remove the socket from the board.



2971-09

Fig. 5-3. Dual entry circuit board pin socket.

Place the new socket in the circuit board hole and press the tabs down against the board. Solder the tabs of the socket to the circuit board. Be careful not to get solder inside the socket.

NOTE

The spring tension of the pin sockets ensure a good connection between the circuit board and the pin. This spring tension can be destroyed by using the pin sockets as a connecting point for spring loaded probe tips, alligator clips, etc.

Bottom Entry Circuit Board Pin Sockets

To remove or replace these sockets unsolder the pins from the circuit board. Use a vacuum or other type unsoldering tool to remove excess solder. Use caution to prevent solder from entering the connector. See Fig. 5-4.

Multipin Connectors

The pin connectors used to connect the wires to the interconnecting pins are clamped to the ends of the wires. To replace damaged multipin connectors, remove the old pin connector from the holder. Do this by inserting a

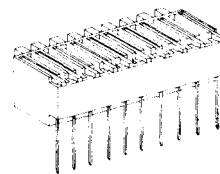

2971-10

Fig. 5-4. Bottom entry circuit board pin socket.

scribe between the connector and the holder and prying the connector from the holder. Clamp the replacement connector to the wire. Reinstall the connector in the holder.

If the individual end lead pin connectors are removed from the plastic holder, note the order of the individual wires for correct replacement in the holder. For proper replacement see Fig. 5-5.

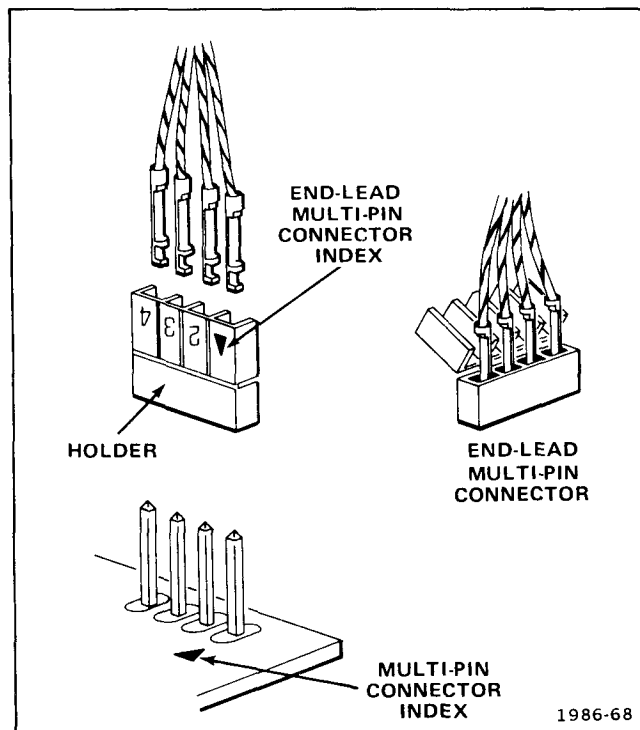
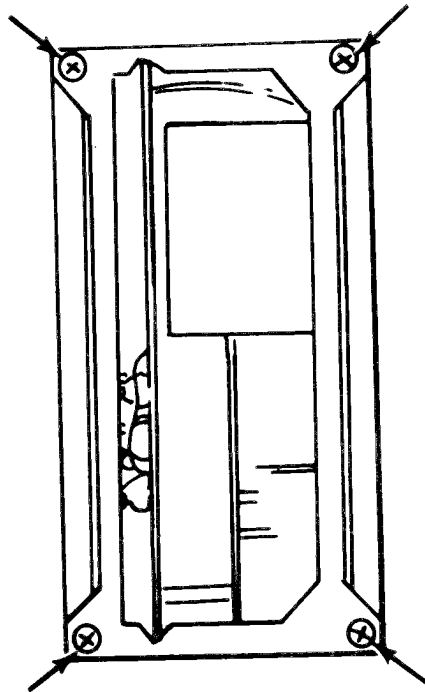

Fig. 5-5. Orientation and disassembly of multi pin connectors.

Circuit Board Removal

Remove the two screws and two fasteners attaching the rear of the plug-in frame. See Fig. 5-6. The bottom fasteners require a 3/16 inch wrench. Remove the front panel knob connected to the DISPLAY. Unsolder the wires to the front panel connectors. Disconnect all plugs to front panel connections. Remove the four screws as shown in Fig. 5-7. Remove both circuit boards by sliding backwards and out. To separate the two circuit boards, remove the four screws attaching the Auxiliary board to the Main board. When separating or replacing these boards, use care to avoid bending the interconnecting pins.



REMOVE THESE SCREWS AND FASTENERS TO REMOVE BACK OF FRAME. THE BOTTOM FASTENERS REQUIRE A 3/16" WRENCH.

Fig. 5-6. Rear frame removal.

Switch Maintenance

After separating the two boards, the front panel lever switches may be removed by removing the three screws attaching each lever switch to the circuit board. Use care when removing or assembling the lever switches to the circuit boards to prevent bending the contact fingers. When reassembling, carefully align the screw holes on the switch cover with the board. Place the switch cover on the board in the proper position before inserting the screws. To remove the front panel pushbutton switches, refer to Fig. 5-8.

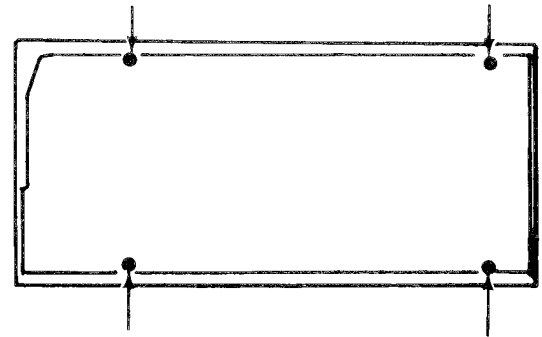

REMOVE THESE SCREWS TO REMOVE BOARDS FROM FRAME.

Fig. 5-7. Circuit board removal.

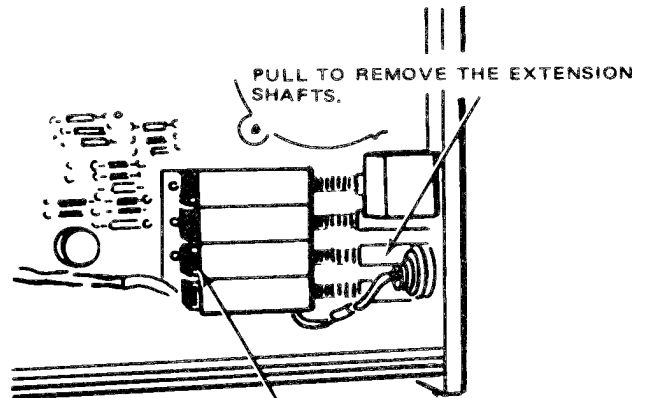

TO REMOVE SWITCHES BEND THE PLASTIC TAB BACK AND RAISE THE REAR OF THE SWITCH CLEAR OF THE TAB.

Fig. 5-8. Pushbutton switch removal.

To clean the board and switch contacts, use a lubricated contact cleaner such as, No Noise Contact Restorer.

Front Panel Latch Removal

To replace the latch, remove the screw under the pull tab. Pry up the pull tab bar from the latch assembly.

¹Electronic Chemical Corporation, 813 Communipaw Avenue, Jersey City, N.J. 07304

REAR INTERFACE INFORMATION

FUNCTIONS AVAILABLE AT REAR CONNECTOR

A slot exists between pins 21 and 22 on the rear connector. Insert a barrier in the corresponding position of the power module jack to prevent noncompatible plug-ins from being used in that compartment. Consult the power module manual for further information. Signal outputs for other specialized connections may be made to the rear interface connectors as shown in Fig. 5-9. Waveform timing is shown in Fig. 5-10. A description of these connections follows.

Decimal Point Scanned Output 27B

This contact goes high and remains high for one scan clock period. This indicates a decimal point to the right of the active digit. This output will drive two TTL loads.

Remote Start 26B

This connection duplicates the front panel START/STOP button. When this connection is slow and the DC 503A is in TOTALIZE A or TIME MANUAL modes, the counter counts. When this line goes high counting stops. The external device pulling this line low must sink 1.6 mA.

Scan Clock Out 24B

This connection provides a 2 to 2.5 kHz squarewave. A different front panel digit is displayed on each falling edge of the waveform. The display scans from time slot 1, the most significant digit, to time slot 8, the least significant digit, and then repeats. The corresponding bcd information transfers to the output at each falling edge of the scan clock. Data should be transferred to an external memory on the following positive going edge. This allows for propagation delays and ensures that bed, time slot and decimal point information have time to settle. This output will drive two TTL loads.

Overflow Out 23B

This line goes high when the counter overflows. It is capable of driving two TTL loads.

Channel A Level Out 22A

The voltage at this connection follows the channel A front panel trigger LEVEL control. The source impedance is 1 k Ω and the signal level is between ± 3.5 V.

Channel B Level Out 22B

The voltage at this connection follows the channel B front panel trigger LEVEL control. The source impedance is 1 k Ω and the signal level is between ± 3.5 V.

Bcd Outputs: Bcd (1), 19A; Bcd (2), 21B; Bcd (4), 20A; Bcd (8), 20B

These connections output the bcd information. The positive pulses are 1 scan clock period in length for each given digit. Each line can drive two TTL loads.

Data Good (Latch) Output 19B

This line is high when data is transferring from a count chain into the latches. Do not acquire data through the rear interface connector when this pin is high. This output will drive two TTL loads.

Channel A Input 16A

This is the channel A input connection when the front panel CH A SOURCE switch is in the INT position. This input is terminated in 50 Ω , with a maximum input of 4 V peak or 8 V peak-to-peak.

Channel A Input Ground 17A

This terminal is the ground return for the rear interface channel A input.

Channel B Input 17B

This is the channel B input connection when the front panel CH A SOURCE switch is in the INT position. This input is terminated in 50 Ω , with a maximum input of 4 V peak or 8 V peak-to-peak.

Channel B Input Ground 16B

This terminal is the ground return for the rear interface channel B input.

Reference 10 MHz Out 15B

This is the buffered output of the counter time base. This output is capable of driving two TTL loads.

Ground (Clock) 15A

This is the ground return for the clock input-output signals (21A, 15B, 14A).

Output or Input	Pin B		Pin A	Output or Input	
	28	Barrier Slot	28		
Decimal Point Scanned Output	27		27		
Remote Start	26		26	Reset In/Out	
	25		25	Time Slot One (TS1)	
Scan Clock Out	24		24		
Overflow Out	23		23		
Channel B Level Out	22		22	Channel A Level Out	
BCD (2) Output	21		TM 500 barrier slot	21	TTL Clock Input
BCD (8) Output	20			20	BCD (4) Output
Data Good (Latch) Output	19			19	BCD (1) Output
	18	18			
Channel B Input	17	17		Channel A Input Ground	
Channel B Input Ground	16	16		Channel A Input	
Reference 10 MHz Out	15	15		Gnd (clock)	
	14	14		External 10 MHz Clock Input	
	13	13			
+33.5 V dc	12	12		+33.5 V dc	
Collector lead of PNP series pass	11	11		Base lead of PNP series pass	
	10	10		Emitter lead of PNP series pass	
±33.5 V common	9	9		±33.5 V common	
-33.5 V dc	8	8		-33.5 V dc	
Collector lead of NPN series pass	7	Rear view of plug-in		7	Emitter lead of NPN series pass
	6			6	Base lead of NPN series pass
	5			5	
+11.5 V common	4		4	+11.5 V common	
+11.5 V common	3		3	+11.5 V common	
+11.5 V dc	2		2	+11.5 V dc	
	1		1		

2971-14

Fig. 5-9. Rear interface connector assignments.

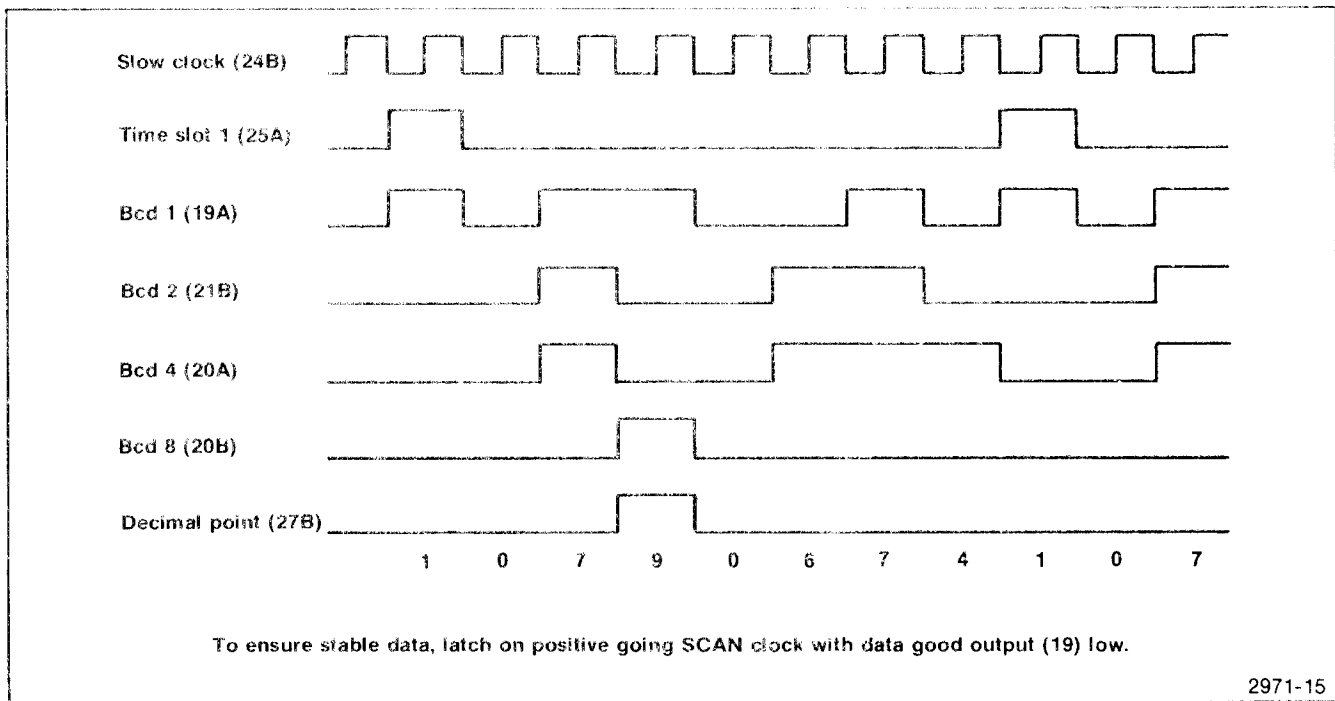

Fig. 5-10. Rear interface timing for a display of 1079.0674.

Reset In/Out 26A

This line goes low when the counters are reset. This line also goes low when the front panel RESET button is pressed. It can be pulsed low through the rear interface connector. The device pulling this line to ground must be capable of sinking 5 mA.

TTL Clock input 21A

This input is a single low power Schottky TTL load. The circuitry driving this input must source 20 μ A for a high input and sink 0.36 mA when driving low. An external time base, meeting the above requirements, can be connected to this terminal. The ground return for this input is pin 15A.

Time Slot 1 (TS1) 25A

This line is high during the time the most significant digit scanned. It goes high on the falling edge of the scan clock and returns low on the next falling edge of the scan clock. This output is capable of driving two TTL loads.

External 10 MHz Clock Input 14A

This input is ac coupled with an input impedance of approximately 1 k Ω . Any signal from about 500 mV rms to about 3 V rms is sufficient. Use pin 15A as ground return for this input.

SECTION 6

OPTIONS

Your instrument may be equipped with one or more instrument options or optional accessories. A brief description of each instrument option is given below. For further information on instrument options or optional accessories, see your Tektronix Catalog or contact your Tektronix Field Office. If additional options are made available for this instrument, they may be described in a Change Information insert at the back of this manual or in this section.

OPTION 01

Replaces the standard 10 MHz oscillator with a self contained, proportional temperature controlled oven oscillator for increased accuracy and stability. Information relative to Option 01 can be found on schematic , and in the Specification, Calibration, and Theory of Operation sections.

REPLACEABLE ELECTRICAL PARTS

PARTS ORDERING INFORMATION

Replacement parts are available from or through your local Tektronix, Inc. Field Office or representative.

Changes to Tektronix instruments are sometimes made to accommodate improved components as they become available, and to give you the benefit of the latest circuit improvements developed in our engineering department. It is therefore important, when ordering parts, to include the following information in your order: Part number, instrument type or number, serial number, and modification number if applicable.

If a part you have ordered has been replaced with a new or improved part, your local Tektronix, Inc. Field Office or representative will contact you concerning any change in part number.

Change information, if any, is located at the rear of this manual.

LIST OF ASSEMBLIES

A list of assemblies can be found at the beginning of the Electrical Parts List. The assemblies are listed in numerical order. When the complete component number of a part is known, this list will identify the assembly in which the part is located.

CROSS INDEX-MFR. CODE NUMBER TO MANUFACTURER

The Mfr. Code Number to Manufacturer Index for the Electrical Parts List is located immediately after this page. The Cross Index provides codes, names and addresses of manufacturers of components listed in the Electrical Parts List.

ABBREVIATIONS

Abbreviations conform to American National Standard Y1.1.

COMPONENT NUMBER (column one of the Electrical Parts List)

A numbering method has been used to identify assemblies, subassemblies and parts. Examples of this numbering method and typical expansions are illustrated by the following:

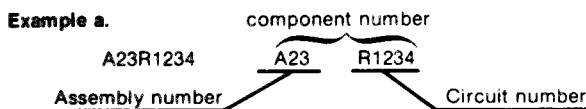

Read: Resistor 1234 of Assembly 23

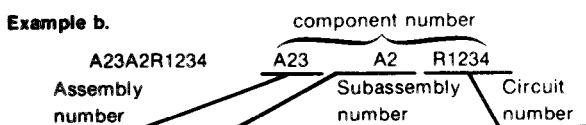

Read: Resistor 1234 of Subassembly 2 of Assembly 23

Only the circuit number will appear on the diagrams and circuit board illustrations. Each diagram and circuit board illustration is clearly marked with the assembly number. Assembly numbers are also marked on the mechanical exploded views located in the Mechanical Parts List. The component number is obtained by adding the assembly number prefix to the circuit number.

The Electrical Parts List is divided and arranged by assemblies in numerical sequence (e.g., assembly A1 with its subassemblies and parts, precedes assembly A2 with its subassemblies and parts).

Chassis-mounted parts have no assembly number prefix and are located at the end of the Electrical Parts List.

TEKTRONIX PART NO. (column two of the Electrical Parts List)

Indicates part number to be used when ordering replacement part from Tektronix.

SERIAL/MODEL NO. (columns three and four of the Electrical Parts List)

Column three (3) indicates the serial number at which the part was first used. Column four (4) indicates the serial number at which the part was removed. No serial number entered indicates part is good for all serial numbers.

NAME & DESCRIPTION (column five of the Electrical Parts List)

In the Parts List, an Item Name is separated from the description by a colon (:). Because of space limitations, an Item Name may sometimes appear as incomplete. For further Item Name identification, the U. S. Federal Cataloging Handbook H6-1 can be utilized where possible.

MFR. CODE (column six of the Electrical Parts List)

Indicates the code number of the actual manufacturer of the part. (Code to name and address cross reference can be found immediately after this page.)

MFR. PART NUMBER (column seven of the Electrical Parts List)

Indicates actual manufacturers part number.

CROSS INDEX-MFR. CODE NUMBER TO MANUFACTURER

Mfr. Code	Manufacturer	Address	City, State, Zip
01121	AL LEN-BRADLEY COMPANY	1201 2ND STREET SOUTH	MILWAUKEE, WI 53204
01295	TEXAS INSTRUMENTS, INC., SEMICONDUCTOR GROUP	P O BOX 5012, 13500 N CENTRAL EXPRESSWAY	DALLAS, TX 75222
02735	RCA CORPORATION, SOLID STATE DIVISION	ROUTE 202	SOMERVILLE, NY 08876
03508	GENERAL ELECTRIC COMPANY, SEMI-CONDUCTOR PRODUCTS DEPARTMENT	ELECTRONICS PARK	SYRACUSE, NY 13201
04222	AVX CERAMICS, DIVISION OF AVX CORP.	P O BOX 867, 19TH AVE. SOUTH	MYRTLE BEACH, SC 29577
04713	MOTOROLA, INC., SEMICONDUCTOR PROD. DIV.	5005 E MCDOWELL RD, PO BOX 20923	PHOENIX, AZ 85036
07263	FAIRCHILD SEMICONDUCTOR, A DIV. OF FAIRCHILD CAMERA AND INSTRUMENT CORP.	464 ELLIS STREET	MOUNTAIN VIEW, CA 94042
12697	CLAROSTAT MFG. CO., INC.	LOWER WASHINGTON STREET	DOVER, NH 03820
13511	AMPHENOL CARDRE DIV., BUNKER RAMO CORP.		LOS GATOS, CA 95030
14433	ITT SEMICONDUCTORS	3301 ELECTRONICS WAY P O BOX 3049	WEST PALM BEACH, FL 33402
22526	BERG ELECTRONICS, INC.	YOUK EXPRESSWAY	NEW CUMBERLAND, PA 17070
24546	CORNING GLASS WORKS, ELECTRONIC COMPONENTS DIVISION	550 HIGH STREET	BRADFORD, PA 16701
27014	NATIONAL SEMICONDUCTOR CORP.	2900 SEMICONDUCTOR DR.	SANTA CLARA, CA 95051
33096	COLORADO CRYSTAL CORPORATION	2303 W 8TH STREET	LOVELAND, CO 80537
34649	INTEL CORP.	3065 BOWERS AVE.	SANTA CLARA, CA 95051
55210	GETTIG ENG. AND MFG. COMPANY	PO BOX 85, OFF ROUTE 45	SPRING MILLS, PA 16875
55680	NICHICON/AMERICA/CORP.	6435 N PROESEL AVENUE	CHICAGO, IL 60645
56289	SPRAGUE ELECTRIC CO.	87 MARSHALL ST.	NORTH ADAMS, MA 01247
71279	CAMBRIDGE THERMIONIC CORP.	445 CONCORD AVE.	CAMBRIDGE, MA 02138
71400	BUSSMAN MFG., DIVISION OF MCGRAW-EDISON CO.	2536 W. UNIVERSITY ST.	ST. LOUIS, MO 63107
72982	ERIE TECHNOLOGICAL PRODUCTS, INC.	644 W. 12TH ST.	ERIE, PA 16512
73138	BECKMAN INSTRUMENTS, INC., HELIPOT DIV.	2500 HARBOR BLVD.	FULLERTON, CA 92634
74970	JOHNSON, E. F., CO.	299 10TH AVE. S. W.	WASECA, MN 56093
80009	TEKTRONIX, INC.	P O BOX 500	BEAVERTON, OR 97077
90201	MALLORY CAPACITOR CO., DIV. OF P. R. MALLORY AND CO., INC.	3029 E. WASHINGTON STREET P. O. BOX 372	INDIANAPOLIS, IN 46206
91637	DALE ELECTRONICS, INC.	P. O. BOX 609	COLUMBUS, NE 68601
95348	GORDOS CORPORATION	250 GLENWOOD AVENUE	BLOOMFIELD, NJ 07003

COMPONENT NO.	TEKTRONIX PART NO.	SERIAL/MODEL NO. EFF DSCONT	NAME & DESCRIPTION	MFR CODE
A10	670-6556-00		CKT BOARD ASSY:DISPLAY	80009
A12	670-6557-00		CKT BOARD ASSY:AUXILIARY	80009
A14	670-6558-00		CKT BOARD ASSY:MAIN	80009
A14	670-6559-00		CKT BOARD ASSY:MAIN (OPTION 1 ONLY)	80009
A10			CKT BOARD ASSY:DISPLAY	
A10CR1011	156-1036-00		MICROCIRCUIT,DI:PROGRAMMABLE INTERVAL TIME	34649
A10CR1012	150-1036-00		LAMP,LED:RED,3.OV,40MA	01295
A10CR1111	150-1036-00		LAMP,LED:RED,3.OV,40MA	01295
A10CR1211	150-1036-00		LAMP,LED:RED,3.OV,40MA	01295
A10CR1215	150-1036-00		LAMP,LED:RED,3.OV,40MA	01295
A10CR1311	150-1036-00		LAMP,LED:RED,3.OV,40MA	01295
A10DS1002	150-1011-02		LAMP,LED RDOUT:RED,7 SEG,1.0 DGIT	80009
A10DS1005	150-1011-02		LAMP,LED RDOUT:RED,7 SEG,1.0 DGIT	80009
A10DS1102	150-1011-02		LAMP,LED RDOUT:RED,7 SEG,1.0 DGIT	80009
A10DS1105	150-1011-02		LAMP,LED RDOUT:RED,7 SEG,1.0 DGIT	80009
A10DS1202	150-1011-02		LAMP,LED RDOUT:RED,7 SEG,1.0 DGIT	80009
A10DS1205	150-1011-02		LAMP,LED RDOUT:RED,7 SEG,1.0 DGIT	80009
A10DS1302	150-1011-02		LAMP,LED RDOUT:RED,7 SEG,1.0 DGIT	80009
A10DS1305	150-1011-02		LAMP,LED RDOUT:RED,7 SEG,1.0 DGIT	80009
A10J1012	131-1857-00		TERM, SET,PIN:36/0.025 SQ PIN,ON 0.1 CTRS	22526
A10J1101	131-1857-00		TERM, SET,PIN:36/0.025 SQ PIN,ON 0.1 CTRS	22526
A10J1102	131-1857-00		TERM. SET,PIN:36/0.025 SQ PIN,ON 0.1 CTRS	22526
A10R1009	315-0471-00		RES.,FXDE,CMPSN:470 OHM,5%,0.25W	01121
A10R1011	315-0471-00		RES.,FXD,CMPSN:470 OHM,5%,0.25W	01121
A10R1012	315-0471-00		RES.,FXD,CMPSN:470 OHM,5%,0.25W	01121
A12	-*-		CKT BOARD ASSY:AUXILIARY	
A12C1030	281-0773-00		CAP.,FXD,CER DI:0.01UF,10%,100V	04222
A12C1035	281-0773-00		CAP.,FXD,CER DI:0.01UF.,10%,100V	04222
A12C1120	281-0775-00		CAP.,FXD,CER DI:0.1UF,20%,50V	72982
A12C1130	281-0775-00		CAP.,FXD,CER DI:0.1UF,20%,50V	72982
A12C1200	281-0775-00		CAP.,FXD,CER DI:0.1UF,20%,50V	72982
A12C1202	281-0775-00		CAP.,FXD,CER DI:0.1UF,20%,50V	72982
A12C1220	281-0775-00		CAP.,FXD,CER DI:0.1UF,20%50V	72982
A12C1230	281-0775-00		CAP.,FXD,CER DI:0.1UF,20%,50V	72982
A12C1231	290-0782-00		CAP.,FXD,ELCTLT:4.7UF,+75-10%,35V	55680
A12C1232	290-0782-00		CAP.,FXD,ELCTLT:4.7UF,+75-10%,35V	55680
A12C1310	281-0775-00		CAP,FXD,CER DI:0.1UF,20%,50V	72982
A12C1311	281-0775-00		CAP.,FXD,CER DI:0.1UF,20%,50V	72982
A12C1330	281-0775-00		CAP.,FXD,CER DI:0.1UF,20%,50V	72982
A12C1400	281-0775-00		CAP.,FXD,CER DI:0.1UF,20%,50V	72982
A12C1420	281-0775-00		CAP.,FXD,CER DI:0.1UF,20%,50V	72982
A12C1430	281-0775-00		CAP.,FXD,CER DI:0.1UF,20%,50V	72982
A12C1510	281-0775-00		CAP.,FXD,CER DI:0.1UF,20%,50V	72982
A12C1519	281-0775-00		CAP.,FXD,CER DI:0.1UF,20%,50V	72982
A12C1520	281-0775-00		CAP.,FXD,CER DI:0.1UF,20%,50V	72982
A12C1522	281-0785-00		CAP.,FXD,CER DI:68PF,10%,100V	72982
A12C1523	281-0775-00		CAP.,FXD,CER DI:0.1UF,20%,50V	72982
A12C1530	281-0775-00		CAP.,FXD,CER DI:0.1UF,20%,50V	72982
A12C1532	281-0775-00		CAP.,FXD,CER DI:0.1UF,20%,50V	72982
A12C1533	290-0804-00		CAP.,FXD,ELCTLT:10UF,+50-10%,25V	55680

COMPONENT NO.	TEKTRONIX PART NO.	SERIAL/MODEL NO. EFF DSCONT	NAME & DESCRIPTION	MFR CODE	MFR PART NUMBER
A12C1600	281-0775-00		CAP.,FXD,CER DI:0.1UF,20%,50V	72982	8005D9AABZ5U104M
A12C1622	281-0775-00		CAP.,FXD,CER DI:0.1UF,20%,50V	72982	8005D9AABZ5U104M
A12C1629	281-0775-00		CAP.,FXD,CER DI:0.1UF,20%,50V	72982	8005D9AABZ5U104M
A12C1630	281-0775-00		CAP.,FXD,CER DI:0.1UF,20%,50V	72982	8005D9AABZ5U104M
A12C1631	281-0775-00		CAP.,FXD,CER DI:0.1UF,20%,50V	72982	8005D9AABZ5U104M
A12C1632	290-0804-00		CAP.,FXD,ELCTLT:10UF,+50-10%,25V	55680	25ULA10V-T
A12C1720	283-0359-00		CAP.,FXD,CER DI:1000PF,10%,200V	72982	8131N203C0G0102K
A12C1730	281-0622-00		CAP.,FXD,CER DI:47PF,1%,500V	72982	308-000C0G0470F
A12C1731	281-0716-00		CAP.,FXD,CER DI:13.8PF,1%,500V	72982	374-014C0G01389F
A12C1733	281-0775-00		CAP.,FXD,CER DI:0.1UF,20%,50V	72982	8005D9AABZ5U104M
A12C1830	283-0057-00		CAP.,FXD,CER DI:0.1UF,+80-20%,200V	56289	274C10
A12CR1021	152-0141-02		SEMICON D DEVICE:SILICON,30V,150MA	01295	1N4152R
A12CR1210	152-0066-00		SEMICON D DEVICE:SILICON,400V,750MA	14433	LG4016
A12CR1220	152-0141-02		SEMICON D DEVICE:SILICON,30V,150MA	01295	1N4152R
A12CR1222	152-0141-02		SEMICON D DEVICE:SILICON,30V,150MA	01295	1N4152R
A12CR1430	152-0141-02		SEMICON D DEVICE:SILICON,30V,150MA	01295	1N4152R
A12CR1620	152-0141-02		SEMICON D DEVICE:SILICON,30V,150MA	01295	1N4152R
A12CR1621	152-0141-02		SEMICON D DEVICE:SILICON,30V,150MA	01295	1N4152R
A12CR1630	152-0141-02		SEMICON D DEVICE:SILICON,30V,150MA	01295	1N4152R
A12CR1720	152-0246-00		SEMICON D DEVICE:SW,SI,40V,200MA	03508	DE140
A12CR1721	152-0246-00		SEMICON D DEVICE: SW, SI, 40V, 200MA	03508	DE140
A12J1020	131-1425-00		CONTACT SET,ELE:R ANGLE,0.150" L,STR OF 36	22526	65521-136
A12J1519	131-0608-00		TERMINAL,PIN:0.365 L X 0.025 PH BRZ GOLD	22526	47357
	-*-		(QTY 2)		
A12J1530	131-0608-00		TERMINAL,PIN:0.365 L X 0.025 PH BRZ GOLD	22526	47357
	-*-		(QTY 2)		
A12J1630	131-0608-00		TERMINAL,PIN:0.365 L X 0.025 PH BRZ GOLD	22526	47357
	-*-		(QTY 3)		
A12J1730	131-0608-00		TERMINAL,PIN:0.365 L X 0.025 PH BRZ GOLD	22526	47357
	-*-		(QTY 2)		
A12L1530	120-0382-00		XFMR,TOROID:14 TURNS,SINGLE	80009	120-0382-00
A12L1630	120-0382-00		XFMR,TOROID:14 TURNS,SINGLE	80009	120-0382-00
A12P1430	131-1934-00		TERM. SET,PIN:1 X 36,0.1 CTR,0.9 L	22526	65539-001
A12P1520	131-1934-00		TERM. SET,PIN:1 X 36,0.1 CTR,0.9 L	22526	65539-001
A12P1521	131-1934-00		TERM. SET,PIN:1 X 36,0.1 CTR,0.9 L	22526	65539-001
A12P1601	131-1934-00		TERM. SET,PIN:1 X 36,0.1 CTR,0.9 L	22526	65539-001
A12P1630	131-1934-00		TERM. SET,PIN:1 X 36,0.1 CTR,0.9 L	22526	65539-001
A12Q1020	151-0462-00		TRANSISTOR:SILICON,PNP	04713	TIP30C
A12Q1030	151-0342-00		TRANSISTOR:SILICON,PNP	07263	S035928
A12Q1032	151-0341-00		TRANSISTOR:SILICON,NPN	07263	S040065
A12Q1132	151-0220-00		TRANSISTOR:SILICON,PNP	07263	S036228
A12Q1133	151-0220-00		TRANSISTOR:SILICON,PNP	07263	S036228
A12Q1134	151-0220-00		TRANSISTOR:SILICON,PNP	07263	S036228
A12Q1300	151-0220-00		TRANSISTOR:SILICON,PNP	07263	S036228
A12Q1320	151-0220-00		TRANSISTOR:SILICON,PNP	07263	S036228
A12Q1321	151-0220-00		TRANSISTOR:SILICON,PNP	07263	S036228
A12Q1330	151-0220-00		TRANSISTOR:SILICON,PNP	07263	S036228
A12Q1331	151-0220-00		TRANSISTOR:SILICON,PNP	07263	S036228
A12Q1420	151-0220-00		TRANSISTOR:SILICON,PNP	07263	S036228
A12Q1530	151-0220-00		TRANSISTOR:SILICON,PNP	07263	S036228
A12Q1620	151-0427-00		TRANSISTOR:SILICON,NPN	80009	151-0427-00
A12Q1630	151-1117-00		TRANSISTOR:FE DUAL,N-CHANNEL,SI	80009	151-1117-00
A12R510	315-0470-00		RES.,FXD,CMPSN:47 OHM,5%,0.25W	01121	CB4705
A12R1021	307-0695-00		RES.,NTWK,FXD,FI:9,150 OHM,2%	01121	210A151
A12R1024	315-0511-00		RES.,FXD,CMPSN:510 OHM,5%,0.25W	01121	CB5115
A12R1031	315-0241-00		RES.,FXD,CMPSN:240 OHM,5%,0.25W	01121	CB2415
A12R1032	315-0751-00		RES.,FXD,CMPSN:750 OHM,5%,0.25W	01121	CB7515

COMPONENT NO.	TEKTRONIX PART NO.	SERIAL/MODEL NO. EFF DSCONT	NAME & DESCRIPTION	MFR CODE	MFR PART NUMBER
A12R1033	315-0361-00		RES.,FXD,CMPNSN:360 OHM,5%,0.25W	01121	CB3615
A12R1035	315-0681-00		RES.,FXD.CMPNSN:680 OHM,5%,0.25W	01121	CB6815
A12R1036	315-0362-00		RES.,FXD.CMPNSN:3.6K OHM,5%,0.25W	01121	CB3625
A12R1037	315-0132-00		RES.,FXD.CMPNSN:1.3K OHM,5%,0.25W	01121	CB1325
A12R1038	315-0680-00		RES.,FXD.CMPNSN:68 OHM,5%,0.25W	01121	CB6805
A12R1130	315-0151-00		RES.,FXD.CMPNSN:150 OHM,5%,0.25W	01121	CB1515
A12R1131	315-0103-00		RES.,FXD.CMPNSN:10K OHM,5%,0.25W	01121	CB1035
A12R1132	315-0103-00		RES.,FXD.CMPNSN:10K OHM,5%,0.25W	01121	CB1035
A12R1133	315-0103-00		RES.,FXD.CMPNSN:10K OHM,5%,0.25W	01121	CB1035
A12R1134	315-0103-00		RES.,FXD.CMPNSN:10K OHM,5%,0.25W	01121	CB1035
A12R1138	315-0301-00		RES.,FXD.CMPNSN:300 OHM,5%,0.25W	01121	CB3015
A12R1200	315-0121-00		RES.,FXD.CMPNSN:120 OHM,5%,0.25W	01121	CB1215
A12R1210	315-0751-00		RES.,FXD,CMPNSN:750 OHM,5%,0.25W	01121	CB7515
A12R1211	315-0162-00		RES.,FXD.CMPNSN:1.6K OHM,5%,0.25W	01121	CB1625
A12R1215	315-0302-00		RES.,FXD,CMPNSN:3K OHM,5%,0.25W	01121	CB3025
A12R1220	307-0695-00		RES.,NTWK,FXD.FI:9,150 OHM,2%	01121	210A151
A12R1230	315-0750-00		RES.,FXD,CMPNSN:75 OHM,5%,0.25W	01121	CB7505
A12R1231	315-0331-00		RES.,FXD,CMPNSN:330 OHM,5%,0.25W	01121	CB3315
A12R1300	315-0750-00		RES.,FXD.CMPNSN:75 OHM,5%,0.25W	01121	CB7505
A12R1301	315-0301-00		RES.,FXD.CMPNSN:300 OHM,5%,0.25W	01121	CB3015
A12R1302	315-0751-00		RES.,FXD.CMPNSN:750 OHM,5%,0.25W	01121	CB7515
A12R1303	315-0162-00		RES.,FXD.CMPNSN:1.6K OHM,5%,0.25W	01121	CB1625
A12R1304	315-0102-00		RES.,FXD.CMPNSN:1K OHM,5%,0.25W	01121	CB1025
A12R1310	307-0695-00		RES.,NTWK,FXD.FI:9,150 OHM,2%	01121	210A151
A12R1312	315-0101-00		RES.,FXD,CMPNSN:100 OHM,5%,0.25W	01121	CB1015
A12R1331	315-0472-00		RES.,FXD.CMPNSN:4.7K OHM,5%,0.25W	01121	CB4725
A12R1332	315-0472-00		RES.,FXD,CMPNSN:4.7K OHM,5%,0.25W	01121	CB4725
A12R1333	315-0472-00		RES.,FXD.CMPNSN:4.7K OHM,5%,0.25W	01121	CB4725
A12R1334	315-0472-00		RES.,FXD.CMPNSN:4.7K OHM,5%,0.25W	01121	CB4725
A12R1336	315-0151-00		RES.,FXD.CMPNSN:150 OHM,5%,0.25W	01121	CB1515
A12R1420	307-0695-00		RES.NTWK,FXD.FI:9,150 OHM,2%	01121	210A151
A12R1430	315-0510-00		RES.,FXD.CMPNSN:51 OHM,5%,0.25W	01121	CB5105
A12R1431	315-0820-00		RES.,FXD,CMPNSN:82 OHM,5%,0.25W	01121	CB8205
A12R1520	315-0820-00		RES.,FXD.CMPNSN:82 OHM,5%,0.25W	01121	CB8205
A12R1521	315-0510-00		RES.,FXD.CMPNSN:51 OHM,5%,0.25W	01121	CB5105
A12R1523	315-0561-00		RES.,FXD.CMPNSN:560 OHM,5%,0.25W	01121	CB5615
A12R1524	315-0101-00		RES.,FXD.CMPNSN:100 OHM,5%,0.25W	01121	CB1015
A12R1525	311-1559-00		RES.,VAR.NONWIR:10K OHM,20%,0.50W	73138	91-81-0
A12R1530	315-0121-00		RES.,FXD.CMPNSN:120 OHM,5%,0.25W	01121	CB1215
A12R1531	315-0561-00		RES.,FXD.CMPNSN:560 OHM,5%,0.25W	01121	CB5615
A12R1532	315-0561-00		RES.,FXD,CMPNSN:560 OHM,5%,0.25W	01121	CB5615
A12R1533	315-0561-00		RES.,FXD.CMPNSN:560 OHM,5%,0.25W	01121	CB5615
A12R1534	315-0122-00		RES.,FXD.CMPNSN:1.2K OHM,5%,0.25W	01121	CB1225
A12R1535	315-0122-00		RES.,FXD.CMPNSN:1.2K OHM,5%,0.25W	01121	CB1225
A12R1536	315-0561-00		RES.,FXD.CMPNSN:560 OHM,5%,0.25W	01121	CB5615
A12R1537	315-0561-00		RES.,FXD.CMPNSN:560 OHM,5%,0.25W	01121	CB5615
A12R1538	315-0221-00		RES.,FXD.CMPNSN:220 OHM,5%,0.25W	01121	CB2215
A12R1539	315-0221-00		RES.,FXD.CMPNSN:220 OHM,5%,0.25W	01121	CB2215
A12R1610	307-1096-00		RES NTWK,FXD FI:7.2K OHM,2%,1W	91637	MSP08A01202G
A12R1620	315-0102-00		RES.,FXD.CMPNSN:1K OHM,5%,0.25W	01121	CB1025
A12R1621	315-0302-00		RES.,FXD.CMPNSN:3K OHM,5%,0.25W	01121	CB3025
A12R1622	321-0414-00		RES.,FXD.FILM:200K OHM,1%,0.125W	91637	MFF1816G20002F
A12R1623	315-0474-00	XB020320	RES.,FXD.CMPNSN:470K OHM,5%,0.25W	01121	CB4745
A12R1624	321-0201-00	B01010(B020319	RES.,FXD,FILM:1.21K OHM,1%,0.125W	91637	MFF1816G12100F
A12R1624	321-0222-00	B020320	RES.,FXD.FILM:2K OHM,1%,0.125W	91637	MFF1816G20000F
A12R1625	315-0472-00		RES.,FXD.CMPNSN:4.7K OHM,5%,0.25W	01121	CB4725
A12R1626	315-0472-00		RES.,FXD.CMPNSN:4.7K OHM,5%,0.25W	01121	CB4725

COMPONENT NO.	TEKTRONIX PART NO.	SERIAL/MODEL NO. EFF DSCONT	NAME & DESCRIPTION	MFR CODE	MFR PART NUMBER
A12R1627	315-0680-00		RES.,FXD,CMPSPN:68 OHM,5%,0.25W	01121	CB6805
A12R1628	321-0481-00		RES.,FXD.FILM:1M OHM,1%,0.125W	24546	NA4D1004F
A12R1629	315-0154-00		RES.,FXD.CMPSPN:150K OHM,5%,0.25W	01121	CB1545
A12R1630	315-0131-00		RES.,FXD.CMPSPN:130 OHM,5%,0.25W	01121	CB1315
A12R1631	315-0131-00		RES.,FXD.CMPSPN:130 OHM,5%,0.25W	01121	CB1315
A12R1632	321-0618-00		RES.,FXD.FILM:250K OHM,1%,0.125W	91637	MFF1816G25002F
A12R1633	321-0891-00		RES.,FXD.FILM:800K OHM,1%,0.125W	91637	MFF1816G80002F
A12R1634	315-0122-00		RES.,FXD.CMPSPN:1.2K OHM,5%,0.25W	01121	CB1225
A12R1635	315-0122-00		RES.,FXD.CMPSPN:1.2K OHM,5%,0.25W	01121	CB1225
A12R1636	315-0202-00		RES.,FXD.CMPSPN:2K OHM,5%,0.25W	01121	CB2025
A12R1637	315-0432-00		RES.,FXD.CMPSPN:4.3K OHM,5%,0.25W	01121	CB4325
A12R1710	307-0445-00		RES.NTWK,FXD.FI:4.7K OHM,20%,(9) RES	91637	MSP10A01-472M
A12R1720	315-0391-00		RES.,FXD.CMPSPN:390 OHM,5%,0.25W	01121	CB3915
A12R1730	315-0102-00		RES.,FXD.CMPSPN:1K OHM,5%,0.25W	01121	CB1025
A12R1731	315-0510-00		RES.,FXD.CMPSPN:51 OHM,5%,0.25W	01121	CB5105
A12R1734	315-0151-00		RES.,FXD.CMPSPN:150 OHM,5%,0.25W	01121	CB1515
A12S1720	263-0010-00		SWITCH PB ASSY:1 PUSH,7.5MM,W/2 CONTACTS	80009	263-0010-00
A12S1730	263-0010-00		SWITCH PB ASSY:1 PUSH,7.5MM,W/2 CONTACTS	80009	263-0010-00
A12S1731	263-0010-00		SWITCH PB ASSY:1 PUSH,7.5MM,W/2 CONTACTS	80009	263-0010-00
A12S1732	263-0010-00		SWITCH PB ASSY:1 PUSH,7.5MM,W/2 CONTACTS	80009	263-0010-00
A12S1810	263-0074-00		SW LEVER ASSY:	80009	263-0074-00
A12U1120	156-0230-00		MICROCIRCUIT,DI:DUAL D MA-SLAVE FLIP-FLOP	80009	156-0230-00
A12U1121	156-0230-00		MICROCIRCUIT,DI:DUAL D MA-SLAVE FLIP-FLOP	80009	156-0230-00
A12U1122	156-0411-00		MICROCIRCUIT,LI:QUAD-COMP,SGL SUPPLY	27014	LM339N
A12U1220	156-0205-00		MICROCIRCUIT,DI:QUAD 2-INPUT NOR GATE	80009	156-0205-00
A12U1221	156-0688-00		MICROCIRCUIT,DI:DUAL J-K MASTER SLAVE FF	04713	MC10135L
A12U1300	156-0182-00		MICROCIRCUIT,DI:TRIPLE 2-3-2 INPUT GATE	80009	156-0182-00
A12U1310	156-0230-00		MICROCIRCUIT,DI:DUAL D MA-SLAVE FLIP-FLOP	80009	156-0230-00
A12U1320	156-0205-00		MICROCIRCUIT,DI:QUAD 2-INPUT NOR GATE	80009	156-0205-00
A12U1321	156-0230-00		MICROCIRCUIT,DI:DUAL D MA-SLAVE SLIP-FLOP	80009	156-0230-00
A12U1330	156-0205-00		MICROCIRCUIT,DI:QUAD 2-INPUT NOR GATE	80009	156-0205-00
A12U1400	156-0656-00		MICROCIRCUIT,DI:DECADE COUNTER	01295	SN74LS90N OR J
A12U1401	156-1448-00		MICROCIRCUIT,DI:DUAL 4-BIT DECADE COUNTER	80009	156-1448-00
A12U1410	156-0230-00		MICROCIRCUIT,DI:DUAL D MA-SLAVE FLIP-FLOP	80009	156-0230-00
A12U1411	156-0230-00		MICROCIRCUIT,DI:DUAL D MA-SLAVE FLIP-FLOP	80009	156-0230-00
A12U1420	156-0205-00		MICROCIRCUIT,DI:QUAD 2-INPUT NOR GATE	80009	156-0205-00
A12U1421	156-0295-00		MICROCIRCUIT,DI:TRIPLE EXCL OR EXCL NOR	80009	156-0295-00
A12U1430	156-0205-00		MICROCIRCUIT,DI:QUAD 2-INPUT NOR GATE	80009	156-0205-00
A12U1500	156-0866-00		MICROCIRCUIT,DI:13 INP NAND GATES	04713	SN74LS133
A12U1501	156-1448-00		MICROCIRCUIT,DI:DUAL 4-BIT DECADE COUNTER	80009	156-1448-00
A12U1510	156-0382-00		MICROCIRCUIT,DI:QUAD 2-INPUT NAND GATE	01295	SN74LS00(N OR J)
A12U1511	156-0382-00		MICROCIRCUIT,DI:QUAD 2-INPUT NAND GATE	01295	SN74LS00(N OR J)
A12U1530	156-0369-00		MICROCIRCUIT,DI:TRIPLE LINE RECEIVER	80009	156-0369-00
A12U1600	156-0745-00		MICROCIRCUIT,DI:HEX INVERTER	80009	156-0745-00
A12U1601	156-0524-00		MICROCIRCUIT,DI:TRIPLE 3-INPUT NAND GATES	80009	156-0524-00
A12U1610	156-1448-00		MICROCIRCUIT,DI:DUAL 4-BIT DECADE COUNTER	80009	156-1448-00
A12U1611	156-1478-00		MICROCIRCUIT,DI:QUAD 2-INP AND GATE	02735	CD4081BF
A12U1620	156-1149-00		MICROCIRCUIT,LI:OPERATIONAL AMP.JFET INPUT	27014	LF351N
A12W1320	131-0566-00		BUS CONDUCTOR:DUMMY RES,2.375,22 AWG	55210	L-2007-1

COMPONENT NO.	TEKTRONIX PART NO.	SERIAL/MODEL NO. EFF DSCONT	NAME & DESCRIPTION	MFR CODE	MFR PART NUMBER
A14	-*-		CKT BOARD ASSY:MAIN		
A14C1030	283-0057-00		CAP.,FXD,CER DI:0.1UF,+80-20%,200V	56289	274C10
A14C1120	283-0359-00		CAP.,FXD,CER DI:1000PF,10%,200V	72982	8131N203C0G0102K
A14C1130	281-0622-00		CAP.,FXD,CER DI:47PF,1%,500V	72982	308-000C0G0470F
A14C1131	281-0716-00		CAP.,FXD,CER DI:13.8PF,1%,500V	72982	374-014C0G01389F
A14C1133	281-0775-00		CAP.,FXD,CER DI:0.1UF,20%,50V	72982	8005D9AABZ5U104M
A14C1220	281-0775-00		CAP.,FXD,CER DI:0.1UF,20%,50V	72982	8005D9AABZ5U104M
A14C1221	281-0775-00		CAP.,FXD,CER DI:0.1UF,20%,50V	72982	8005D9AABZ5U104M
A14C1230	281-0775-00		CAP.,FXD,CER DI:0.1UF,20%,50V	72982	8005D9AABZ5U104M
A14C1231	281-0775-00		CAP.,FXD,CER DI:0.1UF,20%,50V	72982	8005D9AABZ5U104M
A14C1232	290-0804-00		CAP.,FXD,ELCTLT:10UF,+50-10%,25V	55680	25ULA10V-T
A14C1233	281-0775-00		CAP.,FXD,CER DI:0.1UF,20%,50V	72982	8005D9AABZ5U104M
A14C1320	281-0775-00		CAP.,FXD,CER DI:0.1UF,20%,50V	72982	8005D9AABZ5U104M
A14C1322	281-0785-00		CAP.,FXD,CER DI:68PF,10%,100V	72982	8035D2AADCOG680K
A14C1323	281-0775-00		CAP.,FXD,CER DI:0.1UF,20%,50V	72982	8005D9AABZ5U104M
A14C1330	281-0775-00		CAP.,FXD,CER DI:0.1UF,20%,50V	72982	8005D9AABZ5U104M
A14C1331	281-0775-00		CAP.,FXD,CER DI:0.1UF,20%,50V	72982	8005D9AABZ5U104M
A14C1332	290-0804-00		CAP.,FXD,ELCTLT:10UF,+50-10%,25V	55680	25ULA10V-T
A14C1400	290-0782-00		CAP.,FXD,ELCTLT:4.7UF,+75-10%,35V	55680	35ULA4R7V-T
A14C1410	281-0775-00		CAP.,FXD,CER DI:0.1UF,20%,50V	72982	8005D9AABZ5U104M
A14C1411	281-0772-00		CAP.,FXD,CER DI:0.0047UF,10%,100V	04222	GC701C472K
A14C1420	281-0775-00		CAP.,FXD,CER DI:0.1UF,20%,50V	72982	8005D9AABZ5U104M
A14C1421	281-0775-00		CAP.,FXD,CER DI:0.1UF,20%,50V	72982	8005D9AABZ5U104M
A14C1430	290-0804-00		CAP.,FXD,ELCTLT:10UF,+50-10%,25V	55680	25ULA10V-T
A14C1431	281-0772-00		CAP.,FXD,CER DI:0.0047UF,10%,100V	04222	GC701C472K
A14C1510	281-0772-00		CAP.,FXD,CER DI:0.0047UF,10%,100V	04222	GC701C47K
A14C1511	281-0812-00		CAP.,FXD,CER DI:1000PF,10%,100V	72982	8035D9AADX7R102K
A14C1600	290-0745-00		CAP.,FXD,ELCTLT:22UF,+50-10%,25V	56289	502D225
A14C1601	281-0775-00		CAP.,FXD,CER DI:0.1UF,20%,50V	72982	8005D9AABZ5U104M
A14C1610	281-0775-00		CAP.,FXD,CER DI:0.1UF,20%,50V	72982	8005D9AABZ5U104M
A14C1700	281-0775-00		CAP.,FXD,CER DI:0.1UF,20%,50V	72982	8005D9AABZ5U104M
	-*-		(OPTION 1 ONLY)		
A14C1701	290-0183-00		CAP.,FXD,ELCTLT:1UF,10%,35V	90201	TAE105K035P1A
A14C1702	281-0775-00		CAP.,FXD,CER DI:0.1UF,20%,50V	72982	8005D9AABZ5U104M
	-*-		(OPTION 1 ONLY)		
A14C1710	281-0630-00		CAP.,FXD,CER DI:390PF,5%,500V	72982	630000Y5D391J
	-*-		(STANDARD ONLY)		
A14C1711	281-0630-00		CAP.,FXD,CER DI:390PF,5%,500V	72982	630000Y5D391J
	-*-		(STANDARD ONLY)		
A14C1712	281-0564-00		CAP.,FXD,CER DI:24PF,5%,500V	72982	301-000C0G0240J
	-*-		(STANDARD ONLY)		
A14C1713	281-0775-00		CAP.,FXD,CER DI:0.1UF,20%,50V	72982	8005D9AABZ5U104M
	-*-		(STANDARD ONLY)		
A14C1714	281-0775-00		CAP.,FXD,CER DI:0.1UF,20%,50V	72982	8005D9AABZ5U104M
A14C1715	281-0153-00		CAP.,VAR,AIR DI:1.7-10PF,250V	74970	187-0106-005
	-*-		(STANDARD ONLY)		
A14C1730	290-0804-00		CAP.,FXD,ELCTLT:10UF,+50-10%,25V	55680	25ULA10V-T
A14C1731	281-0775-00		CAP.,FXD,CER DI:0.1UF,20%,50V	72982	8005D9AABZ5U104M
A14C1732	281-0775-00		CAP.,FXD,CER DI:0.1UF,20%,50V	72982	8005D9AABZ5U104M
A14C1733	290-0746-00		CAP.,FXD,ELCTLT:47UF,+50-10%,16V	55680	16U-47V-T
A14C1820	281-0773-00		CAP.,FXD,CER DI:0.01UF,10%,100V	04222	GC70-1C103K
A14C1830	281-0812-00		CAP.,FXD,CER DI:1000PF,10%,100V	72982	8035D9AADX7R102K
A14CR1110	152-0066-00		SEMICONV DEVICE:SILICON,400V,750MA	14433	LG4016
A14CR1120	152-0246-00		SEMICONV DEVICE:SW,SI,40V,200MA	03508	DE140
A14CR1121	152-0246-00		SEMICONV DEVICE:SW,SI,40V,200MA	03508	DE140
A14CR1220	152-0141-02		SEMICONV DEVICE:SILICON,30V,150MA	01295	1N4152R
A14CR1221	152-0141-02		SEMICONV DEVICE:SILICON,30V,150MA	01295	1N4152R

COMPONENT NO.	TEKTRONIX PART NO.	SERIAL/MODEL NO. EFF DSCONT	NAME & DESCRIPTION	MFR CODE	MFR PART NUMBER
A14CR1230	152-0141-02		SEMICONV DEVICE:SILICON,30V,150MA	01295	1N4152R
A14CR1700	152-0141-02		SEMICONV DEVICE:SILICON,30V,150M	01295	1N4152R
A14CR1721	152-0141-02		SEMICONV DEVICE:SILICON,30V,150MA	01295	1N4152R
A14CR1730	152-0066-00		SEMICONV DEVICE:SILICON,400V,750MA	14433	LG4016
A14CR1731	152-0141-02		SEMICONV DEVICE:SILICON,30V,150MA	01295	1N4152R
A14CR1732	152-0066-00		SEMICONV DEVICE:SILICON,400V,750MA	14433	LG4016
A14CR1733	152-0066-00		SEMICONV DEVICE:SILICON,400V,750MA	14433	LG4016
A14CR1810	152-0141-02		SEMICONV DEVICE:SILICON,30V,150MA	01295	1N4152R
A14CR1811	152-0141-02		SEMICONV DEVICE:SILICON,30V,150MA	01295	1N4152R
A14F1820	159-0025-00		FUSE,CARTRIDGE:3AG,0.5A,250V,FAST-BLOW	71400	AGC 1/2
A14F1821	159-0025-00		FUSE,CARTRIDGE:3AG,0.5A,250V,FAST-BLOW	71400	AGC 1/2
A14F1830	159-0015-00		FUSE,CARTRIDGE:3AG.3A,250V,FAST-BLOW	71400	AGC 3
A14J1130	131-0608-00		TERMINAL,PIN:0.365 L X 0.025 PH BRZ GOLD	22526	47357
	--*		(QTY 2)		
A14J1230	131-0608-00		TERMINAL,PIN:0.365 L X 0.025 PH BRZ GOLD	22526	47357
	--*		(QTY 3)		
A14J1300	131-0608-00		TERMINAL,PIN:0.365 L X 0.025 PH BRZ GOLD	22526	47357
	--*		(QTY 7)		
A14J1320	131-0608-00		TERMINAL,PIN:0.365 L X 0.025 PH BRZ GOLD	22526	47357
	--*		(QTY 2)		
A14J1400	131-0608-00		TERMINAL,PIN:0.365 L X 0.025 PH BRZ GOLD	22526	47357
	--*		(QTY 8)		
A14J1500	131-0608-00		TERMINAL,PIN:0.365 L X 0.025 PH BRZ GOLD	22526	47357
	--*		(QTY 8)		
A14J1520	136-0263-04		SOCKET,PIN TERM:FOR 0.025 INCH SQUARE PIN	22526	75377-001
A14J1521	136-0263-04		SOCKET,PIN TERM:FOR 0.025 INCH SQUARE PIN	22526	75377-001
A14J1710	131-0608-00		TERMINAL,PIN:0.365 L X 0.025 PH BRZ GOLD	22526	47357
	--*		(QTY 3)		
A14J1720	131-0608-00		TERMINAL,PIN:0.365 L X 0.025 PH BRZ GOLD	22526	47357
	--*		(QTY 3)		
A14J1810	131-0608-00		TERMINAL,PIN:0.365 L X 0.025 PH BRZ GOLD	22526	47357
	--*		(QTY 2)		
A14J1820	131-0608-00		TERMINAL,PIN:0.365 L X 0.025 PH BRZ GOLD	22526	47357
	--*		(QTY 2)		
A14K1800	148-0076-00		RELAY,REED:1 FORM A,5V,0.25A,100V	95348	F81-1447
A14K1810	148-0076-00		RELAY,REED:1 FORM A,5V,0.25A,100V	95348	F81-1447
A14L1230	120-0382-00		XFMR,TOROID:14 TURNS,SINGLE	80009	120-0382-00
A14L1330	120-0382-00		XFMR,TOROID:14 TURNS,SINGLE	80009	120-0382-00
A14L1600	108-0422-00		COIL,RF:FIXED,82UH	80009	108-0422-00
A14Q1220	151-0427-00		TRANSISTOR:SILICON,NPN	80009	151-0427-00
A14Q1230	151-1117-00		TRANSISTOR:FE DUAL,N-CHANNEL,SI,DMOS	80009	151-1117-00
A14Q1300	151-0504-00		TRANSISTOR:SILICON,N-CHAN,UNIUNCTION	04713	2N4851
A14Q1301	151-0302-00		TRANSISTOR:SILICON,NPN	07263	S038487
A14Q1400	151-0302-00		TRANSISTOR:SILICON,NPN	07263	S038487
A14Q1500	151-0301-00		TRANSISTOR:SILICON,PNP	27014	2N2907A
A14Q1700	151-0341-00		TRANSISTOR:SILICON,NPN	07263	S040065
A14Q1701	151-0190-00		TRANSISTOR:SILICON,NPN	07263	S032677
	--*		(STANDARD ONLY)		
A14Q1720	151-0188-00		TRANSISTOR:SILICON,PNP	04713	SPS6868K
A14Q1721	151-0302-00		TRANSISTOR:SILICON,NPN	07263	S038487
A14Q1722	151-0432-00		TRANSISTOR:SILICON,NPN	80009	151-0432-00
A14Q1723	151-0453-00		TRANSISTOR:SILICON,PNP	80009	151-0453-00
A14Q1724	151-0453-00		TRANSISTOR:SILICON,PNP	80009	151-0453-00
A14Q1725	151-0190-00		TRANSISTOR:SILICON,NPN	07263	S032677
A14Q1800	151-0190-00		TRANSISTOR:SILICON,NPN	07263	S032677
A14R610	315-0470-00		RES.,FXD,CMPSPN:47 OHM,5%,0.25W	01121	CB4705
A14R1100	315-0102-00		RES.,FXD.CMPSPN:1K OHM,5%,0.25W	01121	CB1025

COMPONENT NO.	TEKTRONIX PART NO.	SERIAL/MODEL NO. EFF DSCONT	NAME & DESCRIPTION	MFR CODE	MFR PART NUMBER
A14R1110	315-0512-00		RES.,FXD,CMPSPN:5.1K OHM,5%,0.25W	01121	CB5125
A14R1120	315-0391-00		RES.,FXD.CMPSPN:390 OHM,5%,0.25W	01121	CB3915
A14R1130	315-0102-00		RES.,FXD,CMPSPN:1K OHM,5%,0.25W	01121	CB1025
A14R1132	315-0510-00		RES.,FXD.CMPSPN:51 OHM,5%,0.25W	01121	CB5105
A14R1134	315-0151-00		RES.,FXD.CMPSPN:150 OHM,5%,0.25W	01121	CB1515
A14R1210	315-0512-00		RES.,FXD.CMPSPN:5.1K OHM,5%,0.25W	01121	CB5125
A14R1212	315-0512-00		RES.,FXD.CMPSPN:5.1K OHM,5%,0.25W	01121	CB5125
A14R1213	307-0502-00		RES.NTWK.THK FI:1.8 OHM,20%,(9) RES	91637	MSP10A01-182M
A14R1220	315-0472-00		RES.,FXD.CMPSPN:4.7K OHM,5%,0.25W	01121	CB4725
A14R1221	315-0302-00		RES.,FXD.CMPSPN:3K OHM,5%,0.25W	01121	CB3025
A14R1222	321-0481-00		RES.,FXD.FILM:1M OHM,1%,0.125W	24546	NA4D1004F
A14R1223	315-0474-00	XB020320	RES.,FXD.CMPSPN:470K OHM,5%,0.25W (STANDARD ONLY)	01121	CB4745
A14R1223	315-0474-00	XB020450	RES.,FXD.CMPSPN:470K OHM,5%,0.25W (OPTION 1 ONLY)	01121	CB4745
A14R1224	315-0680-00		RES.,FXD.CMPSPN:68 OHM,5%,0.25W	01121	CB6805
A14R1225	321-0618-00		RES.,FXD.FILM:250K OHM,1%,0.125W	91637	MFF1816G25002F
A14R1226	315-0154-00		RES.,FXD.CMPSPN:150K OHM,5%,0.25W	01121	CB1545
A14R1229	315-0472-00		RES.,FXD.CMPSPN:4.7K OHM,5%,0.25W	01121	CB4725
A14R1230	321-0891-00		RES.,FXD.FILM:800K OHM,1%,0.125W	91637	MFF1816G80002F
A14R1231	315-0131-00		RES.,FXD.CMPSPN:130 OHM,5%,0.25W	01121	CB1315
A14R1232	315-0202-00		RES.,FXD.CMPSPN:2K OHM,5%,0.25W	01121	CB2025
A14R1233	315-0432-00		RES.,FXD.CMPSPN:4.3K OHM,5%,0.25W	01121	CB4325
A14R1234	315-0122-00		RES.,FXD.CMPSPN:1.2K OHM,5%,0.25W	01121	CB1225
A14R1235	315-0122-00		RES.,FXD.CMPSPN:1.2K OHM,5%,0.25W	01121	CB1225
A14R1236	315-0131-00		RES.,FXD.CMPSPN:130 OHM,5%,0.25W	01121	CB1315
A14R1300	315-0200-00		RES.,FXD.CMPSPN:20 OHM,5%,0.25W	01121	CB2005
A14R1301	315-0102-00		RES.,FXD.CMPSPN:1K OHM,5%,0.25W	01121	CB1025
A14R1302	315-0102-00		RES.,FXD.CMPSPN:1K OHM,5%,0.25W	01121	CB1025
A14R1303	315-0102-00		RES.,FXD.CMPSPN:1K OHM,5%,0.25W	01121	CB1025
A14R1304	315-0512-00		RES.,FXD.CMPSPN:5.1K OHM,5%,0.25W	01121	CB5125
A14R1319	315-0151-00		RES.,FXD.CMPSPN:150 OHM,5%,0.25W	01121	CB1515
A14R1320	321-0201-00	B01010(B020319)	RES.,FXD.FILM:1.21K OHM,1%,0.125W (STANDARD ONLY)	91637	MFF1816G12100F
A14R1320	321-0222-00	B020320	RES.,FXD.FILM:2K OHM,1%,0.125W (STANDARD ONLY)	91637	MFF1816G20000F
A14R1320	321-0201-00	B01010(B020449)	RES.,FXD.FILM:1.21K OHM,1%,0.125W (OPTION 1 ONLY)	91637	MFF1816G12100F
A14R1320	321-0222-00	B020450	RES.,FXD,FILM:2K OHM,1%,0.125W (OPTION 1 ONLY)	91637	MFF1816G20000F
A14R1321	321-0414-00		RES.,FXD,FILM:200K OHM,1%,0.125W	91637	MFF1816G20002F
A14R1322	315-0102-00		RES.,FXD,CMPSPN:1K OHM,5%,0.25W	01121	CB1025
A14R1323	315-0101-00		RES.,FXD,CMPSPN:100 OHM,5%,0.25W	01121	CB1015
A14R1324	315-0561-00		RES.,FXD,CMPSPN:560 OHM,5%,0.25W	01121	CB5615
A14R1325	315-0561-00		RES.,FXD,CMPSPN:560 OHM,5%,0.25W	01121	CB5615
A14R1326	315-0121-00		RES.,FXD,CMPSPN:120 OHM,5%,0.25W	01121	CB1215
A14R1330	315-0561-00		RES.,FXD,CMPSPN:560 OHM,5%,0.25W	01121	CB5615
A14R1331	315-0561-00		RES.,FXD.CMPSPN:560 OHM,5%,0.25W	01121	CB5615
A14R1332	315-0561-00		RES.,FXD.CMPSPN:560 OHM,5%,0.25W	01121	CB5615
A14R1333	315-0561-00		RES.,FXD,CMPSPN:560 OHM,5%,0.25W	01121	CB5615
A14R1334	315-0221-00		RES.,FXD.CMPSPN:220 OHM,5%,0.25W	01121	CB2215
A14R1335	315-0221-00		RES.,FXD.CMPSPN:220 OHM,5%,0.25W	01121	CB2215
A14R1336	315-0122-00		RES.,FXD,CMPSPN:1.2K OHM,5%,0.25W	01121	CB1225
A14R1337	315-0122-00		RES.,FXD.CMPSPN:1.2K OHM,5%,0.25W	01121	CB1225
A14R1339	315-0302-00		RES.,FXD.CMPSPN:3K OHM,5%,0.25W	01121	CB3025
A14R1400	315-0101-00		RES.,FXD.CMPSPN:100 OHM,5%,0.25W	01121	CB1015
A14R1401	315-0273-00		RES.,FXD.CMPSPN:27K OHM,5%,0.25W	01121	CB2735

COMPONENT NO.	TEKTRONIX PART NO.	SERIAL/MODEL NO. EFF DSCONT	NAME & DESCRIPTION	MFR CODE	MFR PART NUMBER
A14R1410	311-2096-00 --*		RES.,VAR, NONNW: PANL, 1M OHM, 20%, 0.5W (FURNISHED AS A UNIT WITH A14S1410)	12697	SERIES 388
A14R1412	315-0123-00		RES.,FXD.CMPSN:12K OHM,5%,0.25W	01121	CB1235
A14R1420	311-1559-00		RES.,VAR, NONWIR:10K OHM,20%,0.50W	73138	91-81-0
A14R1421	315-0512-00		RES.,FXD.CMPSN:5.1K OHM,5%,0.25W	01121	CB5125
A14R1500	315-0470-00		RES.,FXD.CMPSN:47 OHM,5%,0.25W	01121	CB4705
A14R1501	315-0470-00		RES.,FXD.CMPSN:47 OHM,5%,0.25W	01121	CB4705
A14R1502	315-0470-00		RES.,FXD.CMPSN:47 OHM,5%,0.25W	01121	CB4705
A14R1503	315-0470-00		RES.,FXD.CMPSN:47 OHM,5%,0.25W	01121	CB4705
A14R1504	315-0470-00		RES.,FXD.CMPSN:47 OHM,5%,0.25W	01121	CB4705
A14R1505	315-0470-00		RES.,FXD.CMPSN:47 OHM,5%,0.25W	01121	CB4705
A14R1506	315-0470-00		RRES.,FXD.CMPSN:47 OHM,5%,0.25W	01121	CB4705
A14R1507	315-0470-00		RES.,FXD.CMPSN:47 OHM,5%,0.25W	01121	CB4705
A14R1508	315-0152-00		RES.,FXD.CMPSN:1.5K OHM,5%,0.25W	01121	CB1525
A14R1509	315-0512-00		RES.,FXD.CMPSN:5.1K OHM,5%,0.25W	01121	CB5125
A14R1511	315-0393-00		RES.,FXD.CMPSN:39K OHM,5%,0.25W	01121	CB3935
A14R1513	307-0541-00		RES.,NTWK,THK FI:(7)1K OHM,10%,1W	91637	MSP08A01-102G
A14R1520	315-0102-00		RES.,FXD.CMPSN:1K OHM,5%,0.25W	01121	CB1025
A14R1530	315-0123-00		RES.,FXD.CMPSN:12K OHM,5%,0.25W	01121	CB1235
A14R1531	315-0153-00		RES.,FXD.CMPSN:15K OHM,5%,0.25W	01121	CB1535
A14R1610	315-0103-00		RES.,FXD.CMPSN:10K OHM,5%,0.25W	01121	CB1035
A14R1614	315-0471-00		RES.,FXD.CMPSN:470 OHM,5%,0.25W	01121	CB4715
A14R1620	315-0102-00		RES.,FXD.CMPSN:1K OHM,5%,0.25W	01121	CB1025
A14R1622	315-0272-00		RES.,FXD.CMPSN:2.7K OHM,5%,0.25W	01121	CB2725
A14R1623	315-0272-00		RES.,FXD.CMPSN:2.7K OHM,5%,0.25W	01121	CB2725
A14R1624	315-0272-00		RES.,FXD.CMPSN:2.7K OHM,5%,0.25W	01121	CB2725
A14R1700	315-0103-00		RES.,FXD.CMPSN:10K OHM,5%,0.25W	01121	CB1035
A14R1701	315-0153-00 --*		RES.,FXD.CMPSN:15K OHM,5%,0.25W (STANDARD ONLY)	01121	CB1535
A14R1702	315-0122-00 --*		RES.,FXD.CMPSN:1.2K OHM,5%,0.25W (STANDARD ONLY)	01121	CB1225
A14R1710	315-0102-00 --*		RES.,FXD.CMPSN:1K OHM,5%,0.25W (STANDARD ONLY)	01121	CB1025
A14R1711	315-0562-00 --*		RES.,FXD.CMPSN:5.6K OHM,5%,0.25W (STANDARD ONLY)	01121	CB5625
A14R1712	315-0181-00 --*		RES.,FXD.CMPSN:180 OHM,5%,0.25W (STANDARD ONLY)	01121	CB1815
A14R1713	315-0122-00		RES.,FXD.CMPSN:1.2K OHM,5%,0.25W	01121	CB1225
A14R1714	315-0111-00		RES.,FXD.CMPSN:110 OHM,5%,0.25W	01121	CB1115
A14R1715	315-0272-00		RES.,FXD.CMPSN:2.7K OHM,5%,0.25W	01121	CB2725
A14R1719	315-0472-00		RES.,FXD.CMPSN:4.7K OHM,5%,0.25W	01121	CB4725
A14R1720	315-0471-00		RES.,FXD.CMPSN:470 OHM,5%,0.25W	01121	CB4715
A14R1721	307-0103-00		RES.,FXD.CMPSN:2.7 OHM,5%,0.25W	01121	CB27G5
A14R1723	315-0362-00		RES.,FXD.CMPSN:3.6K OHM,5%,0.25W	01121	CB3625
A14R1724	315-0102-00		RES.,FXD.CMPSN:1K OHM,5%,0.25W	01121	CB1025
A14R1725	315-0241-00		RES.,FXD.CMPSN:240 OHM,5%,0.25W	01121	CB2415
A14R1730	321-0282-00		RES.,FXD.FILM:8.45K OHM,1%,0.125W	91637	MFF1816G84500F
A14R1731	315-0821-00		RES.,FXD.CMPSN:820 OHM,5%,0.25W	01121	CB8215
A14R1732	315-0271-00		RES.,FXD.CMPSN:270 OHM,5%,0.25W	01121	CB2715
A14R1733	308-0244-00		RES.,FXD.WW:0.3 OHM,10%,2W	91637	RS2B162ER3000K
A14R1734	315-0162-00		RES.,FXD.CMPSN:1.6K OHM,5%,0.25W	01121	CB1625
A14R1735	315-0181-00		RES.,FXD.CMPSN:180 OHM,5%,0.25W	01121	CB1815
A14R1736	315-0100-00		RES.,FXD.CMPSN:10 OHM,5%,0.25W	01121	CB1005
A14R1800	315-0121-00		RES.,FXD.CMPSN:120 OHM,5%,0.25W	01121	CB1215
A14R1801	321-0105-00 --*		RES.,FXD.FILM:121 OHM,1%,0.125W (OPTION 1 ONLY)	91637	MFF1816G121R0F
A14R1802	315-0241-00		RES.,FXD.CMPSN:240 OHM,5%,0.25W	01121	CB2415

COMPONENT NO.	TEKTRONIX PART NO.	SERIAL/MODEL NO. EFF DSCONT	NAME & DESCRIPTION	MFR CODE	MFR PART NUMBER
A14R1803	321-0213-00	-*-	RES.,FXD,FILM:1.62K OHM,1%,0.125W (OPTION 1 ONLY)	91637	MFF1816G16200F
A14R1810	315-0100-00		RES.,FXD,CMPNS:10 OHM,5%,0.25W	01121	CB1005
A14R1820	315-0132-00		RES.,FXD,CMPNS:1.3K OHM,5%,0.25W	01121	CB1325
A14R1821	315-0152-00		RES.,FXD,CMPNS:1.5K OHM,5%,0.25W	01121	CB1525
A14R1822	315-0101-00		RES.,FXD,CMPNS:100 OHM,5%,0.25W	01121	CB1015
A14R1823	315-0102-00		RES.,FXD,CMPNS:1K OHM,5%,0.25W	01121	CB1025
A14R1824	315-0472-00		RES.,FXD,CMPNS:4.7K OHM,5%,0.25W	01121	CB4725
A14R1825	321-0260-00		RES.,FXD,FILM:4.99K OHM,1%,0.125W	91637	MFF1816G49900F
A14R1826	321-0225-00		RES.,FXD,FILM:2.15K OHM,1%,0.125W	91637	MFF1816G21500F
A14R1827	321-0260-00		RES.,FXD,FILM:4.99K OHM,1%0.125W	91637	MFF1816G49900F
A14R1828	315-0102-00		RES.,FXD,CMPNS:1K OHM,5%,0.25W	01121	CB1025
A14S1010	263-0074-00		SW LEVER ASSY:	80009	263-0074-00
A14S1020	263-0010-00		SWITCH PB ASSY:1 PUSH,7.5MM,W/2 CONTACTS	80009	263-0010-00
A14S1021	263-0010-00		SWITCH PB ASSY:1 PUSH,7.5MM,W/2 CONTACTS	80009	263-0010-00
A14S1030	263-0010-00		SWITCH PB ASSY:1 PUSH,7.5MM,W/2 CONTACTS	80009	263-0010-00
A14S1031	263-0010-00		SWITCH PB ASSY:1 PUSH,7.5MM,W/2 CONTACTS	80009	263-0010-00
A14S1310	260-1737-02		SWITCH,PUSH:2 BTN,2 POLE,PUSH	80009	260-1737-02
A14S1311	-*-		(PART OF A14S1310)		
A14S1410	-*-		(PART OF A14R1410)		
A14U1200	160-0893-00		MICROCIRCUIT,DI:32 X 8 PROM,PROGRAMMED	80009	160-0893-00
A14U1220	156-1149-00		MICROCIRCUIT,LI:OPERATIONAL AMP,JFET INPUT	27014	LF351N
A14U1300	160-0892-00		MICROCIRCUIT,DI:32 X 8 PROM,PROGRAMMED	80009	160-0892-00
A14U1330	156-0369-00		MICROCIRCUIT,DI:TRIPLE LINE RECEIVER	80009	156-0369-00
A14U1400	156-0994-00		MICROCIRCUIT,DI:8 INPUT DATA SEL/MUX	01295	SN74LS151N OR J
A14U1401	156-1407-00		MICROCIRCUIT,DI:MOS-TO-LED 8-DIGIT DRIVER	80009	156-1407-00
A14U1420	156-0383-00		MICROCIRCUIT,DI:QUAD 2-INPUT NOR GATE	80009	156-0383-00
A14U1421	156-0578-00		MICROCIRCUIT,DI:DUAL 1 SHOT MULTIVIBRATOR	80009	156-0578-00
A14U1422	156-0382-00		MICROCIRCUIT,DI:QUAD 2-INPUT NAND GATE	01295	SN74LS00(N OR J)
A14U1423	156-0578-00		MICROCIRCUIT,DI:DUAL 1 SHOT MULTIBRATOR	80009	156-0578-00
A14U1520	156-1411-00		MICROCIRCUIT,DI:6 DECADE CNTR W/8 DECADE	80009	156-1411-00
A14U1610	156-0795-00		MICROCIRCUIT,DI:BCD 7-SEG LCHDGR/DRVR	04713	MC14511BCL
A14U1611	156-0852-00		MICROCIRCUIT,DI:HEX BUS DRIVER W/3-STATE	01295	SN74LS367 N OR J
A14U1620	156-0656-00		MICROCIRCUIT,DI:DECADE COUNTER	01295	SN74LS90N OR J
A14U1621	156-0385-00		MICROCIRCUIT,DI:HEX INVERTER	80009	156-0385-00
A14U1800	156-1161-00		MICROCIRCUIT,LI:VOLTAGE REGULATOR (OPTION 1 ONLY)	27014	LM317T
A14U1830	156-0285-02		MICROCIRCUIT,LI:VOLTAGE REGULATOR	27014	LM340T-12
A14U1831	156-0071-00		MICROCIRCUIT,LI:VOLTAGE REGULATOR	04713	MC1723CL
A14VR1710	152-0149-00		SEMICONV DEVICE:ZENER,0.4W,10V,5% (STANDARD ONLY)	04713	SZG35009K3
A14Y1710	119-0894-01		OSCILLATOR,RF:10MHZ,18V (OPTION 1 ONLY)	80009	119-0894-01
A14Y1810	158-0129-00		XTAL UNIT,QTZ:10MHZ,0.001%,PARALLEL (STANDARD ONLY)	33096	PB1109

COMPONENT NO.	TEKTRONIX PART NO.	SERIAL/MODEL NO.		NAME & DESCRIPTION	MFR CODE	MFR PART NUMBER
		EFF	DSCONT			
				CHASSIS PARTS		
J510	131-0955-00			CONN,RCPT,ELEC:BNC,FEMALE	13511	31-279
J520	136-0387-00			JACK,TIP:GRAY	71279	450-4352-01-0318
J530	136-0387-00			JACK,TIP:GRAY	71279	450-4352-01-0318
J540	136-0387-00			JACK,TIP:GRAY	71279	450-4352-01-0318
J610	131-0955-00			CONN,RCPT,ELEC:BNC,FEMALE	13511	31-279
J620	136-0387-00			JACK,TIP:GRAY	71279	450-4352-01-0318
J630	136-0387-00			JACK,TIP:GRAY	71279	450-4352-01-0318
R500	311-2095-00			RES.,VAR.NONWIR:PNL,10K OHM,10%	12697	SERIES 388
R600	311-2095-00			RES.,VAR.NONWIR:PNL,10K OHM,10%	12697	SERIES 388

DIAGRAMS AND CIRCUIT BOARD ILLUSTRATIONS

Symbols

Graphic symbols and class designation letters are based on ANSI Standard Y32.2-1975.

Logic symbology is based on ANSI Y32.14-1973 in terms of positive logic. Logic symbols depict the logic function performed and may differ from the manufacturer's data.

The overline on a signal name indicates that the signal performs its intended function when it is in the low state.

Abbreviations are based on ANSI Y1.1-1972.

Other ANSI standards that are used in the preparation of diagrams by Tektronix, Inc. are:

- Y14.15, 1966 Drafting Practices.
- Y14.2, 1973 Line Conventions and Lettering.
- Y10.5, 1968 Letter Symbols for Quantities Used in Electrical Science and Electrical Engineering.

American National Standard Institute
1430 Broadway
New York, New York 10018

Component Values

Electrical components shown on the diagrams are in the following units unless noted otherwise:

- Capacitors = Values one or greater are in picofarads (pF).
Values less than one are in microfarads (μ F).
- Resistors = Ohms (Ω).

— The information and special symbols below may appear in this manual.—

Assembly numbers and Grid Coordinates

Each assembly in the instrument is assigned an assembly number (e.g., A20). The assembly number appears on the circuit board outline on the diagram, in the title for the circuit board component location illustration, and in the lookup table for the schematic diagram and corresponding component locator illustration. The Replaceable Electrical Parts list is arranged by assemblies in numerical sequence; the components are listed by component number *(see following illustration for Constructing a component number).

The schematic diagram and circuit board component location illustration have grids. A lookup table with the grid coordinates is provided for ease of locating the component. Only the components illustrated on the facing diagram are listed in the lookup table. When more than one schematic diagram is used to illustrate the circuitry on a circuit board, the circuit board illustration may only appear opposite the first diagram on which it was illustrated; the lookup table will list the diagram number of other diagrams that the circuitry of the circuit board appears on.

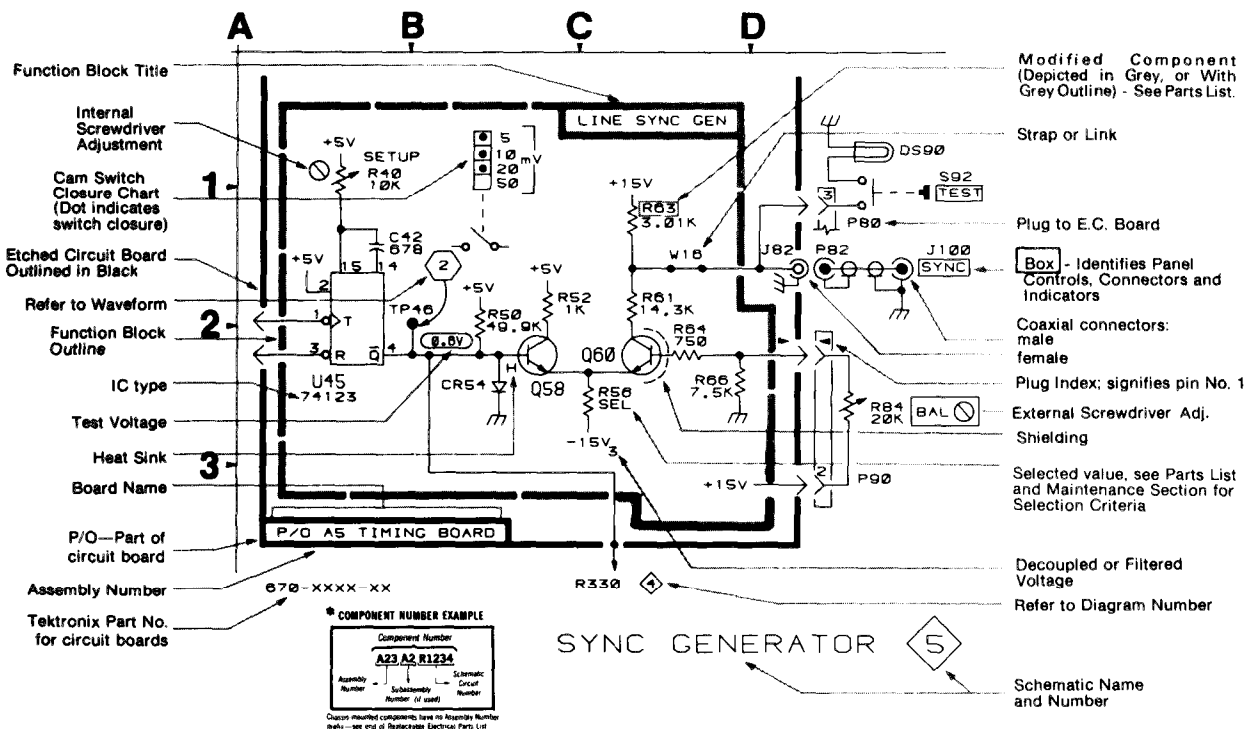

SEE END OF MPL FOR WIRE ASSEMBLIES

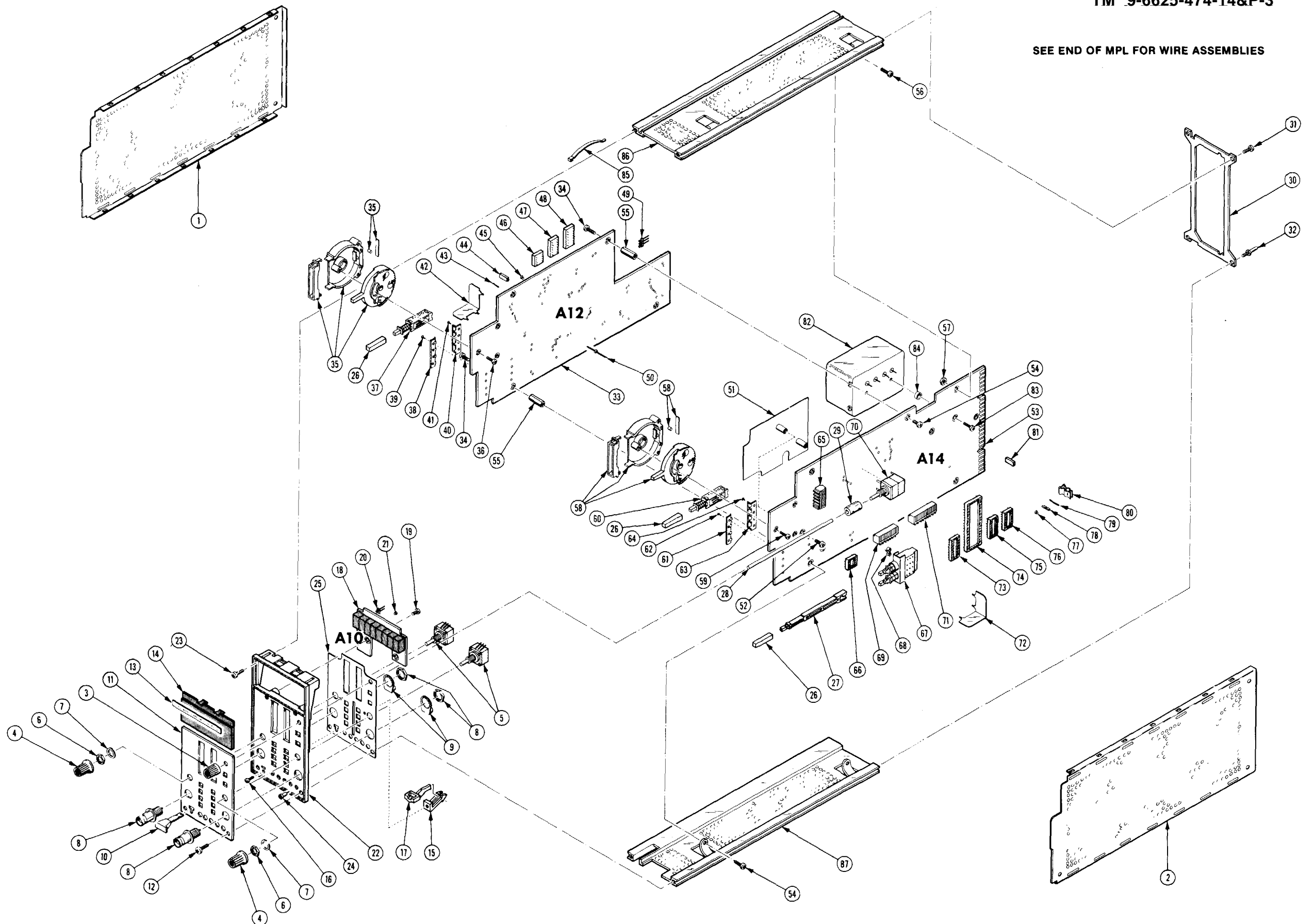

DC 503A UNIVERSAL TIMER/COUNTER EXPLODED VIEW

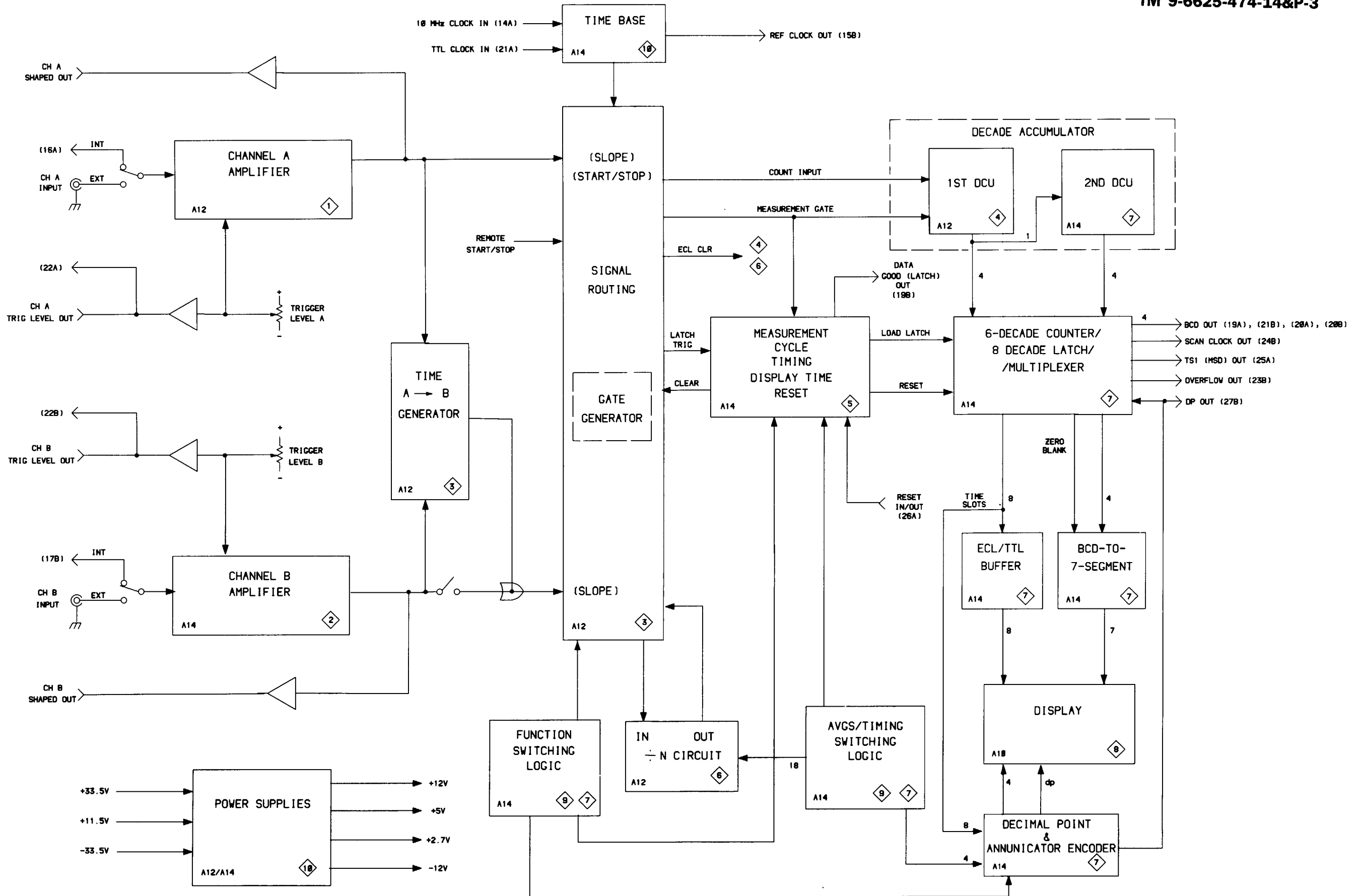

DC503A BLOCK DIAGRAM

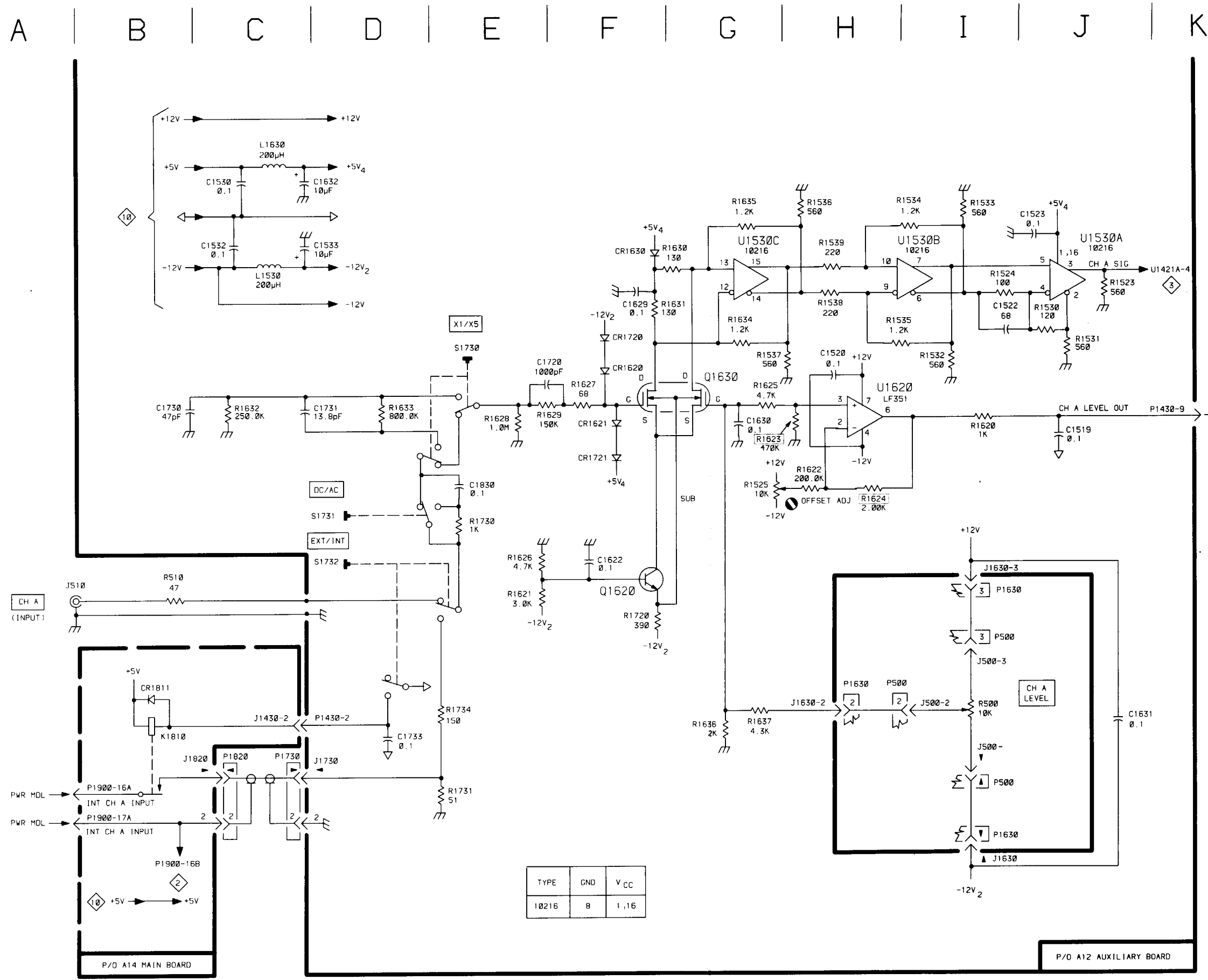

SEE PARTS LIST FOR EARLIER VALUES AND SERIAL NUMBER RANGES OF PARTS OUTLINED OR DEPICTED IN GREY.

Static Sensitive Devices
See Maintenance Section
COMPONENT NUMBER EXAMPLE

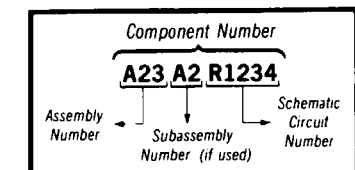

Chassis-mounted components have no Assembly Number prefix—see end of Replaceable Electrical Parts List.

DC 503A

CH A AMPLIFIER

1

PARTS LOCATION GRID

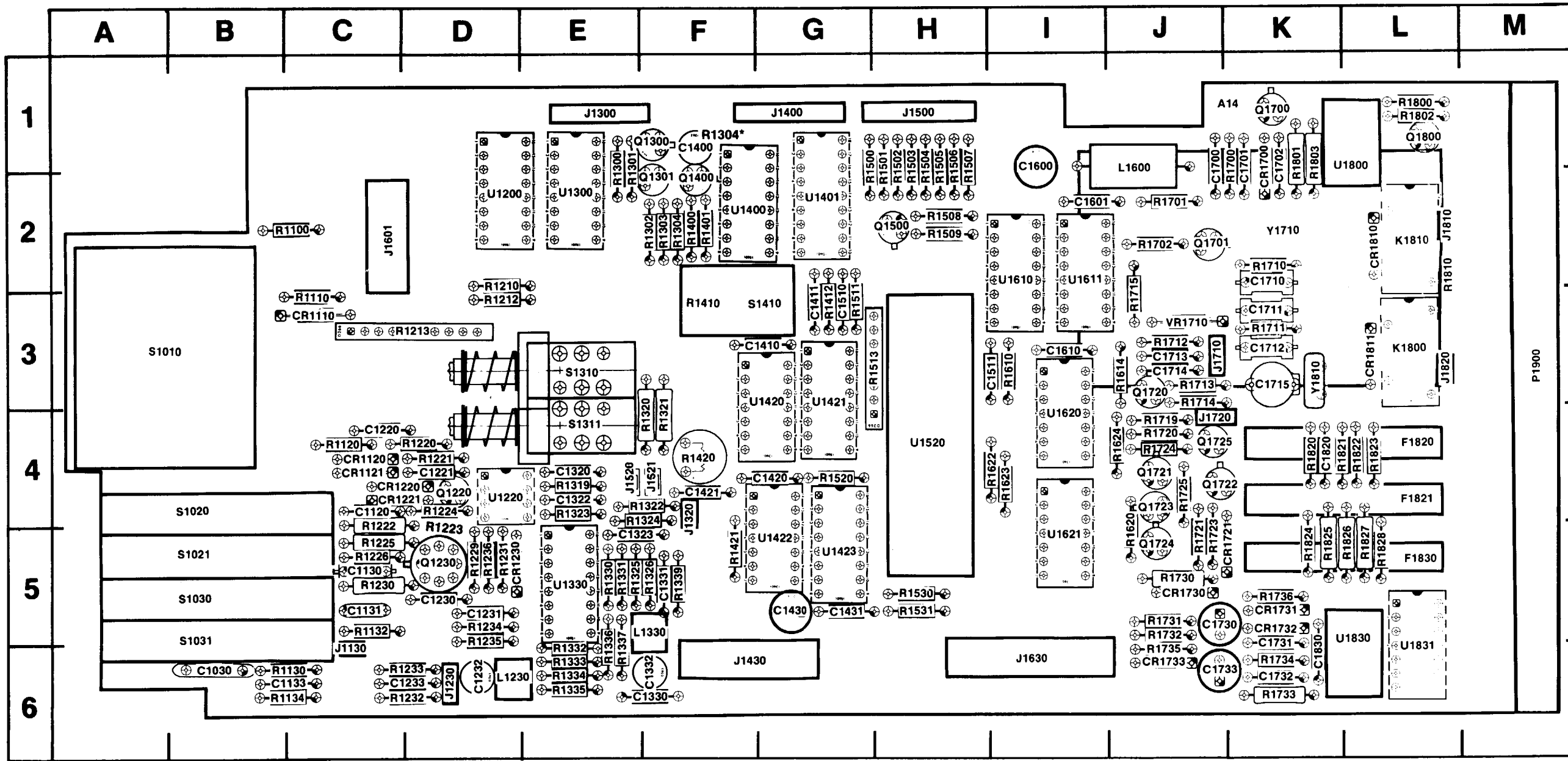

Fig. 8-4. Main Board (A14 Assy).

2971-19

Table 8-2
COMPONENT REFERENCE CHART (See Fig. 8-4)

P/O A14 ASSY			CH B AMPLIFIER 2		
Circuit Number	Schematic Location	Board Location	Circuit Number	Schematic Location	Board Location
C1030	D5	B6	R1130	D5	C6
C1120	E4	C4	R1132	D7	C5
C1130	B4	C5	R1134	D6	C6
C1131	C4	C5	R1220	E5	D4
C1133	C6	C6	R1221	E5	D4
C1220	E6	C4	R1222	D4	C4
C1221	E5	D4	R1223	H4	D4
C1230	F4	D5	R1224	E4	D4
C1231	E3	D5	R1225	C4	C5
C1233	L6	D6	R1226	E4	C5
C1320	J4	E4	R1229	F4	D5
C1322	J3	E4	R1230	F4	C5
C1323	K3	E5	R1231	D3	D5
C1421	K4	F4	R1232	F6	D6
			R1233	H6	D6
CR1120	E3	C4	R1234	F3	D5
CR1121	E4	C4	R1235	F3	D5
CR1220	E4	C4	R1236	F3	D5
CR1221	E4	C4	R1304*	H6	F1
CR1230	E3	D5	R1319	K3	E4
CR1810	C6	L2	R1320	H5	F4
			R1321	H5	F4
J610	B6	CHASSIS	R1322	J4	F4
J620	L3	CHASSIS	R1323	J3	E4
J630	L3	CHASSIS	R1324	K3	F4
J1130	D7	C6	R1325	K4	E5
J1230	J6	D6	R1326	J3	F5
J1320	L3	F4	R1330	J4	E5
J1430	B1	F6	R1331	J2	E5
J1520	L2	E4	R1332	H2	E6
J1521	L2	F4	R1333	H4	E6
J1810	C7	L2	R1334	H3	E6
			R1335	H3	E6
K1800	B6	L3	R1336	H3	E6
			R1337	H3	E6
P1130	C7	C6	R1337	H3	E6
P1230	J6	D6	R1420	H5	F4
P1320	L3	F4	R1820	C8	L2
P1810	C7	L2			
P1900	L1	M1	S1021	D4	B5
P1900	L4	M1	S1030	D5	B5
P1900	B7	M1	S1031	D5	B5
Q1220	E5	D4	U1220	H4	D4
Q1230	F4	D5	U1330A	F3	E5
R610	C6	CHASSIS	U1330B	H3	E5
R1120	F6	C4	U1330C	K3	E5

P/O A14 ASSY also shown on 1 3 5 7 9 10

* Located on back of board.

* Located on back of board

Static Sensitive Devices
See Maintenance Section

COMPONENT NUMBER EXAMPLE

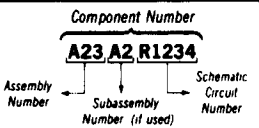

Chassis-mounted components have no Assembly Number prefix—see end of Replaceable Electrical Parts List

A | B | C | D | E | F | G | H | I | J | K

1
2
3
4
5
6
7
8

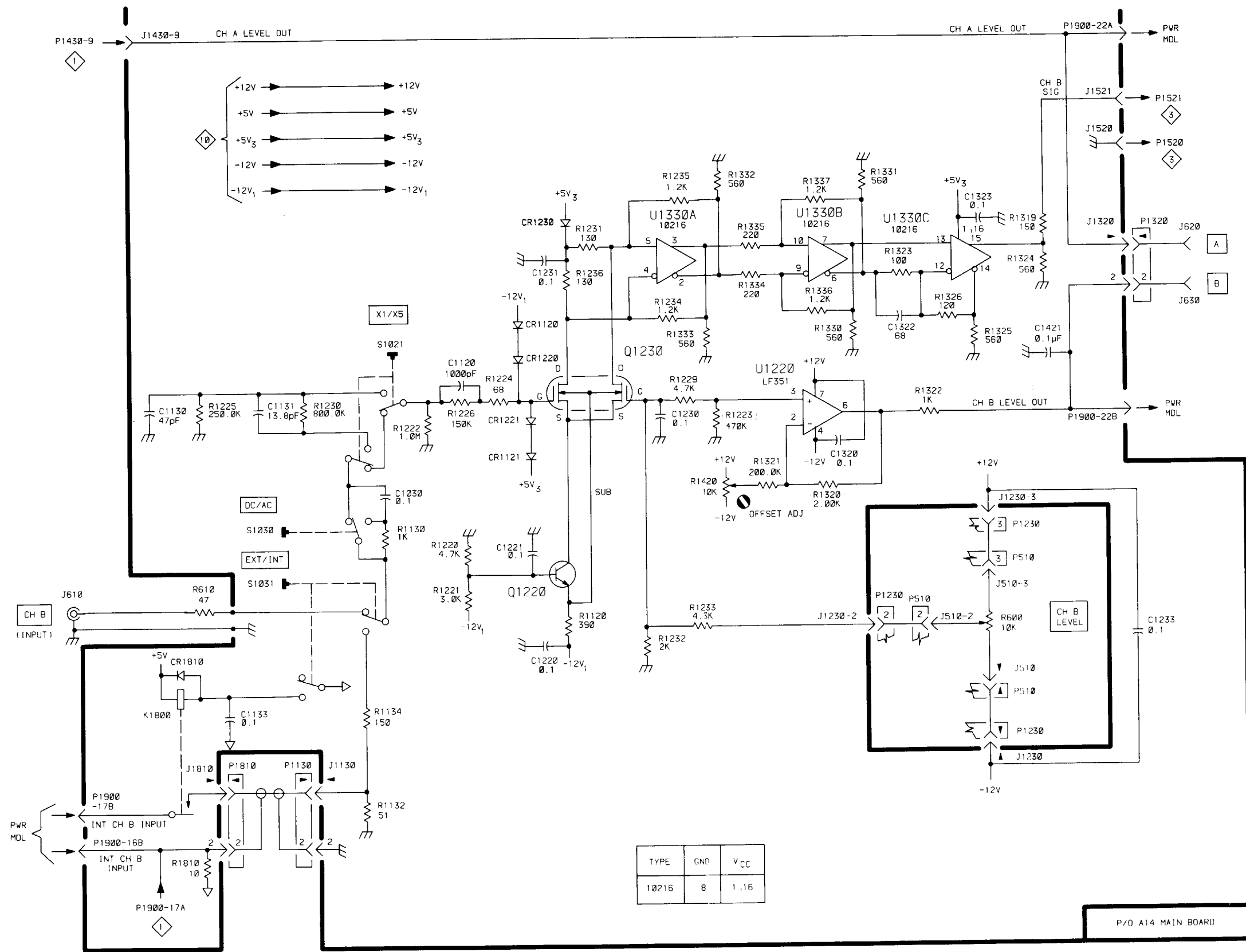

TYPE	GND	V _{CC}
10216	8	1, 16

Static Sensitive Devices
See Maintenance Section
COMPONENT NUMBER EXAMPLE

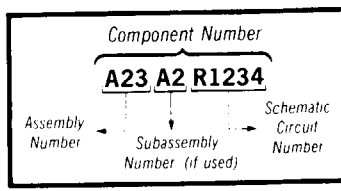

Chassis mounted components have no Assembly Number prefix—see end of Replaceable Electrical Parts List.

DC 503A

REV. A JAN 1991

2971-22

CH B AMPLIFIER

2

DD

8-15/(8-16 blank)

Table 8-3
COMPONENT REFERENCE CHART (See Fig. 8-3)

P/O A12 ASSY			SIGNAL ROUTING, TIME A-B GENERATOR & GATE GENERATOR			3
Circuit Number	Schematic Location	Board Location	Circuit Number	Schematic Location	Board Location	
C1310	L8	F3	R1332	H5	F5	
C1311	J8	E3	R1333	E5	F5	
C1331	H3	F5	R1334	H5	F5	
C1420	K8	G3	R1336	C5	F6	
C1430	J7	G5	R1420A	E2	G4	
J520	M1	CHASSIS	R1420B	F4	G4	
J530	M4	CHASSIS	R1420C	E5	G4	
J540	M7	CHASSIS	R1420D	E3	G4	
J1519	L1	H4	R1420E	D5	G4	
J1530	L7	H5	R1420F	C2	G4	
P1430	A6	G6	R1420G	D4	G4	
P1430	C5	G6	R1420H	D2	G4	
P1519	L1	H4	R1430	K7	G5	
P1520	A6	H4	R1431	J7	G5	
P1521	A6	H4	R1520	E1	H4	
P1530	L7	H5	R1521	H1	H4	
P1630	L4	D6	S1720	B2	L4	
P1630	B2	D6	U1122D	L4	C5	
Q1134	K3	D5	U1220C	K2	D4	
Q1320	H5	F5	U1220D	K3	D4	
Q1321	H5	F5	U1320C	F4	E4	
Q1330	H4	F5	U1320D	J6	E4	
Q1331	F5	F5	U1321	D4	F4	
Q1420	F1	H3	U1330A	H2	E5	
Q1530	J7	H5	U1330B	F3	E5	
R1130	K4	C6	U1330C	H3	E5	
R1134	L4	C6	U1330D	K4	E5	
R1138	L3	D6	U1410A	J5	G3	
R1210	D6	E2	U1410B	K5	G3	
R1211	D6	E2	U1420A	E5	G4	
R1220B	F3	E4	U1420B	D4	G4	
R1220C	J2	E4	U1420C	D3	G4	
R1220D	J4	E4	U1420D	E2	G4	
R1220E	J4	E4	U1421A	C2	G4	
R1220F	J2	E4	U1421B	C6	G4	
R1230	K3	D5	U1421C	F5	G4	
R1312	J4	F3	U1430A	E2	G5	
R1331	H4	F5	U1430B	E4	G5	
			U1430C	E4	G5	
			W1320	D4	F4	

P/O A12 ASSY also shown on 1 4 6 9 10

P/O A14 ASSY (See Fig. 8-4)					
R1339	B3	F5	S1020	B5	B4
			S1311	B3	E4

P/O A14 ASSY also shown on 1 2 5 7 9 10

A | B | C | D | E | F | H | J | K | L | M

1
2
3
4
5
6
7
8

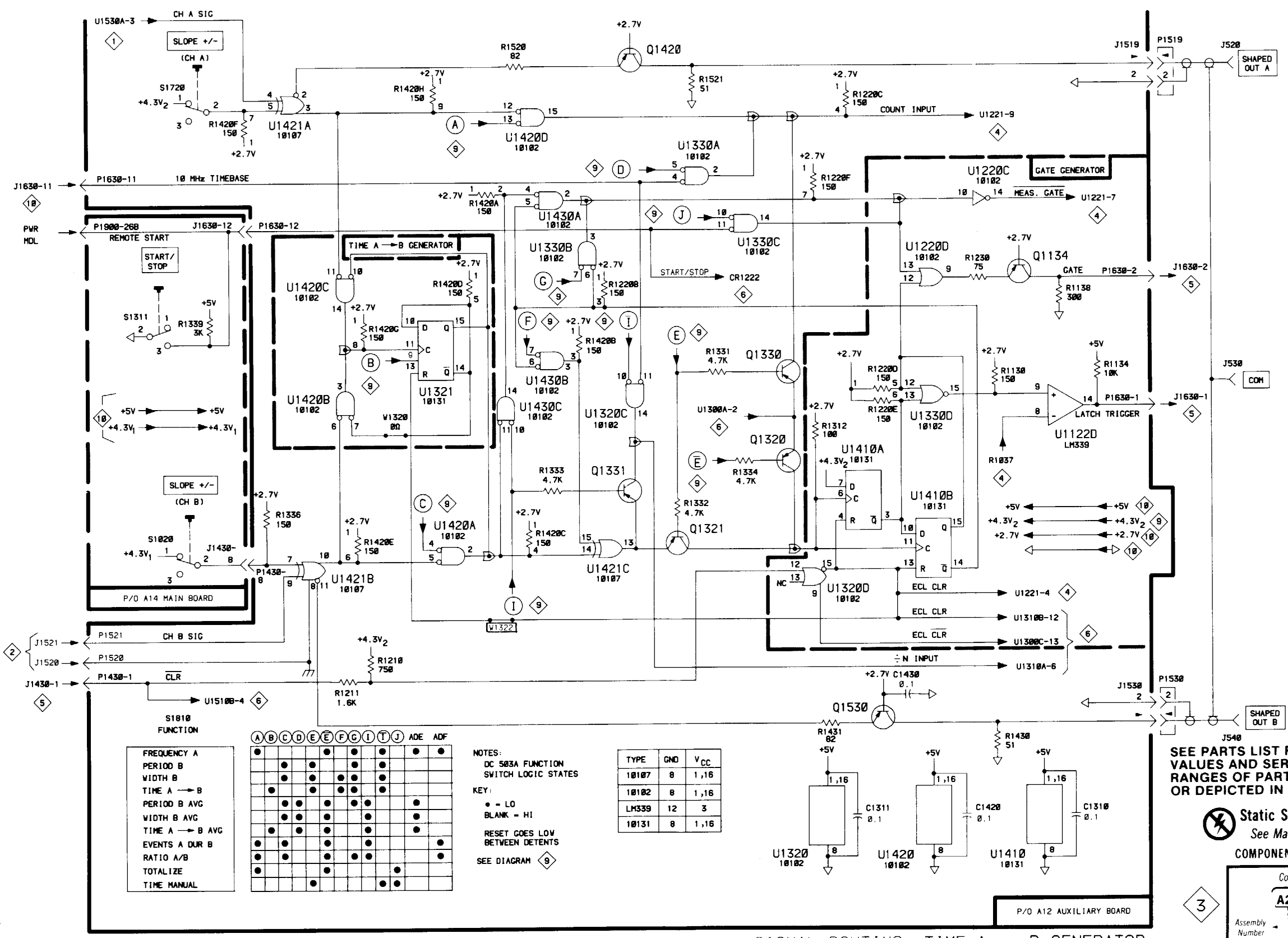

FUNCTION

	A	B	C	D	E	F	G	H	I	J	AD	ADF
FREQUENCY A	•	•	•	•	•	•	•	•	•	•	•	•
PERIOD B	•	•	•	•	•	•	•	•	•	•	•	•
WIDTH B	•	•	•	•	•	•	•	•	•	•	•	•
TIME A → B	•	•	•	•	•	•	•	•	•	•	•	•
PERIOD B AVG	•	•	•	•	•	•	•	•	•	•	•	•
WIDTH B AVG	•	•	•	•	•	•	•	•	•	•	•	•
TIME A → B AVG	•	•	•	•	•	•	•	•	•	•	•	•
EVENTS A DUR B	•	•	•	•	•	•	•	•	•	•	•	•
RATIO A/B	•	•	•	•	•	•	•	•	•	•	•	•
TOTALIZE	•	•	•	•	•	•	•	•	•	•	•	•
TIME MANUAL	•	•	•	•	•	•	•	•	•	•	•	•

NOTES:
DC 503A FUNCTION
SWITCH LOGIC STATES

KEY:
• - LO
BLANK - HI

RESET GOES LOW
BETWEEN DETENTS

SEE DIAGRAM 9

TYPE	GND	V _{CC}
10107	8	1, 16
10102	8	1, 16
LM339	12	3
10131	8	1, 16

SIGNAL ROUTING, TIME A → B GENERATOR, & GATE GENERATOR

SEE PARTS LIST FOR EARLIER VALUES AND SERIAL NUMBER RANGES OF PARTS OUTLINED OR DEPICTED IN GREY.



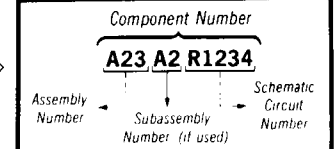

Static Sensitive Devices
See Maintenance Section
COMPONENT NUMBER EXAMPLE



Chassis mounted components have no Assembly Number prefix--see end of Replaceable Electrical Parts List

Table 8-4
COMPONENT REFERENCE CHART (See Fig. 8-3)

P/O A12 ASSY			DECADE ACCUMULATOR (1ST DCU) 		
Circuit Number	Schematic Location	Board Location	Circuit Number	Schematic Location	Board Location
C1120	B8	C4	R1038	F4	B5
C1220	C8	D4	R1131	E2	C6
P1630	M3	E6	R1132	K5	C6
Q1132	H4	C5	R1133	L7	C6
Q1133	F5	C5	R1220A	B2	E4
R1021A	K6	B4	R1231	F5	D5
R1021D	J5	B4	U1120	E4	C4
R1021E	C7	B4	U1121A	K7	C4
R1021G	E4	B4	U1121B	J6	C4
R1021H	D4	B4	U1122A	D2	C5
R1021I	F4	B4	U1122B	K6	C5
R1036	C2	B5	U1122C	L7	C5
R1037	C1	B5	U1220B	J8	D4
			U1221	C3	D4

P/O A12 ASSY also shown on     

A | B | C | D | E | F | G | H | I | J | K

1
2
3
4
5
6
7
8

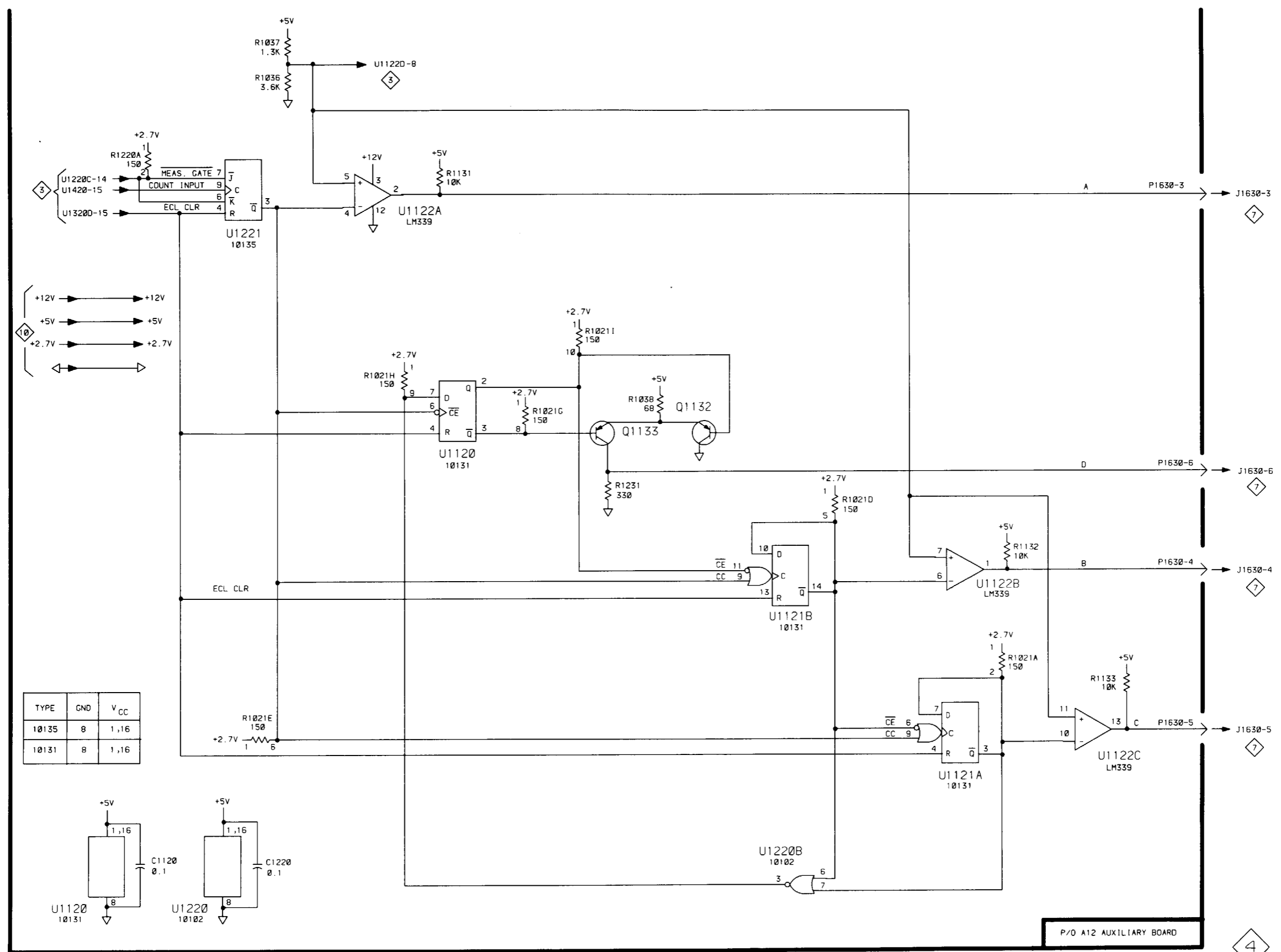

DC 503A

P/O A12 AUXILIARY BOARD
DECADE ACCUMULATOR
(1ST DCU)

Static Sensitive Devices
See Maintenance Section
COMPONENT NUMBER EXAMPLE

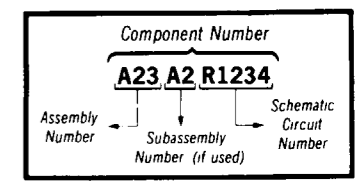







Chassis-mounted components have no Assembly Number prefix—see end of Replaceable Electrical Parts List.

8-23/(8-24 blank)

**Table 8-5
COMPONENT REFERENCE CHART (See Fig. 8-4)**

P/O A14 ASSY			MEASUREMENT CYCLE TIMING 		
Circuit Number	Schematic Location	Board Location	Circuit Number	Schematic Location	Board Location
C1400	E5	F1	R1400	E4	F2
C1411	K4	G3	R1401	D4	F2
C1430	K7	G5	R1410	D4	F3
C1431	K2	G5	R1412	K4	G3
C1510	K6	G3	R1421	C1	F5
C1701	C3	K1	R1511	K6	G3
CR1700	C3	K1	R1520	J3	G4
Q1300	E4	F1	R1530	K2	H5
Q1301	D5	F2	R1531	K7	H5
Q1400	D5	F2	R1700	C3	K1
Q1700	D3	K1	S1310	C3	E3
R1300	F5	E1	S1410	D3	G3
R1301	F5	E1	U1420	K8	G3
R1302	H4	F2	U1421	K5	G3
R1303	F4	F2	U1422	H4	G5
R1304	C5	F2	U1423	K3	G5

P/O A14 ASSY also shown on      

A | B | C | D | E | F | H | J | K | L | M

1
2
3
4
5
6
7
8

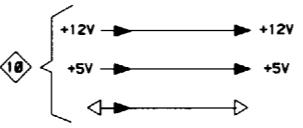
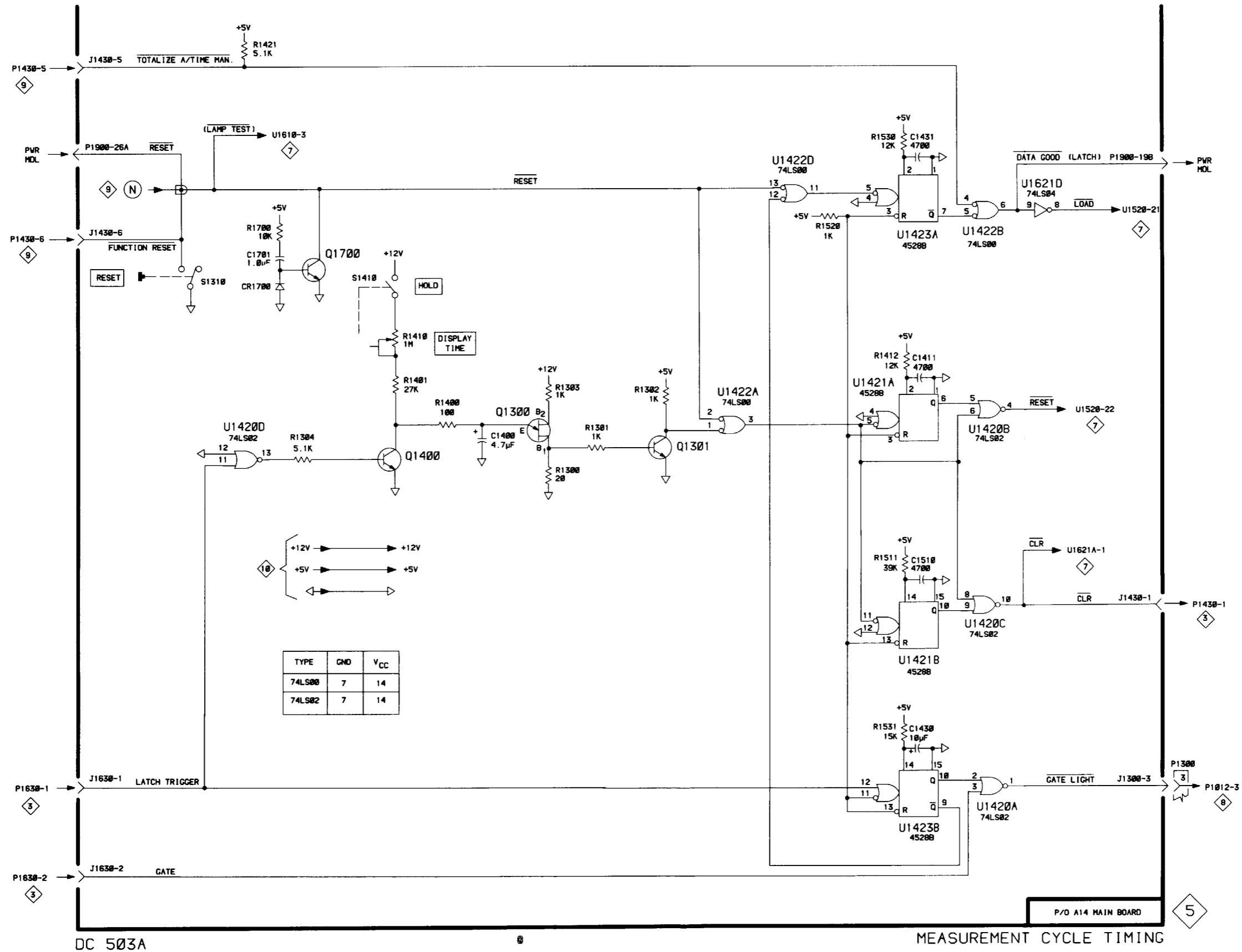

TYPE	GND	V _{CC}
74LS00	7	14
74LS02	7	14

Static Sensitive Devices
See Maintenance Section

COMPONENT NUMBER EXAMPLE

Component Number		
A23 A2 R1234		
Assembly Number	Subassembly Number (if used)	Schematic Circuit Number

Chassis mounted components have no Assembly Number prefix—see end of Replaceable Electrical Parts List

DC 503A

MEASUREMENT CYCLE TIMING

DC 503A

Table 8-6
COMPONENT REFERENCE CHART (See Fig. 8-3)

P/O A12 ASSY			N CIRCUIT 6		
Circuit Number	Schematic Location	Board Location	Circuit Number	Schematic Location	Board Location
C1200	H8	E2	U1220A	H6	D4
C1202	M2	E2	U1330A	M3	E2
C1400	H8	F1	U1300B	K8	E2
C1510	J8	H2	U1300C	D8	E2
C1600	F8	I1	U1310A	E7	E3
CR1220	E6	E4	U1310B	F7	E3
CR1222	D7	E4	U1320A	B8	E4
P1601	B1	J2	U1320B	H6	E4
P1601	B8	J2	U1400	F4	G2
Q1300	E7	F1	U1401	H3	G2
R1021F	F5	B4	U1411A	H7	G3
R1200	L3	E2	U1411B	K7	G3
R1215	D6	E3	U1430D	F6	G5
R1220G	J7	E4	U1500	L3	H2
R1220H	F5	E4	U1501	H2	H2
R1220I	H6	E4	U1510A	C3	H3
R1300	F7	F2	U1510B	C4	H3
R1301	E7	F2	U1510C	C3	H3
R1302	L3	F2	U1510D	C2	H3
R1303	L3	F2	U1511A	C2	H3
R1310B	D7	F3	U1511B	C1	H3
R1310C	E7	F3	U1511C	K1	H3
R1310D	D7	F3	U1511D	C1	H3
R1310F	C8	F3	U1600A	K1	I2
R1310G	C8	F3	U1600B	E5	I2
R1310H	K7	F3	U1610	J1	I3
R1310I	K8	F3			
R1420I	H5	G4			

P/O A12 ASSY also shown on 1 3 4 9 10

A | B | C | D | E | F | H | J | K | L | M

1
2
3
4
5
6
7
8

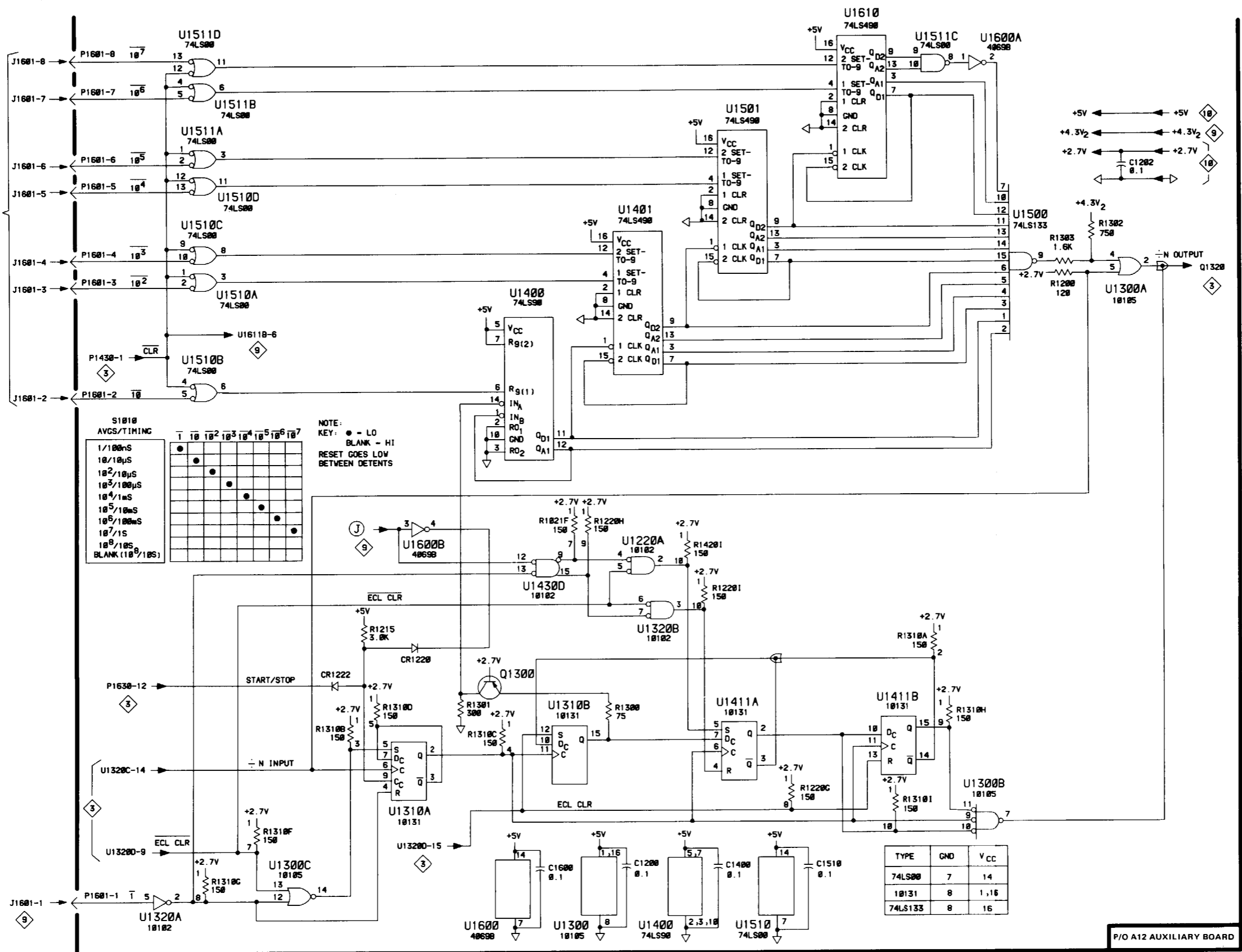

DC 503A

P/O A12 AUXILIARY BOARD
N CIRCUIT

Static Sensitive Devices
See Maintenance Section
COMPONENT NUMBER EXAMPLE

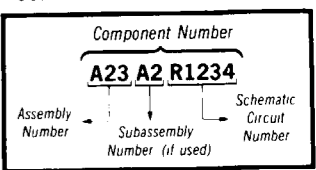

Chassis-mounted components have no Assembly Number prefix—see end of Replaceable Electrical Parts List

6

Table 8-7
COMPONENT REFERENCE CHART (See Fig. 8-4)

P/O A14 ASSY			6-DECADE COUNTER, 8-DECADE LATCH/MULTIPLEXER		
Circuit Number	Schematic Location	Board Location	Circuit Number	Schematic Location	Board Location
C1511	D2	I3	R1505	K2	H1
C1601	J7	I2	R1506	K2	H1
J1300	M6	E1	R1507	K7	H1
J1300	M8	E1	R1508	K6	H2
J1400	M4	G1	R1509	J7	H2
J1430	B9	F6	R1513	H4	H3
J1500	M7	H1	R1610	D2	I3
J1500	M2	H1	R1622	D4	I4
J1630	B3	I6	R1623	D4	I4
			R1624	D4	J4
P1300	M6	E1	R1715	D4	J3
P1300	M8	E1	R1800	J6	L1
P1400	M4	G1	R1802	B2	L2
P1500	M2	H1	U1200	D7	D2
P1500	M7	H1	U1300	D8	E2
P1900	L1	M3	U1400	H6	F2
P1900	L6	M3	U1401	J4	G2
P1900	B2	M3	U1520	E4	H4
P1900	L5	M3	U1610	K3	I2
Q1500	K7	H2	U1611A	F5	I2
Q1800	C2	L2	U1611B	K5	I2
R1500	K4	H1	U1611C	J2	I2
R1501	K3	H1	U1611D	F2	I2
R1502	K3	H1	U1611E	H2	I2
R1503	K3	H1	U1611F	H2	I2
R1504	K2	H1	U1620	C5	I4
			U1621A	B5	I5
			U1621B	L6	I5

P/O A14 ASSY also shown on

- 1 2 3 5 9 10

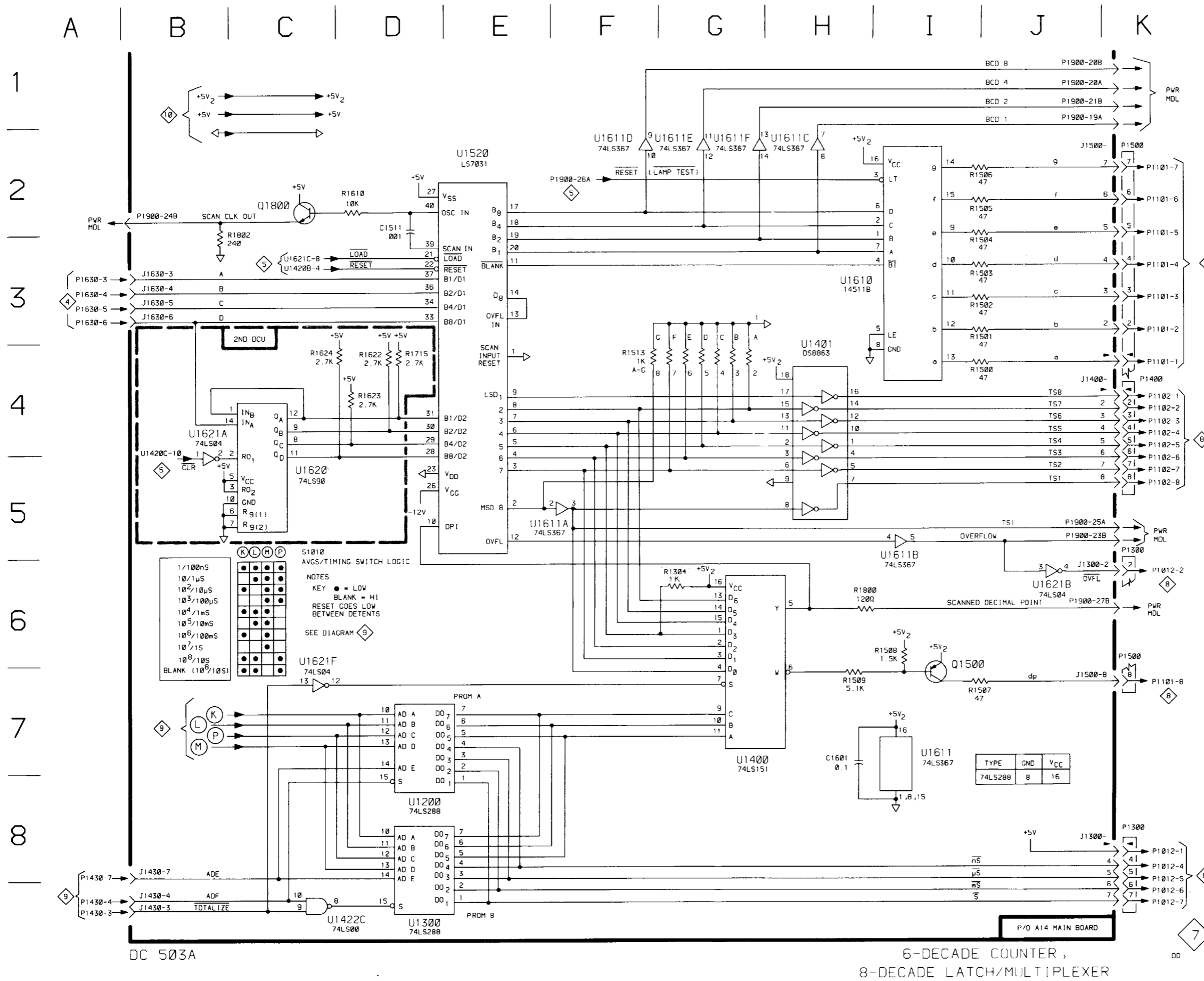

SEE PARTS LIST FOR EARLIER VALUES AND SERIAL NUMBER RANGES OF PARTS OUTLINED OR DEPICTED IN GREY.

Static Sensitive Devices
See Maintenance Section
COMPONENT NUMBER EXAMPLE

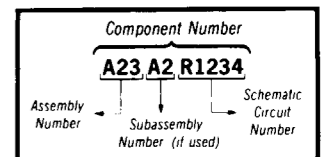

Chassis mounted components have no Assembly Number prefix—see end of Replaceable Electrical Parts List

PARTS LOCATION GRID

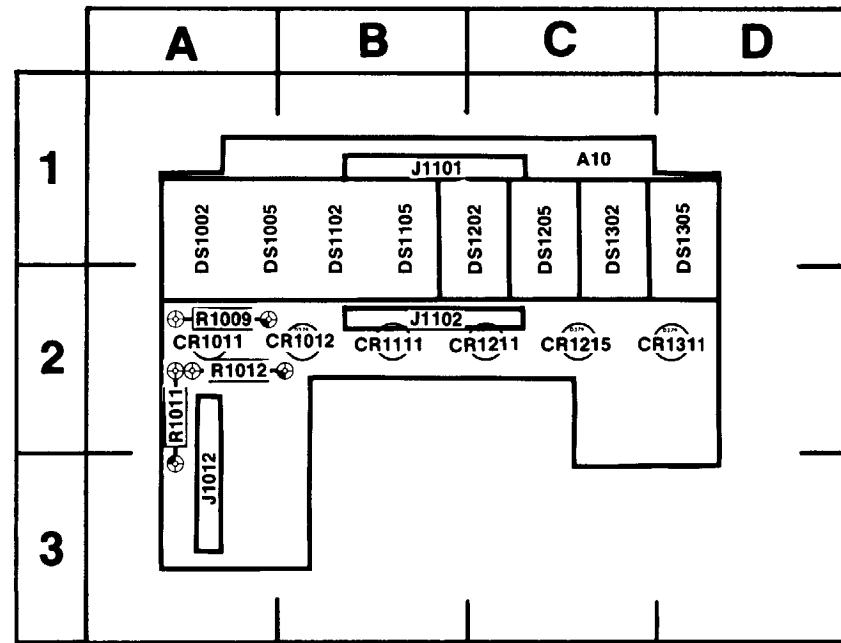

Fig. 8-5. Display Board (A10 Assy).

2971-20

**Table 8-8
COMPONENT REFERENCE CHART**

A10 ASSY			DISPLAY		
Circuit Number	Schematic Location	Board Location	Circuit Number	Schematic Location	Board Location
CR1011	D6	A2	J1012	B7	A3
CR1012	D7	B2	J1101	B5	B1
CR1111	D7	B2	J1102	B2	B2
CR1211	D7	C2	P1012	B7	A3
CR1215	D7	C2	P1101	B5	B1
CR1311	D8	D2	P1102	B2	B2
DS1002	C4	A1	R1009	E7	A2
DS1005	D4	A1	R1011	E6	A2
DS1102	E4	B1	R1012	E7	A2
DS1105	F4	B1			
DS1202	H4	C1			
DS1205	J4	C1			
DS1302	K4	C1			
DS1305	L4	D1			

Static Sensitive Devices
See Maintenance Section

COMPONENT NUMBER EXAMPLE

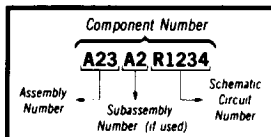

Chassis-mounted components have no Assembly Number prefix—see end of Replaceable Electrical Parts List

A | B | C | D | E | F | H | J | K | L | M

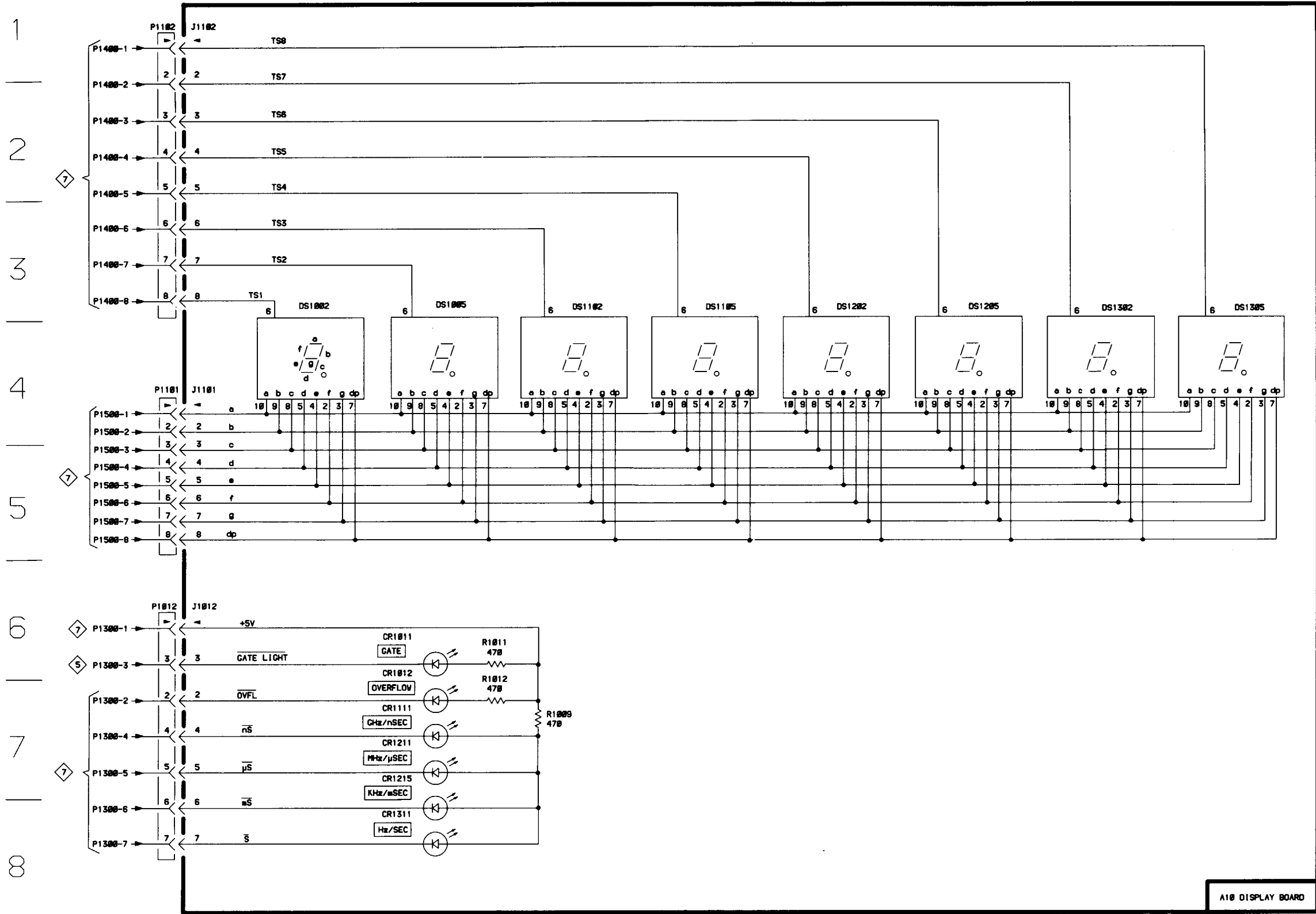

DC 503A

A10 DISPLAY BOARD

DISPLAY

8



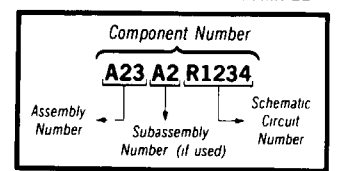









Static Sensitive Devices
See Maintenance Section
COMPONENT NUMBER EXAMPLE



Chassis-mounted components have no Assembly Number prefix—see end of Replaceable Electrical Parts List.

∞

Table 8-9
COMPONENT REFERENCE CHART (See Fig. 8-3)

P/O A12 ASSY			SWITCHING LOGIC 		
Circuit Number	Schematic Location	Board Location	Circuit Number	Schematic Location	Board Location
C1231	C2	E5	R1610E	H5	J3
C1232	B3	E5	R1610F	H5	J3
C1330	B2	E6	R1710A-I	H4	K2
CR1021	F5	B4	S1810	C4	L3
CR1210	C2	E2	U1600C	H2	I2
CR1430	L5	G5	U1600D	F2	I2
J1020	F5	B4	U1600E	F3	I2
P1020	F5	B4	U1600F	L4	I2
P1430	M2	G6	U1601A	F3	J2
P1430	M5	G6	U1601B	E2	J2
R1610A	K4	J3	U1601C	E2	J2
R1610B	C3	J3	U1611A	H2	J3
R1610C	C3	J3	U1611B	K3	J3
R1610D	L4	J3	U1611C	H3	J3
			U1611D	J3	J3
P/O A12 ASSY also shown on     					
P/O A14 ASSY (See Fig. 8-4)					
J1601	M6	C2	R1213A-H	H8	D3
R1100	K7	C2	R1213I	J7	D3
R1110	L7	C3	S1010	D8	A3
R1210	E7	D2			
R1212	D7	D3			
P/O A14 ASSY also shown on      					

A | B | C | D | E | F | H | J | K | L | M

1
2
3
4
5
6
7
8

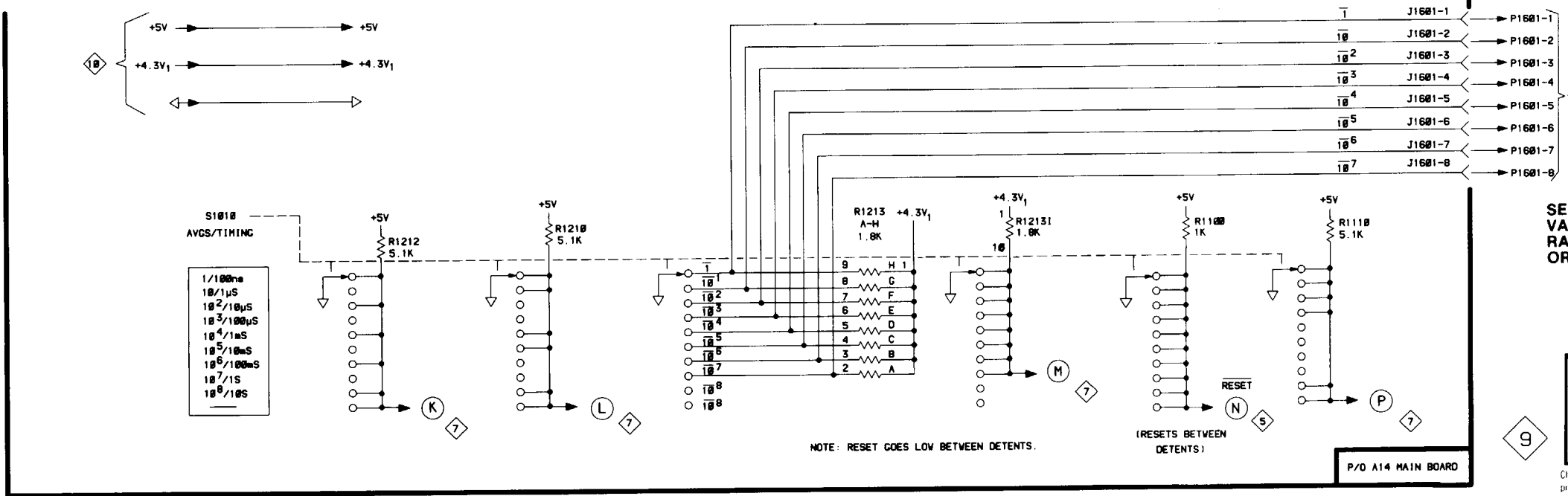
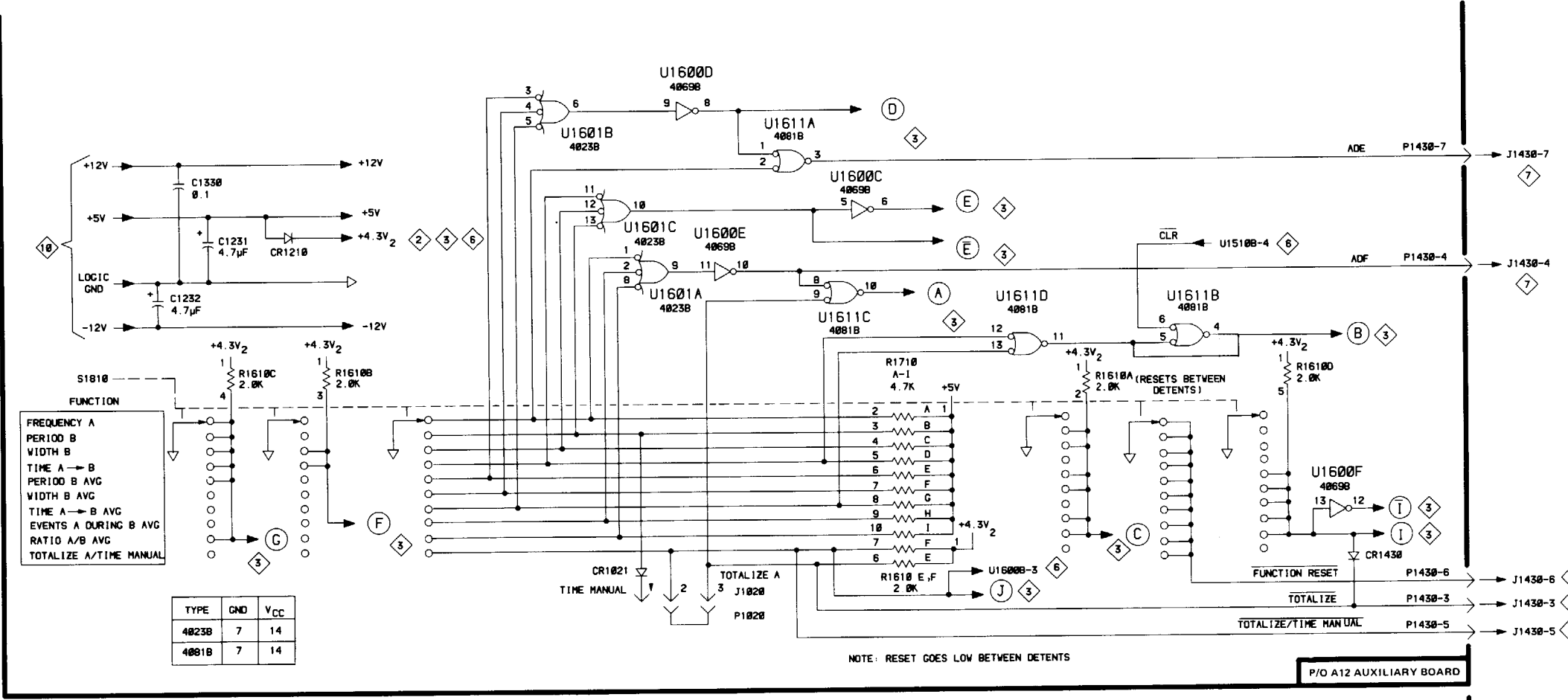

SEE PARTS LIST FOR EARLIER VALUES AND SERIAL NUMBER RANGES OF PARTS OUTLINED OR DEPICTED IN GREY.



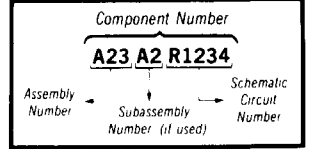









Static Sensitive Devices See Maintenance Section
COMPONENT NUMBER EXAMPLE



Chassis-mounted components have no Assembly Number prefix—see end of Replaceable Electrical Parts List

DC 503A

Table 8-10
COMPONENT REFERENCE CHART (See Fig. 8-4)

P/O A14 ASSY			TIME BASE & POWER SUPPLIES 		
Circuit Number	Schematic Location	Board Location	Circuit Number	Schematic Location	Board Location
C1232	H3	D6	P1900	B5	M3
C1330	K3	F6	P1900	D1	M3
C1331	E3	F5	Q1701	E7	J2
C1332	L3	F6	Q1720	K6	J3
C1410	K2	G3	Q1721	H5	J4
C1420	K2	G4	Q1722	F5	J4
C1600	F3	I1	Q1723	F4	J4
C1610	J2	I3	Q1724	E4	J5
C1700	C9	J1	Q1725	L6	J4
C1702	D9	K1	R1614	K6	J3
C1710	E7	K2	R1620	H5	J5
C1711	E7	K3	R1701	E6	J2
C1712	D7	K3	R1702	E6	J2
C1713	D6	J3	R1710	E7	K2
C1714	J6	J3	R1711	D7	K3
C1715	D7	K3	R1712	D6	J3
C1730	K4	J5	R1713	J5	J3
C1731	C5	K6	R1714	K5	J3
C1732	E5	K6	R1719	J6	J4
C1733	E2	J6	R1720	K6	J4
C1820	F5	K4	R1721	H5	J5
C1830	C4	K6	R1723	F4	J5
CR1110	L2	C3	R1724	L6	J4
CR1721	F4	J5	R1725	L6	J4
CR1730	K4	J5	R1730	H4	J5
CR1731	D4	K5	R1731	L5	J5
CR1732	E5	K5	R1732	L4	J5
CR1733	E2	J6	R1733	D2	K6
F1820	B5	L4	R1734	C3	K6
F1821	B5	L4	R1735	L4	J6
F1830	C1	L5	R1736	D5	K5
J1630	M4	I6	R1801	D9	K1
J1630	H7	I6	R1803	K9	K1
J1710	F7	J3	R1820	F5	K4
J1720	K5	J4	R1821	H4	K4
L1230	F3	D6	R1822	H4	L4
L1330	L3	F5	R1823	H4	L4
L1600	F2	J1	R1824	F4	K5
P1630	H7	I6	R1825	E4	K5
P1710	F7	J3	R1826	D4	L5
P1720	K5	J4	R1827	B4	L5
P1900	M6	M3	R1828	C2	L5
P1900	B8	M3	U1621E	L4	I5
P1900	J4	M3	U1800	D8	L1
P1900	B1	M3	U1830	D4	L6
P1900	M4	M3	U1831	E3	L6
			Y1710	E9	K2
			Y1810	C7	K3
P/O A14 ASSY also shown on      					
P/O A12 ASSY (See Fig. 8-3)					
C1030	L8	B5	Q1030	L8	A5
C1035	K7	B6	Q1032	K8	A5
C1130	K8	B5	R1024	K8	B5
C1230	K9	E5	R1031	L9	B5
P1630	H7	E6	R1032	J7	A6
Q1020	K9	B5	R1033	K8	A6
			R1035	K7	B6
P/O A12 ASSY also shown on     					

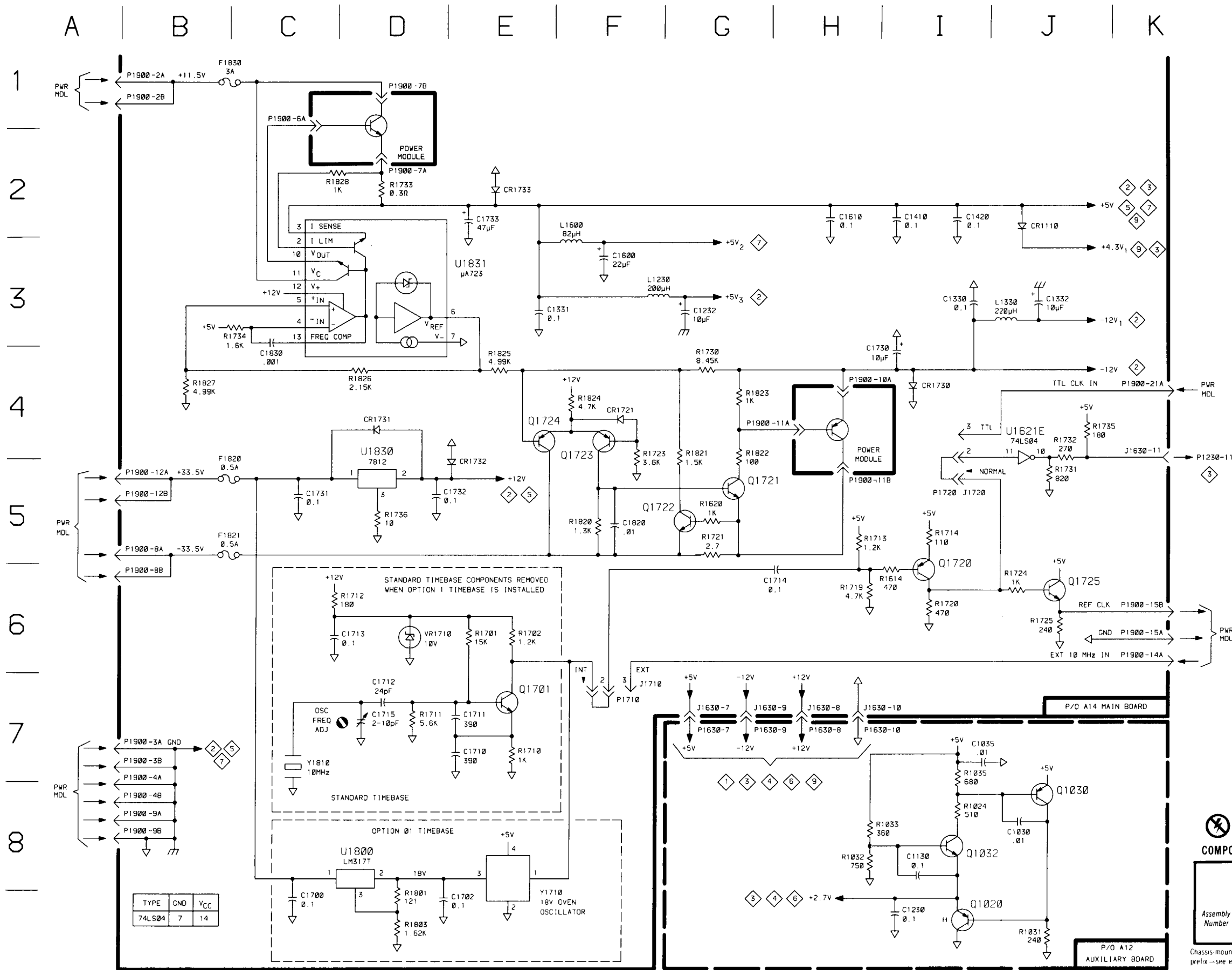

DC 503A

REV A JAN 1981
2971-30

TIME BASE & POWER SUPPLIES

Static Sensitive Devices
See Maintenance Section
COMPONENT NUMBER EXAMPLE

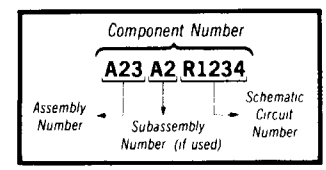

Chassis-mounted components have no Assembly Number prefix—see end of Replaceable Electrical Parts List

JP/00

SECTION 9

REPLACEABLE MECHANICAL PARTS

PARTS ORDERING INFORMATION

Replacement parts are available from or through your local Tektronix, Inc. Field Office or representative.

Changes to Tektronix instruments are sometimes made to accommodate improved components as they become available, and to give you the benefit of the latest circuit improvements developed in our engineering department. It is therefore important, when ordering parts, to include the following information in your order: Part number, instrument type or number, serial number, and modification number if applicable.

If a part you have ordered has been replaced with a new or improved part, your local Tektronix, Inc Field Office or representative will contact you concerning any change in part number.

Change information, if any, is located at the rear of this manual.

SPECIAL NOTES AND SYMBOLS

- X000 Part first added at this serial number
- 00X Part removed after this serial number

FIGURE AND INDEX NUMBERS

INDENTATION SYSTEM

This mechanical parts list is indented to indicate item relationships. Following is an example of the indentation system used in the description column.

- 1 2 3 4 5 *Name & Description*
- Assembly and/or Component*
- Attaching parts for Assembly and/or Component*
-
- Detail Part of Assembly and/or Component*
- Attaching parts for Detail Part*
-
- Parts of Detail Part*
- Attaching parts for Parts of Detail Part*
-

Attaching Parts always appear in the same indentation as the item it mounts, while the detail parts are indented to the right. Indented Items are part of, and included with, the next higher indentation. The separation symbol --- ' --- indicates the end of attaching parts.

Attaching parts must be purchased separately, unless otherwise specified.

ITEM NAME

In the Parts List, an Item Name is separated from the description by a colon (:). Because of space limitations, an Item Name may sometimes appear as incomplete. For further Item Name identification, the U.S. Federal Cataloging Handbook H6-1 can be utilized where possible.

ABBREVIATIONS

#	INCH NUMBER SIZE	ELCTRN	ELECTRON	IN	INCH	SE	SINGLE END
ACTR	ACTUATOR	ELEC	ELECTRICAL	INCAND	INCANDESCENT	SECT	SECTION
ADPTR	ADAPTER	ELCTLT	ELECTROLYTIC	INSUL	INSULATOR	SEMICON	SEMICONDUCTOR
ALIGN	ALIGNMENT	ELEM	ELEMENT	INTL	INTERNAL	SHLD	SHIELD
AL	ALUMINUM	EPL	ELECTRICAL PARTS LIST	LPHLDR	LAMPHOLDER	SHLDR	SHOULDERED
ASSEM	ASSEMBLED	EQPT	EQUIPMENT	MACH	MACHINE	SKT	SOCKET
ASSY	ASSEMBLY	EXT	EXTERNAL	MECH	MECHANICAL	SL	SLIDE
ATTEN	ATTENUATOR	FIL	FIL LISTERHEAD	MTG	MOUNTING	SLFLKG	SELF-LOCKING
AWG	AMERICAN WIRE GAGE	FLEX	FLEXIBLE	NIP	NIPPLE	SLVG	SLEEVING
BD	BOARD	FLH	FLAT HEAD	NON WIRE	NOT WIRE WOUND	SPR	SPRING
BRKT	BRACKET	FLTR	FILTER	OB	ORDER BY DESCRIPTION	SQ	SQUARE
BRS	BRASS	FR	FRAME or FRONT	OD	OUTSIDE DIAMETER	SST	STAINLESS STEEL
BRZ	BRONZE	FSTNR	FASTENER	OVH	OVAL HEAD	STL	STEEL
BSHG	BUSHING	FT	FOOT	PH BRZ	PHOSPHOR BRONZE	SW	SWITCH
CAB	CABINET	FXD	FIXED	PL	PLAIN or PLATE	T	TUBE
CAP	CAPACITOR	GSKT	GASKET	PLSTC	PLASTIC	TERM	TERMINAL
CER	CERAMIC	HDL	HANDLE	PN	PART NUMBER	THD	THREAD
CHAS	CHASSIS	HEX	HEXAGON	PNH	PAN HEAD	THK	THICK
CKT	CIRCUIT	HEX HD	HEXAGONAL HEAD	PWR	POWER	TNSN	TENSION
COMP	COMPOSITION	HEX SOC	HEXAGONAL SOCKET	RCPT	RECEPTACLE	TPG	TAPPING
CONN	CONNECTOR	HLCPS	HELICAL COMPRESSION	RES	RESISTOR	TRH	TRUSS HEAD
COV	COVER	HLEXT	HELICAL EXTENSION	RGD	RIGID	V	VOLTAGE
CPLG	COUPLING	HV	HIGH VOLTAGE	RLF	RELIEF	VAR	VARIABLE
CRT	CATHODE RAY TUBE	IC	INTEGRATED CIRCUIT	RTNR	RETAINER	W	WITH
DEG	DEGREE	ID	INSIDE DIAMETER	SCH	SOCKET HEAD	WSHR	WASHER
DWR	DRAWER	IDNT	IDENTIFICATION	SCOPE	OSCILLOSCOPE	XFMR	TRANSFORMER
		IMPLR	IMPELLER	SCR	SCREW	XSTR	TRANSISTOR

CROSS INDEX-MFR. CODE NUMBER TO MANUFACTURER

Mfr. Code	Manufacturer	Address	City, State, Zip
000BB	BERQUIST COMPANY	4350 WEST 78TH	MINNEAPOLIS, MN 55435
00779	AMP, INC.	P O BOX 3608	HARRISBURG, PA 17105
07707	USM CORP., USM FAS TENER DIV.	510 RIVER RD.	SHELTON, CT 06484
22526	BERG ELECTRONICS, INC.	YORK EXPRESSWAY	NEW CUMBERLAND, PA 17070
49671	RCA CORPORATION	30 ROCKEFELLER PLAZA	NEW YORK, NY 10020
71785	TRW, C INCH CONNECTORS	1501 MORSE AVENUE	ELK GROVE VILLAGE, IL 60007
73743	FISCHER SPECIAL MFG. CO.	446 MORGAN ST.	CINCINNATI, OH 45206
73803	TEXAS INSTRUMENTS, INC., METAL SURGICAL MATERIALS DIV.	34 FOREST STREET	ATTLEBORO, MA 02703
75915	LITTELFUSE, INC.	800 E. NORTHWEST HWY	DES PLAINES, IL 60016
79807	WROUGHT WASHER MFG. CO.	2100 S. O BAY ST.	MILWAUKEE, WI 53207
80009	TEKTRONIX, INC.	P O BOX 500	BEAVERTON, OR 97077
83385	CENTRAL SCREW CO.	2530 CRESCENT DR.	BROADVIEW, IL 60153
93907	CAMCAR SCREW AND MFG. CO.	600 18TH AVE.	ROCKFORD, IL 61101

FIG. &

INDEX NO.	TEKTRONIX PART NO.	SERIAL/MODEL NO. EFF DSCONT	QTY	1	2	3	4	5	MFR NAME & DESCRIPTION	CODE	MFR PART NUMBER
1-1	337-1399-11		1						SHIELD,ELEC:RIGHT SIDE	80009	337-1399-11
-2	337-1399-10		1						SHIELD,ELEC:LEFT SIDE	80009	337-1399-10
-3	366-1023-07		1						KNOB:GRAY,0.127 ID,0.392 OD,0.466	80009	366-1023-07
-4	366-0494-05		2						KNOB:GRAY,0.127 IDX 0.5 OD,0.531H	80009	366-0494-05
-5	-*-		2						RESISTOR VAR:(SEE R500,R600 REPL) (ATTACHING PARTS)		
-6	210-0583-00		2						NUT,PLAIN,HEX.:0.25-32 X 0.312 INCH,BRS	73743	2X20317-402
-7	210-0940-00		2						WASHER,FLAT:0.25 ID X 0.375 INCH OD,STL	79807	OBD
-8	-*-		2						CONNECTOR:(SEE J510,J610 REPL)		
-9	210-0255-00		2						TERMINAL,LUG:0.391" ID INT TOOTH	80009	210-0255-00
-10	366-1690-00		1						KNOB,LATCH:SIL GY,0.53 X0.23 X 1.059	80009	366-1690-00
-11	333-2641-00		1						PANEL,FRONT: (ATTACHING PARTS)	80009	333-2641-00
-12	213-0875-00		2						SCR ASSEM WSHR:6-32 X 0.5,TAPTITE	93907	OBD
-13	334-3796-00		1						PLATE,IDENT:	80009	334-3796-00
-14	378-2030-03		1						LENS,LED DSPL:RED	80009	378-2030-03
-15	105-0719-00		1						LATCH,RETAINING:PLUG-IN (ATTACHING PARTS)	80009	105-0719-00
-16	213-0113-00		1						SCR,TPG,THD FOR:2-32 X 0.312 INCH,PNH STL	93907	OBD
-17	105-0718-01		1						BAR,LATCH RLSE:	80009	105-0718-01
-18	-*-		1						CKT BOARD ASSY:DISPLAY(SEE A10 REPL) (ATTACHING PARTS)		
-19	211-0007-00		2						SCREW,MACHINE:4-40 X 0.188 INCH,PNH STL	83385	OBD
-20	-*-		-						CKT BOAR ASSY INCLUDES:		
-21	136-0252-07		1						TERM SET,PIN:(SEE A10J1012,J1101,J1102 REPL)	22526	75060-012
-22	386-4404-01		12						SOCKET,PIN CONN:W/O DIMPLE	80009	386-4404-01
-23	213-0868-00		1						SUBPANEL,FRONT:W/INSERTS (ATTACHING PARTS)		
-24	-*-		2						SCREW,TPG,TF:6-32 X 0.375 L,FILM,STEEL	93907	OBD
-25	-*-		-						SUBPANEL INCLUDES:		
-26	337-2744-00		5						JACK,TIP:GRAY(SEE J520,J530,J540,J620, J630 REPL)		
-27	366-1512-00		1						SHIELD,ELEC:FRONT SUBPANEL,AL	80009	337-2744-00
-28	384-1506-00		10						PUSH BUTTON:GRAY.0.18 SQ X 0.83 INCH LG	80009	366-1512-00
-29	384-1571-00		2						EXTENSION SHAFT:2-764 L X 0.187 OD,NYLON	80009	384-1506-00
-30	376-0029-00		1						EXTENSION SHAFT:4.275 L X 0.123 DIA	80009	384-1571-00
-31	386-4278-00		1						CPLG,SHAFT,RDG:0.128 ID X 0.312 OD X 0.5"L	80009	376-0029-00
-32	213-0868-00		1						SUPPORT,FRAME:REAR,AL (ATTACHING PARTS)	80009	386-4278-00
-33	386-3657-01		2						SCREW,TPG,TF:6-32 X 0.375 L.FILM,STEEL	93907	OBD
-34	-*-		2						SUPPORT,PLUG IN: (ATTACHING PARTS)	93907	OBD
-35	-*-		1						CKT BOARD ASSY:AUXILIARY(SEE A12 REPL) (ATTACHING PARTS)		
-36	211-0008-00		4						SCREW,MACHINE:4-40 X 0.25 INCH,PNH STL	83385	OBD
-37	-*-		-						CKT BOARD ASSY INCLUDES:		
-38	-*-		1						SWITCH,LEVER:(SEE A12S1810 REPL) (ATTACHING PARTS)		
-39	213-0869-00		3						SCREW,TPG,TF:2-28 X 0.25,PLASTITE	93907	OBD
-40	-*-		4						SWITCH MBS:(SEE A12S1720,S1730,S1731, S1732 REPL)		
-41	343-0495-04		1						CLIP,SWITCH:FRONT,7.5 MM,4 UNIT (ATTACHING PARTS)	80009	343-0495-04
-42	210-3033-00		4						EYELET,METALLIC:0.59 OD X 0.156 INCH LONG	07707	SE-25
-43	343-0499-04		1						CLIP,SWITCH:REAR,7.5MM X 4 UNIT (ATTACHING PARTS)	80009	343-0499-04
-44	210-3033-00		4						EYELET,METALLIC:0.59 OD X 0.156 INCH LONG	07707	SE-25

INDEX NO.	TEKTRONIX PART NO.	SERIAL/MODEL NO.		QTY	NAME & DESCRIPTION	MFR CODE	MFR PART NUMBER
		EFF	DSCONT				
1-42	337-2804-00			1	SHIELD,ELEC:CIRCUIT BOARD	80009	337-2804-00
-43				9	TERMINAL,PIN:(SEE A12J1519,J1530,J1630,J1730 EPL)		
-44	131-0993-00			1	BUS,CONDUCTOR:2 WIRE BLACK	00779	530153-2
-45	136-0252-07			10	SOCKET,PIN CONN:W/O DIMPLE	22526	75060-012
-46	136-0514-00			1	SKT,PL-IN ELEC:MICROCIRCUIT,8 DIP	73803	CS9002-8
-47	136-0269-02			6	SKT,PL-IN ELEC:MICROCIRCUIT,14 DIP,LOW CLE	73803	CS9002-14
-48	136-0260-02			19	SKT,PL-IN ELEC:MICROCIRCUIT,16 DIP,LOW CLE	71785	133-51-92-008
-49				1	CONTACT SET,ELEC:(SEE A12J1020 EPL)		
-50				1	TERM SET,PIN:(SEE A12P1430,P1520,P1521,P1601,P1630 EPL)		
-51	337-2743-00			1	SHIELD,ELEC:CONNECTORS,AL (ATTACHING PARTS)	80009	337-2743-00
-52	211-0007-00			2	SCREW,MACHINE:4-40 X 0.188 INCH,PNH STL	83385	OBD
-53				1	CKT BOARD ASSY:MAIN(SEE A14 EPL) (ATTACHING PARTS)		
-54	211-0008-00			4	SCREW,MACHINE:4-40 X 0.25 INCH,PNH STL	83385	OBD
-55	129-0097-00			4	SPACER,POST:0.560L X 0.188,W/4-40 THD	80009	129-0097-00
-56	211-0012-00			1	SCREW,MACHINE:4-40 X 0.375,PNH STL CD PL	83385	OBD
-57	210-0551-00			1	NUT,PLAIN,HEX:4-40 X 0.25 INCH,STL	83385	OBD
	210-1178-00			1	WSHR,SHOULDERED:FOR MTG TO-220 TRANSISTOR (OPTION 1 ONLY)	49671	DF 137A
	342-0355-00			1	INSULATOR,PLATE:TRANSISTOR,SILICONE RUBBER (OPTION 1 ONLY)	000BB	7403-09FR-51
-58				1	CKT BOARD ASSY INCLUDES: SWITCH,LEVER:(SEE A14S1010 EPL) (ATTACHING PARTS)		
-59	213-0869-00			3	SCREW,TPG,TF:2-28 X 0.25,PLASTITE	93907	OBD
-60				4	SWITCH,MBS:(SEE A14S1020,S1021,S1030,S1031 EPL)		
-61	343-0495-04			1	CLIP,SWITCH:FRONT,7.5 MM,4 UNIT (ATTACHING PARTS)	80009	343-0495-04
-62	210-3033-00			4	EYELET,METALLIC:0.59 OD X 0.156 INCH LONG	07707	SE-25
-63	343-0499-04			1	CLIP,SWITCH:REAR,7.5MM X 4 UNIT (ATTACHING PARTS)	80009	343-0499-04
-64	210-3033-00			4	EYELET,METALLIC:0.59 OD X 0.156 INCH LONG	07707	SE-25
-65	136-0499-08			1	CONNECTOR,RCPT,:8 CONTACT	00779	30380949-8
-66	136-0514-00			1	SKT,PL-IN ELEC:MICROCIRCUIT,8 DIP	73803	CS9002-8
-67				1	SWITCH,PUSH:(SEE A14S1310,S1311 EPL)		
-68	361-0900-00			4	SPACER,PB SW:0.2 L,YELLOW	80009	361-0900-00
-69	136-0499-10			1	CONNECTOR,RCPT,:10 CONTACT	00779	4-380949-0
-70				1	RESISTOR VAR:(SEE A14R1410,S1410 EPL)		
-71	136-0499-12			1	CONNECTOR,RCPT,:12 CONTACT	00779	4-380949-2
-72	337-2804-00			1	SHIELD,ELEC:CIRCUIT BOARD	80009	337-2804-00
-73	136-0670-00			1	SKT,PL-IN ELEC:MICROCKT,18 PIN,LOW PROFILE	73803	CS9002-18
-74	136-0623-00			1	SOCKET,PLUG-IN:40 DIP,LOW PROFILE	73803	CS9002-40
-75	136-0260-02			8	SKT,PL-IN ELEC:MICROCIRCUIT,16 DIP,LOW CLE	71785	133-51-92-008
-76	136-0269-02			5	SKT,PL-IN ELEC:MICROCIRCUIT,14 DIP,LOW CLE	73803	CS9002-14
-77	136-0252-07			8	SOCKET,PIN CONN:W/O DIMPLE	22526	75060-012
-78				2	SOCKET,PIN TERM:(SEE A14J1520,J1521 EPL)		
-79				40	TERMINAL,PIN:(SEE A14J1130,J1230,J1300,J1320,J1400,J1500,J1710,J1720,J1820,J1820 EPL)		
-80	344-0326-00			6	CLIP,ELECTRICAL:FUSE,BRASS	75915	102071
-81	131-0993-00			2	BUS,CONDUCTOR:2 WIRE BLACK	00779	530153-2
-82				1	OSCILLATOR:(SEE A14Y1710 EPL) (OPTION 1 ONLY)		
-83	211-0097-00			2	SCREW,MACHINE:4-40 X 0.312 INCH,PNH STL (OPTION 1 ONLY)	83385	OBD
-84	361-0548-00			2	SPACER,RING:0.125 ID X 0.25 OD X 0.110 ID (OPTION 1 ONLY)	80009	361-0548-00
-85	214-1061-00			1	SPRING,GROUND:FLAT	80009	214-1061-00
-86	426-1515-00			1	FR SECT,PLUG-IN:TOP	80009	426-1515-00
-87	426-0724-19			1	FR SECT,PLUG-IN:BOTTOM	80009	426-0724-19

FIG. &
INDEX
NO.

TEKTRONIX PART NO.	SERIAL/MODEL NO.		QTY	1	2	3	4	5	NAME & DESCRIPTION WIRE ASSEMBLIES	MFR CODE	MFR PART NUMBER
	EFF	DSCONT									
175-2984-00			1						CA ASSY,RF:50 OHM COAX.6.0 L (FROM A12J1522 TO J520)	80009	175-2984-00
352-0169-00			1						HLDR.TERM CONN:2 WIRE BLACK	80009	352-0169-00
175-3539-00			1						CA ASSY,RF:50 OHM COAX.6.0 L (FROM A12J1530 TO J540)	80009	175-3539-00
352-0169-00			1						HLDR.TERM CONN:2 WIRE BLACK	80009	352-0169-00
175-2980-00			1						CA ASSY,SP,ELEC:3,26 AWG,3.0 L (FROM A12J1630 TO R600)	80009	175-2980-00
352-0161-02			2						CONN BODY,PL,EL:3 WIRE RED	80009	352-0161-02
175-2985-00			1						CA ASSY,RF:50 OHM COAX,10.0 L (FROM A14J1130 TO A14J1810)	80009	175-2985-00
352-0169-00			2						HLDR.TERM CONN:2 WIRE BLACK	80009	352-0169-00
175-2980-00			1						CA ASSY,SP,ELEC:3,26 AWG,3.0 L (FROM A14J1230 TO R500)	80009	175-2980-00
352-0161-02			2						CONN BODY,PL,EL:3 WIRE RED	80009	352-0161-02
175-2981-00			1						CA ASSY,SP,ELEC:7,26 AWG,7.0 L (FROM A14J1300 TO A10J1012)	80009	175-2981-00
352-0165-03			2						CONN BODY,PL,EL:7 WIRE ORANGE	80009	352-0165-03
175-3056-00			1						CA ASSY,SP,ELEC:2-26 AWG,5.5 L (FROM A14J1320 TO J620,J630)	80009	175-3056-00
352-0169-01			1						HLDR TERM CONN:2 WIRE,BROWN	80009	352-0169-01
175-2983-00			1						CA ASSY,SP,ELEC:8,26 AWG,6.0 L (FROM A14J1400 TO A10J1102)	80009	175-2983-00
352-0166-04			2						CONN BODY,PL,EL:8 WIRE YELLOW	80009	352-0166-04
175-2982-00			1						CA ASSY,SP,ELEC:8,26 AWG,8.0 L (FROM A14J1500 TO A10J1101)	80009	175-2982-00
352-0166-05			2						CONN BODY,PL,EL:8 WIRE GREEN	80009	352-0166-05
175-2986-00			1						CA ASSY,RF:50 OHM COAX,14.5 L (FROM A14J1820 TO A12J1730)	80009	175-2986-00
352-0169-00			2						HLDR,TERM CONN:2 WIRE BLACK	80009	352-0169-00

APPENDIX A

REFERENCES

DA PAM 310-4	Index of Technical Manuals, Technical Bulletins, Supply Manuals (Types 7, 8, and 9), Supply Bulletins, and Lubrication orders
DA PAM 310-7	Index of US Army Equipment Modification Work Orders
FM 21-11	First Aid for Soldiers
AR 385-40	Accident Reporting and Records
AR 750-1	Army Materiel Maintenance Concept and Policies
TB 750-25-1	Maintenance Supplies and Equipment: Army Metrology and Calibration System
TM 38-750	The Army Maintenance Management System (TAMMS)
TM 750-244-2	Procedures for Destruction of Electronics Materiel to Prevent Enemy Use

APPENDIX B

MAINTENANCE ALLOCATION CHART

Section 1. INTRODUCTION

B-1. GENERAL.

a. This section provides a general explanation of all maintenance and repair functions authorized at various maintenance categories.

b. The Maintenance Allocation Chart (MAC) in Section II designates overall authority and responsibility for the performance of maintenance functions on the identified end items or component. The application of the maintenance functions to the end item or component will be consistent with the capacities and capabilities of the designated maintenance categories.

c. Section III lists the tools and test equipment (both special and common) required for each maintenance function as referenced from Section II.

d. Section IV contains supplemental instructions and explanatory notes for a particular maintenance function.

B-2. MAINTENANCE FUNCTIONS. Maintenance Functions will be limited to and defined as follows:

a. *Inspect.* To determine the serviceability of an item by comparing its physical, mechanical, and/or electrical characteristics with established standards through examination (e.g., by sight, sound, or feel).

b. *Test.* To verify serviceability by measuring the mechanical, pneumatic, hydraulic, electrical characteristics of an item and comparing those characteristics with prescribed standards.

c. *Service.* Operations required periodically to keep an item in proper operating condition, i.e., to clean (includes decontaminate, when required), to preserve, to drain, to paint, or to replenish fuel, lubricants, chemical fluids, or gases.

d. *Adjust.* To maintain or regulate, within prescribed limits, by bringing into proper or exact position, or by setting the operating characteristics to specified parameters.

e. *Aline.* To adjust specified variable elements of an item to bring about optimum or desired performance.

f. *Calibrate.* To determine and cause corrections to be made or to be adjusted on instruments or test, measuring, and diagnostic equipment used in precision measurement. Consists of comparisons of two instruments, one of which is a certified standard of known accuracy, to detect and adjust any discrepancy in the accuracy of the instrument being compared.

g. *Removal/Install.* To remove and install the same item when required to perform service or other maintenance functions. Install may be the act of emplacing, seating, or fixing into position a spare, repair part, or module (component or assembly) in a manner to allow the proper functioning of an equipment or system.

h. *Replace.* To remove an unserviceable item and install a serviceable counterpart in its place.

i. *Repair.* The application of maintenance services 1, including fault location/troubleshooting 2, removal/installation, and disassembly/assembly 3, procedures, and maintenance actions 4, to identify troubles and restore serviceability to an item by correcting specific damage, fault, malfunction, or failure in a part, subassembly, module (component or assembly), end item, or system.

TM 9-6625-474-14&P-3

j. Overhaul. That maintenance effort (service/action) prescribed to restore an item to a completely serviceable-operational condition as required by maintenance standard in appropriate technical publications. Overhaul is normally the highest degree of maintenance performed by the Army. Overhaul does not normally return an item to like-new condition.

k. Rebuild. Consists of those services/actions necessary for the restoration of unserviceable equipment to a like-new condition in accordance with original manufacturing standards, Rebuild is the highest degree of material maintenance applied to army equipment and is normally reserved for the depot category of maintenance. The rebuild operation includes the act of returning to zero those age measurements (hours/mile, etc.) considered in classifying army equipment/components.

(1) Services - inspect, test, service, adjust, align, calibrate, and/or replace.

(2) Fault locate/troubleshoot - the process of investigating and detecting the cause of equipment malfunctioning; the act of isolating a fault within a system or Unit Under Test (UUT).

(3) Disassembly/assembly - encompasses the step-by-step taking apart (or breakdown) of a repairable assembly (group numbered item) to the level of its least component identified as maintenance significant (i. e., assigned an SMR code) for the category of maintenance under consideration.

(4) Actions - welding, grinding, riveting, straightening, facing, remachinery, and/or resurfacing.

B-3. EXPLANATION OF COLUMNS IN THE MAC, SECTION II.

a. Column 1, Group Number. Column 1 lists group numbers, the purpose of which is to identify maintenance significant components, assemblies, subassemblies, and modules with the next higher assembly.

b. Column 2, Component/Assembly. Column 2 contains the names of components, assemblies, subassemblies, and modules for which maintenance is authorized.

c. Column 3, Maintenance Function. Column 3 lists the functions to be performed on the item listed in Column 2 (for detailed explanation of these functions, see paragraph B-2).

d. Column 4, Maintenance Category. Column 4 specifies, by the listing of a work time figure in the appropriate subcolumn(s), the category of maintenance authorized to perform the function listed in Column 3. This figure represents the active time required to perform that maintenance function at the indicated category of maintenance. If the number of complexity of the tasks within the listed maintenance function vary at different maintenance categories, appropriate work time figures will be shown for each category. The work time figure represents the average time required to restore an item (assembly, subassembly, component, module, end item, or system) to a serviceable condition under typical field operating conditions, This time includes preparation time (including any necessary disassembly/assembly time), troubleshooting/fault location time, and quality assurance/quality control time in addition to the time required to perform the specific tasks identified for the maintenance functions authorized in the maintenance allocation chart. The symbol designations for the various maintenance categories are as follows:

C.	Operator or Crew
O.	Organizational Maintenance
F	Direct Support Maintenance
H.	General Support Maintenance
L	Specialized Repair Activity (SRA) ₅
D.	Depot Maintenance

5 This maintenance category is not included in Section II, column (4) of the Maintenance Allocation Chart. To identify functions to this category of maintenance, enter a work time figure in the "H" column of Section II, column (4), and use an associated reference code in the Remarks column (6). Key the code to Section IV, Remarks, and explain the SRA complete repair application there. The explanatory remark(s) shall reference the specific Repair Parts and Special Tools List (RPSTL) TM which contains additional SRA criteria and the authorized spare/repair parts.

e. *Column 5, Tools and Test Equipment.* Column 5 specifies, by code, those common tools sets (not individual tools) and special tools, TMDE, and support equipment required to perform the designated function.

f. *Column 6, Remarks.* This column shall, when applicable, contain a letter code, in alphabetic order, which shall be keyed to the remarks contained in Section IV.

B-4. EXPLANATION OF COLUMNS IN TOOL AND TEST EQUIPMENT REQUIREMENTS, SECTION III.

a. *Column 1, Reference Code.* The tool and test equipment reference code correlates with a code used in the MAC, Section III, Column 5.

b. *Column 2, Maintenance Category.* The lowest category of maintenance authorized to use the tool or test equipment.

c. *Column 3, Nomenclature.* Name or identification of the tool or test equipment.

d. *Column 4, National Stock Number.* The National Stock Number of the tool or test equipment.

e. *Column 5, Too/Number.* The manufacturer's part number

B-5. EXPLANATION OF COLUMNS IN REMARKS, SECTION IV.

a. *Column 1, Reference Code.* The code recorded in Column 6, Section II.

b. *Column 2, Remarks.* This column lists information pertinent to the maintenance function being performed as indicated in the MAC, Section II.

**SECTION II. MAINTENANCE ALLOCATION CHART
FOR
TEKTRONIX DC 503A UNIVERSAL COUNTER**

(1)	(2)	(3)	(4)					(5)	(6)
GROUP NUMBER	COMPONENT/ASSEMBLY	MAINTENANCE FUNCTION	MAINTENANCE CATEGORY*					TOOLS AND EQUIPT	REMARKS
			C	O	F	H	D		
Fig 1	TEK 503A Universal Counter	Insp	.10						A
		Test							
	Circuit Card Assy	Repair						2	C D
		Insp				.10			
	Circuit Card Assy	Replace				.50		2	B
		Insp				.10			
	Push Button	Replace				.50		2	B
		Insp				.10			
		Replace				.50	2	B	

*C.operator/crew O.organizational F.direct support H.general support D.depot

**SECTION III. TOOL AND TEST EQUIPMENT REQUIREMENTS
FOR
TEKTRONIX DC 503A UNIVERSAL COUNTER**

TOOL OR TEST EQUIPMENT	MAINTENANCE CATEGORY	NOMENCLATURE	NATIONAL/NATO STOCK NUMBER	TOOL NUMBER
1	H	Test Equipment		Ref Table 4-1
2	H	JTK 17LAL, 35H Tool Kit	4931-01-073-3845	

SECTION IV. REMARKS

REFERENCE CODE	REMARKS
A	Organizational maintenance will be accomplished by the organization owning and using the equipment.
B	All special tools and test equipment are called out in Table 4-1.
C	Supply of parts will be through normal supply channels.
D	A recommended repair parts list will be published as part of this manual. Parts that have NSN'S assigned will be requisitioned separately and will not be part of this kit..

APPENDIX C
 RECOMMENDED SPARE PARTS LIST
 FOR
 TEKTRONIX DC 503A UNIVERSAL COUNTER

ITEM NO.	TEKTRONIX PART NO.	ITEM NAME	REC. QTY
1	136-0387-00	JACK, TIP	1
2	366-1512-00	PUSH BUTTON	1
3	670-6556-01	CIRCUIT BD ASSY	1
4	672-0103-00	CIRCUIT BD ASSY	1

APPENDIX D

MANUAL CHANGE INFORMATION

DESCRIPTION

EFF SN B021384 (STANDARD)
 EFF SN B021530 (OPTION 01)

REPLACEABLE ELECTRICAL PARTS AND SCHEMATIC CHANGES

CHANGE TO:

A12 670-6557-01 CKT BOARD ASSY:AUXILIARY

ADD:

A12CR1320 152-0075-00 SEMICOND DEVICE:SW,GE,22V,40MA

DIAGRAM 3 SIGNAL ROUTING TIME A-B GENERATOR & GATE GENERATOR - Partial

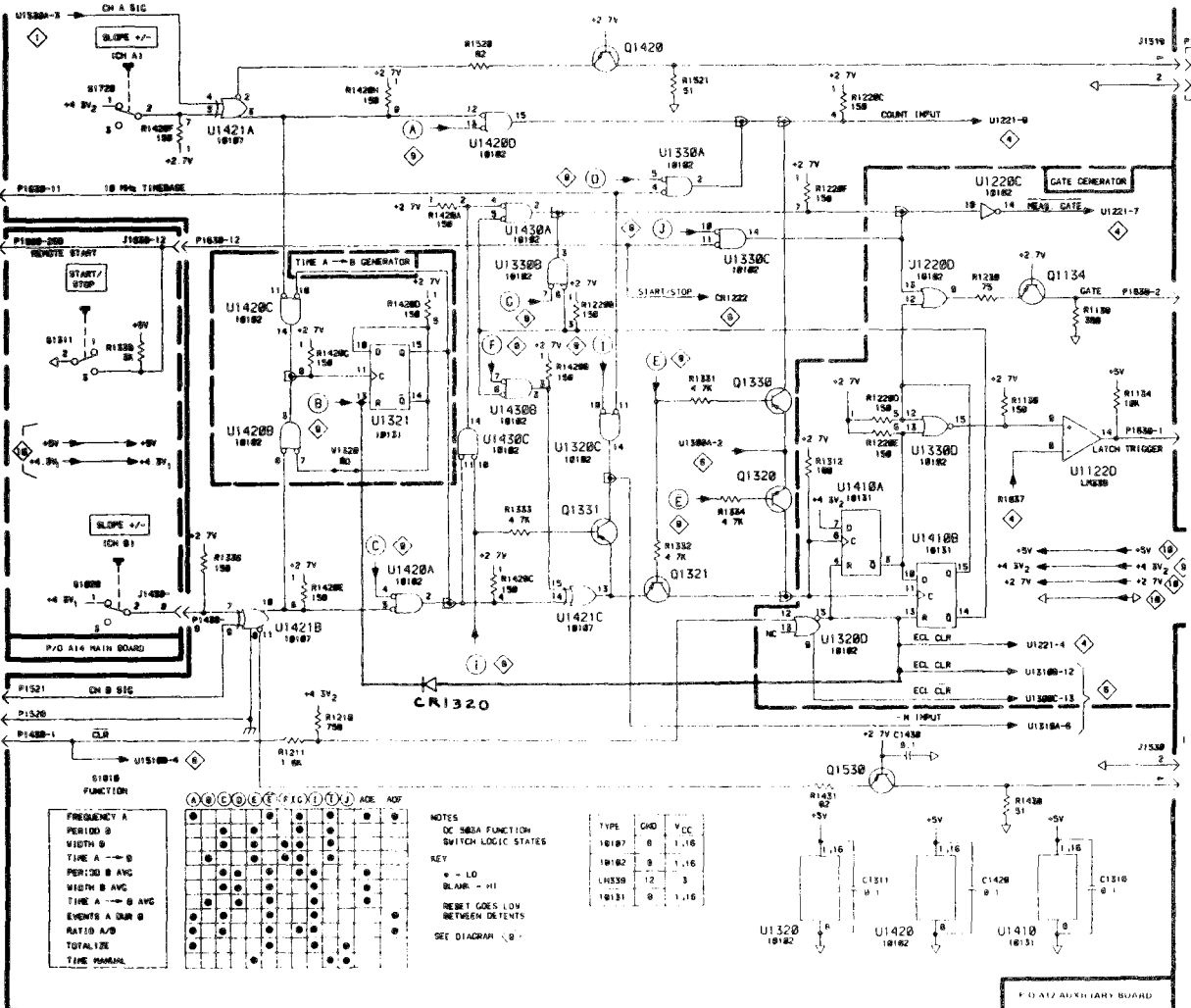

DC 503A

F 01 A12 AUXILIARY BOARD

DESCRIPTION

EFF SN B021520 (DC503A)

EFF SN B021540 (DC503A-01)

ELECTRICAL PARTS AND SCHEMATIC CHANGES

CHANGE TO:

A12 670-6557-02 CKT BOARD ASSY:AUXILIARY

REMOVE:

A12CR1320 152-0075-00 SEMICOND DEVICE: SW,SI,22V,40MA

ADD:

A12W1322 131-0566-00 BUS CONDUCTOR:DUMMY RES,2.375,22 AWG

DIAGRAM 3 SIGNAL ROUTING, TIME A-B GENERATOR & GATE GENERATOR - Partial

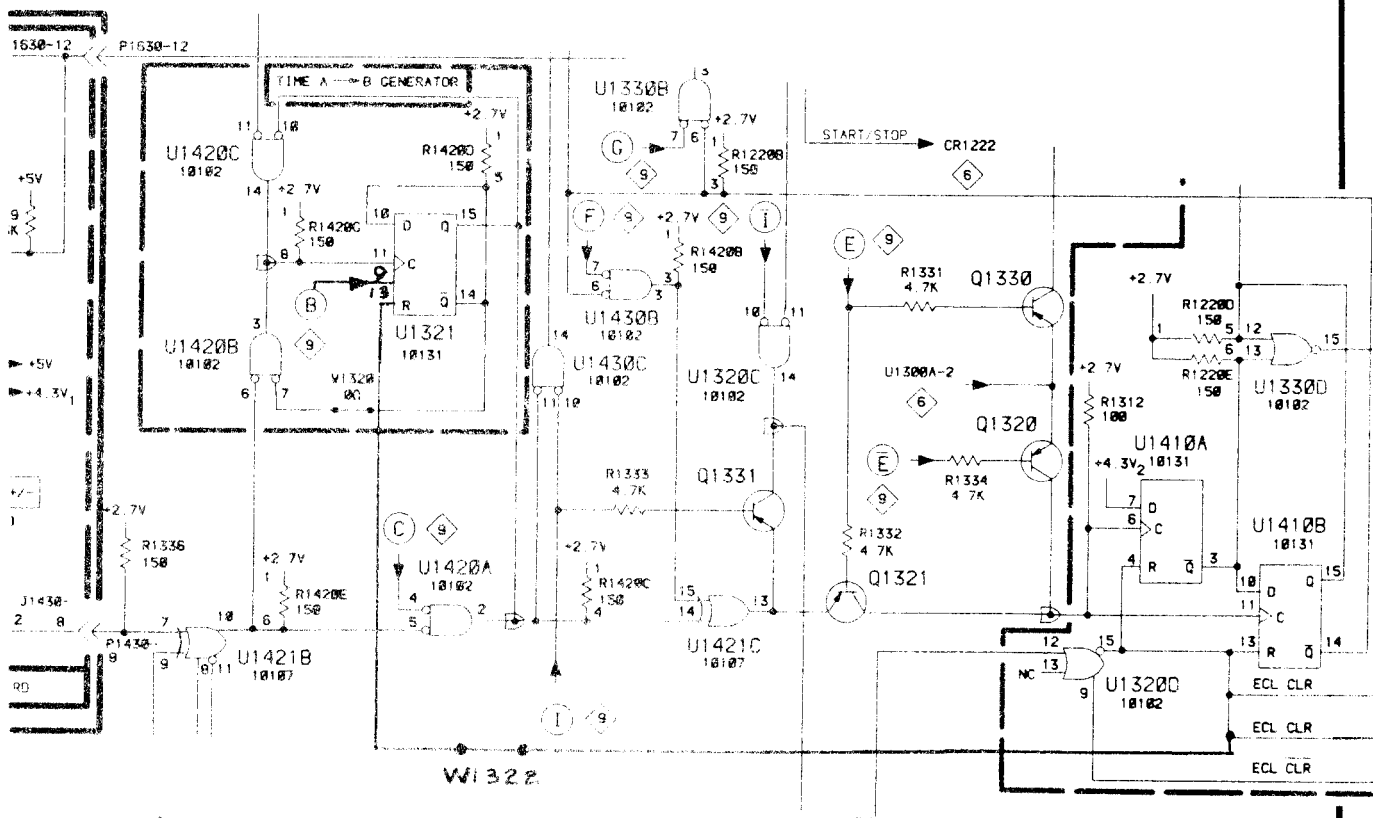
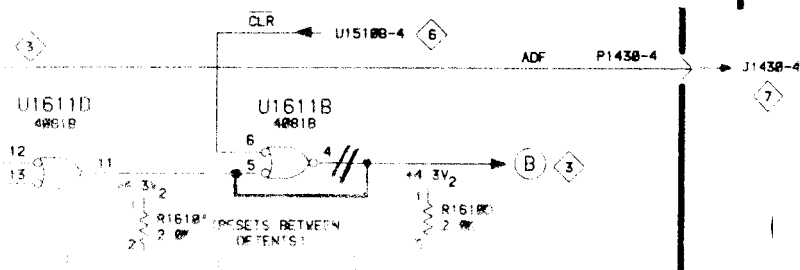

DIAGRAM 9 SWITCHING LOGIC - Partial



DESCRIPTION

EFF SN B022170 (STANDARD)

EFF SN B022250 (OPTION 01)

REPLACEABLE ELECTRICAL PARTS AND SCHEMATIC CHANGES

CHANGE TO:

A12 670-6557-03 CKT BOARD ASSY:AUXILIARY

ADD:

A13 670-7508-00 CKT BOARD ASSY:HEX CMOS BUFFER

CHANGE TO:

A12U1500 156-0472-00 MICROCIRCUIT,DI:13 INP NAND GATE,74S133

REMOVE:

A12U1600 156-0745-00 MICROCIRCUIT,DI:HEX INVERTER

The new 670-7508-00 circuit board consists of:

A13U1600 156-0494-02 MICROCIRCUIT,DI:HEX INV/BUFF,SEL,4049

131-0787-00 14 TERMINAL,PIN:0.64 L X 0.025 SQ PH BRZ GO LD PL

(U1600 is removed from A12 and added to new piggyback board A13 HEX CMOS BUFFER, which is installed in the old U1600 socket.)

DIAGRAM 6 ÷N CIRCUIT - Partial

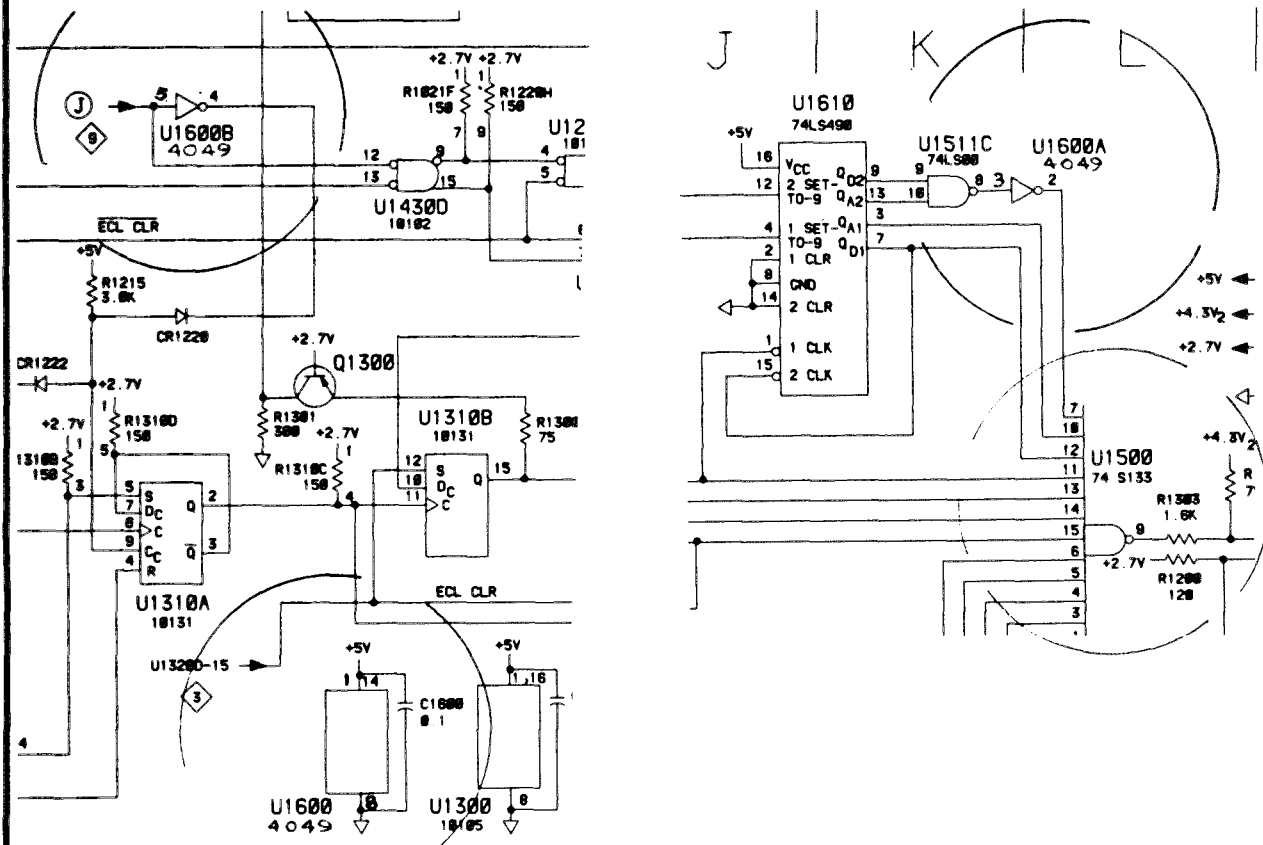

SCHMATIC CHANGES

DIAGRAM 9 SWITCHING LOGIC - Partial

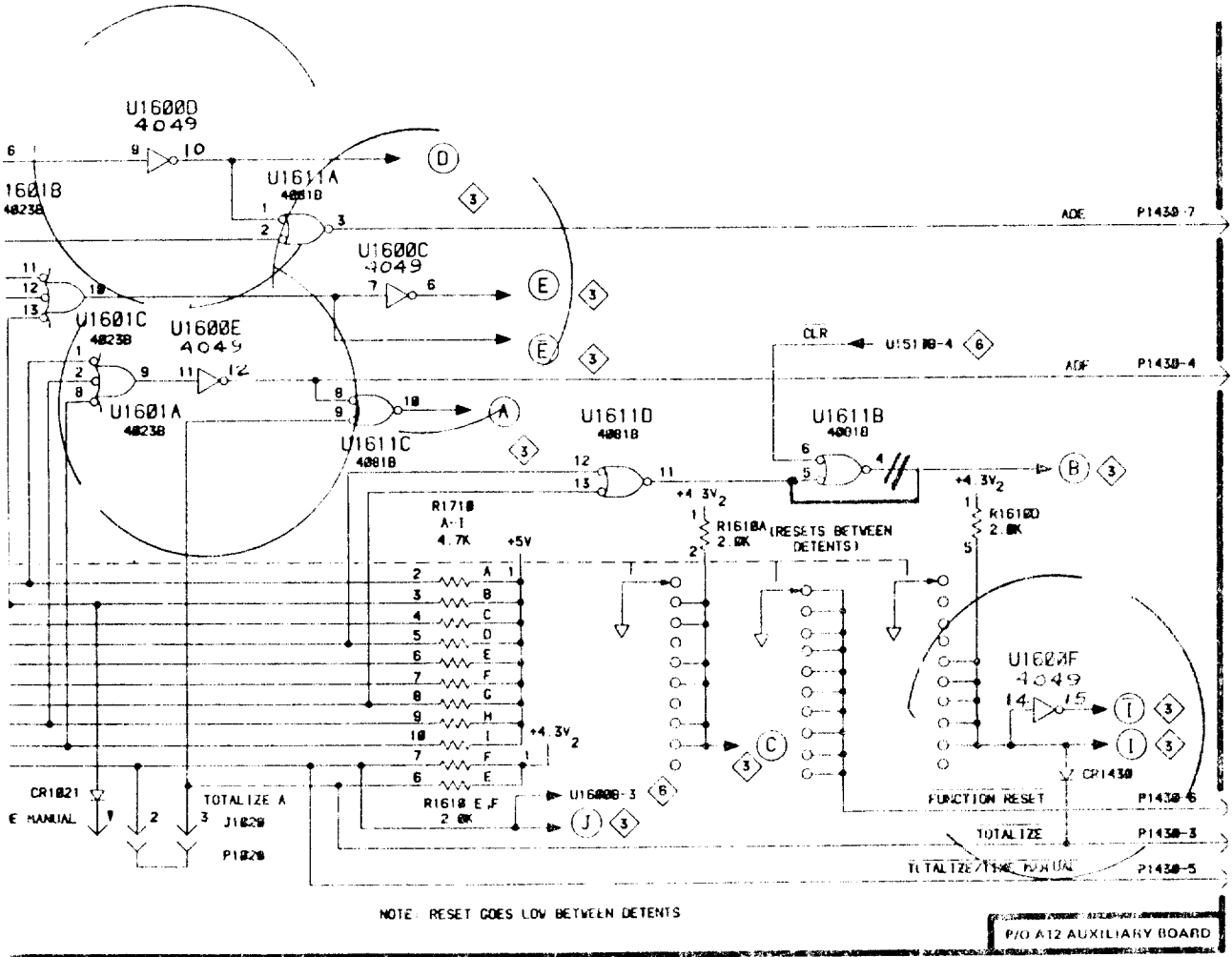

DESCRIPTION

EFF SN B022560 (DC 503A)

EFF SN B022710 (DC 503A -Option 01)

REPLACABLE ELECTRICAL PARTS AND SCHEMATIC CHANGES

CHANGE TO:

A14	670-6556-01	CKT BOARD ASSY:MAIN
A14	670-6559-01	CKT BOARD ASSY:MAIN
		(OPTION 1 ONLY)
A14C1431	281-0852-00	CAP., FXD, CER DI : 1800 PF, 10%, 100V
A14R1531	315-0512-00	RES., FXD, CMPSN : 5.1K OHM, 5%, 0.25W
A14U1423	156-1152-00	MICROCIRCUIT, DI : DUAL PRCN RETRIGGERABLE, RESETTABLE MONOSTABLE MULTIVIBRATOR

The above components are shown on diagram 5 MEASUREMENT CYCLE TIMING and are located on the MAIN circuit board assembly.

DESCRIPTION

EFF SN B022960 (Standard)

EFF SN B022920 (Option 1)

REPLACEABLE ELECTRICAL PARTS LIST AND SCHEMATIC CHANGES

CHANGE TO:

A12	670-6557-04	CKT BOARD ASSY:AUXILIARY
A14	670-6558-02	CKT BOARD ASSY:MAIN
A14	670-6559-02	CKT BOARD ASSY:MAIN
		(OPTION 1 ONLY)
A12C1522	281-0763-00	CAP., FXD, CER DI:47PF,10%,100V
A12R1530	315-0820-00	RES., FXD, CMPSN:82 OHM,5%,0.25W
A14C1322	281-0763-00	CAP., FXD, CER DI:47PF,10%,100V
A14R1326	315-0820-00	RES., FXD, CMPSN:82 OHM,5%,0.25W
A14R1500	315-0680-00	RES., FXD, CMPSN:68 OHM,5%,0.25W
A14R1501	315-0680-00	RES., FXD, CMPSN:68 OHM,5%,0.25W
A14R1502	315-0680-00	RES., FXD, CMPSN:68 OHM,5%,0.25W
A14R1503	315-0680-00	RES., FXD, CMPSN:68 OHM,5%,0.25W
A14R1504	315-0680-00	RES., FXD, CMPSN:68 OHM,5%,0.25W
A14R1505	315-0680-00	RES., FXD, CMPSN:68 OHM,5%,0.25W
A14R1506	315-0680-00	RES., FXD, CMPSN:68 OHM,5%,0.25W

ADD:

A14C1703	283-0081-00	CAP., FXD, CER DI:0.1UF,+80-20%,25V
		(OPTION 1 ONLY)

DIAGRAM 10 TIME BASE & POWER SUPPLIES - Partial

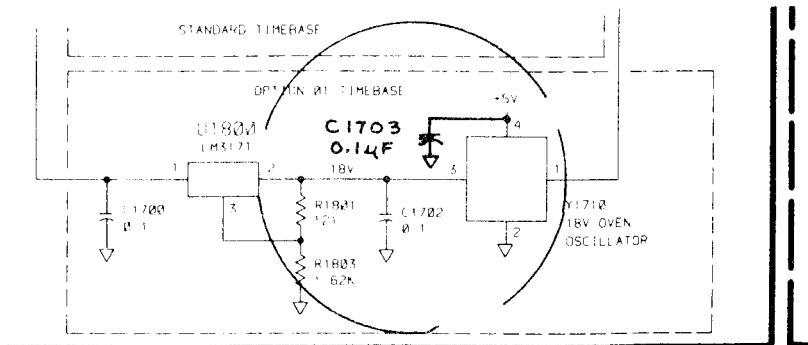

By Order of the Secretary of the Army:

JOHN A. WICKHAM, JR.
General, United States Army
Chief of Staff

Official:

ROBERT M. JOYCE
Major General, United States Army
The Adjutant General

Distribution:

To be distributed in accordance with DA Form 12-37, Block 1097, Organizational Maintenance requirements for Bradley Fighting Vehicle TOW Subsystem.

SOMETHING WRONG

WITH THIS PUBLICATION?



THEN... JOT DOWN THE DOPE ABOUT IT ON THIS FORM. CAREFULLY CUT IT OUT. FOLD IT AND DROP IT IN THE MAIL!

FROM: (PRINT YOUR UNIT'S COMPLETE ADDRESS)

DATE SENT

PUBLICATION NUMBER

PUBLICATION DATE

PUBLICATION TITLE

BE EXACT... PIN-POINT WHERE IT IS

PAGE NO.	PARA-GRAPH	FIGURE NO.	TABLE NO.
----------	------------	------------	-----------

IN THIS SPACE TELL WHAT IS WRONG AND WHAT SHOULD BE DONE ABOUT IT:

CUT ALONG THIS LINE

PRINTED NAME, GRADE OR TITLE, AND TELEPHONE NUMBER

SIGN HERE

THE METRIC SYSTEM AND EQUIVALENTS

WEIGHT MEASURE

1 Centimeter = 10 Millimeters = 0.01 Meters = 0.3937 Inches
 1 Meter = 100 Centimeters = 1000 Millimeters = 39.37 Inches
 1 Kilometer = 1000 Meters = 0.621 Miles

WEIGHTS

1 Gram = 0.001 Kilograms = 1000 Milligrams = 0.035 Ounces
 1 Kilogram = 1000 Grams = 2.2 lb.
 1 Metric Ton = 1000 Kilograms = 1 Megagram = 1.1 Short Tons

LIQUID MEASURE

1 Milliliter = 0.001 Liters = 0.0338 Fluid Ounces
 1 Liter = 1000 Milliliters = 33.82 Fluid Ounces

SQUARE MEASURE

1 Sq. Centimeter = 100 Sq. Millimeters = 0.155 Sq. Inches
 1 Sq. Meter = 10,000 Sq. Centimeters = 10.76 Sq. Feet
 1 Sq. Kilometer = 1,000,000 Sq. Meters = 0.386 Sq. Miles

CUBIC MEASURE

1 Cu. Centimeter = 1000 Cu. Millimeters = 0.06 Cu. Inches
 1 Cu. Meter = 1,000,000 Cu. Centimeters = 35.31 Cu. Feet

TEMPERATURE

$5/9(^{\circ}\text{F} - 32) = ^{\circ}\text{C}$
 212° Fahrenheit is equivalent to 100° Celsius
 90° Fahrenheit is equivalent to 32.2° Celsius
 32° Fahrenheit is equivalent to 0° Celsius
 $9/5^{\circ}\text{C} + 32 = ^{\circ}\text{F}$

APPROXIMATE CONVERSION FACTORS

TO CHANGE	TO	MULTIPLY BY
Inches	Centimeters	2.540
Feet	Meters	0.305
Yards	Meters	0.914
Miles	Kilometers	1.609
Square Inches	Square Centimeters	6.451
Square Feet	Square Meters	0.093
Square Yards	Square Meters	0.836
Square Miles	Square Kilometers	2.590
Acres	Square Hectometers	0.405
Cubic Feet	Cubic Meters	0.028
Cubic Yards	Cubic Meters	0.765
Fluid Ounces	Milliliters	29.573
its	Liters	0.473
arts	Liters	0.946
allons	Liters	3.785
Ounces	Grams	28.349
Pounds	Kilograms	0.454
Short Tons	Metric Tons	0.907
Pound-Feet	Newton-Meters	1.356
Pounds per Square Inch	Kilopascals	6.895
Miles per Gallon	Kilometers per Liter	0.425
Miles per Hour	Kilometers per Hour	1.609

TO CHANGE	TO	MULTIPLY BY
Centimeters	Inches	0.394
Meters	Feet	3.280
Meters	Yards	1.094
Kilometers	Miles	0.621
Square Centimeters	Square Inches	0.155
Square Meters	Square Feet	10.764
Square Meters	Square Yards	1.196
Square Kilometers	Square Miles	0.386
Square Hectometers	Acres	2.471
Cubic Meters	Cubic Feet	35.315
Cubic Meters	Cubic Yards	1.308
Milliliters	Fluid Ounces	0.034
Liters	Pints	2.113
Liters	Quarts	1.057
ers	Gallons	0.264
ms	Ounces	0.035
ograms	Pounds	2.205
Metric Tons	Short Tons	1.102
Newton-Meters	Pounds-Feet	0.738
Kilopascals	Pounds per Square Inch	0.145
ometers per Liter	Miles per Gallon	2.354
ometers per Hour	Miles per Hour	0.621

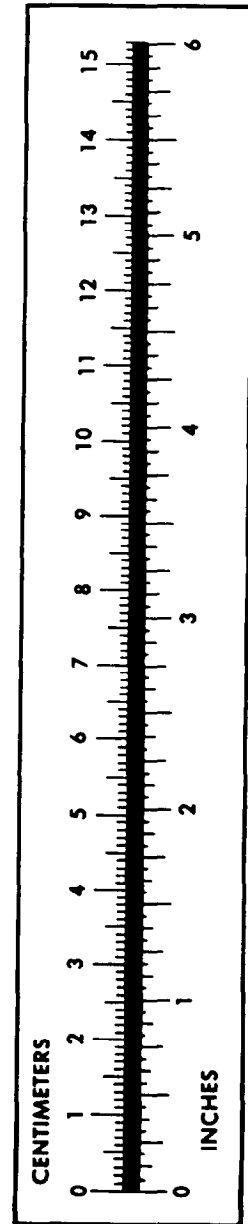

PIN: 056816-000