

TEKTRONIX®

P6065A
PROBE

010-6065-13

INSTRUCTION MANUAL

Tektronix, Inc.
P.O. Box 500
Beaverton, Oregon 97005

Serial Number _____

WARRANTY

All TEKTRONIX instruments are warranted against defective materials and workmanship for one year. Any questions with respect to the warranty should be taken up with your TEKTRONIX Field Engineer or representative.

All requests for repair and replacement parts should be directed to the TEKTRONIX Field Office or representative in your area. This will assure you the fastest possible service. Please include the instrument Type Number or Part Number and Serial Number with all requests for parts or service.

Specifications and price change privileges reserved.

Copyright © 1973 by Tektronix, Inc., Beaverton, Oregon. Printed in the United States of America. All rights reserved. Contents of this publication may not be reproduced in any form without permission of Tektronix, Inc.

U.S.A. and Foreign TEKTRONIX products covered by U.S. and foreign patents and/or patents pending.

TEKTRONIX is a registered trademark of Tektronix, Inc.

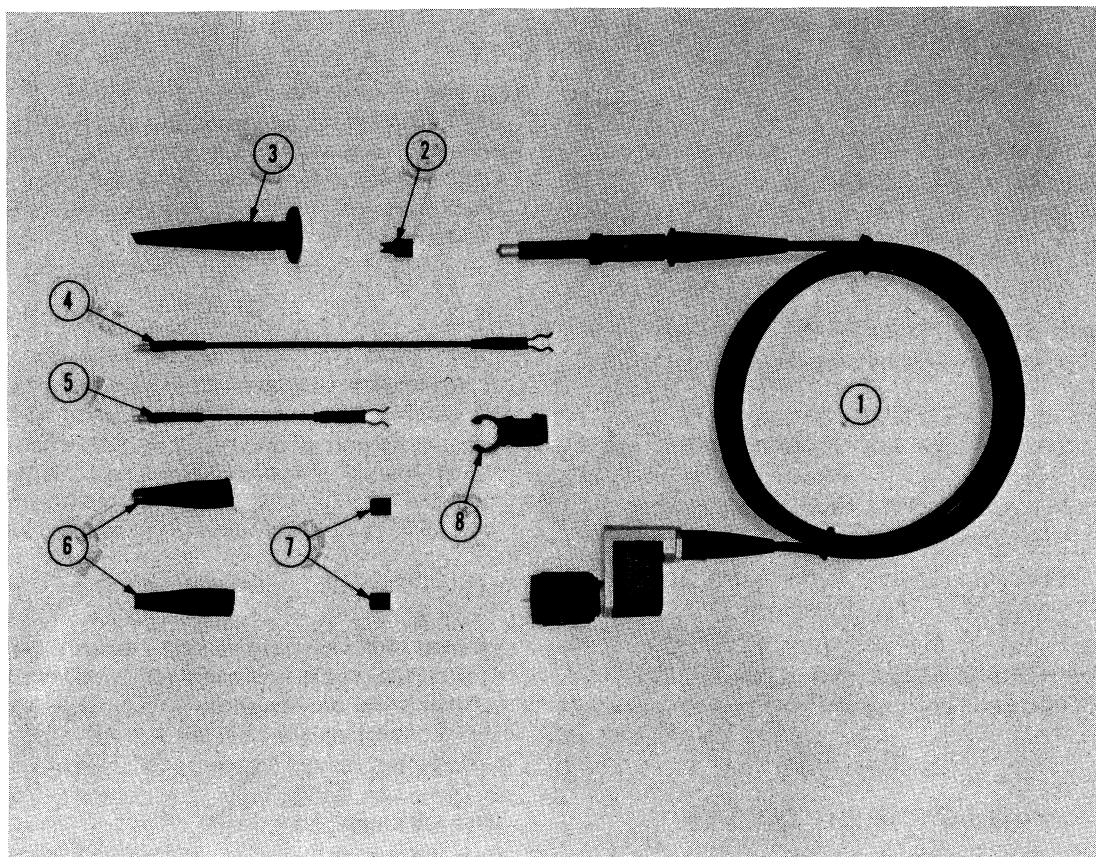

Fig. 1. P6065A Probe and Standard Accessories.

Fig. & Index No.	Tektronix Part No.	Serial/Model No.		Qty	1	2	3	4	5	Name & Description	Mfr Code	Mfr Part Number
		Eff	Dscont									
1-	010-6065-13			1						PROBE PACKAGE:P6065A,6 FOOT	80009	010-6065-13
	010-6065-15			1						PROBE PACKAGE:P6065A,9 FOOT	80009	010-6065-15
	- - - - -			-						PROBE PACKAGE INCLUDES:		
-1	010-6065-12			1						PROBE:P6065A,6 FOOT WITH IC TIP	80009	010-6065-12
	010-6065-14			1						PROBE:P6065A,9 FOOT WITH IC TIP	80009	010-6065-14
-2	015-0201-00			1						TIP,PROBE:IC TEST (INCLUDED WITH PROBE)	80009	015-0201-00
-3	013-0107-03			1						TIP,PROBE:RETRACTABLE HOOK ASSY W/FLANGE	80009	013-0107-03
-4	175-0124-01			1						LEAD,ELECTRICAL:GROUND,5 INCHES LONG	80009	175-0124-01
-5	175-0263-01			1						LEAD,ELECTRICAL:GROUND,3 INCHES LONG	80009	175-0263-01
-6	344-0046-00			2						CLIP,ELECTRICAL:ALLIGATOR TYPE W/COVER	80009	344-0046-00
-7	166-0404-01			2						INS,SLEEVE ELEC:PLASTIC	80009	166-0404-01
-8	352-0234-00			1						HOLDER,PROBE:PLASTIC	80009	352-0234-00

P6065A PROBE

CHARACTERISTICS

Description

The P6065A Probe is a miniature passive, fast-rise 10X attenuation probe, designed for use to 100 MHz bandwidth with TEKTRONIX 465 Oscilloscope or 75 MHz with other Oscilloscope/Plug-In combinations with 20-24 pF input capacitance. The close tolerance probe resistor nearly eliminates the cascading of errors usually associated with attenuator probes.

A ground reference pushbutton on the body of the probe permits the user to obtain a ground reference or to determine which trace of a multitrace display includes the signal from the P6065A Probe. A coding ring on the BNC output connector actuates the Volts/Div readout of the oscilloscope mainframe to include the 10X attenuation of the probe. The connector is compatible with all BNC input connectors.

The compensating box houses a network that provides optimum transient response when the probe is used with wideband oscilloscopes. The probe can be low-frequency compensated to match the input of the associated instrument by adjusting the variable capacitor through the hole in the compensating box housing. The P6065A probe may be identified by a white colored plastic band around the cable boot at each end of the cable.

SPECIFICATIONS

Electrical

Attenuation: 10X within 2% (oscilloscope input $1\text{ M}\Omega \pm 2\%$) 10X within 0.4% (oscilloscope input $1\text{ M}\Omega \pm 0.15\%$).

Input Resistance:

10 $\text{M}\Omega$ within 0.5%, including 2% input resistance of amplifier.

10 $\text{M}\Omega$ within 0.25%, including 0.15% input resistance of amplifier.

See X_p , R_p vs Frequency curves.

Input Capacitance: 6 foot cable: 12.5 pF.
9 foot cable: 13.5 pF.

Compensation Range: Adjustable to match a nominal input capacitance of 20 to 24 pF.

Bandwidth (-3 dB): 100 MHz.

At least 100 MHz with 465 Oscilloscope.

Maximum Input Voltage: 500 V (DC + Peak AC), derated with frequency. See Derating curves.

General

Weight: With 6 foot (1.8 meters) cable; $\cong 5$ ounces (141.7 grams), probe and accessories. With 9 foot (2.7 meters) cable; $\cong 5.5$ ounces (155.9 grams), probe and accessories.

Dimensions:

Probe Body: $\cong 3.7$ inches (9.4 cm), length: $\cong 0.45$ inch (1.1 cm) maximum outside diameter.

Cable: Length; $\cong 6$ feet (1.8 meters), or $\cong 9$ feet (2.7 meters) between strain relief bases.

Compensation Box: Length; $\cong 1.7$ inches (4.3 cm). Width; $\cong 0.6$ inch (1.5 cm). Height; $\cong 1.2$ inches (3.0 cm).

Environmental

The probe will operate within specifications over the following ranges; Temperature, -15°C to $+75^\circ\text{C}$. Altitude, to 15,000 feet.

OPERATING INSTRUCTIONS¹

Probe Compensation

Due to slight variations in the input capacitance between oscilloscope input amplifiers (even on the same type), it is usually necessary to compensate the probe whenever it is transferred from one instrument to another, or from one channel to another of dual (multi-trace) units. Improper compensation will produce waveshape distortion and/or amplitude measurement error of the display. See Compensation Procedure for method of adjustment.

Circuit Loading

Although the DC input resistance of the P6065A is 10 $\text{M}\Omega$, it can load any high-impedance circuit it is connected into, and distort the true waveform present. To minimize this loading effect, select the lowest impedance points to check waveforms. As signal frequency increases, the equivalent probe input impedance decreases because of the input capacitance of the probe. Therefore, the probe loading increases with frequency. Fig. 2 shows R_p and X_p as a function of frequency. These curves should be referred to when making measurements of AC signals, especially in high impedance circuits.

¹Measurement Concept Booklet; Probe Measurements, TEKTRONIX Part Number 062-1120-00 is recommended treatise on probe use and measurement evaluation.

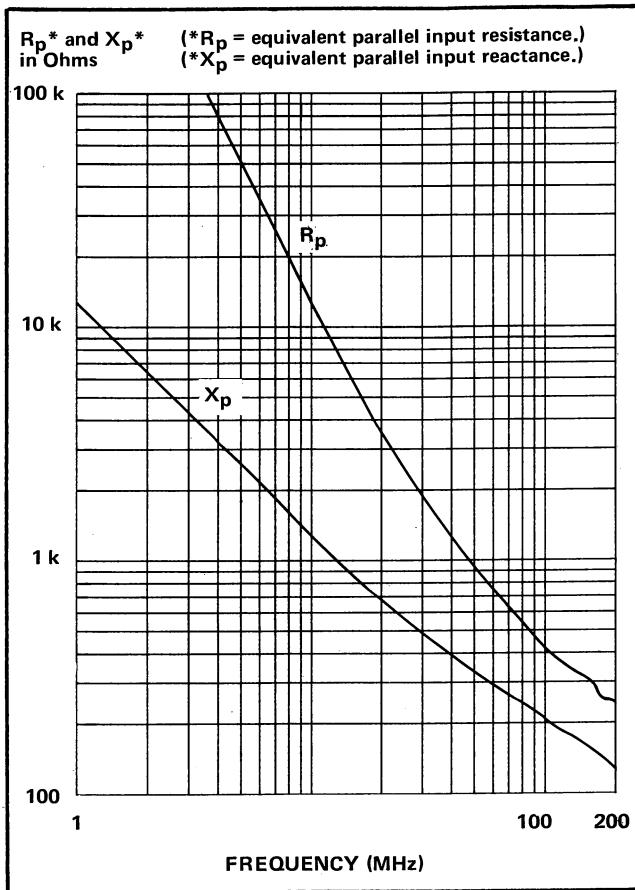

Fig. 2. P6065A Probe, typical X_p , R_p versus frequency curves.

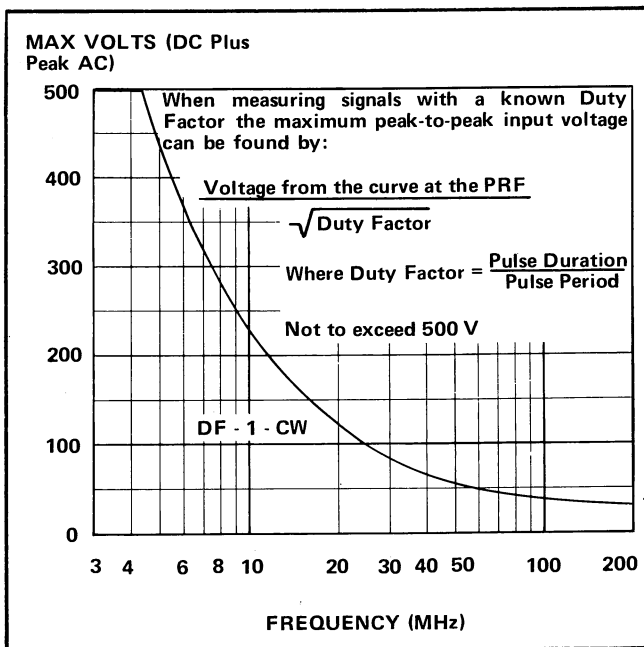

Fig. 3. P6065A Probe, typical voltage rating with frequency curve.

Maximum Input Voltage

The maximum allowable input voltage of the P6065A Probe is 500 V (DC + Peak AC) at the low-frequency end of its range. As signal frequency increases, input capacitive reactance decreases and the maximum safe input voltage decreases. Fig. 3 shows the typical voltage derating vs frequency curve.

Probe Grounding

A passive probe such as the P6065A is a capacitive divider for high-frequency components. An inductance introduced by a long ground lead will form a series resonant circuit which will "ring" if driven by a signal containing significant frequency components at or above circuit resonance. These oscillations can appear on the oscilloscope display and distort the true waveform.

Ground leads and probe tip connections should be kept as short as possible to minimize changes of "ringing".

MAINTENANCE

General

The P6065A Probe is built to withstand normal usage, but may be damaged if treated carelessly. Avoid kinking or straining the cable or subjecting the probe to extreme environmental conditions. When not in use, the probe should be stored in a drawer, or supported by the plastic holder supplied with the probe.

If the probe is damaged, replacement parts are available through your local TEKTRONIX Field Office or representative. The mechanical and electrical parts lists at the rear of this manual provide the TEKTRONIX part numbers and descriptions for the components.

Substitution of non-standard parts is not advisable if the original performance is to be restored. Even shortening the cable by more than a few percent will have a noticeable effect on the transient response of the probe. The resistive center conductor has been specifically selected for critical dampening of reflections that would otherwise exist.

Connector Replacement

1. Remove the snap-fit cover on the compensation box.

2. Unsolder the cable center conductor from the end of the resistor, then unsolder the components from the connector.

3. Loosen the 7/16-inch nut (part of the connector), unscrew, and remove the connector.

4. Install the new connector, performing steps 1 through 3 above in reverse order.

Cable Replacement

1. Remove the snap-fit cover on the compensation box.

2. Unsolder the cable center conductor from the components.

3. Remove the 7/16-inch cable bushing from the compensation box.

4. Unscrew the probe body from the cable.

5. Unsolder the cable center conductor from the resistor/capacitor lead (located in the probe head).

6. Pull the resistor/capacitor assembly from the holder.

7. Insert the resistor/capacitor assembly into the holder of the new probe cable and re-assemble the probe, reversing the procedure given in steps 1 through 6.

COMPENSATION PROCEDURE

(a). Touch the probe tip to the oscilloscope calibrator output connector and set the Volts/Div and Time/Div controls so that several cycles of the calibrator squarewave are displayed with an amplitude of approximately one-half the screen height.

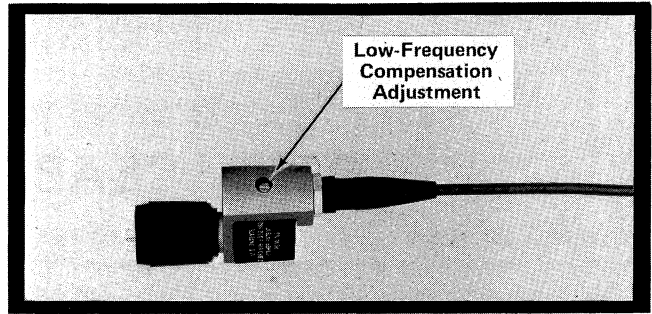

Fig. 4. Location of probe compensation adjustments.

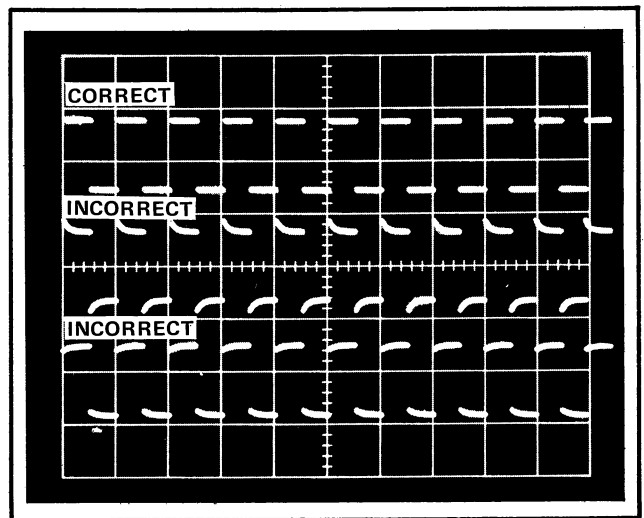

Fig. 5. Probe compensation.

(b). Adjust the probe compensation (Fig. 4) through the access hole in the compensation box, for optimum pulse flat top. Fig. 5 illustrates the correct and incorrect squarewave response.

REPLACEABLE PARTS LIST

PARTS ORDERING INFORMATION

Replacement parts are available from or through your local Tektronix, Inc. Field Office or representative.

Changes to Tektronix instruments are sometimes made to accommodate improved components as they become available, and to give you the benefit of the latest circuit improvements developed in our engineering department. It is therefore important, when ordering parts, to include the following information in your order: Part number, instrument type or number, serial number, and modification number if applicable.

If a part you have ordered has been replaced with a new or improved part, your local Tektronix, Inc. Field Office or representative will contact you concerning any change in part number.

Change information, if any, is located at the rear of this manual.

SPECIAL NOTES AND SYMBOLS

X000 Part first added at this serial number
00X Part removed after this serial number

FIGURE AND INDEX NUMBERS

Items in this section are referenced by figure and index numbers to the illustrations.

INDENTATION SYSTEM

This mechanical parts list is indented to indicate item relationships. Following is an example of the indentation system used in the description column.

1 2 3 4

Assembly and/or Component
Attaching parts for Assembly and/or Component
Detail Part of Assembly and/or Component
Attaching parts for Detail Part
Parts of Detail Part
Attaching parts for Parts of Detail Part

Attaching Parts always appear in the same indentation as the item it mounts, while the detail parts are indented to the right. Indented items are part of, and included with, the next higher indentation. The separation symbol --- * --- indicates the end of attaching parts.

Attaching parts must be purchased separately, unless otherwise specified.

ITEM NAME

In the Parts List, an Item Name is separated from the description by a colon (:). Because of space limitations, an Item Name may sometimes appear as incomplete. For further Item Name identification, the U.S. Federal Cataloging Handbook H6-1 can be utilized where possible.

CROSS INDEX

MFR. CODE NUMBER TO MANUFACTURER

MFR.CODE	MANUFACTURER	ADDRESS	CITY,STATE,ZIP
01121	Allen-Bradley Co.	1201 2nd St.	Milwaukee, WI 53212
19701	Electra/Midland Corp., A North American Phillips Co.	P. O. Box 760	Mineral Wells, TX 76067
72982	Erie Technological Products, Inc.	644 W. 12th St.	Erie, PA 16512
73743	Fischer Special Mfg. Co.	446 Morgan St.	Cincinnati, OH 45206
73899	JFD Electronics Corp.	15th at 62nd St.	Brooklyn, NY 11219
75042	TRW Electronic Components, IRC Philadelphia Div.	401 N. Broad St.	Philadelphia, PA 19108
80009	Tektronix, Inc.	P. O. Box 500	Beaverton, OR 97005
83385	Central Screw Co.	2530 Crescent Dr.	Broadview, IL 60153

SYMBOLS and REFERENCE DESIGNATORS

Electrical components shown on the diagrams are in the following units unless noted otherwise:

Capacitors= Values one or greater are in picofarads (PF).
Values less than one are in microfarads (UF).

Resistors= Ohms.

The following prefix letters are used as reference designators to identify components or assemblies on the diagrams.

C Capacitor, fixed or variable
L Inductor, fixed or variable
LR Inductor/resistor combination
R Resistor, fixed or variable

ABBREVIATIONS

ASSY	ASSEMBLY	ID	INSIDE DIAMETER
BRS	BRASS	INS	INSULATED
CAP	CAPACITOR	MKR	MARKER
CER	CERAMIC	MTG	MOUNTING
CKT	CIRCUIT	OBD	ORDER BY DESCRIPTION
CMPSN	COMPOSITION	OD	OUTSIDE DIAMETER
COMP	COMPENSATION	P BRZ	PHOSPHOR BRONZE
CONN	CONNECTOR	RCPT	RECEPTACLE
ELEC	ELECTRICAL	RES	RESISTOR
FXD	FIXED	TECH	TECHNICAL
HEX	HEXAGON	VAR	VARIABLE
IC	INTEGRATED CIRCUIT	W/	WITH

ELECTRICAL PARTS LIST

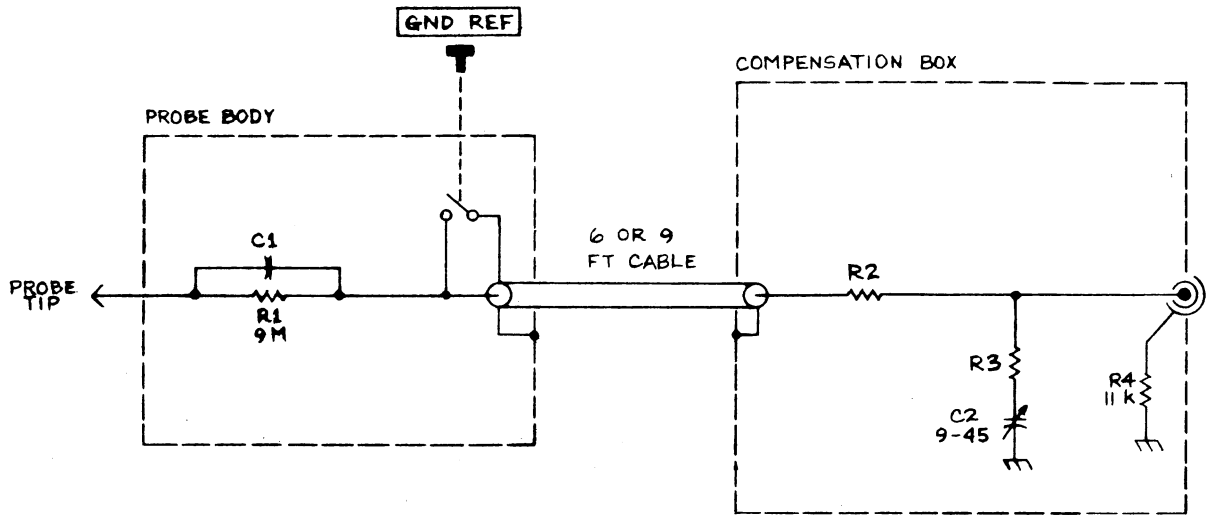

P6065A 10X PROBE

COMPONENT	6 FT CABLE	9 FT CABLE
C1	11.4	12.8
R2	127	100
R3	110	200

Ckt No.	Tektronix Part No.	Serial/Model No. Eff	Dscont	Name & Description	Mtr Code	Mfr Part Number
6 FOOT PROBE						
C1 ¹	-----			CAP.,FXD,CER DI:11.4PF,1%,500V		
C2	281-0171-00			CAP.,VAR,MICA D:9-45PF,200V	72982	538-002D15-45
R1 ¹	-----			RES.,FXD,FILM:9M OHM,0.1%,0.25W		
R2	322-0107-00			RES.,FXD,FILM:127 OHM,1%,0.25W	75042	CCAT0-1270F
R3	315-0111-00			RES.,FXD,CMPSN:110 OHM,5%,0.25W	01121	CB1115
R4	317-0113-00			RES.,FXD,CMPSN:11K OHM,5%,0.125W	01121	BB1135
9 FOOT PROBE						
C1 ²	-----			CAP.,FXD,CER DI:12.8PF,1%,500V		
C2	281-0171-00			CAP.,VAR,MICA D:9-45PF,200V	72982	538-002D15-45
R1 ²	-----			RES.,FXD,FILM:9M OHM,0.1%,0.25W		
R2	322-0097-00			RES.,FXD,FILM:100 OHM,1%,0.25W	19701	MF52C1000F
R3	322-0126-00			RES.,FXD,FILM:200 OHM,1%,0.25W	75042	CEBT9-2000C
R4	317-0113-00			RES.,FXD,CMPSN:11K OHM,5%,0.125W	01121	BB1135

¹Available as assembly 206-0204-00 only.

²Available as assembly 206-0205-00 only.

MECHANICAL PARTS LIST

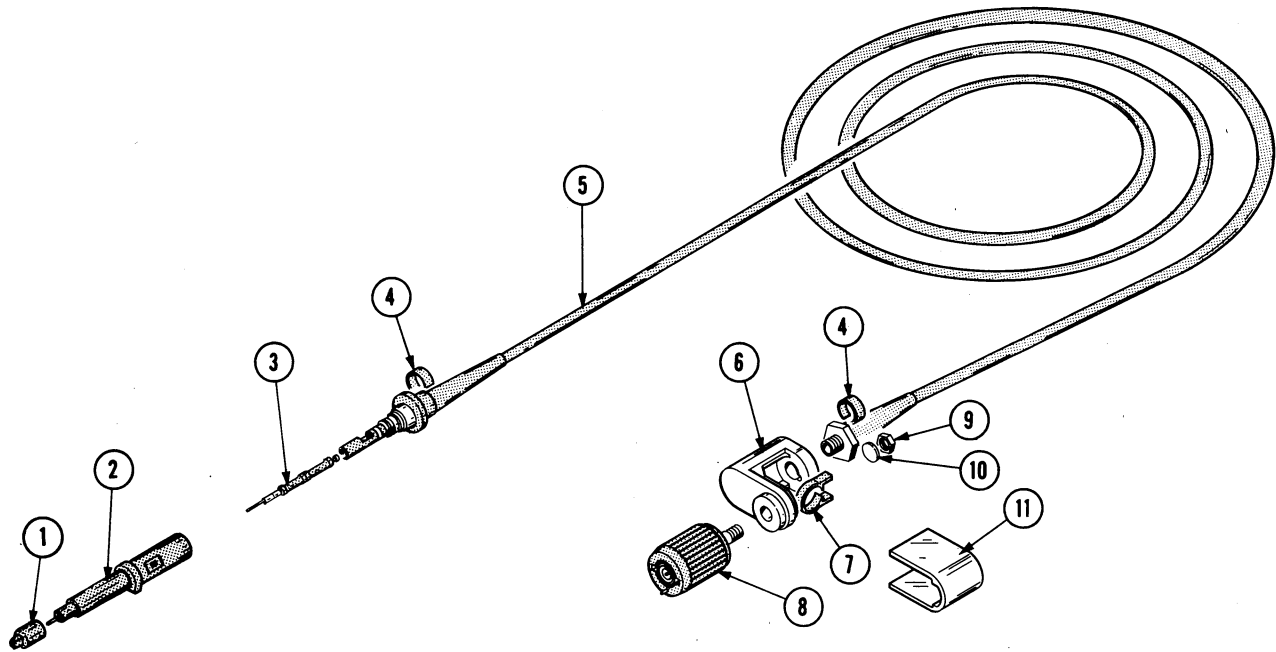

Fig. & Index No.	Tektronix Part No.	Serial/Model No. Eff	Dscnt	Qty	Name & Description					Mfr Code	Mfr Part Number
					1	2	3	4	5		
	010-6065-12			1	PROBE:P6065A,6 FOOT					80009	010-6065-12
	010-6065-14			1	PROBE:P6065A,9 FOOT					80009	010-6065-14
	- - - - -			-	PROBE INCLUDES:						
-1	015-0201-00			1	TIP,PROBE:IC TEST					80009	015-0201-00
-2	204-0579-01			1	BODY ASSEMBLY:PROBE					80009	204-0579-01
-3	206-0204-00			1	ATTENUATOR ASSY:(FOR 6 FOOT ONLY)					80009	206-0204-00
	206-0205-00			1	ATTENUATOR ASSY:(FOR 9 FOOT ONLY)					80009	206-0205-00
-4	334-1636-02			2	BAND,MKR,CABLE:WHITE					80009	334-1636-02
-5	175-1383-00		7426	1	CABLE ASSEMBLY:(FOR 6 FOOT ONLY)					80009	175-1383-00
	175-1383-01	7427		1	CABLE ASSEMBLY:(FOR 9 FOOT ONLY)					80009	175-1383-01
	175-1400-00		7426	1	CABLE ASSEMBLY:(FOR 6 FOOT ONLY)					80009	175-1400-00
	175-1400-01	7427		1	CABLE ASSEMBLY:(FOR 9 FOOT ONLY)					80009	175-1400-01
-6	426-0690-04			1	FRAME,HSG ASSY:COMPENSATION BOX					80009	426-0690-04
-7	354-0396-00			1	RING,CAP.,MTG:					80009	354-0396-00
-8	131-1070-00			1	CONN,RCPT,ELEC:WITH READOUT PIN (ATTACHING PARTS)					80009	131-1070-00
-9	220-0572-00			1	NUT,PLAIN,HEX.,10-32 X 0.25 INCH,BRS					73743	OBD
-10	210-0056-00			1	WASHER,LOCK:SPLIT,0.195 ID x 0.32" OD,P BRZ - - - * - - -					83385	OBD
-11	200-1158-11			1	COVER,COMP:(FOR 6 FOOT ONLY)					80009	200-1158-11
	200-1158-12			1	COVER,COMP:(FOR 9 FOOT ONLY)					80009	200-1158-12
	070-1596-00			1	MANUAL,TECH:(NOT SHOWN)					80009	070-1596-00