

User Manual

Tektronix

**2712
Spectrum Analyzer**

070-8137-02

Warning

The servicing instructions are for use by qualified personnel only. To avoid personal injury, do not perform any servicing unless you are qualified to do so. Refer to the Safety Summary prior to performing service.

Please check for change information at the rear of this manual.



Copyright © Tektronix, Inc. All rights reserved.

Tektronix products are covered by U.S. and foreign patents, issued and pending. Information in this publication supercedes that in all previously published material. Specifications and price change privileges reserved.

Printed in the U.S.A.

Tektronix, Inc., P.O. Box 1000, Wilsonville, OR 97070-1000

TEKTRONIX and TEK are registered trademarks of Tektronix, Inc.

WARRANTY

Tektronix warrants that this product will be free from defects in materials and workmanship for a period of one (1) year from the date of shipment. If any such product proves defective during this warranty period, Tektronix, at its option, either will repair the defective product without charge for parts and labor, or will provide a replacement in exchange for the defective product.

In order to obtain service under this warranty, Customer must notify Tektronix of the defect before the expiration of the warranty period and make suitable arrangements for the performance of service. Customer shall be responsible for packaging and shipping the defective product to the service center designated by Tektronix, with shipping charges prepaid. Tektronix shall pay for the return of the product to Customer if the shipment is to a location within the country in which the Tektronix service center is located. Customer shall be responsible for paying all shipping charges, duties, taxes, and any other charges for products returned to any other locations.

This warranty shall not apply to any defect, failure or damage caused by improper use or improper or inadequate maintenance and care. Tektronix shall not be obligated to furnish service under this warranty a) to repair damage resulting from attempts by personnel other than Tektronix representatives to install, repair or service the product; b) to repair damage resulting from improper use or connection to incompatible equipment; or c) to service a product that has been modified or integrated with other products when the effect of such modification or integration increases the time or difficulty of servicing the product.

THIS WARRANTY IS GIVEN BY TEKTRONIX WITH RESPECT TO THIS PRODUCT IN LIEU OF ANY OTHER WARRANTIES, EXPRESSED OR IMPLIED. TEKTRONIX AND ITS VENDORS DISCLAIM ANY IMPLIED WARRANTIES OF MERCHANTABILITY OR FITNESS FOR A PARTICULAR PURPOSE. TEKTRONIX' RESPONSIBILITY TO REPAIR OR REPLACE DEFECTIVE PRODUCTS IS THE SOLE AND EXCLUSIVE REMEDY PROVIDED TO THE CUSTOMER FOR BREACH OF THIS WARRANTY. TEKTRONIX AND ITS VENDORS WILL NOT BE LIABLE FOR ANY INDIRECT, SPECIAL, INCIDENTAL, OR CONSEQUENTIAL DAMAGES IRRESPECTIVE OF WHETHER TEKTRONIX OR THE VENDOR HAS ADVANCE NOTICE OF THE POSSIBILITY OF SUCH DAMAGES.

TABLE OF CONTENTS

Operators Safety Summary

Terms In This Manual	ix
Terms Marked On Equipment	ix
AC Power Source	x
DC Power Source	x
Product Grounding	x
Input Power and Voltage Limitations.....	xi
Use The Proper Fuse	xii
General Precautions.....	xii

Section 1 —Introduction

Manual Organization	1-1
Typographical Conventions.....	1-3
What Is a Spectrum Analyzer?.....	1-5
What Can You Do with a Spectrum Analyzer?	1-6
About the 2712	1-6

Section 2 —Specifications

Electrical Characteristics.....	2-1
Environmental Specifications.....	2-13
Physical Specifications.....	2-14

Section 3 —Getting Acquainted With Your Instrument

Receiving and Unpacking	3-1
Repackaging and Storing.....	3-1
Installation	3-2
Precautions	3-3
System Checkout	3-4
Turning on the 2712.....	3-4
Initial Normalization.....	3-6
Restoring the Factory Default Settings	3-7
The Initial Display	3-8
Control Panel Basics.....	3-10
Sounds.....	3-12
The Built-in Calibrator.....	3-12
Making Your First Measurement.....	3-13

Section 4 —Operation Summary

Display Screen	4-1
Connectors, Controls, and Menus	4-3

Section 5 —Dedicated Controls

Fundamental Operations	5-1
SPAN/DIV ↓ ↑	5-2
MAX (Span)	5-4
ZERO (Span)	5-4
FREQUENCY ↓ ↑ and FREQ/MKRS Knob	5-5
REF LEVEL ↓ ↑	5-7
REF LVL STEP	5-9
Enhanced Versatility	5-10
RES BW	
↓ ↑	5-10
AUTO	5-13
VID FLTR	5-13
VERT SCALE	
10/5/1	5-15
LIN	5-16
SWEEP	
↓ ↑	5-16
AUTO	5-18
SINGLE	5-19
LEVEL	5-20
DISPLAY STORAGE	
A B C D (Turning registers on and off)	5-21
Analog Display	5-22
SAVE ENABLE A B C	5-23
Register Priority	5-24
SAVE ENABLE D (Waterfall mode)	5-25
MAX HOLD A & B	5-27
FREQ/MKRS	
MKR/Δ/OFF	5-28
CTR-MEAS/TRKG	5-31
MKR ◀ ▶	5-34
PEAK FIND	5-35
Miscellaneous Controls	
PLOT	5-35
READOUT	5-37
INTENSITY	5-37
TRACE ROT, VERT POS, HORIZ POS	5-38

Section 6 —Software Control - The Menus

INPUT	6-5
Turning the Calibrator On and Off	6-5
Setting the RF Attenuation	6-6
Changing Reference Level Units	6-7
Accommodating External Amplification/Attenuation	6-7
Accommodating a 75 Ohm Source	6-8
Setting the First Mixer Input Level	6-11
Turning the Preamplifier On and Off	6-12
Using the dBUV/M	6-13
MKR/FREQ	6-22
Setting the Start and Stop Frequencies	6-22
Using Markers to Set Start and Stop Frequencies	6-22
Transposing Markers	6-23
Changing the Knob Function	6-24
Moving the Marker to the Next Higher or Lower Peak	6-26
Marker to the Reference Level	6-26
Selecting the Tuning Increment	6-27
Center or Start Frequency	6-28
Setting the Signal Threshold	6-28
Counter Resolution	6-29
Programmed Tuning	6-30
Tabular Tuning	6-32
Frequency Offsets	6-33
DSPL	6-34
Changing Display Mode	6-35
Ensemble Averaging	6-36
Subtracting Stored Signals	6-40
Changing Acquisition Mode	6-44
Adding Titles and Labels	6-44
Turning the Graticule On and Off	6-47
Displaying an External Source	6-48
The Display Line and Limit Detector	6-48
Activating Minimum Hold	6-50
APPL	6-51
Measuring Signal Bandwidths	6-52
Measuring Average Noise	6-53
Measuring Carrier-To-Noise Ratios	6-55

Searching for Signals.....	6-57
Measuring Occupied Bandwidths (OBW)	6-59
Making EMI/EMC Measurements	6-63
Quasi-peak Measurements (Option 12 only)	6-66
Viewing Instantaneous Frequency Deviation	6-70
DEMOD/TG	6-72
Listening to FM Transmissions.....	6-73
Listening to AM Transmissions	6-73
Listening to FM or AM Transmissions	6-74
Video Demodulation (Option 10 only)	6-74
Using the Tracking Generator (Option 04 only)	6-77
Turning the Tracking Generator On and Off	6-78
Normalizing the Tracking Generator.....	6-79
Setting the Tracking Generator Amplitude.....	6-81
Adjusting the Tracking	6-82
Using External	
Amplification/Attenuation With the TG	6-84
A Practical Example	6-86
UTIL	6-87
Menu-Entered Control Settings.....	6-87
Saving and Recalling Settings and Displays.....	6-89
Recalling Last Power-Down Settings	6-89
User-Defined Power-Up Settings	6-90
Other User-Defined Settings.....	6-91
Normalizing the 2712.....	6-93
System Configuration.....	6-95
Configuring the Communications Port.....	6-96
GPIB Configuration	6-96
RS-232 Configuration	6-98
Selecting the Screen Plotter Configuration.....	6-99
Selecting the Printer Configuration	6-101
Instrument Configuration	6-101
The Audio Alert.....	6-101
Setting the Minimum Signal Size	6-102
Sending Waveforms to a Computer	6-102
Turning Phase Lock On and Off.....	6-103
Turning Frequency Corrections On and Off.....	6-103
The Spectral Display in Menus.....	6-104
Changing the Sweep Holdoff.....	6-104
Setting the Date and Time	6-105
Protecting Stored Settings	6-105

The 2712 File System	6-106
Protecting Files	6-106
Confirming Installed Options	6-108
Instrument Diagnostics and Adjustments	6-109
Aligning the Display with the Screen	6-109
Service Normalizations	6-110
If You Lose NVRAM.....	6-111
Generating a Service Request	6-112
Printing the On-screen Readouts	6-113
SWP/TRIG	6-113
Free Running the Sweep Generator	6-114
Oscilloscope Trigger Modes.....	6-114
TV Line Triggering.....	6-116
TV Video Field Triggering	6-119
Setting the Sweep Rate	6-120
Manually Scanning	6-120
USER DEF	6-121
Section 7 —External Input and Output	
Mains Power.....	7-1
J101 -- TV Sideband Adapter Interface.....	7-1
J102 -- External Trigger	7-2
J103 -- Accessory Connector	7-3
Pin 1 -- External Video Input.....	7-4
Pin 2 -- Chassis and Signal Ground	7-5
Pin 3 -- Video Output.....	7-5
Pin 6 -- Sweep Gate	7-6
Pin 7 -- Sweep Ramp	7-7
J104 -- Digital Communications Port.....	7-8
Appendix A -- Broadcast AM, FM, and TV Signal Sources.....	
Appendix A -- Broadcast AM, FM, and TV Signal Sources.....	A-1
Appendix B -- System Messages	B-1
Appendix C -- 2712 Global Resets.....	C-1
Appendix D -- Accessories and Options	D-1
Index	I-1

LIST OF ILLUSTRATIONS

Figure 1-1. Spectrum analyzer block diagram.	1-9
Figure 3-1. 2712 display with factory power-up settings.	3-8
Figure 3-2. Normal on-screen data readouts.	3-9
Figure 3-3. The 2712 primary controls.	3-15
Figure 3-4. 2712 calibration signal and harmonics.	3-16
Figure 3-5. Calibration signal fundamental.	3-20
Figure 4-1. Layout of the text screen in spectral display mode.	4-2
Figure 4-2. Layout of the text screen in menu display mode.	4-2
Figure 4-3. The frequency/marker function block.	4-4
Figure 4-4. Fundamental analyzer controls.	4-6
Figure 4-5. The keypad.	4-8
Figure 4-6. Display register control.	4-9
Figure 4-7. Vertical scale and other controls.	4-10
Figure 4-8. Resolution BW and sweep control.	4-12
Figure 4-9. The 2712 back panel.	4-14
Figure 5-1. Example of a waterfall display.	5-26
Figure 5-2. Typical plotter output from the 2712 showing a cable television spectrum.	5-36
Figure 6-1. The Input Menu.	6-2
Figure 6-2. Reference Level Units Menu.	6-3
Figure 6-3. Sweep/Trigger Menu with SWEEP RATE selection chosen.	6-3
Figure 6-4. 75/50 ohm matching minimum loss pad.	6-11
Figure 6-5. Equipment setup for field strength measurements.	6-15
Figure 6-6. Average signal plus noise and average signal- plus-noise subtracted from the current sweep.	6-41
Figure 6-7. Average MEAN noise and MAX HOLD signal-plus-noise spectra.	6-42
Figure 6-8. B, C MINUS A OFFSET TO CENTER.	6-43
Figure 6-9. B, C MINUS A OFFSET TO TOP.	6-43
Figure 6-10. 2712 plot with title and plot labels.	6-47
Figure 6-11. The SIGNAL SEARCH frequency range.	6-58

- Figure 6-12. Illustration of Occupied BW measurement.. 6-60
- Figure 6-13. Portion of U.S. broadcast FM band..... 6-61
- Figure 6-14. OCCUPIED BW mode with MAX HOLD... 6-62
- Figure 6-15. Instantaneous frequency deviation
and maximum observed deviation. 6-72
- Figure 6-16. 2712 screen in video monitor mode. 6-76
- Figure 6-17. Equipment setup for tracking generator
measurement of 50-ohm devices..... 6-78
- Figure 6-18. Bandpass filter response using
the 2712 optional tracking generator
and B,C MINUS A mode. 6-86
- Figure 6-19. Video field using internal
or TV field triggering. 6-115
- Figure 6-20. Video signal using continuous
horizontal line triggering..... 6-117
- Figure 6-21. Video signal using knob-selectable
horizontal line triggering (VITS visible)..... 6-119
- Figure 7-1. Accessory connector (J103). 7-3
- Figure 7-2. Sweep gate and ramp timing. 7-7
- Figure 7-3. IEEE Standard 488 (GPIB)
connector pin assignments. 7-9
- Figure 7-4. EIA Standard RS-232 (C)
connector pin assignments. 7-9

LIST OF TABLES

Table of safe maximum signal levels.....	x
Table 2-1. Frequency related characteristics.....	2-2
Table 2-2. Frequency/amplitude related characteristics.....	2-4
Table 2-3. Amplitude related characteristics.....	2-5
Table 2-4. Input/output signal characteristics.....	2-7
Table 2-5. Power requirements.....	2-8
Table 2-6. General characteristics.....	2-9
Table 2-7. Electrical characteristics of instrument options.....	2-10
Table 2-8. Environmental characteristics.....	2-13
Table 2-9. Physical characteristics.....	2-14
Table 2-10. Certifications and Compliances.....	2-15
Table 2-11. Safety Standards.....	2-16
Table 2-12. Safety Certification Compliance.....	2-16
Table 4-1. The Sweep/Trigger (SWP/TRIG) Menu.....	4-15
Table 4-2. The Utility (UTIL) Menu.....	4-16
Table 4-3. The Marker/Frequency (MKR/FREQ) Menu.....	4-20
Table 4-4. The Applications (APPL) Menu.....	4-22
Table 4-5. The Demodulator/Tracking Generator (DEMOTG) Menu.....	4-24
Table 4-6. User Definable (USER DEF) Menu.....	4-25
Table 4-7. The Display (DSPL) Menu.....	4-26
Table 4-8. The Input (INPUT) Menu.....	4-28
Table 6-1. Equivalent decibel - voltage values.....	6-17
Table 6-2. Video filter selection in EMC and QP modes.....	6-65
Table 6-3. Typical 2712 parameters in normal and EMC modes.....	6-66
Table 6-4. Maximum spans/div and total spans in QP mode.....	6-68
Table 6-5. The 2712 file system.....	6-107
Table D-1. Standard accessories.....	D-1
Table D-2. Optional power cords.....	D-1

OPERATORS SAFETY SUMMARY

The general safety information in this part of the manual is for operating personnel. Specific warnings and cautions may also be found throughout the manual where they apply.

TERMS IN THIS MANUAL



This symbol identifies conditions or practices that could result in damage to the equipment or other property.

WARNING

This symbol identifies conditions or practices that could result in personal injury or loss of life.

TERMS MARKED ON EQUIPMENT

CAUTION indicates a personal injury hazard not immediately accessible as one reads the markings, or a hazard to property, including the equipment itself.

DANGER indicates a personal injury hazard immediately accessible as one reads the marking.



means "Caution, refer to the manual for additional information".

AC POWER SOURCE

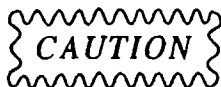

To prevent damage to the 2712 Spectrum Analyzer, operate it only from appropriate AC mains sources.

Damage to the instrument can occur if the 50-60 Hertz AC power source applies more than 250 VAC rms between conductors, or between either conductor and ground. See Table 2-5 in the *Specifications* section for additional information.

DC POWER SOURCE

The 2712 Analyzer can be powered from the optional model 2704/2705 DC-to-AC Inverter and external DC battery pack. The Analyzer will run for about one hour on a fully charged 2705 Battery Pack, and for extended periods of time on alternate DC sources. See the *2704 DC-to-AC Inverter and 2705 Battery Pack* instruction manual for further information.

PRODUCT GROUNDING

WARNING

To prevent potentially hazardous voltages from existing on the exposed metal parts of the 2712, always use the Analyzer protective ground.

The 2712 is earthed by the protective grounding lead of its AC power cord. Upon loss of the protective ground connection, all accessible conductive parts of the analyzer can render an electric shock.

INPUT POWER AND VOLTAGE LIMITATIONS

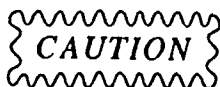

The safe maximum total RF input power for the 2712 Spectrum Analyzer is +20 dBm (+67dBmV). DC input voltage is limited to 100 VDC maximum.

Total input power above the rated maximum can cause damage to the instrument, and voids the factory warranty. For a number of equal amplitude signals, the total power is approximately:

$$\begin{array}{l} \text{Total} \\ \text{Signal} \\ \text{(dBm)} \end{array} = \begin{array}{l} \text{Single} \\ \text{Signal} \\ \text{(dBm)} \end{array} + 10 \log (\text{Number of Signals})$$

Thus, the safe maximum amplitude per signal is given below:

Table of safe maximum signal levels.

Number of Signals Input to Analyzer	Safe Maximum Amplitude per Signal (dBm)
1	+20.0
10	+10.0
30	+5.2
50	+3.0
70	+1.5
100	0.0

Remember, two 18 dBm signals total more than 20 dBm! Higher signal levels should be externally attenuated.

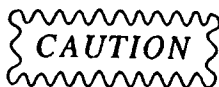

To avoid overloading the analyzer and possibly damaging it, do not place AC or DC power supply voltages on the input of the Spectrum Analyzer.

USE THE PROPER FUSE

For continued fire protection, observe the fuse specifications located on the back panel of the 2712 Spectrum Analyzer.

GENERAL PRECAUTIONS

WARNING

Using the 2712 Spectrum Analyzer in wet/damp conditions or inclement weather may result in electric shock or damage to the instrument.

Always allow at least 2" clearance adjacent to the ventilation holes at the sides, bottom, and back of the Analyzer case.

The 2712 can be damaged by incorrect AC supply voltages, RF inputs that exceed the maximum ratings, operation in very high temperatures or without adequate ventilation, immersion in liquids, and physical abuse.

To avoid explosion, do not operate this product in explosive atmospheres unless it has been specifically certified for such operation.

To avoid personal injury, do not remove covers or panels, or operate the analyzer without the protective covers installed.

To avoid the possibility of overheating, do not operate the 2712 Spectrum Analyzer in a carrying case.

Refer internal service and adjustment to qualified service personnel.

SECTION
1

INTRODUCTION

SECTION 1

INTRODUCTION

This section describes the manual you are reading, and introduces you to the basic concepts behind RF spectrum analyzers and the 2712 Spectrum Analyzer in particular.

MANUAL ORGANIZATION

The manual is divided into three parts. The first part (section 1 through 4) contains reference material that enables the beginning or experienced operator to safely power up and initially normalize the 2712.

The second part of the manual consists of sections 5 through 7. These provide detailed explanations, and some measurement examples which may be especially useful to the novice spectrum analyst. They should be read interactively with the 2712; carry out the instructions using the spectrum analyzer. In this way you quickly acquire the knowledge and skills necessary to confidently make accurate measurements.

Part 3 of the manual consists of several appendices and an index. The appendices contain information about a number of topics useful, but not essential, to operating the 2712.

The experienced operator may find that sections 2 and 4, *Specifications* and *Operation Summary*, provide most of the information needed for routine operations. However, a newcomer to spectrum analysis, may find the material in sections 1 and 3, *Introduction* and *Getting Acquainted With Your Instrument*, especially helpful. Section 1 contains a brief description of spectrum analysis and reviews the characteristics of the Tektronix 2712 Spectrum Analyzer. Section 3 enables you to safely apply power and signals to the 2712. You become acquainted with the fundamental controls of the instrument and make your first measurement using the built-in calibration signal. For additional information, we recommend that you also read Tektronix application note 26W-7037-1, *Spectrum Analyzer Fundamentals*.

The second part of the manual is divided into small lessons. The end of one lesson and start of the next are indicated by a "settings box" that looks like this:

100.0MHZ	(AUTO SWEEP)	ATTN 10DB
-20.0DBM		VF WIDE
20.0MHZ/		10 DB/
5MHZ RBW (AUTO)		

The box shows what the control settings of the 2712 should be to continue with the lesson which follows it. The contents of the box resemble the analyzer's standard on-screen data readouts. Each lesson begins with the sweep and resolution bandwidth controls in AUTO mode. To remind you of this, (AUTO SWEEP) is shown in the top center of the box and (AUTO) follows the resolution bandwidth setting. The parentheses mean the enclosed item is not part of the normal on-screen readouts.

If you are inexperienced with spectrum analyzers, we recommend that you proceed serially through the second part of the manual. Although each section can stand alone, they have been written to acquaint you with the most important features of the analyzer first, and to yield increased experience with previously-discussed controls as you proceed through the more advanced portions.

Sections 5 and 6, *Dedicated Controls* and *Software Controls - The Menus*, explain - with the help of examples you carry out - the features of the 2712 and the benefits you gain from each control and menu option. You learn to easily obtain accurate *spectral and time-domain measurements*.

Section 7, *External Input and Output*, teaches you how to get signals in and out of the back panel of your spectrum analyzer.

If you are already familiar with the 2712, this manual can serve as a "how to" reference. Check the index or table of contents for the location of the subject of interest. Then set the analyzer according to the corresponding settings box, and refresh your memory by carrying out the example following the box.

TYPOGRAPHICAL CONVENTIONS

A few typographical conventions are used to make this manual more convenient to use. Text consists of information and instructions. Instructions are printed in **bold type** to distinguish them from purely informational statements. For example, the instruction:

**"Change the center frequency by turning the
FREQ/MARKERS knob."**

is distinguished from the informational statement:

"Turning the **FREQ/MARKERS** knob changes the frequency."

by the **bold** text.

Textual information that appears on the spectrum analyzer screen, such as the data in the readout areas, is printed as it appears on screen, in bold **sans serif** font. For instance, the span per division and resolution bandwidth appear in the upper left of the screen in this format:

**20.0 MHZ/
3 KHZ RBW**

The keys on the 2712 Spectrum Analyzer are usually represented by square brackets enclosing the name of the key. The names are printed in **sans serif** font as they appear on the spectrum analyzer front panel, except that names occupying more than one line on the analyzer are printed on a single line. For instance, if we tell you to **press**:

[REF LVL STEP]

we mean **Press the key (in the top center function block of the 2712 control panel) that looks like:**

**REF LVL
STEP**

Notice that on the analyzer, the key names may be printed on the key or directly above the key.

When we want you to press a series of keys, we print the series using slashes (/) as delimiters. For instance, if we tell you to **press:**

[UTIL]/[1]/[1]

we mean **sequentially press the UTIL key, the 1 key, and the 1 key a second time.**

When selection of an item from a menu is required, the item number, its description as it appears on the menu, or both are given. For instance, soon you will select item 9 from the Input Menu. This is how the description of item 9 appears on the menu and in text:

CAL SIG @ 100MHZ -30DBM

Text which refers to the title of another section of this manual, or of another publication, is printed in *bold italics*. For instance, we might suggest that you:

"...see the *Operation Summary* section for..."

If another publication is referenced, its complete title and Tektronix publication number are supplied.

WHAT IS A SPECTRUM ANALYZER?

There are several types of spectrum analyzers, but we will describe only the *heterodyne* or *scanning* analyzer. A scanning RF spectrum analyzer is essentially a radio receiver. Imagine you tune a conventional FM broadcast receiver from one end of the band to the other. As you tune, plot the reading of the signal level meter versus frequency. The graph you produce is a *frequency domain* representation, or *spectrum*, of the FM broadcast band; it tells you at which frequencies the signals occur and how strong they are. If stations are too close together, you will hear them simultaneously and you will not be able to get an independent meter reading for each. This is because the intermediate frequency (IF) filter of the receiver has a bandwidth too wide to *resolve*, or separate, the stations.

In this thought-experiment, you are manually tuning, or scanning, the FM broadcast band with a *resolution bandwidth* equal to the bandwidth of the IF filter in your receiver. Suppose you plot your measurements on graph paper with one centimeter divisions, making each division equal one megahertz. The *span/division* of the resulting plot is then 1 MHz/division.

If you stop tuning, the receiver no longer spans a range of frequencies, but is fixed at the currently selected frequency; it is in *zero span* mode. The output of the receiver depends on the signal coming through the IF filter at the selected frequency. After detection, the sound you hear is proportional to the modulating signal amplitude. If you plot the amplitude of the signal as a function of time (or view it on an oscilloscope-type display) you create a *time-domain* representation (signal amplitude vs. time).

A spectrum analyzer performs similarly except that the scan is usually performed automatically (and faster than you do it manually) and there is a selection of IF bandwidths or resolution bandwidths to choose from. Multiple resolution BWs are needed because in some cases you want to separate closely-

spaced, narrowband signals, while in others you will want to examine signals with larger bandwidths. There is a maximum speed at which a band can be accurately scanned with a resolution BW of a given width; generally the smaller the resolution BW, the slower the speed. The 2712 can automatically select the fastest speed for you.

You can find additional information about basic spectrum analyzer concepts and definitions in Tektronix application note 26W-7037-1, *Spectrum Analyzer Fundamentals*.

WHAT CAN YOU DO WITH A SPECTRUM ANALYZER?

Spectrum analyzers measure how the power in an input signal is distributed in frequency. Therefore, you can use them to determine signal amplitudes and frequencies, noise power, carrier-to-noise (C/N) ratios, signal or filter bandwidths, distortion (harmonic and intermodulation), FM deviation, percent modulation, detect spurious signals, align transmitters and receivers, check specifications, and so forth.

ABOUT THE 2712

The Tektronix 2712 is a portable radio frequency (RF) scanning spectrum analyzer designed for use in the field as well as the shop. It is light weight (less than 9.5 kg/22 lbs) and can be equipped with battery and inverter for use in locations without AC power. The instrument is very durable, but rough handling, or liquids, dust, or other contaminants inside the case can cause damage. The optional Travel Line package provides additional protection during transportation.

The 2712's user interface is simple enough for the neophyte but versatile enough to satisfy an expert. Fundamental measurement parameters (center frequency, span/division, reference level, etc.) can be controlled directly with dedicated keys. In fact, as you'll learn in section 3, you can display a spectrum by touching only three controls. Making measurements can be so easy that even experienced engineers get the feeling of "1, 2, 3...how

simple can it get?" On the other hand, call-up menus enable you to automate certain operations, such as bandwidth or carrier-to-noise ratio measurements, and to directly enter front-panel control settings. Measurement parameters and results are displayed on-screen.

To increase measurement flexibility, the 2712 has a broad range of standard features. Input signal sensitivity with the built-in preamp activated can be as low as -139 dBm, and signals as large as +20 dBm can be accommodated. A frequency-corrected oscillator provides accuracy of 5×10^{-7} of center frequency ± 10 Hz ± 1 LSB. AUTO operation allows both sweep speed and resolution bandwidth to be selected automatically. Digital and analog displays are standard, as are time-domain functions (with 1 μ sec/div sweep speed in analog mode), AM/FM detection, built-in preamplifier, user-definable modes, and 300 Hz - 5 MHz resolution BWs.

Post-detection digital sampling (at a 2.5 MHz conversion rate) and storage is used with a unique max/min display mode that provides a close approximation of analog displays. Peak detection is also provided. It is possible to display up to four traces simultaneously and to perform ensemble statistics. A continuously updated "waterfall" display mode can be used to compare the four most recent spectral sweeps. A GPIB digital communications port is standard. Non-volatile random access memory (NVRAM) enables you to save up to 36 front-panel configurations and a number of spectral sweeps -- 124 kbyte of NVRAM is provided. The exact storage capability depends on what else you are storing in the instrument (such as user-defined keystroke sequences).

Optional 2712 capabilities result in even greater performance.

- Option 04¹ : Built-in tracking generator for swept frequency measurements
- Option 10: Video monitor for broadcast or satellite TV reception
- Option 12¹: Quasi-peak detection and 200 Hz, 9 kHz, and 120 kHz resolution BW filters for EMC/EMI measurements
- Option 14¹: Additional resolution BW filters (1 kHz, 10 kHz, 100 kHz, 1 MHz)

Figure 1-1 illustrates how the 2712 is put together. As you proceed through this manual, you may find it useful to refer to this block diagram to understand how the various features of the analyzer operate.

NOTE

Because Tektronix continually improves its products, it is possible there may be a few differences in how your 2712 operates compared to the description in this document. Check with Tektronix if further information is needed.

¹ Options 04, 12, and 14 are mutually exclusive.

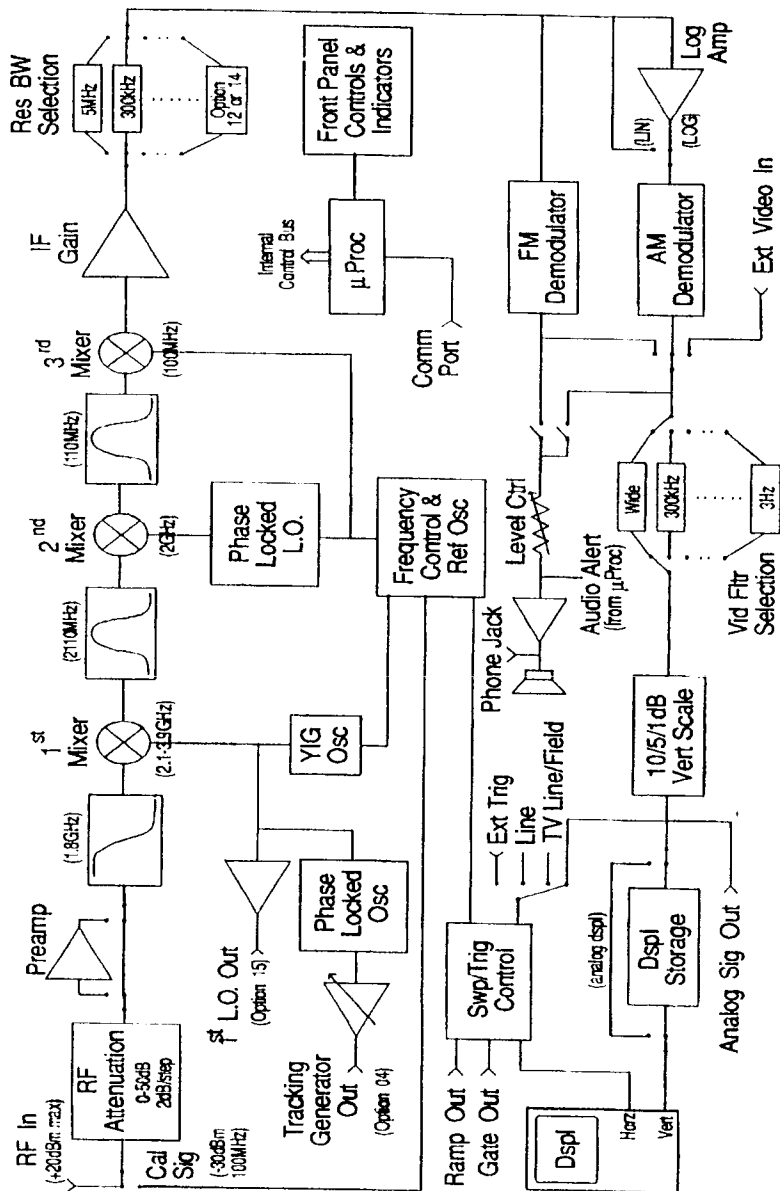

Figure 1-1. Spectrum analyzer block diagram.

SECTION
2

SPECIFICATIONS

SECTION 2

SPECIFICATIONS

This section lists the electrical, physical, and environmental characteristics of the Spectrum Analyzer, specifies the performance requirements for those characteristics, and provides other supplementary information. Changes to a characteristic because of the addition of an option are included in the characteristic's specification.

ELECTRICAL CHARACTERISTICS

Unless otherwise stated, the following tables of electrical characteristics and features apply to the 2712 Spectrum Analyzer after a 15 minute warm-up period (within the environmental limits) and after all normalization procedures have been carried out.

Information in the Performance Requirement column is guaranteed and verifiable. Supplemental information is intended to further explain a characteristic, its performance requirement, or to describe characteristic performance that is impractical to verify. Supplemental information is not guaranteed and may not be supported by a performance check procedure.

Table 2-1. Frequency related characteristics.

Characteristic	Performance Requirement	Supplemental Information
Frequency		
Range	9 kHz to 1.8 GHz	Tuned by the FREQ/ MKRS knob, FREQUENCY arrow keys, or set via the front-panel keypad or Utility Menu.
Accuracy	5×10^{-7} of center frequency ± 10 Hz ± 1 least significant digit	Assume zero drift since last normalization procedure.
Long Term Drift		2 PPM/Year.
Short Term Drift	< 400 Hz	Between correction cycles.
Readout Resolution		1 kHz or 1 Hz (counter readout) menu selectable.
Frequency Span/Div		
Range		From 100 MHz/div to 1 kHz/div in a 1-2-5 sequence, with the SPAN/DIV arrow keys, or set to arbitrary value via front-panel keypad or the Utility Menu; also 180 MHz/div in MAX SPAN and 0 Hz for ZERO SPAN,
Accuracy/Linearity	Within 3%	Measured over the center 8 divisions.
Flatness		
(About the midpoint between two extremes)	± 1.5 dB	Measured with 10 dB of RF Attenuation. Flatness affected by: input VSWR gain variation mixer conversion

Table 2-1 (Continued)

Characteristic	Performance Requirement	Supplemental Information
Residual FM		
SPAN/DIV \leq 20 kHz	\leq 100 Hz peak to peak total in 20 ms.	Short term, after 1 hr warm-up.
SPAN/DIV $>$ 20 kHz	\leq 2 kHz peak to peak total in 20 ms.	
Resolution Bandwidth		
Filter bandwidths measured 6 dB down		Standard selections: 300 Hz, 3 kHz, 30 kHz, 300 kHz, 5MHz Option 12 ¹ adds: 1 kHz, 1 MHz, and 200 Hz, 9 kHz, 120 kHz EMC filters Option 14 ¹ adds: 100 Hz, 1 kHz, 10 kHz, 100 kHz, 1 MHz
Shape Factor (60 dB/6 dB)	7:1 or less for all resolution BWs \leq 1MHz	
Noise Sidebands		
	\geq 70 dBc at 30 times resolution BW for all bandwidths \leq 100 kHz	
Video Filter		
		Twelve post-detection low-pass filters with nominal bandwidths of 3 Hz, 10 Hz, 30 Hz, 100 Hz, 300 Hz, 1 kHz, 3 kHz, 10 kHz, 30 kHz, 100 kHz, 300 kHz, and WIDE. See Table 6-2 for automatically-selected filter bandwidths in normal, EMC and QP modes. Filters can also be manually selected via the UTIL Menu.

¹ Options 04, 12, and 14 are mutually exclusive.

Table 2-2. Frequency/amplitude related characteristics.

Characteristic	Performance Requirement	Supplemental Information
Marker		Marker frequency & amplitude readouts displayed on screen preceded by "M". Use the FREQ/MKRS knob or the MKR ◀▶ keys to position the marker to any point on a digital sweep. Signal must be above threshold.
Accuracy		
Frequency		Same as Span/Div
Amplitude		Function of reference level, vertical scale, and normalizations. See display dynamic range in Table 2-3.
Delta Marker		
	When activated, a 2 nd marker appears. First marker remains stationary while the 2 nd is moveable.	Frequency and amplitude differences between markers are read out on screen preceded by "D". The FREQ/MKRS knob or the MKR ◀▶ keys position the moveable marker.
Accuracy		
Frequency	$1 \times 10^{-6} \pm 10 \text{ Hz}$	When both signals are counted.
Amplitude		Same as marker.
Center Measure		
		When activated, the signal nearest center screen (or nearest the marker if it is active) is moved to center screen and measured. The frequency and amplitude values, preceded by "C", are displayed on screen.
Readout resolution	1 kHz or 1 Hz	Menu selectable.
Signal Track		Continuously repeats the Center Measure function, thereby "tracking" a drifting signal. Signal must be above the threshold. If the signal decreases below the threshold level, the 2712 enters idle mode.

Table 2-3. Amplitude related characteristics.

Characteristics	Performance Requirement	Supplemental Information
Vertical DisplayMode		10 dB/Div, 5 dB/Div, 1 dB/Div and Linear.
Reference Level		Top graticule line.
Range		
Log Mode		-70 dBm to +20 dBm (-23 dBmV to +66.9 dBmV.)
Linear Mode		8.83 μ V/div to 280 mV/div.
Step size		
Log Mode		1 dB or 10 dB.
Linear Mode 10 dB step size		1-2-5 sequence between 10 μ V/div and 280 mV/div
1 dB step size		≥ 0.2 division per step.
Accuracy		Dependent on calibrator accuracy, normalization, and frequency response.
Display dynamic range		
Log	80 dB maximum	
Lin	8 divisions	
Accuracy		
10 dB/div mode	± 1.0 dB/10 dB to a maximum cumulative error of ± 2.0 dB over 70 dB range, and ± 4.0 dB cumulative over 80 dB range.	
5 dB/div mode	± 1.0 dB/10 dB to a maximum cumulative error of ± 2.0 dB over the 40 dB range.	
1 dB/div mode	± 1 dB maximum error over the 8 dB range.	
Linear mode	$\pm 5\%$ of full scale	
RF attenuator range		0 to 50 dB in 2 dB steps.

Table 2-3 (continued)

Characteristics	Performance Requirement	Supplemental Information
Sensitivity (without preamp)		
Resolution BW	Center Frequency 100 MHz 1.8 GHz	Equivalent maximum input noise for each res BW. NOTE: <i>Decrease in sensitivity is approximately linear from 100 MHz to 1.8 GHz.</i>
5 MHz	-85 dBm -77 dBm	
300 kHz	-97 dBm -89 dBm	
30 kHz	-107 dBm -99 dBm	
3 kHz	-117 dBm -109 dBm	
300 Hz	-127 dBm -119 dBm	
Sensitivity (with preamp)		<i>Start spur results in maximum 20 dB sensitivity loss from 10 MHz to 9 kHz.</i> <i>Sensitivity with preamp is not specified above 600 MHz.</i>
5 MHz	-97 dBm	
300 kHz	-109 dBm	
30 kHz	-119 dBm	
3 kHz	-129 dBm	
300 Hz	-139 dBm	
Spurious Responses		
Residual (no input signal)	-100 dBm or less except at 1780 MHz where the residual is -90 dBm or less	With 0 dB RF attenuation.
Intermodulation products (3 rd order)	-70 dBc or less	From any two on-screen signals within any frequency span.
Zero frequency spur	-10 dBm or less	Reference to input with 0 dB RF attenuation.
2nd harmonic distortion	-66 dBc or less	Measured with 1 st mixer input level \leq -40 dBm.
L.O. emission	-70 dBm or less	With 0 dB RF attenuation.

Table 2-4. Input/output signal characteristics.

Characteristic	Performance Requirement	Supplemental Information
RF Input		Type N 50 Ω female connector.
VSWR (RF atten \geq 10 dB)	1.5:1 maximum	
VSWR (0 dB RF atten)	3.0:1 maximum	
Maximum safe input		20 dBm (0.1 W or 2.2 V) and 100 VDC continuous. DO NOT EXCEED MAXIMUM INPUT RATINGS
1 dB compression point	-15 dBm minimum at first mixer input	First mixer optimum input level must be set to -30 dBm ((INPUT)/[4]).
Ext trig (J102)		BNC connector, 10 k Ω impedance, DC coupled for external trigger signals.
Amplitude		
Minimum		Typically 100 mV, 15 Hz to 1 MHz.
Maximum		50V (DC + peak AC).
Pulse Width		0.1 μ s minimum.
Accessory conn. (J103)		DB-9 female connector.
Pin 1: External Video Input		Typically 100 Ω , DC coupled, 0- 1.6V (200mV/ Div), 0-50kHz input signal for vertical deflection of the crt beam. Signal is processed by the digital storage circuits (which can be turned off) and the 1, 5, and 10 dB scale factor circuits. Also used as the Model 1405 marker input.
Pin 2: Ground		Chassis and signal.

Table 2-4 (continued)



Characteristic	Performance Requirement	Supplemental Information
(J103) – continued		
Pin 3: Video Output		Provides 0-1.6 V video signal proportional to the vertical display height. 0 V is the top of the screen. Impedance is 1 k Ω .
Pin 6: Sweep Gate		TTL-compatible signal that goes to a logic high level while the CRT beam is sweeping.
Pin 7: Sweep Output		Provides a nominal +1.3 V to -1.3 V negative going ramp, proportional to the horizontal sweep position. Output impedance < 50 Ω .
Pins 4, 5, 8, and 9		Not used.
Standard Digital Communications Port (J104)	Conforms to IEEE Standard 488-1978	24-pin back-panel connector. See Table 2-7 for optional serial port information.

Table 2-5. Power requirements.

Characteristic	Performance Requirement	Supplemental Information
Input voltage		
Line voltage range	90 to 250 VAC	
Line frequency range	48 to 63 Hz	
Line voltage range	90 to 132 VAC	
Line frequency range	48 to 440 Hz	
Line fuse	2 A slow-blow	
Input power	90 W (1.2 A) for standard instrument 105 W (1.4 A) maximum with options	At 115 V, and 60 Hz.
Leakage current		3.5 mA rms maximum or 5 mA peak maximum.

Table 2-6. General characteristics.

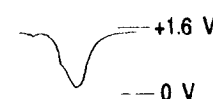
Characteristic	Performance Requirement	Supplemental Information
Sweep		Normal, Manual Scan, Single Sweep, and Video Monitor (Option 10).
Sweep Rate	1 μ s/Div to 2 sec/Div in a 1-2-5 sequence	
Accuracy	$\pm 10\%$ over the center 8 divisions	
Triggering		Free run, internal, external, line, TV line, and TV field.
Internal or external trigger level	Signal height ≥ 1 division	See Ext Trig in Table 2-4.
Internal Calibrator		
Amplitude	-30 dBm ± 0.3 dB	Provides 100 MHz fundamental and harmonic comb.
Frequency	100 MHz ± 2 kHz	
Drift	± 2 PPM/Year	
Real Time Clock		
Oscillator Frequency Stability	32.768 kHz ± 50 ppm	
Drift	± 5 ppm/year	
Non-Volatile Memory (Battery backed-up)		Instrument settings, waveforms, and some normalization results are stored in NVRAM.
Battery Type		Lithium cells
Battery Life: At +55° C		1 to 2 years.
At + 25° C		At least 5 years.
Temperature Range for Data Retention		-10° C to + 75° C.

WARNING

Handling and disposing of lithium cells can be hazardous. Refer all battery maintenance to a Tektronix service center.

Table 2-7. Electrical characteristics of instrument options.

NOTE: Options 04, 12, and 14 are mutually exclusive.

Characteristic	Performance Requirement	Supplemental Information
Option 04		Tracking Generator.
Frequency		Tracks spectrum analyzer.
Range TG tracking (offset)	100 kHz to 1.8 GHz Sufficient to align TG in analyzer bandpass	Typically -5 kHz to +60 kHz.
Output level		
Range Accuracy	-48 dBm to 0 dBm ± 1.5 dB	0.1dB steps. At 100 MHz.
Output impedance VSWR	2:1 or better when output level ≤ -8 dBm	50 Ω nominal
Flatness		
Tracking generator	± 1.0 dB 100 kHz-1.8 GHz ± 1.5 dB to 1.8 GHz	Typically ± 1 dB to 1.8 GHz
TG/2712 combination	± 2.5 dB 100 kHz-1.0 GHz ± 3.0 dB to 1.8 GHz	With 10 dB RF attenuation in analyzer
User-corrected	± 0.2 dB	Using B,C MINUS SAVE A
System dynamic range	>100 dB	Sensitivity ≥ -100 dBm
System residual FM		≤ 100 Hz _{p-p} total in 20 ms
Spurious signals		
Harmonic	-20 dBc or better with respect to fundamental	At frequencies ≥ 100 kHz
Non-harmonic	-35 dBc or better with respect to fundamental	
Option 08	Conforms to EIA Standard RS-232(D).	RS-232 serial port substitution for standard GPIB port (both ports cannot be installed in 2712 simultaneously). Male DB9 connector.
Option 10		Video monitor capability

Table 2-7 (continued)

Characteristic	Performance Requirement	Supplemental Information
Option 12		Quasi-peak detector and additional RBW filters.
Resolution BW		Adds 1 MHz, 120 kHz (EMC), 9 kHz (EMC), and 1 kHz filters; substitutes 200 Hz (EMC) filter for the standard 300 Hz . (6 dB nominal BW)
Shape factor (60 dB/6 dB)	7:1 or less	
Sensitivity (without preamp)		Equivalent maximum input noise for each res BW.
Resolution BW	Center Frequency 100 MHz 1.8 GHz	
200 Hz	-128 dBm -120 dBm	NOTE: <i>Decrease in sensitivity is approximately linear from 100 MHz to 1.8 GHz.</i>
1 kHz	-122 dBm -114 dBm	
9 kHz	-112 dBm -104 dBm	
120 kHz	-101 dBm -93 dBm	
1 MHz	-92 dBm -84 dBm	
Sensitivity (with preamp)		Start spur results in maximum 20 dB sensitivity loss from 10 MHz to 9 kHz.
200 Hz	-140 dBm	
1 kHz	-134 dBm	
9 kHz	-124 dBm	<i>Sensitivity with preamp is not specified above 600 MHz.</i>
120 kHz	-113 dBm	
1 MHz	-104 dBm	
EMC Mode Display Dynamic Range	40 dB maximum (Log) 8 divisions (Lin)	
Accuracy 5 dB/div	±1 dB/10 dB to a maximum cumulative error of ±2 dB over first 35 dB. ±2 dB total from 35 to 40 dB.	
1 dB/div	±1 dB maximum over the 8 dB range.	
Linear	±5% of full scale	

Table 2-7 (continued)

Characteristic	Performance Requirement	Supplemental Information
Option 14		Additional resolution BW filters.
Resolution BW		Adds 1 MHz, 100 kHz, 10 kHz, and 1 kHz filters. (6 dB nominal BW)
Shape factor (60 dB/6 dB)	7:1 or less	
Sensitivity (without preamp)		Equivalent maximum input noise for each res BW.
Resolution BW	Center Frequency 100 MHz 1.8G Hz	NOTE: <i>Decrease in sensitivity is approximately linear from 100 MHz to 1.8 GHz.</i>
1 MHz	-92 dBm -84 dBm	
100 kHz	-102 dBm -94 dBm	
10 kHz	-112 dBm -104 dBm	
1 kHz	-122 dBm -114 dBm	
Sensitivity (with preamp)		<i>Start spur results in maximum 20 dB sensitivity loss from 10 MHz to 9 kHz.</i>
1 MHz	-104 dBm	
100 kHz	-114 dBm	
10 kHz	-124 dBm	
1 kHz	-134 dBm	
Option 15		
1 st L.O. output level	≥0 dBm	

ENVIRONMENTAL SPECIFICATIONS

The environmental characteristics of the 2712 Spectrum Analyzer are listed below. A brief description of each characteristic and how it was obtained is provided. The 2712 meets MIL T-28800E, type III, class 5, style C specifications.

Table 2-8. Environmental characteristics.

Characteristic	Description
Temperature	
Operating and humidity	0° C to +50° C MIL T-28800E 5 cycles (120 hours).
Non-operating ²	-55° C to +75° C.
Altitude	
Operating	15,000 ft.
Non-operating	50,000 ft.
Humidity	
Non-operating	Five cycles (120 hours) in accordance with MIL-Std-28800E, class 5.
Vibration	
Operating (Instrument secured to a vibration platform during test)	MIL-Std-28800E, Method 514 Procedure X (modified). 15 minutes along each of 3 major axes at a total displacement of 0.015 inch peak-to-peak (2.4 g at 55 Hz), with frequency varied from 10 Hz to 55 Hz in 1-minute sweeps. Hold for 10 minutes at 55 Hz. All major resonances must be above 55 Hz.
Shock	
(Operating and Non-operating)	Three guillotine-type shocks of 30 g, one-half sine, 11 ms duration each direction along each major axis; total of 18 shocks.
Transit Drop	
(free fall)	8 inch, one per each of six faces and eight corners (instrument is tested and meets drop height of 12 inches).

² After storage at temperatures below -15° C, the instrument may not reset when power is first turned on. If this happens, allow the instrument to warm up for at least 15 minutes, then turn POWER OFF for 5 seconds and back ON.

PHYSICAL SPECIFICATIONS

Table 2-9 lists the weight and dimensions of the 2712 Spectrum Analyzer.

Table 2-9. Physical characteristics.

Characteristic	Description
Weight	<11.25 kg (25 lbs) maximum, including standard accessories. <10.2 kg (22.5 lbs) nominal for basic model
Dimensions	
Height with feet and handle	137 mm (5.4 in)
Width (with handle)	361 mm (14.2 in)
(without handle)	328 mm (12.9 in)
Depth (with front panel cover)	445 mm (17.5 in)
(without front panel cover)	428 mm (16.85 in)
(with handle extended)	511 mm (20.1 in)

Table 2–10: Certifications and compliances.

Characteristics	Description
<p>EC Declaration of Conformity – EMC</p>	<p>Meets intent of Directive 89/336/EEC for Electromagnetic Compatibility. Compliance was demonstrated to the following specifications as listed in the Official Journal of the European Communities:</p> <p>EN 50081-1 Emissions:</p> <p style="padding-left: 40px;">EN 55022 Class B Radiated and Conducted Emissions</p> <p style="padding-left: 40px;">EN 60555-2 AC Power Line Harmonic Emissions</p> <p>EN 50082-1 Immunity:</p> <p style="padding-left: 40px;">IEC 801-2 Electrostatic Discharge Immunity</p> <p style="padding-left: 40px;">IEC 801-3 RF Electromagnetic Field Immunity</p> <p style="padding-left: 40px;">IEC 801-4 Electrical Fast Transient/Burst Immunity</p> <p style="padding-left: 40px;">IEC 801-5 Power Line Surge Immunity</p>
<p>EC Declaration of Conformity – Low Voltage</p>	<p>Compliance was demonstrated to the following specification as listed in the Official Journal of the European Communities:</p> <p style="padding-left: 40px;">Low Voltage Directive 73/23/EEC</p> <p>EN 61010-1:1993</p> <p style="padding-left: 40px;">Safety requirements for electrical equipment for measurement, control, and laboratory use</p>
<p>Approvals</p>	<p>UL1244 – Standard for Electrical and Electronic Measuring and Test Equipment</p> <p>CAN/CSA C22.2 No. 231 – Safety requirements for Electrical and Electronic Measuring and Test Equipment</p>

Table 2–11: Safety standards.

Category	Standards
U.S. Nationally Recognized Testing Laboratory Listing	UL1244 – Standard for Electrical and Electronic Measuring and Testing Equipment
Canadian Certification	CAN/CSA C22.2 No. 231 – Safety Requirements for Electrical and Electronic Measuring and Test Equipment
European Union Compliance	Low Voltage Directive 73/23/EEC, as Amended by 93/68/EEC EN 61010-1 Safety Requirements for Electrical Equipment for Measurement, Control, and Laboratory Use
Additional Compliance	UL3111-1 – Standard for Electrical Measuring and Test Equipment IEC1010-1 – Safety Requirements for Electrical Equipment for Measurement, Control, and Laboratory Use

Table 2–12: Safety certification compliance.

Category	Description
Temperature (operating)	+5° to +50° C
Altitude (maximum operating)	2000 meters (6562 ft.)
Relative Humidity (maximum operating)	80% for temperatures up to 31° C, decreasing linearly to 50% at 40° C
Equipment Type	Test and Measuring
Safety Class	Class I (as defined in IEC 1010-1, Annex H)-grounded product
Overvoltage Category	Overvoltage Category II (as defined in IEC 1010-1, Annex J)
Pollution Degree	Pollution Degree 2 (as defined in IEC 1010-1) Note: Rated for indoor use only

SECTION
3

GETTING
ACQUAINTED

SECTION 3

GETTING ACQUAINTED WITH YOUR INSTRUMENT

This section describes the procedure you should follow when your new Spectrum Analyzer arrives from the factory. To prevent damage to the instrument during initial check out and subsequent use, be sure to observe the indicated precautions.

RECEIVING AND UNPACKING

The 2712 Spectrum Analyzer and its standard accessories are carefully packed at the factory using a specially designed shipping container to prevent damage during transit.

If, upon receipt, damage to the shipping container was evident, notify the shipper. Tektronix is not responsible for damage caused during shipping.

If you have not already done so, carefully remove the analyzer and its accessories from the shipping container and inspect them for damage. Do not destroy the shipping container. Test analyzer operation using the procedure in *System Checkout* later in this section. If damage or defects are discovered, or if components are missing, notify your Tektronix representative. He or she will instruct you on how to proceed.

REPACKAGING AND STORING

In the event that the equipment must be returned to a Tektronix Service Center, carefully repackage it in the original shipping container. Use the vinyl vapor barrier, and insert the original foam blocks in the same fashion they were received. If the original shipping materials are not available, use a container of equivalent strength and dimensions. Wrap the instrument in a vinyl vapor barrier, and cushion the instrument on all sides with foam or other suitable packing material.

Attach a tag to the instrument clearly showing:

- owner's name and address
- name of the person at your location who may be contacted
- instrument model and serial number
- description of the problem and service expected

The 2712 can be stored up to 90 days in an environment that meets the non-operating specifications. It is suggested that you provide a dust cover. For longer periods, the instrument should be enclosed in a vapor barrier containing appropriate desiccant material and stored in an environment that meets the non-operating specifications. The original shipping material can be used, and is also useful for protecting the equipment if it must be moved.

INSTALLATION

The 2712 is designed for table-top operation in any orientation, and requires no special installation. However, the handle can be positioned at several angles to serve as a convenient tilt stand. To position the handle, pull out at both pivot points on the sides of the instrument, and simultaneously rotate the handle to the desired position.

Tektronix also provides an optional 2712 rackmount adapter kit (Option 30) which requires 5¼ inch vertical clearance and a "cradle mount" adapter (Option 34) which requires 7 inches. Contact your Tektronix representative for additional information.

The 2712 is equipped with a plastic front panel cover to protect it from mechanical damage. The cover should always be used when transporting the Analyzer. To remove the cover, place the instrument on its back feet, and then simultaneously pull out and up slightly on each side of the cover.

Regardless of where the 2712 is used or installed, always provide at least two inches (2") clearance adjacent to the cooling vents at the sides, bottom, and back of the analyzer.

See section 2, *Specifications*, for input power requirements.

PRECAUTIONS

The 2712 is tough but not indestructible. It can be damaged by:

- applying too large a signal to the input
- applying incorrect mains power
- allowing moisture, dust, or other contaminants inside the case
- handling the analyzer with undue roughness
- not providing proper ventilation

Never apply signals to the 2712 input if their combined amplitude is greater than +20 dBm, or if there is a DC component greater than 100 volts. *If you exceed these maximum input ratings, you can permanently damage the analyzer.*

If necessary, use an external attenuator first. Further, to prevent damaging transients, use maximum RF attenuation when connecting a signal with a DC component. Then remove attenuation as needed to make the measurement. Also be aware that the 2712 is optimized for a -30 dBm input to the first mixer. A larger input signal may lead to nonlinear operation and inaccurate results.

DO NOT connect the 2712 directly to a CATV trunk carrying AC power. The mixer can be overloaded making accurate measurements impossible, and a surge in the power might place the peak AC voltage above the level tolerable by the analyzer.

NOTE

The maximum safe RF and DC input levels are clearly printed near the signal input jack.

The 2712 will accept mains power up to 250 VAC rms (see section 2 for additional information). In the normal laboratory or factory environment, using standard plugs and receptacles, it is unlikely that you will apply incorrect power. However, in the field or during abnormal conditions, you might have to rig temporary power. Be certain that any power source connected to the 2712 applies less than 250 VAC rms between conductors or between either conductor and ground. To safeguard the source, ensure that it is rated for at least 120 Watt operation.

Electronic circuits do not mix well with water, chemicals, dust, or grit. Avoid exposing your instrument to these or other contaminants; the case is not water- or air-tight. Do not place liquid containers on or near the analyzer where they can be spilled into it. Use the Travel Line rain cover (Option 33), or other suitable covering, when transporting the 2712 out of doors in inclement weather.

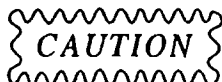

Although the 2712 can be operated in any orientation, you must ensure that the clearance provided by the feet is maintained on the bottom and that there are at least two inches clearance around other sides. DO NOT block the air intake areas on the sides or bottom of the 2712 or the exhaust area at the rear. Never run the instrument inside a case.

Do not physically abuse the 2712. It can withstand a fair amount of rough handling but dropping it off a workbench or bouncing it around the trunk of a car or the back of a truck may cause damage. Protect the instrument while transporting it and use it where it cannot be accidentally hit, kicked, or dropped.

SYSTEM CHECKOUT

After you have observed the foregoing precautions, you are ready to perform the initial system checkout. Checkout consists of "normalizing" the 2712 and then measuring the frequency and amplitude of the built-in calibration source. In the process, you will become acquainted with the front panel and the display.

Turning On the 2712

Make sure there is no signal source connected to the analyzer and plug in the power cord. Then press the POWER switch.

The green LED adjacent to the power switch lights indicating that power is turned on. The LED indicators flash and you hear a few beeps as the analyzer performs its power-up self test.

When power is applied to the 2712, it initializes its front-panel controls to settings stored in memory. If the instrument has been used before, those settings may be user-defined (see *User-Defined Power-up Settings* in section 6). If no user-defined settings exist, the 2712 defaults to the factory power-up settings which are permanently stored in read-only memory (ROM).

A display appears on screen almost immediately. You may see the messages:

**STAND BY
WARMUP TIME 15 MIN**

When the factory-default power-up settings are being used, the **STAND BY** message does not appear and it is possible to make general observations immediately after the power is turned on. If user-defined power-up settings are implemented, the **STAND BY** message appears briefly. The 2712 front panel is locked out while the message is displayed. After the message disappears, the factory default settings are replaced by the user-defined settings, and you can proceed with your observations.

Whichever settings are used, the **WARMUP** message is displayed. It disappears after a few seconds. Remember, however, that the analyzer may require a full 15 minutes to be operating within specification. Consequently, measurement errors and system messages can occur within the warm-up period, particularly if you switch the 2712 to a narrow span or resolution BW filter.

Initial Normalization

You may also see the following phrase during warmup:

NORMALIZATION SUGGESTED

Normalization is a process by which the 2712 measures and stores its own calibration parameters using a built-in reference. When this message appears, the instrument is reporting that its self-test feature has determined that the performance of the 2712 no longer matches that predicted by the previous normalization. It is not unusual for the message to appear during the warm-up period, especially if a narrow resolution bandwidth filter is called for by user-defined power-up settings, or if the ambient temperature is different than that at which the previous normalization was performed. If the message remains (or reappears) after the warm-up period, a new normalization should be carried out. Normalization ensures the utmost accuracy when making measurements. It is suggested that, whenever maximum accuracy is required, you allow your instrument to reach a stable operating temperature in the environment in which the measurements will be carried out, and then perform a normalization before making the measurements.

You will now perform a normalization to ensure the calibration of the 2712, and to verify its operational status. Here, we will simply tell you how to do it, but additional information about normalization may be found in section 6 under *Normalizing the 2712*.

To normalize the 2712, ensure that all external signals are disconnected from the analyzer, and then press:

UTIL

Pressing the [UTIL] and [3] keys calls up a menu which offers you a choice of normalization processes.

Select **ALL PARAMETERS**¹ by pressing:

¹ Does not include the optional tracking generator (Option 04).

Normalization should begin immediately and continue without interruption until it is completed. Normalizing all parameters requires several minutes. During the process, you will see various displays and messages which keep you informed of progress, but do not require action. The process ends with an audible beep and the:

NORMALIZATION COMPLETE

message indicating satisfactory operation. **If you receive any other message terminating this initial normalization, repeat the procedure. If the message persists, contact your Tektronix Service Center.**

Restoring the Factory Default Settings

To ensure a uniform starting point for the calibration signal measurement, restore the factory-default power-on settings by pressing:

UTIL

	1	1
--	---	---

Pressing **[UTIL][1][1]** restores the factory-default settings whenever the 2712 is in normal spectral display mode (and most other modes). It is a handy method of returning to a fixed set of conditions if you get lost.

The factory defaults set the reference level and span to maximum. With the reference level at maximum, the incoming signal undergoes maximum RF attenuation. This is a safeguard designed to prevent overloading the first mixer stage of the analyzer. The span is set to maximum so that you observe the entire input frequency range of the 2712. This prevents you from overlooking a large off-screen signal which might overload the input or the first mixer. We urge you to use these settings whenever you input a new or unknown signal to the analyzer.

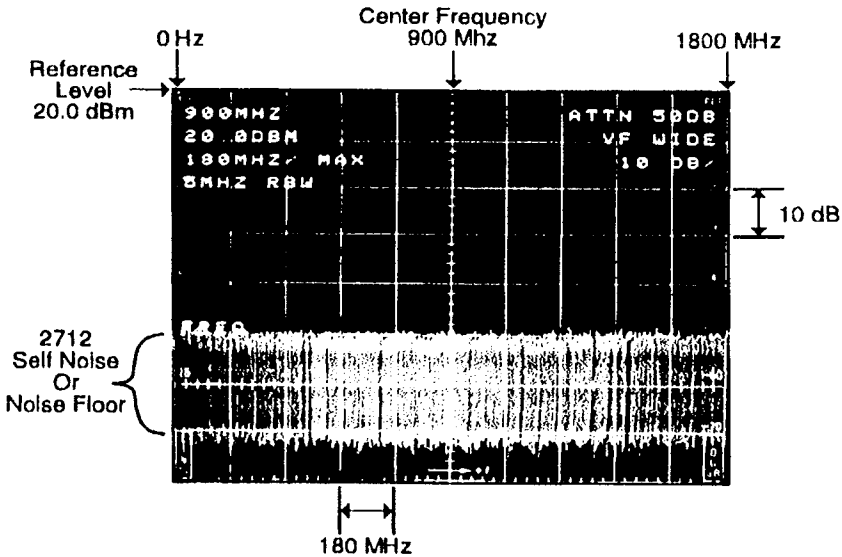

Figure 3-1. 2712 display with factory power-up settings.

The Initial Display

Figure 3-1 shows what the 2712 screen looks like with the factory power-up settings implemented. The displayed spectrum represents the *noise floor* of the 2712. The noise floor is the amplitude of the noise generated internally by the analyzer itself and passed through the resolution BW filter. Narrowing the resolution BW lowers the noise floor because noise power is proportional to the resolution bandwidth.

The noise appears as a thick, irregular band across the bottom half of the screen. To achieve this appearance, digital display storage is used. The unique *max/min* display shown here is designed to resemble the analog spectra which the 2712 inherently produces.

To see the analog display, press:

D

Center frequency	RF attenuation
Reference level	video filter bandwidth
Horizontal scale factor	vertical scale factor
Resolution bandwidth	
Various messages may appear as needed below the data readout columns	

Figure 3-2. Normal on-screen data readouts.

This turns off the 2712's D storage register (the only one currently enabled). When all registers are turned off, the analog display appears. **Toggle the D-register on and off several times by repeatedly pressing [D], and notice the similarity between displays. Then leave the D-register turned on.**

To obtain the max/min display, the maximum and minimum amplitudes of the analog spectrum are each sampled at 256 points. Plotting the two interleaved sets of 256 points produces the 512 point graph of the spectrum that you see. This display not only imitates the analog spectrum, but can also assist in detecting low level signals by more effectively showing the characteristic void they produce under the noise floor.

The spectral display is overlaid by a 32-character wide by 16-character high text screen. Not all of the text fields are displayed all the time, and you can turn the text screen on and off by pressing [READOUT].

The top half of the text screen contains two data readout columns which are present whenever the text screen is turned on. The readouts show analyzer settings or measurement results. Figure 3-2 shows the data normally displayed in the readout columns.

You can optionally display starting frequency (frequency at the left edge of the display) at the top of the left column instead of center frequency.

If the analyzer is placed in **MAX SPAN** mode as it is now, the resulting spectrum spans the entire input frequency range. In

this mode (indicated by **MAX** following the horizontal scale factor), the first item in the left column lists the frequency at the location of the *marker* (the intensified spot on the display).

The types of information in the right column may change depending on operating mode. You will learn when to expect alternate information as we discuss the various modes.

Below the readout columns, messages and indicators appear as warranted, and numeric instrument settings can be entered.

Control Panel Basics



The 2712 control panel possesses several characteristics which make it easy and convenient to operate:

- Controls with related functions are generally grouped together. The groupings are defined by the borders or background color surrounding the controls. We shall refer to the groupings as *function blocks*.
- *Dedicated function keys* permit quick selection of important measurement functions.
- *Arrow keys* directly increase and decrease critical control settings.
- *Menu keys* located in the **MENUS** function block *call up* lists of operator-selectable 2712 features.
- Numeric *keypad keys* permit selection of menu options and entering of critical measurement parameters.
- *Terminator keys* in the keypad block designate the correct units for numeric entries with a single keystroke.
- An *immediate entry mode* which enables you to enter arbitrary values for the frequency, span, and reference level directly from the keypad.
- Red LED *function status indicators* adjacent to certain keys indicate when the functions are active.
- Green LED *register status indicators* illuminate when any storage register contains a saved waveform.

If desired, spectrum measurements can be carried out using only the front-panel dedicated function keys; you don't have to use menus. Notice especially that the controls most fundamental

to spectrum measurements (FREQUENCY, SPAN/DIV, and REF LEVEL) are located in a single central function block with a darker gray background. These controls can be conveniently set using either the arrow keys or immediate entry mode.

The arrow keys enable you to instantly change control settings.

 always increases its related parameter, whereas  always decreases it. The arrow keys are active whenever the analyzer is in spectral display mode.

In immediate entry mode, you press the key corresponding to the parameter you wish to set (FREQUENCY, SPAN/DIV, or REF LEVEL), type the parameter value on the keypad, and press the appropriate terminator key to complete the entry. The value appears on screen as you type.

Each of the terminator keys ([W], [X], [Y], [Z]) can represent more than one unit as indicated by the legend to the right of each key. However, the keys are context sensitive: if an entry represents a frequency, the indicated frequency unit is selected automatically when you press the key; if dBs are required, the indicated dB unit is selected; and so on for all of the units.

One other noteworthy feature: many keys are toggle-action. The ability to undo an action, including menu selection, by pushing the same button, or sequence of buttons, that carried out the action is typical of operations performed on the 2712.

To observe the toggle action, press:

VID FLTR



The red video filter LED illuminates, and the trace shrinks vertically as the filter turns on and averages the noise.

Press **[VID FLTR]** again.

The noise spectrum expands to its original size as the filter is turned off, and the LED goes out.

Sounds

The 2712 can emit tones under the following conditions:

- during power-on self test
- when an abnormal condition occurs
- when a message appears
- when a key is pressed

You heard the self test beeps when you turned on the 2712. The beep can be set to sound when an error occurs, when a key is pressed, when either happens, or never.

If an abnormal condition exists, such as a request to extend a measurement parameter beyond its range, the 2712 emits the high-level beep. A message is simultaneously displayed on screen describing the abnormal condition.

The 2712 can also emit more interesting sounds. It is equipped with AM and FM demodulator circuits which extract the audio signals on amplitude or frequency modulated RF signals. The demodulated audio is reproduced on the built-in speaker. This feature can be used to identify most voice channels based on their content or call signs, and can help to identify others by enabling you to determine the type of modulation (frequency shift keying, pulsed CW, etc.). For better quality audio or private listening, use the headphone jack on the right side of the analyzer. The AM/FM demodulators are covered in the discussion of the DEMOD/TG Menu in section 6.

The Built-In Calibrator

The 2712 is equipped with a built-in calibration source. The calibrator for the 2712 is a bit different from others you've encountered in that there is no external "Cal Signal" output. Instead, the calibrator is tucked securely inside the analyzer and "connected" to the input of the 2712 without the need for external cabling (and attendant mismatches) by selecting the proper Input Menu option.

To call up the Input Menu, press:

INPUT



Item 9 specifies a CAL SIG @ 100MHz -30dBm. The calibrator emits a CW signal with a fundamental frequency of 100 MHz \pm 2 kHz at an amplitude of -30 \pm 0.3 dBm. Higher order harmonics at lower levels are also present. Item 9 toggles the calibrator on and off.

Turn the calibrator on by pressing:

9

The screen reverts immediately to the spectral display. The word CALIBRATOR now appears near the bottom right of the screen signifying that the calibrator is turned on. You should see a few signal peaks towards the left of the display. These are the calibration signal's fundamental and harmonics. If you don't see them, your eyes are probably not going bad; the amplitudes of the harmonics may be lower than the 2712's noise floor

NOTE

When the calibrator is turned on, the normal RF input is disconnected internally from the input attenuator and cannot be viewed.

Turn the calibrator off by pressing:

[INPUT]/[9]

Making Your First Measurement

Let's begin by verifying the frequency and amplitude of the 2712's calibration signal. Although the calibration signal is used, the measurement technique is the same for any continuous signal. In the process, you will learn to use three of the most important controls on the analyzer, and to confirm that the major functions of the 2712 are operating correctly.



The factory defaults set the analyzer RF attenuation to 50 dB. This affords the most protection to the analyzer because any

signal at the input undergoes maximum attenuation before reaching the power-sensitive mixer circuit. It is recommended that you use this setting when connecting unknown signals to the 2712. The span is set to 180 MHz per division. This is maximum span, and is indicated by the word **MAX** in the span readout. This is the safe setting for introducing new signals. It enables you to view the entire measurement range (1.8 GHz) of the analyzer. If a smaller span is used, large signals can be present off screen. Remember -- the *total signal power* (that is, all signals on screen or off added together), not just the signal of interest, must remain below +20 dBm. With a small span it is also possible to reduce the attenuation to view a low level, on-screen signal while inadvertently allowing an off-screen high-level signal to saturate the mixer, causing spurious responses and possibly even damaging the mixer.

Turn on the built-in calibrator via the Input Menu.

In order to measure the calibration signal, you are going to use the three primary controls on the analyzer. These are contained in the central darker gray function block shown in Figure 3-3.

These, and the large **FREQ/MKRS** knob to the left, are the controls you will use most often. In principal, you can make nearly all measurements with only these controls, although you will find that other 2712 controls and menu features enable you to make many measurements more quickly and conveniently.

First, you need to raise the displayed signal height. You do this by reducing the reference level. The reference level represents the signal power needed to deflect the displayed spectrum to the top graticule line. The 2712 provides several methods of directly changing reference level. The most convenient method is to press the   keys.

Reduce the reference level 30 dB by pressing the  key to the right of [REF LEVEL] three times. Figure 3-4 shows what the resulting display should look like. Don't be concerned if some of the signal peaks on your analyzer have slightly different amplitudes than those shown.

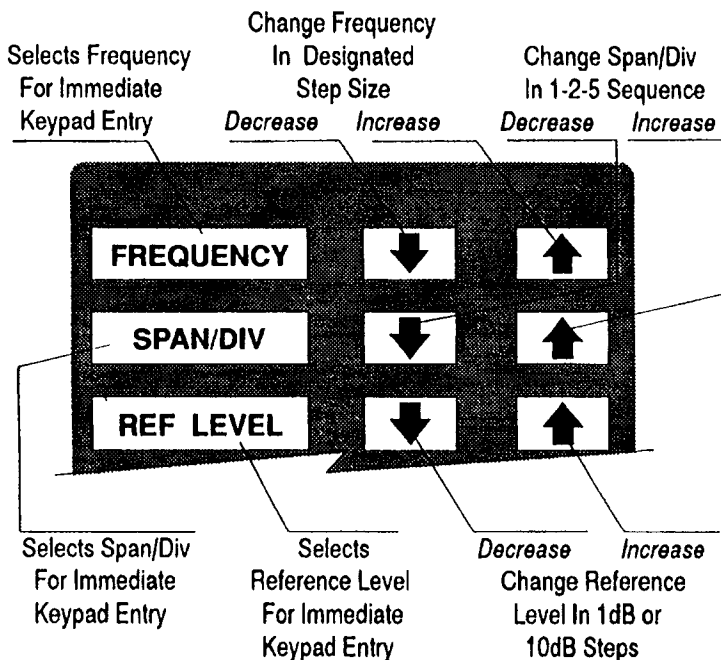

Figure 3-3. The 2712 primary controls.

Notice that both the reference level and RF attenuation readouts have decreased 30 dB (the reference level is -10 dBm and the RF attenuation is 20 dB).

Normally the arrow keys change the reference level 10 dB per press, but in FINE mode the value changes 1 dB per press.

Let's now use another method to set the reference level to -28 dBm, less than half a division above the expected signal amplitude. We choose this value for two reasons:

- Signal amplitudes are read out and displayed most accurately when they are near the reference level.
- 2 dB provides a small amount of "headroom" in case the signal should be slightly larger than anticipated.

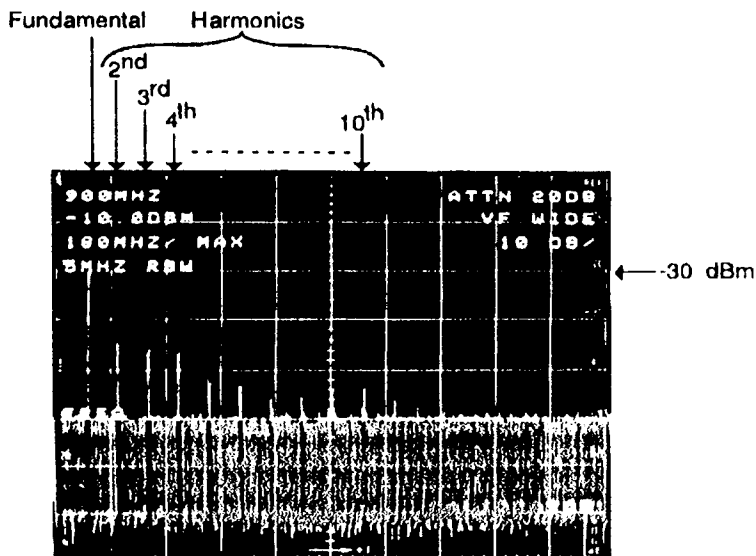

Figure 3-4. 2712 calibration signal and harmonics.

To specify a pre-determined value, first press [REF LEVEL] to place reference level in immediate entry mode. The abbreviation REFL will appear at left center of the 2712 screen.

The REFL indicator tells you that you can enter the reference level directly from the keypad. This is done by typing a permissible value followed by an appropriate terminator key.

NOTE

In spectral display mode the abbreviation for the control last placed in immediate entry mode remains on screen until another control is chosen. When a control is in immediate entry mode, repeated settings for that control can be entered without having to press FREQUENCY, SPAN/DIV or REF LEVEL again. Only the primary controls can be placed in immediate entry mode.

Set the reference level to **-28 dBm** by pressing **[2]/[8]**. The numbers you type appear on screen to the right of **REFL**. If you make a mistake, you can correct it by repeatedly pressing **[BKSP]** (the backspace key) until the incorrect number disappears, and then entering the correct value.

After the correct number has been entered, press [-dBx]. This key can represent units of Hz or -dBx. Because you selected an entry mode (immediate reference level entry) which requires decibels, and because the factory-default unit is the dBm, the 2712 correctly interprets the currently displayed entry as -28 dBm. If the currently selected reference level units had been dBmV or dBW, the 2712 would have interpreted your entry as such when you pressed the terminator key.

The RF attenuation is reduced to 2 dB and the reference level readout indicates the desired -28 dBm. This entry method enabled you to specify a reference level which couldn't be achieved with the arrow keys unless you switched to **FINE** mode. You can even enter fractional reference levels to the nearest 0.1 dB with this method.

The analyzer is still in max span mode, which means that the harmonics of the calibration signal are barely more than one half division apart. Let's spread them out by reducing the span/division. As in the case of the reference level, the 2712 provides two direct methods.

Reduce the span to 50 MHz/division by pressing the  key to the right of **[SPAN/DIV]** twice. Notice that the readout now indicates **50MHZ/**, and the harmonics are two divisions apart.

Let's suppose, however, that you want to view just a single harmonic and the 30 MHz band to either side of it. You can do so by setting the span to 6MHz/division. This is not a value obtainable with the arrow keys, but you can specify it in immediate entry mode.

To set the span/division to a predetermined value, first press [SPAN/DIV] to place span in immediate entry mode.

Notice that the abbreviation SPAN appears at left center of the 2712 screen.



The SPAN indicator tells you that you can enter the span/div directly from the keypad. This is done by typing in a permissible value followed by an appropriate terminator key.

To set the span/division to 6 MHz, press [6]. Any number you type appears on screen to the right of SPAN. If you make a mistake, you can correct it by repeatedly pressing [BKSP] (the backspace key) until the incorrect number disappears, and then entering the correct value.

After the correct number has been entered, press [MHz]. This key can represent units of MHz, mSEC, or mV. Because you selected an entry mode which requires a frequency, the 2712 correctly interprets the currently displayed entry as 6 MHz. If a time or voltage unit had been required, the 2712 would have interpreted your entry as 6 mSEC or 6 mV, respectively.

The span is now set to 6 MHz/ and the ninth harmonic of the calibration signal is centered on screen at 900MHz. You may have noticed that the resolution BW changed to 300KHZ (1MHz if Option 12 or 14 is installed). This demonstrates the AUTO resolution BW selection mode of the 2712. The analyzer reduces its resolution BW as you reduce the span/div, so the resolving power of the instrument automatically increases as you look at the spectrum more closely.

To look at the calibration signal fundamental, you must change the center frequency. The 2712 provides three direct methods of doing so, each appropriate under different circumstances.

Press the  key to the right of [FREQUENCY] twice. Notice that the center frequency readout now indicates 888.0MHz. The frequency arrow keys change the center or start frequency by 10 times the automatically selected tuning increment, but you can change the tuning rate – see *Selecting the Tuning Increment* in section 6. You could continue pressing  until the correct frequency is reached, but this would require a large number of presses.

This method of changing frequency is very useful for scanning relatively small bands. To change by larger amounts, let's use the immediate entry mode.

To set the center or start frequency to a predetermined value, press [FREQUENCY] to place the center or start frequency in immediate entry mode. Notice that the abbreviation FREQ appears at left center of the 2712 screen.

The FREQ indicator tells you that you can enter the center frequency directly from the keypad. This is done by typing in a permissible value followed by an appropriate terminator key.

Set the center frequency to 101 MHz by pressing [1][0][1]. The numbers you type appear on screen to the right of FREQ. If you make a mistake, you can correct it by repeatedly pressing [BKSP] (the backspace key) until the incorrect number disappears, and then entering the correct value.

After the correct number has been entered, press [MHz]. This key can represent units of MHz, mSEC, or mV. Because you selected an entry mode which requires a frequency, the 2712 correctly interprets the currently displayed entry as 101 MHz. If a time or voltage unit had been required, the 2712 would have interpreted your entry as 101 mSEC or 101 mV. Alternately, had you wished to set the frequency to 101 kHz, you would have pressed [kHz].

This method of changing center or start frequency is most useful when large changes are required, or if you know ahead of time exactly what frequency is required.

The span is now set to 6 MHz/ and the fundamental of the calibration signal is not quite centered on screen. You will now center the calibration signal with the FREQ/MKRS knob.

Reduce the center or start frequency by turning the large round knob in the FREQ/MARKERS function block several clicks counterclockwise. Each click reduces the frequency by

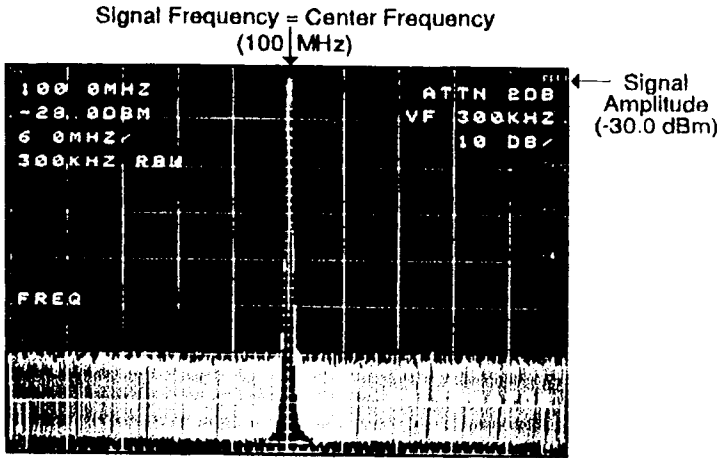

Figure 3-5. Calibration signal fundamental.

the currently selected tuning increment (0.02 times the span/div, or 0.12 MHz in this case). The control functions as the "fine" frequency adjustment. Rotating the knob clockwise increases the frequency at the same rate.

Continue turning the knob in either direction until the signal is centered. Your screen should now resemble Figure 3-5.

The signal frequency is 100 MHz and the signal peak is 0.2 division below the reference level, so its amplitude is -30 dBm:

$$-28 \text{ dBm ref level} - 0.2 \text{ div} \times 10 \text{ dB/div} = -30 \text{ dBm}$$

By using only the frequency, span, and reference level controls you've just verified the basic operation of the 2712 Spectrum Analyzer, and determined the frequency and amplitude of its calibration signal. One, two, three.....how simple it can be!

By using these same controls plus one other, it not only gets easier, but also more accurate. You'll find out how in section 5.

SECTION
4

OPERATION
SUMMARY

SECTION 4

OPERATION SUMMARY

This section provides an overview of the 2712 display, menus, controls, and connectors. The experienced spectrum analyzer user will find it a handy guide to most features of the 2712.

DISPLAY SCREEN

The 2712 display consists of a 8 division high by 10 division wide (256 x 512 point) graphical sweep screen with a 16 row by 32 character text screen overlay. In spectral display mode both the graphic and text data are normally present, although the text screen can be toggled on and off by pressing the READOUT key. In menu display mode only the text screen is normally present, but the sweep display can be turned on (see *The Spectral Display In Menus* in section 6).

The entire screen area is available for the sweep display, but contents of the text screen are placed in predetermined screen locations. Figure 4-1 shows the text screen layout used in spectral display mode. When the optional "Display Title" line is not used, rows 2-11 and rows 13, 14, and 15 move up one.

Figure 4-2 shows the text screen for menu display mode. The menu footer area contains prompts, general information, and data entries including:

- Which key to press to return to the spectral display
- Which key to press to back up one menu level
- Which menu key was pressed to enter this menu
- What data to enter
- Data that has already been entered
- Which terminator key to press

LINE #	SCREEN CONTENT
1	Display Title (optional)
2	Center Freq/Start Freq RF Atten/Mkr Freq/Counter Freq
3	Reference Level Vid Filtr BW/Marker amplitude*
4	Horizontal Scale "TRK" Indicator Vert Scale/"QP" Ind*
5	Resolution BW Blank/TV Channel/Video Line
6	"UNCAL" Indicator Single Sweep Messages
7	Error Message
8	User-Defined Program Title
9	Displayed Message
10	UDP Status
11	Keypad entry/WFM to Save
12	Real-time Clock Display
13	
14	
15	TG Amplitude "CALIBRATOR" Indicator/TG Tracking
16	"WARMUP TIME 15 MIN" Message/GPIB & RS-232 Status

Figure 4-1. Layout of the text screen in spectral display mode.

*May also contain C/N, NOISE NORM'D, BW, & OBW results.

LINE #	SCREEN CONTENT
1	Menu Title
2	
3	
4	Up To 10
5	Items (0-9) Displayed
6	Here
7	:
8	:
9	:
10	:
11	:
12	:
13	Error Message
14	Data Entry
15	
16	Footer area containing prompts general information, and data entries.

Figure 4-2. Layout of the text screen in menu display mode.

CONNECTORS, CONTROLS, AND MENUS

Most of the 2712 front-panel controls are located in function blocks which are denoted by their borders or background colors. Each block contains related controls. The central gray-colored block contains the fundamental center (or start) frequency, span, and reference level controls. For convenience, one function block is dedicated exclusively to menu display. The control panel and its major functional areas are shown in Figures 4-3 to 4-8. Detailed discussions of the controls may be found in section 5.

Trace alignment controls and various input/output connectors are located at the rear of the 2712. Figure 4-9 shows the 2712 back panel and its connectors. The alignment controls are discussed at the end of section 5 under *Miscellaneous Controls*, and the connector terminations are described in section 7, *External Input and Output*.

The menus are shown in Tables 4-1 to 4-8. *Some menu items are not present.* These are either absent from the instrument itself, or represent lower level menus present in the instrument but intended primarily for factory calibration and troubleshooting.

A brief description of the function of each of the listed menu selections is given. The functions of the menu selections are discussed in greater detail in section 6, *Software Controls - The Menus*.

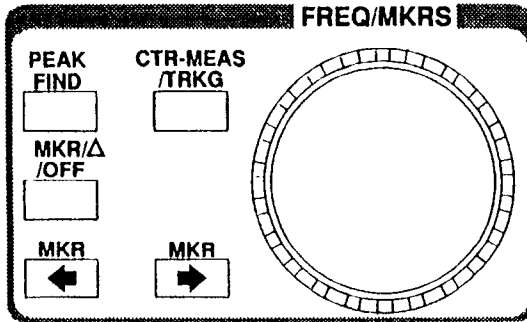
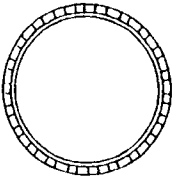

Figure 4-3. The frequency/marker function block.

FREQ/MKRS



In normal spectral display mode, the knob changes the center or start frequency by .02 of the span/div per click; in programmed or tabular tuning modes by the designated tuning increment per click; in ZERO SPAN by a percent of the resolution BW per click (see *Selecting the Tuning Increment* in section 6.) In other modes it may control marker horizontal position, video line number, or TG tracking.

CTR-MEAS

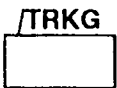

One press initiates a center measure (frequency of signal nearest center screen, or nearest the marker if active, is measured and made the new center frequency). Signal frequency and amplitude displayed at upper right of screen. Two quick presses enter signal track mode (continuously repeated center measures, enabling a drifting signal to be tracked); signal frequency readout is optional in this mode. Third press returns to normal operation.

Moves the marker to the highest on-screen signal peak (turns the marker on if it's not active). Signals must be above the detection threshold (see *Setting the Signal Threshold* in section 6).

**PEAK
FIND**



First press turns on a single marker at center screen, its position controllable with the **FREQ/MKRS** knob. Second press fixes the position of the first marker and turns on a second marker (delta marker mode), its position controllable with the **FREQ/MKRS** knob. Third press turns off both markers.

**MKR/Δ
/OFF**



Each key, respectively, jumps the moveable marker from its current position to the next on-screen signal peak to the left or right. Signals must be above the detection threshold (see *Setting the Signal Threshold* in section 6).

MKR



MKR



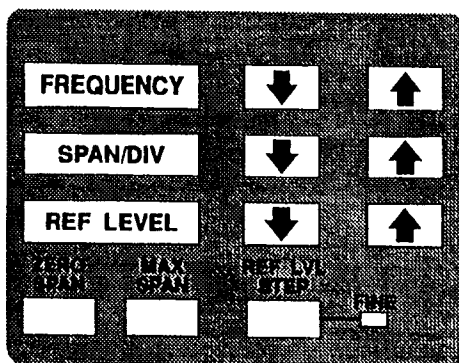

Figure 4-4. Fundamental analyzer controls.

FREQUENCY

Selects the center or start frequency for immediate entry mode. **FREQ** appears on screen at left center. Enter the desired frequency from the keypad; terminate with Hz, kHz, MHz, or GHz key.

Range: 0 Hz to 1.8 GHz

SPAN/DIV

Selects the span per division for immediate entry mode. **SPAN** appears on screen at left center. Enter the desired span/division from the keypad; terminate with Hz, kHz, MHz, or GHz key.

Range: 1 kHz to 180 MHz

REF LEVEL

Selects the reference level for immediate entry mode. **REFL** appears on screen at left center. Enter the desired reference level from the keypad; terminate with +dBx or -dBx key.

Range: +20 to -70 dBm (or equivalent in other units)

The arrow keys increase (▲) or decrease (▼) the **FREQUENCY**, **SPAN/DIV**, and **REF LEVEL** by a specified amount. They are always active in spectral display mode, even if the parameter is not selected for immediate entry.



FREQUENCY change: equivalent of 50 knob clicks in **AUTO** tuning increment mode, and by the designated tuning increment in other modes.

SPAN/DIV change: in 1-2-5 sequence from 1 kHz to 180 MHz.

REF LEVEL change: 1 dB or 10 dB per step depending on **REF LVL STEP** setting.

Shortcuts, respectively, to the zero span and maximum span settings. The keys are toggles; one press activates the setting, the second returns to the span used prior to the first press.

ZERO



and

MAX

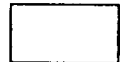

ZERO SPAN: no frequency sweep, horizontal axis calibrated in time/div, and the display is a time domain representation of the signal at the indicated center or start frequency

MAX SPAN: 180 MHz/div (often used to view full input range of 0-1.8 GHz)

Toggles the amount by which the **REF LEVEL** arrow keys change the reference level between 1 dB and 10 dB per press. The adjacent **FINE** indicator is illuminated when 1 dB is selected.

**REF LVL
STEP**

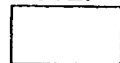

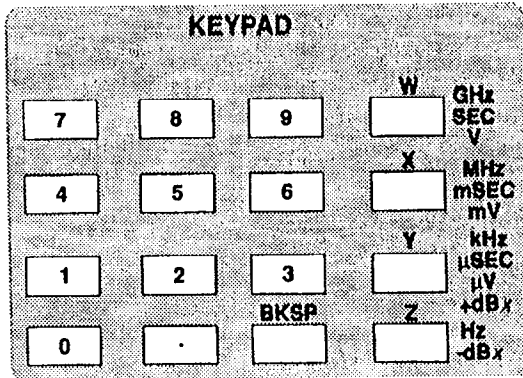

Figure 4-5. The keypad.

NUMERIC KEYS (0 - 9)

Numeric keys are used to enter numerical values in immediate entry mode or in response to menu prompts. They are also used to select the numbered items from menus.

TERMINATOR KEYS (W, X, Y, Z)

The terminator keys signify the end of an entry, and supply the appropriate units for the entry. They are context sensitive; if you press X, the 2712 automatically interprets it as MHz, mSEC, or mV depending on the parameter being entered.

DOT KEY (.)

The dot key supplies the decimal point in numeric entries, and can be used as a period in label and title entries.

BACKSPACE KEY (BKSP)

The BKSP key erases the last character pressed in data entry modes, and backs up one menu level when menus are active.

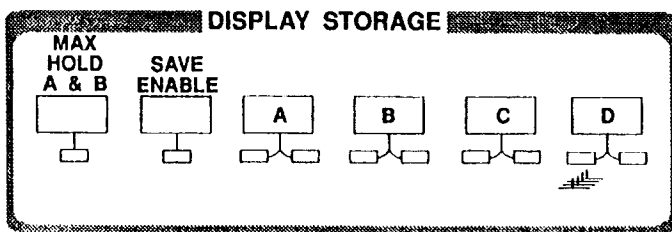

Figure 4-6. Display register control.

REGISTER SELECT AND SAVE KEYS (A, B, C, D)

Pressing the A, B, C, or D key when **SAVE ENABLE** is not armed turns its respective register on and off for display. When the register is displaying data (saved or current), the red LED to the lower right of the key is lit.

When **SAVE ENABLE** is armed, pressing the A, B, or C key:

- stores the current sweep if the register is cleared
- clears the register if it contains saved data.

The saving or clearing action occurs whether the register is displaying data or not. The green LED to the lower left of the key lights when the register contains saved data.

Pressing the D key when **SAVE ENABLE** is armed toggles the 2712 in and out of waterfall display mode. All registers must first be clear. Individual sweeps cannot be saved in D.

Arms the save (clear) function. Press **SAVE ENABLE** and then press the key corresponding to the register to be saved (cleared). The LED below the key lights when **SAVE ENABLE** is armed.



Enables max hold mode. When **MAX HOLD** is enabled, the A and B registers retain the largest signal observed (unless they contain saved waveforms). The LED below the key lights when **MAX HOLD** is active.

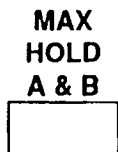

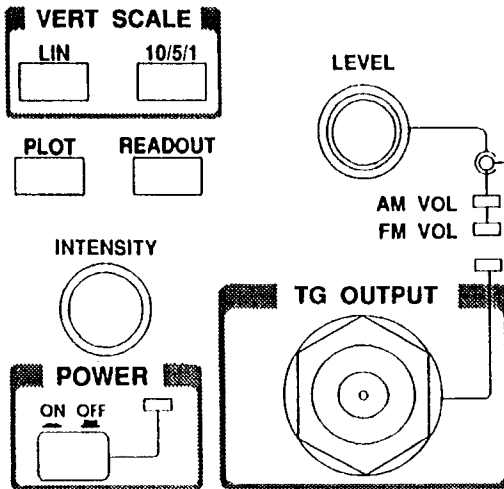

Figure 4-7. Vertical scale and other controls.

10/5/1



Pressing repeatedly cycles the vertical scale in a 10-5-1-10... dB/div sequence in LOG (logarithmic) display mode.

LIN



Toggles the vertical display mode from LOG (logarithmic) to LIN (linear) and back again. Scale factor is controlled by the reference level controls in LIN mode and by [10/5/1] in LOG mode.

PLOT



Initiates a screen plot on an optional printer or plotter. Plotter and interface must be correctly configured (see *System Configuration* in section 6).

READOUT

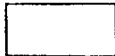

Toggles the on-screen readouts on and off. Use when readouts overlay data, or to eliminate blanking intervals in analog display.

Toggles 2712 power on and off. Green LED next to key is illuminated when power is on.

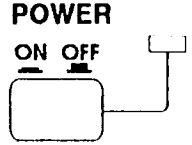

Turning the knob clockwise increases CRT brightness.

INTENSITY

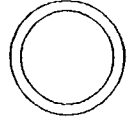

Inner knob sets trigger level in INT, EXT, and (AC) LINE trigger modes (as on a conventional oscilloscope), horizontal position in manual scan mode, picture framing in optional video monitor mode, and variable TG level when the optional tracking generator is installed. Outer knob controls volume of the AM and FM demodulators.

LEVEL

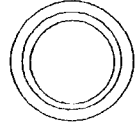

Lights when the AM or FM demodulators are active to indicate the outer knob of the LEVEL control sets audio volume. See **DEMOD/TG** in section 6.



The optional tracking generator (TG) output. An N-type, 50 ohm connector. The LED above the function block lights when the TG is turned on. See **DEMOD/TG** in section 6).

TG OUTPUT

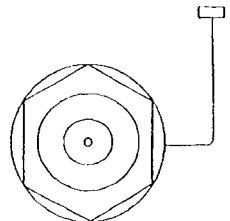

Amplitude range: 0 to -48 dBm
 Frequency range: synchronous with 2712
 but can be offset from approximately
 -5 kHz to +60 kHz

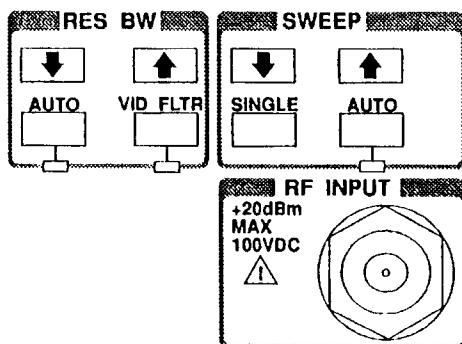
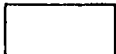

Figure 4-8. Resolution BW and sweep control.

VID FLTR



Normally the 2712 smooths the detected signal with a video filter having a bandwidth equal to the resolution BW. The filter bandwidth is indicated in the right-hand readout column. However, pressing [VID FLTR] toggles an alternate, automatically selected or user-designated, video filter on and off. Its bandwidth replaces the normal video filter readout. You can designate the video filter bandwidth using the UTIL Menu (see *Menu-Entered Control Settings* in section 6).

Automatic selection: 1/100 of the resolution BW

Fixed range: 3 Hz to 300 kHz and WIDE in a 1-3 sequence

NOTE

The EMC filters/QP detector (Option 12) alters video filter selections when active. See *Making EMI/EMC Measurements* in section 6.

SINGLE

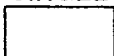

Press the SINGLE key to place the 2712 in a single sweep mode similar to a conventional oscilloscope. SGLSWP MODE appears on screen. With the 2712's sweep in (the default) free run mode, press the key again to start a sweep. In other trigger modes, the sweep begins with the first trigger signal following entry into single sweep. SGLSWP ARM appears briefly at the start of each sweep. Pressing [AUTO] in the SWEEP function block exits single sweep mode, but preserves the current auto or manual sweep rate selection mode.

The **AUTO** keys in the **RES BW** and **SWEEP** function blocks toggle the analyzer into and out of automatic resolution BW and sweep rate selection modes respectively. The **SWEEP AUTO** key also exits single sweep mode (but preserves sweep rate selection mode). The LEDs below the keys are lit when automatic mode is selected. When toggling out of automatic mode, the resolution BW and sweep rate remain as they were until manually changed. When toggling into automatic mode, the analyzer selects the resolution BW and sweep rate appropriate to the currently selected span.

AUTO

The **RES BW** and **SWEEP** arrow keys increase (▲) and decrease (▼) the resolution BW and sweep rate (time/div) in a specified sequence. They are always active in spectral display mode, but using either disables automatic resolution BW or sweep rate selection, respectively.



- RES BW:** sequences through the installed filters
 Basic instrument: 300 Hz, 3 kHz, 30 kHz, 300 kHz, 5 MHz
 Option 14¹: adds 1 kHz, 10 kHz, 100 kHz, 1 MHz
 Option 12¹: adds 1 kHz, 9 kHz, 120 kHz, 1 MHz and replaces the 300 Hz filter with a 200 Hz filter
- SWEEP:** follows 1-2-5 sequence from 2 sec/div to 1 μsec/div.
 Rates <100 μsec/div are useable only in analog display mode.



The analyzer RF signal input is an N-type, 50 ohm connector. **OBSERVE**
MAXIMUM INPUT RATINGS.

- Input signal:
 Maximum amplitude: $\leq +20$ dBm
 Maximum DC: 100 Volts
 Frequency range: 9 kHz to 1.8 GHz

**+20dBm
 MAX
 100VDC**

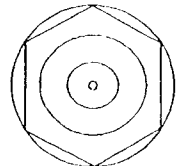
**RF INPUT**

¹ Options 04, 12, and 14 are mutually exclusive.

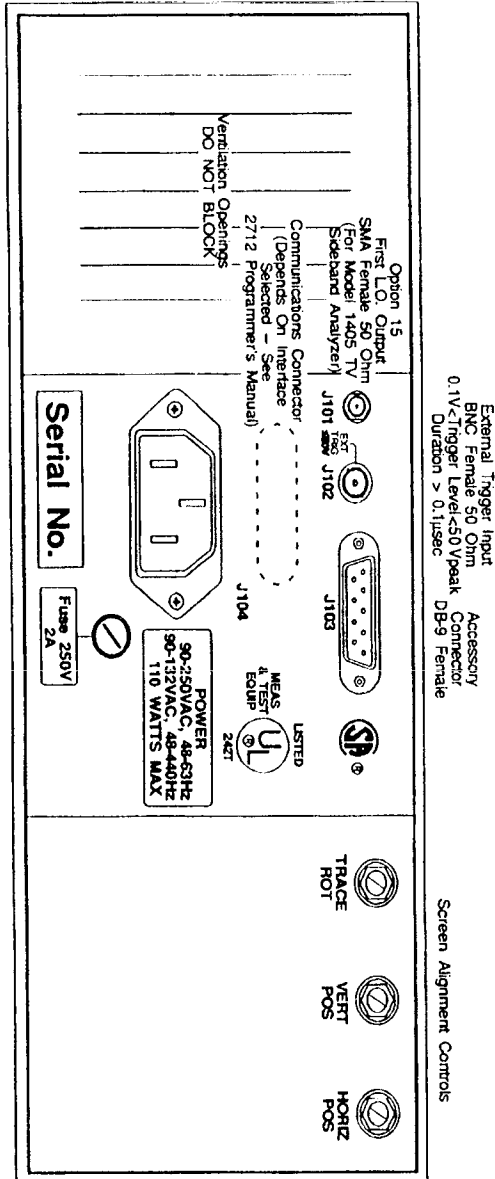

OBSERVE RATINGS PRINTED ON 2712

ALWAYS USE SAFETY GROUND

Figure 4-9. The 2712 back panel.

Table 4-1. The Sweep/Trigger (SWP/TRIG) Menu.

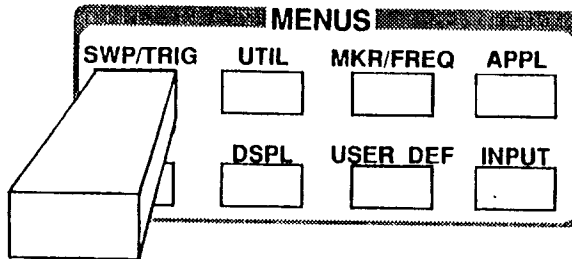

TRIGGER MENU	
0 FREE RUN	Sweep runs continuously
1 INTERNAL	Triggers sweep from input signal
2 EXTERNAL	Triggers sweep from signal at external trigger input
3 LINE	Triggers sweep from AC line
4 TV LINE	Triggers sweep from TV horizontal sync pulse (see setup table)
5 TV FIELD	Triggers sweep from TV vert sync pulse
SWEEP MENU	
6 SWEEP RATE	Enables keypad entry of sweep rate
7 MANUAL SCAN	Toggles manual scan on & off; when on, LEVEL controls horizontal position
8 SYNC POLARITY²	Toggles video sync pulse polarity between plus and minus
9 SETUP TABLE	
HORIZONTAL LINE TRIGGERING²	Determines which sync pulse triggers sweep when TV LINE trigger selected:
0 CONTINUOUS	Any sync pulse (line) triggers sweep
1 KNOB SELECTABLE²	FREQ/MKRS knob selects line number; number shown on screen; knob also selected by [MKR/FREQ][2]
2 KEYPAD ENTERED LINE	Trigger on pulse entered from keypad
3 KEYPAD ENTRY	Enables keypad entry of trigger pulse
4 TV LINE STANDARD	Choose NTSC, PAL, SECAM, or OPEN

² Requires Option 10 (Video Monitor)

Table 4-2. The Utility (UTIL) Menu.

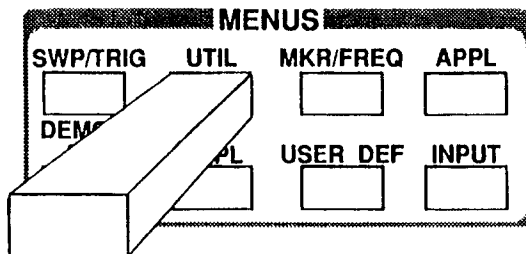

0 INITIALIZE INSTR SETTINGS	Reinitializes 2712; user-defined power-up settings implemented; if no user settings, factory default settings used
1 STORED SETTINGS 0 LAST POWER-DOWN 1 FACTORY DEFAULT POWER-UP 2 USER-DEFINED POWER UP 3 & UP USER-DEFINED SETTINGS	Saves & restores settings from a list of up to 37 choices; choices 0 & 1 are reserved; contents of display registers are saved along with settings; settings list consists of 4 screens with 9 or 10 choices each
2 KEYPAD ENTERED SETTINGS	
0 FREQUENCY	Enables keypad entry of center/start freq
1 REFERENCE LEVEL	Enables keypad entry of reference level
2 SPAN/DIV	Enables keypad entry of span/div
3 RF ATTENUATION	Selects FIXED or AUTO RF attenuation and enables keypad entry of fixed atten
4 RESOLUTION BW 0 AUTO 1 FIXED SCALE	Selects FIXED or AUTO RBW and enables keypad entry of fixed RBW
5 VIDEO FILTER 0 AUTO 1 FIXED	Selects FIXED or AUTO video filter BW and enables keypad entry of fixed video filter BW; only method of manually setting video filter BW

6 VERTICAL SCALE 0 LOG 1 DB/DIV 1 LOG 5 DB/DIV 2 LOG 10 DB/DIV 3 LINEAR	Selects vertical scale factor of 1, 5, or 10 dB/div, or linear scale
7 SWEEP RATE	Enables keypad entry of sweep rate
3 NORMALIZATIONS 0 ALL PARAMETERS 1 FREQUENCY ONLY 2 AMPLITUDE ONLY 3 TRACKING GENERATOR ONLY ³	Enables internal normalization of 2712 frequency or amplitude parameters, or both (ALL PARAMETERS); use TRACKING GENERATOR ONLY to normalize TG
4 SYSTEM CONFIGURATION	
0 COMMUNICATIONS PORT CONFIG	Toggles between direct and interrupt driven I/O; displays status messages
0 GPIB⁴	Select to configure GPIB port
0 STATUS	Toggles GPIB port on and off line
1 GPIB ADDRESS	Enable keypad entry of GPIB address
2 POWER ON SRQ	Toggles generation of service request at power-up on and off
3 EOI/LF MODE	Selects hardware (EOI) or hardware and software (LF) message termination; all TEK instruments support EOI
4 TALK ONLY MODE	Use TALK ONLY when sending data to printer/plotter from 2712 (no controller)

³ Requires Option 04 (Tracking Generator)

⁴ GPIB or RS-232 are present only if the respective port is installed

Table 4-2 (continued)

2 RS-232 ⁵	Select to configure RS-232 port
0 STATUS	Toggles RS-232 port on and off line
1 BAUD RATE	Steps through baud rates from 110 to 9600. Start/stop bits auto-selected
2 DATA BITS	Toggles between 7 and 8
3 PARITY	Cycles NONE, ODD, or EVEN
4 EOL	Choose message terminator; CR, LF, or CR and LF
5 FLOW CONTROL	Handshaking protocol; HARD(ware), SOFT(ware), or NONE
6 ECHO	Toggles echo response on and off
7 VERBOSE	Toggles VERBOSE on and off; when on every command receives a response
1 SCREEN PLOT CONFIGURATION	Select to configure communications port for printer/plotter applications
0 COMM PORT	Indicates installed communications port
1 PLOTTER LANGUAGE	Select printer/plotter language; HPGL for plotters, EPSON FX for printers
2 PLOT SPEED	Toggles through a range of plotter speeds from SLOW to FASTEST
3 PLOTS PER PAGE	Toggles between 1 & 4 plots per page
4 PLOT POSITION	Select page position for each of 4 plots
2 PRINTER CONFIGURATION	Toggles printer output between comm port and screen (CRT)
3 INSTRUMENT CONFIGURATION	
0 AUDIO ALERT	Toggles audio tone on for keyclick only, error only, both, or off
1 MINIMUM SIGNAL SIZE	Enables entry of signal amplitude difference necessary for marker functions
2 WAVEFORM TO PRINTER	Toggles output on and off following each sweep of ASCII- or binary-formatted waveform data to comm port
3 WVFRM OUTPUT FORMAT	Toggles comm port output between ASCII & binary

⁵ GPIB or RS-232 are present only if the respective port is installed

4 PHASELOCK	Selects OFF or AUTO for phaselock
5 FREQUENCY CORRECTIONS	Toggles frequency correction on & off
6 SPECTRAL DSPL IN MENU	Causes the spectral display to overlay the menus so you can see the display while using the menus
7 SWEEP HOLDOFF	Toggles sweep holdoff between NORMAL & SHORT HOLDOFF
4 REAL-TIME CLOCK SETUP	Enables keypad entry of clock data
5 STORED SETTINGS PROTECT	Prevents/enables the deletion of control settings; when protected, stored settings cannot be deleted but waveforms stored with them can
6,7 Factory troubleshooting aids	
9 INSTALLED OPTIONS DISPLAY	Lists installed options on screen
5 INST DIAGNOSTICS /ADJUSTMENTS	
0,1,3,4,6 Various factory troubleshooting aids	
2 MANUAL ADJUSTMENTS	
2 DISPLAY STORAGE CAL	Used with back panel controls to adjust trace alignment
5 SERVICE NORMALIZATIONS	
0 FREQUENCY NORM'ZATIONS	0-2 are used (with external signals or equipment in some cases) to calibrate the 2712's internal parameters; item 3 normalizes the tracking generator
1 REFERENCE NORM'ZATIONS	
2 AMPLITUDE NORM'ZATIONS	
3 TRKNG GEN NORM'ZATION ⁶	
4 NORMALIZATION VALUES	Displays normalization parameters
5 PRINT ALL NORM VALUES	Sends normalization parameters to printer
6 NORM DEBUG TO PRINTER	Sends messages during normalization to printer
7 SERVICE REQUEST	Generates an SRQ for testing purposes
9 MORE	
0 PRINT READOUTS	Sends on-screen readouts to printer

⁶ Requires Option 04 (Tracking Generator)

Table 4-3. The Marker/Frequency (MKR/FREQ) Menu.

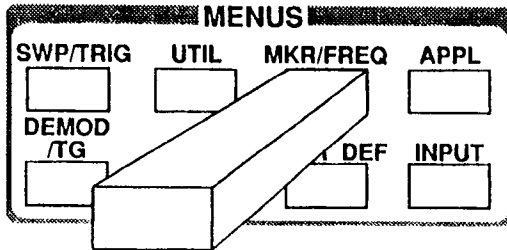

0 THRESHOLD	Enables keypad entry of signal ampl'd difference for marker and limit detector functions
1 PROGRMD TUNING INC 0 CENTER FREQ 1 MARKER FREQ 2 KEYPAD-ENTERED INC 3 KEYPAD ENTRY 4 RETURN TO AUTO	Selecting PROGRMD TUNING INC determines whether knob increment equals center freq, current marker freq, or keypad entered freq; 4 returns to AUTO selection of tuning increment
2 KNOB FUNCTION 0 FREQUENCY 1 MARKER 2 VIDEO LINE ⁷	Toggles knob function from frequency to marker control; if TV LINE trigger is active, also enables knob selection of line; if tracking generator (Option 04) is active, can select knob control of TG tracking
3 MARKER TO REFERENCE LEVEL	Changes reference level to the current amplitude of the marker (if active)
4 MOVE MARKER TO NEXT PEAK	Moves marker to next higher or next lower spectral peak
5 TRANSPOSE MARKERS	Interchanges fixed and moveable markers
6 MARKER START/STOP	Makes the start and stop frequencies equal to the current marker positions
7 FREQUENCY START/STOP 0 FREQ START ENTRY 1 FREQ STOP ENTRY	Enables keypad entry of display start and stop frequencies
8 TUNING INCREMENT	Switches amongst AUTO, PROGRMD, & TABULAR tuning increments

⁷ Requires Option 10 (Video Monitor)

9 SETUP TABLE	
0 CENTER/START FREQ	Toggles knob control between start and center frequency
1 COUNTER RESOLN 0 COUNTER OFF WHEN TRKG 1 1 HZ 2 1 KHZ	Turns off counter readout in signal track mode and sets counter resolution to 1 Hz or 1 kHz
2 TABULAR TUNING TABLES 0 : 9	Selects the tuning increment from a list of domestic and foreign broadcast and cable TV frequency standards
3 FREQ OFFSET	Enables keypad entry of a value by which displayed center frequency is offset, but frequency is not actually changed and counter reads correctly; intended for use with frequency shifting devices such as downconverters
4 FREQ OFFSET MODE	Determines whether FREQ OFFSET is ON PLUS, ON MINUS, or OFF (offset value must be entered for ON MINUS to appear)

Table 4-4. The Applications (APPL) Menu.

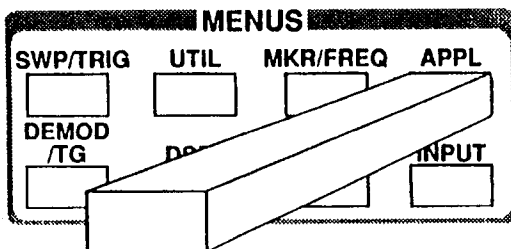

0 BANDWIDTH MODE	Determines BW of a spectral peak at points a designated number of dB down
1 CARRIER TO NOISE	Measures carrier-to-noise ratio at points indicated by markers
2 NOISE NORMALIZED	Measures noise in normalized bandwidth at point indicated by marker
3 SIGNAL SEARCH MENU	Enables entry of signal search parameters
0 BEGIN FREQ	Frequency at which search begins
1 END FREQ	Frequency at which search ends
2 START TEST	Initiates automated signal search
3 DISPLAY RESULTS	Sends results to printer or screen; use UTIL/4/2 to select which
4 OCCUPIED BW	Determines the bandwidth that contains a specified % of the signal energy
5 EMC MODE⁸	Optimizes analyzer gain for measuring high amplitude, short duration signals
6 QUASI-PEAK⁸	Select quasi-peak detector and EMC filters
7 FM DEVIATION MODE	Displays instantaneous FM deviation vertically at 10, 5, or 1 kHz/div

NOTE

All items except SIGNAL SEARCH MENU are toggles which switch the indicated mode on and off.

⁸ Requires Option 12 (Quasi-Peak). Alters video filter selection when active.

See *Making EMI/EMC Measurements* and *Quasi-Peak Measurements* in section 6.

9 SETUP TABLE 0 DB DOWN OF BW MODE 1 NORM BW FOR C/N 2 NOISE NORM'D BW 3 PERCENT OCCUPIED BW	Enables keypad entry of dB down for bandwidth mode, normalized bandwidth for noise & C/N measurements, and the energy percentage for occupied BW measurements
QUASI-PEAK [®] 4 AUTO 5 200 HZ FILTER 6 9 KHZ FILTER 7 120 KHZ FILTER	Determines whether the EMC filter is chosen automatically in QUASI-PEAK mode, or selects a particular EMC filter for QP measurements

Table 4-5. The Demodulator/Tracking Generator (DEMOD/TG) Menu.

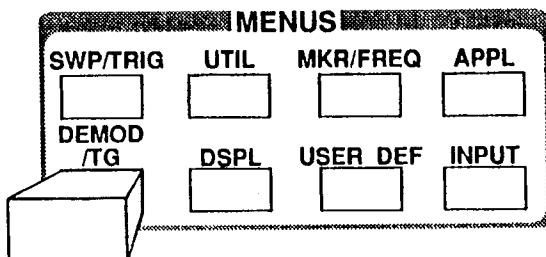

0 OFF	Connects output of AM demodulator, FM demodulator, both, or neither (OFF) to internal speaker and headphone jack; LEVEL knob controls volume
1 AM DEMODULATOR	
2 FM DEMODULATOR	
3 BROADCAST (AM) VIDEO ⁹ SATELLITE (FM) VIDEO	Indicates selected video detect mode and turns it on and off
4 TRACKING GENERATOR ¹⁰	Turns the optional TG on and off
5 TG FIXED LEVEL ¹⁰	Enables keypad entry of TG output level (- 48 to 0 dBm)
6 TG VARIABLE LEVEL ¹⁰	Enables LEVEL control to vary TG output level approx ± 2 dB (uncalibrated)
7 TG TRACKING ¹⁰	Enables FREQ/MKRS knob to vary TG tracking - 5 to +60 kHz re analyzer freq
8 TG EXT ATTEN/AMPL ¹⁰	Enables keypad entry of a correction for external amplifier or attenuator at TG output, and turns it on and off; follow on-screen prompts
9 VIDEO MONITOR SETUP ⁹	
0 VIDEO DETECT MODE	Selects BROADCAST (AM) or SATELLITE (FM) video detection; does not work with scrambled signals
1 SYNC POLARITY	
2 VIDEO POLARITY	Toggles sync pulse and video signal polarity between positive and negative

⁹ Requires Option 10 (Video Monitor)

¹⁰ Requires Option 04 (Tracking Generator)

Table 4-6. User Definable (USER DEF) Menu.

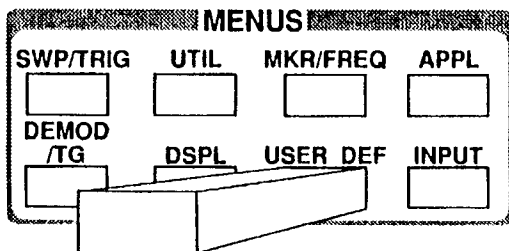

0 program 0 :	User-defined programs (UDP) of key-stroke sequences; recall and execute by pressing [USER DEF]/ [program no.]
8 program 8	
9 USER DEF PROG UTILITIES	Firmware utilities used to create UDPs
0 ACQUIRE/EXIT KEY STROKES	Used to begin acquiring keystrokes or to exit acquire mode without storing UDP
1 TITLE EDIT	Used to create/modify name of UDP
2 WAIT FOR END OF SWEEP	Used as keystroke in UDP to delay UDP until sweep finishes; displays "WAIT FOR END OF SWEEP"; needed by functions utilizing end-of-sweep processing (count, cent meas, etc.)
3 DISPLAY MESSAGE	Use to create/delete messages for on-screen display during UDP execution
4 PAUSE FOR "USER DEF" KEY	Used as a keystroke in UDPs to generate "PRESS USER DEF KEY TO CONTINUE" message and halt program execution until [USER DEF] is pressed
5 CONTINUOUS EXECUTION	When selected, causes subsequently chosen UDP to repeat continuously
6 STORE	Stores the UDP currently being edited in location 0-8; location must be empty before UDP can be stored; if UDP is named, name appears next to number
7 DELETE	Deletes UDPs by number
8 PROTECT	Protects stored UDPs by number from deletion; # indicates protected UDP

Table 4-7. The Display (DSPL) Menu.

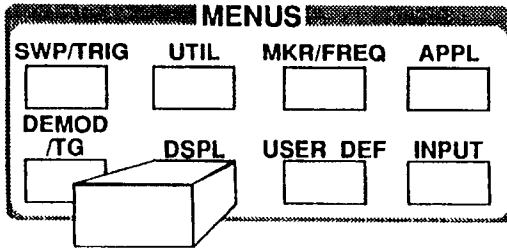

0 DIGITAL/ANALOG	Toggles between all display registers off (analog) and (digital) display register configuration prior to selecting analog
1 ENSEMBLE AVERAGING	
1 INITIATE AVERAGING	Starts averaging process
2 TERMINATE AVERAGING	Ends averaging process
3 MAX	Finds the average maximum, minimum, or max/min spectrum values. MEAN finds the average half way between the max & min points
4 MEAN	
5 MIN	
6 MAX/MIN	
7 NUMBER OF AVERAGES	Averages 1-1024 traces or selects continuous averaging
8 SAVE RESULTS IN DISPLAY	Toggles amongst display registers A, B, and C; indicated register stores average
2 B,C MINUS A	Subtracts contents of A register from B or C registers if they are active
3 B,C MINUS A OFFSET TO	Offsets result of subtraction to top or center of screen (0 difference equals reference level or midscreen)
4 ACQUISITION MODE	Toggles between peak & max/min spectral display
5 TITLE MODE	Enables entry of on-screen title & information; turns title and information display on & off

6 GRATICULE ILLUMINATION	Turns graticule light on and off
7 DISPLAY SOURCE	Toggles between INT and EXT signal source, and indicates mode (AM, FM, QP) when INT is selected
8 DISPLAY LINE	Controls display line and limit detector
1 ON/OFF	Toggles display line (horizontal line at specified amplitude) on and off
2 VALUE ENTRY	Enables keypad entry of display line amplitude
3 DISPLAY LINE TO MARKER	Sets display line amplitude to current marker amplitude
4 LIMIT DETECTOR	Sounds audible alarm (limit detector) if a) signal is above line b) signal is below line or c) signal is below line but above threshold. Set using MKR/FREQ/9/1
9 MIN HOLD IN WFM nn	Accumulates minimum value of spectrum and enables selection of register in which to store result

Table 4-8. The Input (INPUT) Menu.

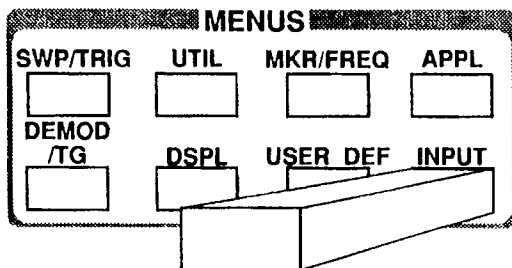

1 PREAMP	Toggles built-in preamp on and off
2 50 OHM DBM/75 OHM DBMV	Computes conversion factors for switching between 50 Ω source/dBm units and 75 Ω source/dBmV units; rescales display
3 REF LEVEL UNIT 0 DBM 1 DBMV 2 DBV 3 DBUV 4 DBUW 5 DBUV/M IN WFM x 9 DBUV/M SETUP	Selects indicated reference unit: milliwatt reference millivolt reference volt reference microvolt reference microwatt reference microvolt per meter reference; use DSPL to select display register Enables entry of antenna factors and test distances
4 1ST MXR INPUT LVL	Enables keypad entry of first mixer input amplitude which deflects display to the reference level
5 RF ATTENUATION	Enables keypad entry or AUTO selection of RF attenuation
6 EXTERNAL ATTEN/AMPL 0 ON/OFF 1 ATTEN/AMPL ENTRY	Signifies whether external attenuation or amplification is present, and enables keypad entry of amount
9 CAL SIGNAL @100MHZ -30DBM	Toggles built-in calibrator on and off

SECTION
5

DEDICATED
CONTROLS

SECTION 5

DEDICATED CONTROLS

This chapter describes in detail the hard-wired, or dedicated, controls of the 2712. All of the controls are on the analyzer front panel except for the trace alignment controls, which are on the back. You will learn to use the controls to effectively measure signal spectra. We look first at the controls most fundamental to spectrum analysis.

FUNDAMENTAL OPERATIONS

Earlier you measured the amplitude and frequency of a continuous narrowband signal (the calibration signal) using only three controls. In this section we'll repeat the initial measurement, but this time we'll look more closely at the **FREQUENCY**, **SPAN/DIV**, **REF LEVEL** and associated controls contained in the gray-colored central function block¹. These controls are most fundamental to spectrum analyzer operation. You can even perform the majority of spectral measurements with only these controls if you choose.

We begin by setting the analyzer controls to the values shown in the settings box at the top of the next page. This is most easily done by pressing **[UTIL]/[1]/[1]** to restore the factory defaults and then **[INPUT]/[9]** to turn on the calibration signal.

¹ You can also use the Utility Menu to reset the frequency, span, and reference level (see *Menu-Entered Control Settings* under the **UTIL** discussion in section 6).

900.0MHz	(AUTO SWEEP)	ATTN 50DB
20.0DBM		VF WIDE
180MHz/ MAX		10 DB/
5MHz RBW (AUTO)	CALIBRATOR	

Press [FREQUENCY]/[4]/[0]/[0]/[MHz] to set the analyzer center frequency to 400 MHz. Remember that in **MAX SPAN** the marker changes position and not the frequency at screen center. Press the **REF LEVEL** down arrow key three times to reduce the reference level to -10.0 dBm.

SPAN/DIV



The **SPAN/DIV** keys are used to change the

frequency span represented by one horizontal division on the screen. The arrow keys directly increase or decrease the span per division, and [SPAN/DIV] enables you to enter the span per division directly from the keypad (immediate entry mode).

Beginning with maximum span, press:



to the right of [SPAN/DIV] several times to decrease the span/div to 20 MHz.² See how the analyzer "zooms in" on the spectral display? Now press:



until the span/div increases to 180 MHz. Watch the spectral display "zoom out" just as though it was moving away from you.

These keys perform inverse functions. The upward-pointing arrow *increases* the span/div, compressing or squeezing the spectrum together. The downward-pointing arrow *decreases* the span/div and expands or stretches the spectrum. The arrow keys are active whenever the 2712 is in spectral display mode.

² If you request a narrow span before the 2712 is completely warmed up, you may get a **NORMALIZATION SUGGESTED** message. This message should not appear after the analyzer warms up.

Experiment by pressing each arrow key until the span/div no longer changes. You'll notice two characteristics of the 2712:

- Span/div changes in a 1-2-5 sequence between 1 kHz and 100 MHz, plus 180 MHz/div in maximum span.
- Resolution BW changes automatically as the span changes (later you'll learn how this can be changed).

The preset span/div values are sufficient for most of your measurement needs. However, other spans/div can also be specified to the nearest tenth of a unit.

To set the span/division to an arbitrary value, press **[SPAN/DIV]** to place span in immediate entry mode. Notice that the abbreviation **SPAN** appears at left center of the 2712 screen.

The **SPAN** indicator tells you that you can enter the span/div directly from the keypad. This is done by keying in a permissible value followed by an appropriate terminator key. Any value from 1 kHz/div to 180 MHz/div is acceptable. You can enter up to 25 characters, but the 2712 rounds and stores the value to 3 decimal points. In the spectral display, the value is shown rounded to one decimal point (to see the stored value, press **[UTIL]/[2]**).

For instance, to set the span/division to 33.3 MHz, press:

[3]/[3]/[.]/[3]/[MHz]

The numbers you type appear on screen to the right of **SPAN**. If you make a mistake, you can correct it any time prior to pressing **[MHz]** by repeatedly pressing **[BKSP]** (the backspace key) until the incorrect number disappears, and then typing the correct value.

Pressing a terminator key (**[W]**, **[X]**, **[Y]**, **[Z]**) determines the units and enters the data. The **X** key can represent units of **MHz**, **mSEC**, or **mV**. Because the immediate span/div entry mode requires a frequency, the 2712 correctly interprets the currently displayed value as 33.3 MHz when you press **[X]**. If a time or voltage unit had been required, the 2712 would have interpreted your entry as 33.3 mSEC or 33.3 mV, respectively, when you

pressed [X]. On the other hand, had you wanted the entry to represent a span/div of 33.3 kHz, you would have pressed [Y] instead of [X].

Press [↓]. The span/div changes to 20 MHz, the nearest span/div value in the downward direction in the normal 1-2-5 sequence. Had you pressed [↑], the span/div would have changed to 50 MHz, the nearest value in the upward direction.

The span readout now indicates 20MHz/ and the 4th harmonic of the calibration signal is at the center frequency of 400MHz.

MAX



There is often a need, such as when connecting new signals to the 2712 input, to view the entire input frequency range of the analyzer. In this mode, the 2712 is in MAX SPAN. A dedicated front panel key is provided to conveniently enter and exit this mode.

Press [MAX] to obtain the largest span available on the 2712. The span/div readout now indicates 180 MHz/ MAX. Press [MAX] a second time to return to 20 MHz/.

Many of the keys on the 2712 are toggle-action. The ability to undo an action by pushing the same button that carried out the action is typical. [MAX] is a toggle-action key taking you from the current span/div to 180 MHz/div and back again.

ZERO

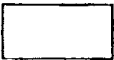

For the next experiment, set the center frequency to 100 MHz and notice that the calibration signal is centered in the display.

Press [ZERO]. The signal is a straight, horizontal line! In zero span mode the analyzer remains at a fixed frequency. What you see is the variation in time of the signal power coming through the RBW filter at that frequency. Since the calibration signal has constant amplitude, the display is constant. **Slowly increase the center frequency by turning the FREQ/MKRS knob.** The noise generated internally by the analyzer has a time-varying random amplitude. You will notice the signal amplitude decrease and the noise increase as you tune away from the calibration signal.

In the zero span mode, the 2712 does not sweep the frequency spectrum. Rather, the local oscillator remains at a fixed frequency so that the resolution bandwidth filter brackets the designated center frequency. Because the display screen is still swept, the span readout indicates sweep speed (time per division rather than frequency per division). The word ZSPAN follows the sweep speed to denote zero span operation. In a sense, you have turned your spectrum analyzer into an oscilloscope. [ZERO] is another toggle-action key. Press the key again to return to 20 MHz/div span.

FREQUENCY



FREQ/MKRS

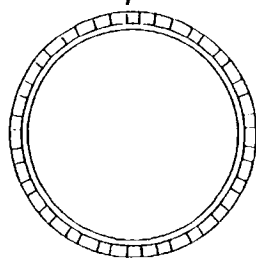

Change the span to 100 MHz/. Turn the **FREQ/MKRS** knob a few clicks clockwise. Each click of the knob increases the center frequency by 2.0 MHz. Turn the knob counter-clockwise and the center frequency decreases by the same amount. Now reduce the span to 20 MHz/. Again turn the **FREQ/MKRS** knob a few clicks clockwise. The spectral display appears to move sideways at about the same rate as it originally did. However, it is now moving only 0.4 MHz per click. We call this visual behavior *constant rate tuning*. It occurs because the knob normally changes the center frequency at 0.02 of the span/div per click.³ Obviously, it would take a great many clicks to change the frequency by 100 MHz at 20 MHz/div (250, to be exact).

The knob remains active whenever the 2712 is in spectral display mode.

Press [**↑**] to the right of [**FREQUENCY**]. The frequency changes by 20 MHz. It would take only 5 presses of the arrow key to change the frequency by 100 MHz – a big improvement.

³ In MAX SPAN the indicated frequency changes alternately by 3 or 4 MHz, and as a percent of the Resolution BW in ZERO SPAN. *Selecting the Tuning Increment* in section 6 teaches you how you can change the tuning rate.

Normally⁴ the frequency arrow keys change the frequency by 50 times the knob click.

Change the span/div to 100 MHz. Now press [↓] adjacent to [FREQUENCY]. The frequency changes by 100 MHz (50 x (.02 x 100 MHz)). At large spans/div the arrow keys can change the frequency very rapidly.

The arrow keys perform inverse functions. The upward-pointing arrow increases the center or start frequency, whereas the downward-pointing arrow lowers it. The keys remain active whenever the 2712 is in spectral display mode.

For very large frequency changes, or to preset a known center or start frequency, direct entry mode is faster. **To set the center or start frequency to a predetermined value, press [FREQUENCY] to place the center or start frequency in immediate entry mode. Notice that the abbreviation **FREQ** has appeared at left center of the 2712 screen.**

The **FREQ** indicator tells you that you can enter the center frequency directly from the keypad (immediate entry mode). This is done by keying in a permissible value followed by an appropriate terminator key. You can enter any value from 0 Hz to 1.8 GHz, but the 2712 low-frequency specification is 9 kHz. Your entry can contain up to 25 characters, but regardless of how many you enter, the 2712 attempts to control frequency to the nearest Hertz, and reads out the frequency at the top of the left-hand data column to 1% of the span/div.

For instance, to set the center frequency to 1.25 MHz press:

[1]/[.]/[2]/[5]/[MHz]

The numbers you type appear on screen to the right of **FREQ**. If you make a mistake, correct it any time prior to pressing **[MHz]** by repeatedly pressing **[BKSP]** (the backspace key) until the incorrect number disappears, and then type the correct value.

Pressing a terminator key (**[W]**, **[X]**, **[Y]**, **[Z]**) determines the units and enters the data. The **X** key can represent units of MHz,

⁴ In **AUTO** tuning increment mode. In other modes, the arrow keys change the frequency by the designated tuning increment. See *Selecting the Tuning Increment* in section 6.

mSEC, or mV. Because the immediate frequency entry mode requires a frequency, the 2712 interprets the currently displayed value as 1.25 MHz when you press [X]. If a time or voltage unit had been required, the 2712 would have interpreted your entry as 1.25 mSEC or 1.25 mV, respectively, when you pressed [X]⁵. On the other hand, had you wanted the entry to represent a frequency of 1.25 GHz, you would have pressed [W] instead of [X].

Now use the direct entry method to set the center frequency to 100 MHz ([FREQUENCY]/[1]/[0]/[0]/[MHz]).

REF LEVEL



Let's review reference level adjustment.

Notice the height of the signal peak and then press [↓] to the right of [REF LEVEL].

The signal peak appears to increase 10 dB when you press the key, but this is a bit deceptive. Actually, the calibration signal amplitude does not change when you change the reference level. Instead, the reference level *decreases* (changes in the direction indicated by the arrow key) to -20 dBm and the attenuation to 10 dB. The signal only appears larger because the reference level has been lowered 10 dB and now represents a signal level of -20 dBm, 10 dB or one division greater than the calibration signal.

Reduce the on-screen signal height one division by pressing [↑] adjacent to [REF LEVEL].

The reference level readout *increases*⁶ 10 dB to -10 dBm (again changes in the direction indicated by the arrow) and RF attenuation changes to 20 dB. The signal peak drops one division, but its amplitude is still -30.0 dBm.

⁵ However, neither is a permissible value, and your entry would have been rounded to the nearest allowable value.

⁶ Remember that you often deal with negative numbers when setting the reference level; -10 dBm is larger than -20 dBm.

The arrow keys perform inverse functions. The upward-pointing arrow increases the reference level whereas the downward-pointing arrow lowers it. The keys remain active whenever the 2712 is in spectral display mode.

NOTE

The direction of the arrows always represents the direction of change of the analyzer setting (*up* arrow *increases* the reference level). This results in an inverse relationship with the displayed signal height (*up* arrow *lowers* displayed signal height).

As with frequency and span/div, you can directly enter the reference level from the keypad. This feature is especially handy when you have a good estimate ahead of time of what the signal amplitude is, or when you are simply interested in how much below a given amplitude a particular signal is. For instance, you might want to preset the reference level to -33.9 dBm (+15 dBmV -- later you'll learn to change reference level units) to examine cable TV signals at a customer drop.

To set the reference level to a predetermined value, press [REF LEVEL] to place the reference level in immediate entry mode. Notice that the abbreviation REFL has appeared at left center of the 2712 screen. The REFL indicator tells you that you can enter the reference level directly from the keypad. This is done by keying in a permissible value followed by an appropriate terminator key. You can enter any value from -70 to +20 dBm (or the equivalent in other units). You can enter up to 25 characters, but regardless of how many you enter, the 2712 rounds and displays the reference level to a tenth of a dB.

Set the reference level to -27.5 dBm by pressing:

[2]/[7]/[.]/[5]/[-dBx]

The numbers you type appear on screen to the right of REFL. If you make a mistake, you can correct it any time prior to pressing [-dBx] by repeatedly pressing [BKSP] until the incorrect number disappears, and then typing the correct value.

Pressing a terminator key (only [Y] or [Z] in this case) determines the units. The Z key can represent units of Hz or -dBx. Because the immediate reference level entry mode requires decibels, and because the reference level unit is the dBm, the 2712 correctly interprets the currently displayed value as -27.5 dBm when you press [Z]. If the currently selected reference level units had been dBmV or dBW, the 2712 would have interpreted your entry as such when you pressed [Z]. If a frequency unit had been required, the 2712 would have interpreted your entry as 27.5 Hz when you pressed [Z]. On the other hand, had you wanted to enter a positive reference level, you would have pressed [Y] for +dBx. The 2712 ignores the W or X terminator keys because they do not represent acceptable reference level units.

The calibration signal peak is now less than one division below the reference level. Let's nudge it up a bit.

**REF LVL
STEP**



Press [REF LVL STEP].

Nothing happened on screen, but the red LED next to the key lit. The LED is telling you that the rate at which the reference level arrow keys change the on-screen signal height and reference level is now 1 dB per press rather than 10 dB. Press [↓] three times. The signal peak rises until it is just above the reference level and the readout indicates -30.5 dBm. You cannot get the signal peak closer to the reference level without entering a new reference level in the immediate mode.

Press [↑] ten times and watch the signal peak drop to almost one division below the reference level. The reference level readout should indicate -20.5 dBm.

[REF LVL STEP] is another toggle-action key. Press [REF LVL STEP] again. The LED goes out indicating the reference level is back in 10 dB per press mode. Press [reference level [↓]] and confirm that the reference level returns to -30.5 dBm.

Reset the reference level to -10 dBm.

ENHANCED VERSATILITY

In the preceding subsection you learned about the fundamental controls of the 2712. In this subsection you will learn how the remaining controls enhance your ability to make accurate spectral measurements easily and conveniently. You will discover how to control the resolution bandwidth, vertical scale factor, and sweep speed. You will learn to use display storage and marker control to quickly measure signal amplitude and frequency with maximum accuracy. You will also find out how to make direct spectral comparisons and, with non-volatile RAM (NVRAM), to save important results for future reference.

100.0MHz	(AUTO SWEEP)	ATTN 20DB
-10.0DBM		VF WIDE
20.0MHz/		10 DB/
5MHz RBW (AUTO)	CALIBRATOR	

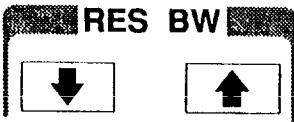

Thus far, we have ignored the RES BW function block. It's been left in AUTO mode which enables you to make measurements

without worrying about where the resolution BW is set, but there are circumstances in which you will want to control the resolution BW yourself. For instance, if you look at the time domain representation of a TV video signal using zero span, you will want to use the 5 MHz (maximum BW) filter to ensure enough bandwidth for the video signal. In other cases you may wish to select a very narrow resolution BW in order to resolve signal sidebands or intermodulation distortion products. The RES BW arrow keys enable you to select resolution BW's of 300 Hz, 3 kHz, 30 kHz, 300 kHz, and 5 MHz in the standard 2712 (Option 14 adds 1 kHz, 10 kHz, 100 kHz, and 1 MHz; Option 12 adds 1 kHz, 9 kHz, 120 kHz, and 1 MHz and replaces the 300 Hz filter with a 200 Hz filter).

Consider this: how far do signals have to be separated before we can see them as separate? The exact answer depends on the particular filters, bandwidths, signal levels and other factors, but two rules of thumb apply:

- If the signal amplitudes are less than 3 dB different, they are resolved when their frequency separation equals the resolution BW.
- For signals more widely separated in amplitude and frequency, let A be the amplitude difference. Then:

$$F = \left(1 + \frac{A}{22} \right) \times \text{resolution BW}$$

where F is the required frequency separation. This rule is based on the fact that the 2712's 60 dB filter bandwidths tend to be about 7 times the 6 dB bandwidth and assumes the filter roll-off is approximately linear in dB. Using this condition, if the signals are 30 dB different in amplitude, A , then they have to be separated by about $2.4 \times$ resolution BW.

Set the span to 2.0 MHz/. The resolution BW readout indicates 300 kHz. Let's see what happens if we change the resolution BW.

In the RES BW function block, press [▲].

The LED below the RES BW AUTO key went out indicating that the resolution BW is no longer being automatically selected, and the resolution BW readout indicates 5 MHz. What else happened? The calibration signal now appears to be 5 MHz wide! Theoretically, the cal signal should be infinitely narrow -- a spike at 100 MHz. To understand what has happened, you must recall the process going on within the analyzer. It is sweeping a narrowband signal (the calibration signal) past a broadband filter (the 5 MHz resolution filter). As the signal is moved past the filter, it maps the shape of the resolution filter. What you see is the spectral shape of the filter rather than that of the cal signal. The lesson is that, on unmodulated signals, a

resolution BW filter that is too wide can artificially broaden the displayed spectrum (although the signal peak remains accurate).

Did you also notice the noise floor increase 12 dB as you switched from 300 kHz resolution BW to 5 MHz? Do you know why? The noise coming through a filter is proportional to the filter bandwidth. For white noise at the analyzer input, the difference in noise power coming through two resolution BW filters with bandwidths RBW_1 and RBW_2 is:

$$\text{Noise Difference (dB)} = 10 \text{ Log} \left(\frac{RBW_1}{RBW_2} \right)$$

In this case;

$$10 \text{ Log} \left(\frac{5 \text{ MHz}}{300 \text{ kHz}} \right) = +12 \text{ dB}$$

more noise coming through a 5 MHz filter than through a 300 kHz filter.

Narrow the resolution BW by repeatedly pressing [↓] in the RES BW function block until the on-screen readout indicates 3 kHz. You hear a high level beep and see the message "UNCAL" (if you do not hear a beep, check that the audio alert is set to ERROR ONLY or BOTH -- see *The Audio Alert* in section 6). The analyzer is now sweeping the calibration signal past the resolution filter too quickly for the filter output to rise to its steady-state value before the signal is no longer present at the filter input. This can result in low amplitude and skewed frequency readings. The lesson is that resolution BW's which are too narrow can result in incorrect amplitude and skewed frequency measurements. Ultimate measurement accuracy is at risk when the "UNCAL" message is present.

Pressing the **AUTO** key in the **RES BW** function block toggles between operator and 2712 (automatic) selection of the resolution BW. When the resolution BW is being selected by the 2712, the LED below the key is lit.



Place the resolution BW in automatic mode by pressing **[AUTO]**. The red LED will be illuminated. You can take the analyzer out of **AUTO** mode by pressing a **RES BW** arrow key or by pressing **[AUTO]**.

Set the span/div to 50 MHz. Note the indicated resolution BW and, in the resolution BW function block, press **[↓]**. The LED has gone out and the resolution BW is 300 kHz.

Press **[AUTO]**. The LED comes back on and the resolution BW has switched back to 5 MHz.

Press **[AUTO]** again. The LED goes out but the resolution BW is still 5 MHz. Toggling out of **AUTO** mode with the **AUTO** key maintains the automatically selected resolution BW until you change it with a **RES BW** arrow key.

700.0MHz	(AUTO SWEEP)	ATTN 20DB
-10.0DBM		VF WIDE
50.0MHz/		10 DB/
5MHz RBW (AUTO)	CALIBRATOR	

A *video filter* is a post-detection filter (sometimes referred to as a *noise-averaging filter*) used to reduce noise in the displayed spectrum to its average value, making low-level signals more easily detectable. Normally, the 2712 uses a video filter about as wide as the resolution BW. This limits post-detection noise, but does not significantly alter the displayed amplitude of narrowband signals. However, if you must measure very wideband or pulse-like signals, you may wish to



use a filter somewhat wider than that automatically selected by the 2712. See *Menu-Entered Control Settings* and *Making EMI/EMC Measurements* in section 6.

The video filter width is indicated in the on-screen readouts by

VF (bandwidth)

where (bandwidth) is equal to the bandwidth of the video filter being used except in the case of the 5 MHz filter or the 1 MHz option 14 filter⁷. Then

VF WIDE

is substituted. In this case, the "filter" consists of the natural lowpass characteristics of the circuitry following the detector.

When you press the **VID FLTR** key, the 2712 automatically selects a narrower video filter bandwidth approximately 1/100 of the resolution **BW**⁷ (later you will learn how to specify a particular filter bandwidth via the Utility Menu). The narrow video filter dramatically reduces the noise and enhances the visibility of narrow band signals. Care must be taken, though, because it will also reduce the indicated amplitudes of wide band signals such as video modulation and short duration pulses.

To see the video filter work, ensure that the 2712 is set as in the preceding settings box. Can you see signal peaks at 700, 800, and 900 MHz?

Now press [**VID FLTR**]. The red LED below the key comes on indicating that a narrow video filter is being used, and the bandwidth of the filter is indicated on screen.

Notice how much less "noisy" the lower portion of the spectral display appears. By filtering the noise, it is sometimes possible to reveal low level signals that were in the noise. This is the primary reason for using a video filter. Now can you see signal peaks at 700, 800, and 900 MHz (the seventh, eighth, and ninth harmonics of the calibration signal)? There are small differences from instrument to instrument, but you should be able to spot the peaks above the noise.

⁷ Video filter settings for the EMC filters and QP detector (Option 12) may differ. See *Making EMI/EMC Measurements* and *Quasi-Peak Measurements* in section 6.

Video filtering works well for CW and other narrow band signals, but when examining pulsed or wide band signals such as television video (especially the sync pulses), a video filter may prevent you from accurately seeing signal characteristics in much the same way that using a too narrow resolution BW does.

Although it may not have been apparent, the sweep speed also decreased in order to accommodate the longer time constant of the video filter. Just as with the resolution BW filter, a signal needs more time to reach its peak amplitude when propagating through a narrow video filter.

Toggle the video filter off by pressing [VID FLTR] again.

100.0MHz	(AUTO SWEEP)	ATTN 6DB
-25.0DBM		VF WIDE
20.0MHz/		10 DB/
5MHz RBW (AUTO)	CALIBRATOR	

VERT SCALE

The VERT SCALE function block contains a three-way toggle key labeled 10/5/1.

This label expresses the three logarithmic vertical scale factors available on the 2712: 10, 5 and 1 decibels per major vertical division. Pressing the key advances the vertical scale factor through the three values in a 10dB - 5dB - 1dB - 10dB... sequence.

Press [10/5/1]. Two things happen. First, the signal peak is now one division down from the reference level. Second, the vertical scale factor on-screen readout now indicates 5dB/. The noise also seems to have disappeared, but this is fictitious. The signal to noise difference is the same, but the scale factor change has moved the noise below the bottom of the screen.

Again press [10/5/1]. The signal peak is five divisions down and the readout says 1 dB/. The primary use for this feature is to more accurately read displayed signal peaks. Press the key once again to restore the 10dB/ setting.

10/5/1

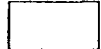

VERT SCALE

LIN



The second key in the VERT SCALE function block is toggle-action. It converts the vertical scale from logarithmic to linear and back again.

With the calibration signal centered and the reference level set to -25 dBm, press [LIN]. The vertical scale readout now indicates 1.57MV/. When LIN mode is initially selected, the 2712 converts the vertical scale such that the bottom graticule line is zero volts and the reference level is converted from dB's to voltage. The display is similar to what you see on an oscilloscope. Thereafter, the REF LEVEL arrow keys change the scale factor in a 1-2-5 sequence. Consequently, the reference level changes by 6 or 8 dB when changing scale factors. If the 1 dB reference level step size is selected while in LIN mode, the arrow keys change the scale factor at a rate of about 0.02 division per step and the corresponding reference level changes about 0.2 dB.

Experiment with the scale factor if you wish. Press [LIN] to toggle back to logarithmic mode. When switching back to logarithmic from linear, the last selected log scale is implemented.

100.0MHz	(AUTO SWEEP)	ATTN 0DB
-70.0DBM		VF 3KHz
50.0KHz/		10 DB/
3KHz RBW (AUTO)		

SWEEP



The SWEEP function block controls the 2712 sweep rate and single sweep feature (other trigger modes are

discussed in section 6 under *SWP/TRIG*). The rate at which the CRT beam sweeps across the screen is known as the sweep rate. It is also the rate at which the displayed spectrum is swept.

Normally, sweep rate is automatically selected by the 2712. However, in some cases, such as when looking at the time

domain representation of a signal in zero span, you may want to vary the sweep rate for a better view of the signal. Let's change the sweep rate now.

Ensure the calibrator is turned off and enter zero span mode.

The currently selected sweep rate is displayed on screen as the horizontal scale factor in zero span mode, and has units of time/division (in spectral mode, the sweep rate is viewed by pressing [SWP/TRIG]). The sweep rate readout indicates 100MS/ZSPAN (100 msec/div in zero span). You are looking at the internal noise. Now press [↓]. The LED below [AUTO] in the SWEEP function block goes out indicating the sweep rate is no longer being selected automatically.

Continue pressing [↓] until the sweep rate readout changes to 1MS/ZSPAN. The SWEEP down arrow key decreases the sweep rate in a 1-2-5 sequence.

The noise no longer looks like "grass". You can see variations in the noise waveform taking place in a millisecond or less, and even faster sweep rates are possible (1µsec/div) with display storage disabled.

Now press [↑] several times. The noise is compressed to a grass-like appearance and the indicated sweep rate increases. The SWEEP up arrow key increases the sweep rate in a 1-2-5 sequence.

The ↑ and ↓ keys perform reciprocal actions; they increase or decrease the time required to sweep one division. Pressing either key removes the 2712 from automatic sweep rate selection mode, and the ↑ or ↓ keys thereafter function like the sweep rate selector on a conventional oscilloscope.

NOTE

Because sweep rate is the inverse of sweep speed, *decreasing sweep rate increases sweep speed.*

Reset the sweep rate to 100 msec/div and the span/div to 50 kHz. Set the reference level to -10 dBm and turn on the calibrator. Reduce the time/div by repeatedly pressing [↓].

Again you hear a beep and the word "UNCAL" appears.

Continue to increase the sweep speed and notice the signal peak decrease and shift to the right.

This condition is achieved by sweeping too fast for a given resolution BW, and demonstrates how measurement errors can occur. You are sweeping the resolution filter so fast that its output does not have time to reach steady-state. **Reselect ZERO SPAN.** The UNCAL message disappears because in zero span mode the filter is not being swept at all.

Reset the displayed sweep speed to 1 msec/division.

SWEEP

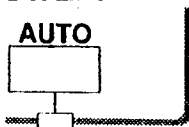

The **AUTO** key in the **SWEEP** function block serves two purposes. First, it is used in much the same way as the **AUTO** key in the **RES BW** function block, as a toggle-action key which switches the 2712 between automatic and manual selection of sweep rate. When **AUTO** sweep rate selection is active, the sweep rate selected by the 2712 depends on the span/div, resolution BW, and video filter in use. Second, pressing the **SWEEP AUTO** key when the 2712 is in single sweep mode, exits from that mode.

Continuing with the example above, press [ZERO] to exit zero span mode. Notice how distorted the calibration signal is and then press [AUTO] in the SWEEP function block.

The LED below the key lights indicating sweep rate is being automatically selected by the analyzer. The sweep rate is now 100 msec/division, the UNCAL message has disappeared, and the calibration signal is correctly indicated as -30 dBm at 100 MHz.

Again press [AUTO] in the SWEEP function block.

The LED goes out but the display doesn't change. Toggling out of **AUTO** mode maintains the automatically selected rate until you change it with the **↑** or **↓** keys.

Reactivate AUTO sweep mode.

100.0MHz	(AUTO SWEEP)	ATTN 20DB
-10.0DBM		VF 300KHz
1.0MHz/		10 DB/
300KHz RBW (AUTO)		

The 2712 is equipped with a single sweep feature. When activated by pressing [SINGLE], the analyzer makes only one sweep. Other controls (except [AUTO] in the SWEEP function block) operate normally, and signals at the input to the analyzer are treated just as they otherwise would be. Pressing [AUTO] in the SWEEP function block exits from single sweep mode.

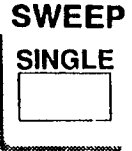

When a sweep begins depends on how the 2712 is triggered. The factory default mode is free run; this is the mode the analyzer should be in currently.

Set the resolution BW to 3 kHz. The sweep now takes two seconds. **At mid-sweep, press [SINGLE].**

The current sweep is aborted and this message appears on-screen under the right readout column:

SGLSWP MODE

The message means the sweep circuit is in single sweep mode and halted. **Press [SINGLE] again.** This prepares the sweep to begin as soon as it receives the next trigger signal (which occurs automatically in free-run mode). A message reading:

SGLSWP ARM

momentarily appears and a single sweep is carried out. You'll see the sweep progress across the screen as a new spectral display is created. When the sweep is completed, the SGLSWP MODE message reappears indicating the analyzer has completed the sweep and is ready to be re-armed.

If the 2712 is not in free run trigger mode (see **SWP/TRIG** in section 6 to change modes), behavior is much the same.

Pressing [SINGLE] causes the current sweep to abort and the SGLSWP MODE message to appear. If you press the key again, the SGLSWP ARM message appears. This time, however, the analyzer waits for the first designated trigger signal; when detected, a single sweep begins. After the sweep is complete the SGLSWP MODE message reappears.

You can start a new single sweep in any trigger mode as often as you wish by pressing [SINGLE] after the SGLSWP MODE message appears. However, if you press [SINGLE] too soon, you may exit from single sweep mode.

To exit from single sweep mode, press [AUTO] in the SWEEP function block, or change the sweep rate.

Single sweep mode is useful when you want to prevent a succeeding sweep from overwriting a trace you just acquired, or to capture the characteristics of intermittent signals.

LEVEL

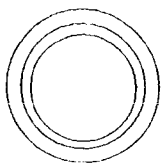

There is a dual-concentric-shaft LEVEL control below the FREQ/MKRS knob. The inner knob controls the triggering level when the 2712 is in internal, external, or line trigger modes, just as the equivalent control does on a conventional oscilloscope. In the other trigger modes it has no effect. The inner knob is also used to control the TG variable amplitude setting when Option 04 (Tracking Generator) is installed.

The outer knob controls the volume of the AM and FM demodulators, and the horizontal sweep position in manual scan mode. It also controls picture framing when the video monitor (option 10) is present.

Alternate uses of the LEVEL control are discussed under **DEMOD/TG** and *Manually Scanning* in section 6.

100.0MHz	(AUTO SWEEP)	ATTN 20DB
-10.0DBM		VF 300KHz
5.0MHz/		10 DB/
300KHz RBW (AUTO)	CALIBRATOR	

DISPLAY STORAGE

The 2712 can display an analog spectrum or up to four sampled and

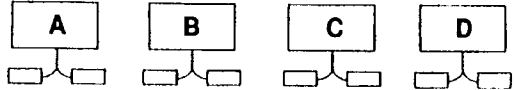

stored digital spectra. A major advantage of display storage is that it results in a flicker-free sweep. The digital display storage registers are named A, B, C, and D. Their status is controlled by [A], [B], [C], and [D]; the red and green LED's below each key indicate the status of the corresponding register. When a red LED is lit, the contents of the corresponding register are displayed. The contents of a register can be either the measurement currently being carried out, or previously saved data.

When only a red LED is lit, the contents are the result of the analyzer's current activity. Current results are updated from the signal at the analyzer input during each sweep. The present control settings are used for the update.

When an A, B, or C green LED is lit, the corresponding register contains a saved sweep (the on-screen readouts are saved along with the sweep). A saved sweep cannot be erased, modified, or updated without operator interaction.

When the D green LED is lit, the 2712 is in "waterfall" mode.

[A], [B], [C], and [D] are toggle-action keys that activate and deactivate the display registers. A register's contents are displayed only when it is activate (red LED lit), although it still contains saved data as long as its green LED is lit.

Turn on the C register by pressing [C].

Did you notice any changes after pressing [C]? The only change that might be apparent is an increase in intensity since the 2712 is now displaying the C trace on top of the D trace.

Now turn on the A and B registers by pressing [A] and [B].

Again, you may notice an increase in intensity, but the shape of the spectral display should not change because each register contains exactly the same information. Deactivate the B, C, and D registers by pressing [B], [C], and [D].

This display is no different than the D register waveform. Verify this by turning on the D register and turning off A (press [D] and then [A]). Verify that this is true of the other registers by alternately switching a new one on and the previous one off.

ANALOG DISPLAY

Deactivate all registers. What happened? You are now looking at the analog output of the analyzer. Note its similarity to the MAX/MIN display. Any time all four red LED's are extinguished, the analog output of the 2712's detector is displayed (see also *Analog/Digital* in the next section). The digitizer is still working; you have just disabled all the display registers. The analog display can be very useful for viewing time-varying modulation such as television video signals. It is also useful if you are graduating from an older analyzer which may not have digital display capabilities; it provides a display you are familiar with and allows you to see the similarity between the 2712's MAX/MIN display and the analog signal. You can usually obtain a "crisper" analog display, especially at higher sweep speeds, by varying the intensity (see *INTENSITY* at the end of this section) and/or by turning off the on-screen readouts.

Activate the D register.

DISPLAY STORAGE

The **SAVE ENABLE** key modifies the function of the **A**, **B**, **C**, and **D** keys. When used with **[A]**, **[B]**, or **[C]** it enables you to save the current digitizer output in the corresponding register.

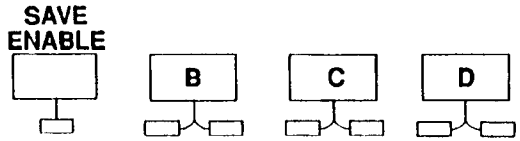

To see how this works, press **[SAVE ENABLE]**. The red LED below **[SAVE]** lights. This indicates that the **SAVE** function is "armed".

To save in the **A** register what is presently being displayed, press **[A]**. The green LED below **[A]** lights, but observe that the **A** register was turned off and remains turned off. Turn off the **D** register and turn on the **A** register. Notice that the display does not change with time. The contents of the **A** register are not being updated. You are viewing a saved sweep.

Now let's save something in **B**. Activate the **B** register and ensure the **A** register is turned off. Set the resolution **BW** to 30 kHz. Press **[SAVE ENABLE]/[B]**.

The current sweep is saved and the **B** green LED lights. The register remains active, but because it is now saved, it is no longer updated.

NOTE

Status of the red LED is not changed by the save operation.

Deactivate all registers (all red LED's extinguished). Set the resolution **BW** to 5 MHz and press **[SAVE ENABLE]/[C]**. The **C** green LED lights, but what has been saved? Activate the **C** register. You see the digitized and saved version of the analog sweep. The digitizer is continuously updated, whether it is being displayed or not. Further, it is always the current digitizer output that is saved. You cannot, for instance, save one register into another. However, non-volatile RAM does make it possible to permanently save the contents of the display registers by transferring them to stored settings registers (see *OTHER USER-DEFINED SETTINGS* in the next section).

Now deactivate the C register and activate A. How do you clear the register? You do the same thing you did to store a waveform. Press **[SAVE ENABLE]/[A]**. The A green LED goes out indicating there is nothing stored in the A register. The register remains active, but the displayed spectrum is now updated during each sweep.

REGISTER PRIORITY

Did you notice that the on-screen readouts are stored along with the sweep? Unfortunately, the analyzer can only display one group of readouts at a time. When multiple registers are active, the readouts for the highest priority register are displayed. Register priority is shown below.

PRIORITY	REGISTER
highest	D-register, current waveform
:	C-register, current waveform
:	B-register, current waveform
:	A-register, current waveform
:	D-register, saved waveform
:	C-register, saved waveform
:	B-register, saved waveform
lowest	A-register, saved waveform

To see how register priority works, let's view some spectra. Turn off A and turn on B. Note the on-screen readouts. The indicated resolution BW should be 30 kHz. Now turn on C. The resolution BW should read 5 MHz (C has a higher priority than B, so its readouts are displayed). Turn on the A register and set the resolution BW to AUTO. Notice the RBW readout change. Any register containing a current sweep has a higher priority than a register containing a saved sweep, so the A-register readouts are now displayed.

Do you have a better understanding of which display the on-screen readouts apply to? Experiment more, if you wish, then clear and deactivate the B and C registers. Leave only the D register active.

100.0MHz	(AUTO SWEEP)	ATTN 40DB
10.0DBM		VF 300KHz
5.0MHz/		10 DB/
300KHz RBW (AUTO)	CALIBRATOR	

DISPLAY STORAGE

The **SAVE ENABLE** key also changes the function of the D key. When used with [D], it places the 2712 in "waterfall" mode (symbolized by the  icon below the D key). This waterfall display is more effective in peak acquisition mode (which will be discussed under **DSPL** in the next section).

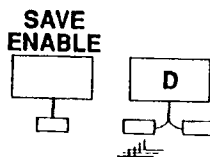

Press **[DSPL]/[4]** to enter peak acquisition mode Press **[SAVE ENABLE]/[D]** to enter waterfall mode.

All eight of the register status LED's light and four traces appear. Because waterfall mode uses all four registers, A, B, and C registers must be cleared before the 2712 allows you to enter waterfall mode. This is a safeguard to prevent accidental overwriting of previously saved data. If you attempt to enter this mode without first clearing the registers, you receive an error message.

Look at **Figure 5-1**. D is the bottom waveform and A the top. Each waveform is displaced upwards one division from the preceding waveform, and shifted 1/2 division to the right. The most recent (current) sweep is in the D register, the previous sweep in C, the next previous in B, and so on. At the end of each sweep, the waveforms are all shifted up one register. This display can be used to watch slowly varying spectra evolve or to obtain a "feel" for the variability of signals. Waterfall can also be useful for "catching" an event which occurs quickly. In the present case of the calibration signal, you will observe that there is virtually no variation.

Create a small signal shift by slightly changing the center frequency. See how the waterfall mode records the shift?

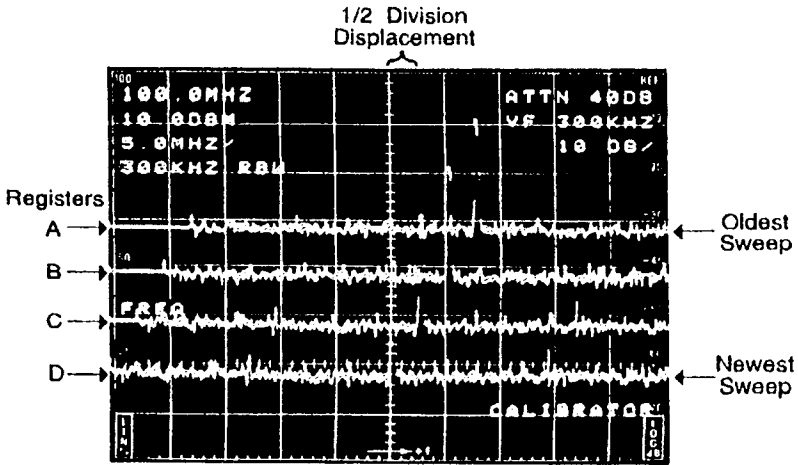

Figure 5-1. Example of a waterfall display.

You can halt the waterfall action at any time by pressing [SGL SWP]. Thereafter, each time you press [SGL SWP] the waterfall will advance one trace. Exit normally from single sweep mode to continue the waterfall display.

You do not have to view all the traces. **Turn off the A and C registers. Turn off B and D and turn A and C back on.** You can view any, all, or none of the registers. Turn them all off and the analog display reappears. However, the analyzer is still in waterfall mode. You cannot selectively erase a register or store new data in it without first exiting from waterfall mode.

Turn on all registers. Exit from the waterfall display mode the same way you entered it; press [SAVE ENABLE]/[D].

All LED's except the red D go out and the waterfall display collapses to a single D register trace.

Reset the center frequency to 100 MHz. Return to MAX/MIN acquisition mode by again pressing [DSPL MENU]/[4].

DISPLAY STORAGE

The A and B registers can be used in MAX HOLD mode to save the peak values of measured spectra. The register must be cleared before you can use it in MAX HOLD mode.

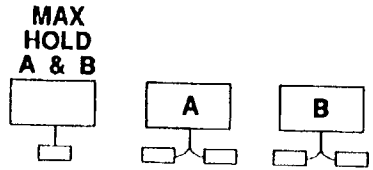

The MAX HOLD feature compares the amplitude of the current sweep, point for point, with the stored maximum value of previous sweeps. If the current amplitude is greater, the current value becomes the new stored maximum; if not, the previous value is retained.

Deactivate the D register. Make sure the A register is cleared and activated, then press [MAX HOLD A & B].

The red LED below the MAX HOLD key lights signifying that you have entered the MAX HOLD mode. The spectral display, especially the noise is much smoother. If you wait several minutes, you'll notice the noise floor appears to drift upwards a couple of dB. Because the calibration signal is constant, you don't notice any change in it. The upward drift of the noise floor slows and stops as the most likely maximum values are observed and stored. Now only an occasional noise peak exceeds the previously stored values. Activate the D register. Observe how the waveform in the D register (waveform without MAX HOLD) is always less than the A register waveform. Recording the peak signal excursions observed during a large number of sweeps using the MAX HOLD feature yields an estimate of the maximum signal values. It can also be very useful for determining maximum signal amplitude during transient conditions, or for making low-level fluctuating signals more apparent by saving their peak value. You can observe as many sweeps as you wish. You could equally as well have used the B register for MAX HOLD.

When you are ready to exit the MAX HOLD mode, press [MAX HOLD A & B] to turn off the A register. The red LED goes out and only the register D sweep remains.

A capability called MIN HOLD, similar to MAX HOLD, saves the minimum signal values. Using both MIN HOLD and MAX HOLD, you can measure a signal's total excursion. For details, see the **DSPL** discussion in the next section.

FREQ/MKRS

MKR/Δ
/OFF

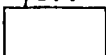

Marker-Delta-Off key (MKR/Δ/OFF) is a three-way toggle switch which enables you to control one, or apair, of markers. A marker is a bright spot which appears on the digitized waveform. Markers cannot be used with the analog display. When marker mode

is turned off, the spot on the display indicates either the center or starting frequency of the display. When a single marker is turned on, it can be moved to any point along the displayed waveform using the FREQ/MKRS knob. The corresponding signal amplitude and frequency is displayed on screen. The marker amplitude readout represents the most accurate method for determining signal amplitude with the 2712 (unless a separate extremely precise signal is used for direct comparison). In general, amplitude accuracy is further enhanced if the signal being measured is first moved to within one division of the top graticule line using the REF LEVEL controls.

In delta (Δ) marker mode, two markers designate the points on the waveform between which the differences in signal amplitudes and frequencies are measured and displayed. It is not possible to display one marker on a particular trace while displaying the second marker on another trace. More than one register can be displayed, but the markers appear only on the highest priority waveform.

To activate the marker, press **[MKR/Δ/OFF]**.

The sweep does not change, but the RF attenuation and video filter readouts have changed to (approximately):

M 100.0MHz
M -30.0DBM

The **M** preceding the first two items in the right-hand on-screen readouts represent the amplitude and frequency of the signal at

the marker position. Turn the **FREQ/MKRS** knob several clicks clockwise. The marker moves to the right and the readout tracks it. The knob now controls the marker position rather than the center frequency. Move the marker into the noise. Notice that the marker actually moves up and down between the max and min noise values on alternate clicks of the knob. This is because each click of the knob moves the marker to the next bin in the digital waveform memory, thus tracking the stored max and min values. Turn the knob counter-clockwise and the marker moves left. Again, the readout tracks the signal amplitude and frequency at the marker position. Be aware that the marker frequency accuracy is not as good as the center frequency accuracy (see *CTR-MEAS/TRKG* later in this section for a discussion of frequency measurement accuracies) because it includes a span nonlinearity component.

If you attempt to move the marker past either edge of the display, the spectrum will move towards the opposite edge while the marker remains stationary. **Try moving the marker past the right edge. See how the signal peak moves to the left. Now turn the knob a few clicks counter-clockwise. The marker moves to the left but the spectrum will not move back towards its original position until you attempt to move the marker past the other edge of the display. Go ahead and re-center the calibration signal peak by trying to move the marker past the left edge of the display.**

Ensure the marker and the calibration signal peak are centered. Again press **[MKR/Δ/OFF]**.

The spectral display did not change, but the first two items of the right column now read:

D 0KHz
D 0.0DB

You have turned on the delta-marker mode. **Turn the tuning knob clockwise.** Now you can see both markers. One remains at the original marker position while the position of the second is controlled by the knob. The right column indicates the

difference (denoted by the letter D preceding the readouts) in frequency and amplitude between the two marker positions.

Increase the span to 50 MHz/division. Use the tuning knob to place the movable marker at the top of the first signal peak to the right of center (the calibration signal second harmonic). The right column now reads (approximately):

**D 100MHz
D -13.0 DB**

You are measuring the difference in frequency and amplitude between the fundamental and second harmonic of the calibration signal. Your instrument may not read these values exactly, but it should be close.

If you attempt to steer the movable marker past the edge of the display, you'll see that the spectral display behaves almost the same as it did for the single marker. The difference is that the stationary marker remains fixed with respect to the spectrum. You can even force the stationary marker off screen and the readout will continue to indicate the difference between the two marker positions. In this way you can make difference measurements across the whole input range of the analyzer.

Turn the tuning knob clockwise until the readout indicates the movable marker is 900 MHz to the right of the stationary marker. Can you see the sixth or seventh harmonics of the calibration signal near center screen? If not, turn on the video filter. You should now see the peaks. Place the moveable marker on either peak to measure its difference in amplitude and frequency relative to the fundamental.

Toggle out of marker mode by pressing [MKR/Δ/OFF] until the normal RF attenuation and video filter readouts return (one press if in Δ-marker mode, two if in single marker mode).

Turn off the video filter.

140.0MHz	(AUTO SWEEP)	ATTN 10DB
-20.0DBM		VF WIDE
50.0MHz/ 5MHz RBW (AUTO)	CALIBRATOR	10 DB/

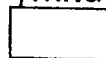
FREQ/MKRS**CTR-MEAS****/TRKG**

The center measure feature detects the signal peak nearest the marker and above a preset amplitude threshold (changing the threshold is discussed in section 6 under the **MKR/FREQ**).

When the marker is turned off, the signal peak nearest center screen is used. The analyzer then measures the signal frequency and makes it the new center frequency.

This feature means that you don't have to play finicky games with the tuning to measure a signal frequency. All you have to do is place the marker close to the signal of interest and press the center measure key! Press the key twice to enable the signal track feature which keeps drifting signals centered by continuously repeating the center measure feature.

NOTE

[CTR-MEAS/TRKG] provides the easiest and most accurate method of determining a signal's frequency.

To use the center measure feature, turn on the marker and place it near the calibration signal using the **FREQ/MKRS** knob (In general, place the marker near the signal of interest. If you do not turn on the marker, the signal nearest center screen is measured). Set the reference level so the signal peak is within one division of the top graticule line and press [CTR MEAS/TRKG].

The calibration signal is recentered and, the amplitude and frequency of the centered signal are read out at the upper right of the screen preceded by a "C" (counter). The counter readout provides the most accurate frequency determination available on the 2712 and its resolution can be set to 1 Hz if desired. The counter readings disappear when a control setting is altered.

The marker and counter amplitude readouts are equally accurate. However, the signal amplitude indicated by the position of the marker relative to the graticule may differ slightly from the readout. The readout is more accurate because it contains no display nonlinearities.

The center frequency and counter measurements are equally accurate, but in general the counter readout is more precise. Frequency accuracy is:

$$\pm 5 \times 10^{-7} \text{ of center frequency} \pm 10 \text{ Hz} \pm \begin{matrix} \text{least} \\ \text{significant} \\ \text{digit} \end{matrix}$$

Now let's look at the calibration signal third harmonic more closely. **Place the marker near the third harmonic, say about 280 MHz, and press [CTR MEAS/TRKG].**

The calibration signal third harmonic is made the new center frequency and its frequency and amplitude are displayed at the top of the right-hand readouts.

Now enter delta-marker mode. Place the movable marker near the calibration signal fundamental (at 100 MHz) and press [CTR MEAS/TRKG].

This mode of operation centers the signal peak nearest the movable marker and measures the difference between the centered signal and the signal at the fixed marker. In this case, the fundamental is re-centered and the markers appear atop it and the third harmonic. Readings of approximately 200 MHz and 12 dB appear at the top of the left column preceded by the letters DC (delta-counter). The center measure feature with delta marker mode provides a very convenient method of determining precise signal differences without manual tuning or interpolation of graphical data.

Turn off the markers.

The center measure feature can perform still another function. When center measure is used in zero span mode, the counter measures the frequency at the output of the 2712 detector. Because the output varies only if the signal is modulated, the

counter is actually measuring the frequency of the modulation (if none is present, you receive a message saying so). Normally AM detection is used, but you can select FM detection (see *Viewing Instantaneous Frequency Deviation* in section 6). Whichever detector is selected, the center measure feature provides a quick method of determining the frequency of the modulating signal. Of course, the modulation frequency must fall within the bandwidth of the resolution BW filter and any video filter which is active (and the FM discriminator when FM detection is selected).

100.0MHz	(AUTO SWEEP)	ATTN 10DB
-20.0DBM		VF WIDE
20.0MHz/		10 DB/
5MHz RBW (AUTO)	CALIBRATOR	

The signal track feature of the 2712 continuously repeats the center measure operation. On each sweep the signal nearest midscreen is remeasured and recentered. This is useful for keeping a slowly varying or jittering signal centered for close observation.

To activate signal track, press **[CTR MEAS/TRKG]** twice.

The term "TRKG" appears in center screen indicating that the 2712 is in signal track mode.

Try turning the tuning knob while a sweep is underway.

On the next sweep you may see the signal displaced a bit, but on the following sweep it is recentered. You will also notice the frequency readouts change. Tracking mode continuously repeats the center measure feature.

If the signal being tracked falls below a preset threshold (see *Setting the Signal Threshold* in the next section), tracking halts and this message is displayed:

NO SIGNAL FOUND ABOVE THRESHOLD

The message is accompanied by a beep. When the signal rises back above threshold, signal track resumes automatically.

Simulate signal loss and recovery by turning the calibrator off and then back on again. The audible beep makes this signal track mode useful as an amplitude threshold detector.

You can also obtain continuous counter readings in signal track mode. Press **[MKR/FREQ]/[9]/[2]/[2]** to turn on the counter (See *Counter Resolution* in section 6 for additional information).

Now let's continuously monitor a frequency difference. Press **[CTR MEAS/TRKG]** again to exit from tracking mode. Reset the span to 50 MHz/division and enter the delta-marker mode. Place the movable marker near the third harmonic. Re-enter tracking mode. You are using the delta-counter feature in signal track mode. The third harmonic is centered and the frequency difference between the fundamental and third harmonic is being constantly monitored, just like that!

Exit from tracking mode and turn off the markers.

FREQ/MKRS

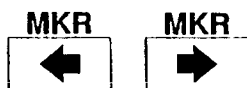

Center the calibration signal and turn on the marker. Press **[MKR →]**. The

marker jumps to the second harmonic peak. Press the key again. It jumps to the third harmonic.

Now press **[MKR ←]**. The marker jumps in the other direction. **[MKR ←]** and **[MKR →]** move the marker to the next signal peak in the indicated direction and above the preset threshold, but they will not go beyond the edge of the display or lower than 0 Hz. Further, the readouts and center measure/tracking behave as if you'd manually moved the marker.

Enter delta-marker mode and try pressing the arrow keys.

The movable marker jumps in the direction of the arrows just as the single marker did, and the readouts and center measure/tracking behave as if you'd manually moved the marker.

FREQ/MKRS

Ensure the markers are turned off. Set the center frequency to 275 MHz and press **[PEAK FIND]**. The marker automatically turned on and jumped to the peak of the calibration signal at 100 MHz.

**PEAK
FIND**

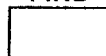

The 2712 detected the highest signal on screen and automatically moved the marker to it. After the move, the analyzer behaves exactly as if you had moved the marker there manually.

Use **[MKR →]** to move the marker to the peak of the third harmonic. Press **[PEAK FIND]** again. The marker moves back to the fundamental; the marker peak find feature always locates the highest peak on screen.

Any control Settings can be used

MISCELLANEOUS CONTROLS

We have discussed and experimented with all the 2712 functions except the menu keys and a few miscellaneous controls. These controls will be covered briefly here.

Immediately below the VERT SCALE function block there is a PLOT key which causes an optional printer or plotter to draw an image of the screen.

PLOT

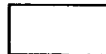

The on-screen readouts are plotted on the drawing in the border area so they don't interfere with the waveform. If you wish to have graticule lines on the printout, you must turn them on by pressing **[UTIL]/[4]/[1]/[5]**. You can also add labels to the plot (see *Adding Titles and Labels* in section 6).

Before attempting to create a screen plot, you must ensure that the 2712 communications port is correctly configured (see *System Configuration* in the next section).

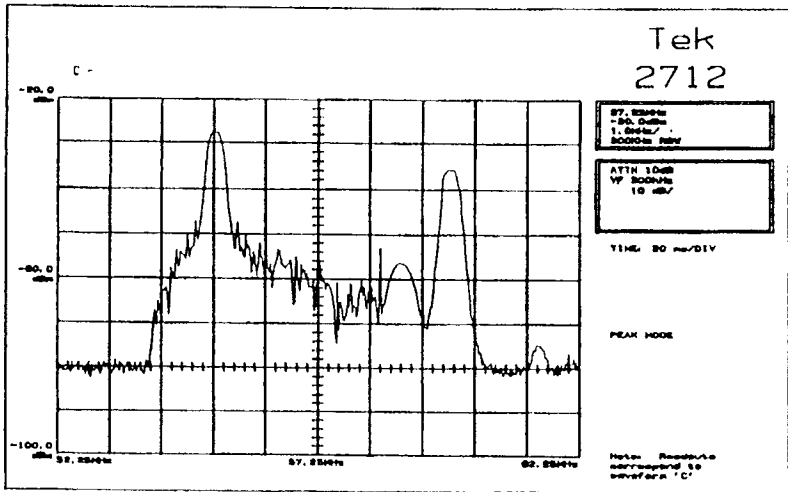

Figure 5-2. Typical plotter output from the 2712 showing a cable television spectrum.

To make a plot of the screen, check that your printer or plotter is powered up, on line, and that the paper is in correct registry. Then, with the 2712 displaying the desired trace(s), press [PLOT].

The printer or plotter quickly begins to draw the trace. Because the printer/plotter output data are buffered, the analyzer returns to the spectral display and is ready to accept additional commands before printing/plotting ends. A typical plot is shown in Figure 5-2.

NOTE

Plotting time can be reduced by choosing peak acquisition mode, or using the video filter, to reduce noise variations. Noise variations do not affect printing time when using a dot-matrix printer.

READOUT

You can toggle the standard on-screen readouts on and off. There are two reasons for doing so. First, it prevents the readouts from overlapping the signal spectrum.

To understand the second reason, initialize the 2712 to the factory power-up defaults and enter analog display mode. Notice the regularly spaced dark areas in the sweep. Now turn off the readouts by pressing [READOUT] below the VERT SCALE function block.

The dark areas are gone now. The dark areas represent time when the CRT beam is writing the on-screen readouts. Their appearance changes with sweep speed. By eliminating the readouts, you eliminate the dark areas. You will also notice that the trace has intensified. This is because the analyzer does not have to take time out from each sweep to write the on-screen data. The added intensity can be important when viewing analog data at high sweep speeds.

Turn the data readouts back on by again pressing [READOUT] and activate register D.

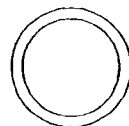
INTENSITY

The intensity control is a rotary knob that works exactly like any other oscilloscope intensity control. **Twist the INTENSITY knob slowly back and forth. Notice the display grow brighter and dimmer as you turn the control.** Leave the intensity set to a level sufficient for good contrast in your ambient light conditions. If you have to turn it to full intensity, try reducing the ambient light or shielding the display. **If the 2712 is used in direct sunlight, a contrast-enhancing filter is recommended (part of Option 33).**

**TRACE
ROT****VERT
POS****HORIZ
POS**

There are three non-locking slotted controls at the upper right of the 2712 rear panel which are used with a built-in test display to adjust trace

alignment. The control shafts are recessed within hex nuts which attach the controls to the analyzer chassis. Do not attempt to turn the hex nuts and do not use excessive force when turning the slotted shafts. A plastic "tweaking" tool is recommended in preference to a screwdriver. Display alignment instructions, utilizing these controls, are located in the Utility Menu portion of the next section.

SECTION
6

SOFTWARE
CONTROLS

SECTION 6

SOFTWARE CONTROLS - THE MENUS

This chapter describes in detail the menu-selected, software-driven features of the 2712. You will discover how this approach to instrument control provides a degree of measurement flexibility otherwise unattainable without a large, cumbersome, and hard to understand control panel.

If you glance at the front panel of the 2712, you'll notice a function block labeled **MENUS**. Pressing the keys in this block *calls up*, or causes to be displayed on the screen of the 2712, a *menu*. The menus enable you to perform a variety of tasks, some of which are not convenient using the front-panel dedicated controls. These include:

- Controlling spectrum analyzer operational modes
- Changing control increments and settings
- Storing and recalling control settings
- Normalizing the spectrum analyzer
- Altering measurement parameters
- Executing diagnostic routines
- Automating measurements

Each menu is a list of numbered items. Choosing an item often results in a secondary menu being displayed. Some infrequently used items from the secondary menu may call up a tertiary menu. A few items from the menus are neither listed nor explained in the following discussions: these are absent from the instrument itself, or represent factory troubleshooting and calibration aids not intended for general operator use.

An overview of the menus is included in the *Operation Summary* section. Once you've familiarized yourself with the menu features, the overview should provide all the information you need to use the menus effectively.

To use the menus, first press the appropriate menu key in the **MENUS** function block, and then simply press the number key on the keypad corresponding to the desired item.

INPUT MENU	
1 PREAMP	OFF
2 50 OHM DBM/75 OHM DBMV	50
3 REF LEVEL UNIT	DBM
4 1ST MXR INPUT LEVEL	-30DBM
5 RF ATTENUATION	AUTO 50DB
6 EXTERNAL ATTEN/AMPL	NONE
9 CAL SIGNAL @ 100MHz -30DBM	OFF
PRESS ANY MENU KEY TO EXIT PRESS BKSP FOR PREVIOUS DISPLAY	

Figure 6-1. The Input Menu.

A *feature status indicator* on the right side of the menu item shows the present value or condition of that parameter or feature. See Figure 6-1 as an example. The status indicator is updated as you make selections or alter parameters.

Depending on the parameter or feature, there are three ways the status may be changed. Each uses the 2712's numeric keypad:

- When only two or three values or conditions are permitted, pressing the keypad key corresponding to the item number cycles through the acceptable values. At each step, the new status appears at the end of the line.
- If the 2712 accepts a larger but still limited range of values, it presents a secondary menu consisting of a list of the values that may be selected by pressing their corresponding keypad key. For instance, if you select item 3 from the Input Menu shown in Figure 6-1, the Reference Level Units Menu shown in Figure 6-2 appears. An asterisk inserted between the item number and its description indicates the value presently selected.
- If a parameter can have a wide range of numerical values, two things happen. First, the analyzer precedes the selected item number with an asterisk (to ensure there is no confusion about which item was selected). Then the 2712 produces a prompt near the bottom of the screen indicating that you should enter the new value. This is illustrated in Figure 6-3 where item 6 from the SWP/TRIG Menu has been selected.

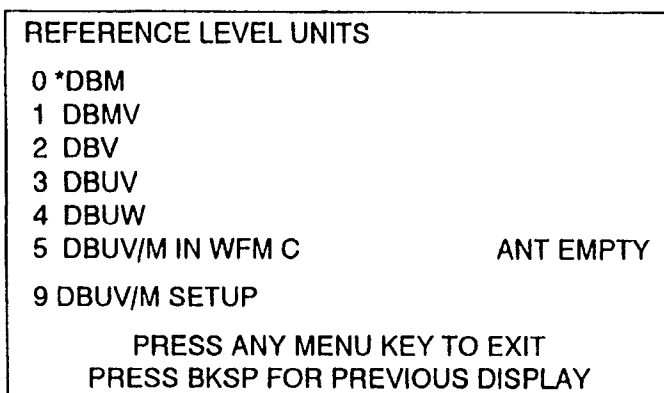

Figure 6-2. Reference Level Units Menu.

To enter a setting or parameter value, you press the sequence of number keys representing the numerical value, and then press the appropriate terminator key. The numbers appear on screen as you type them, but are not entered until you press the terminator key.

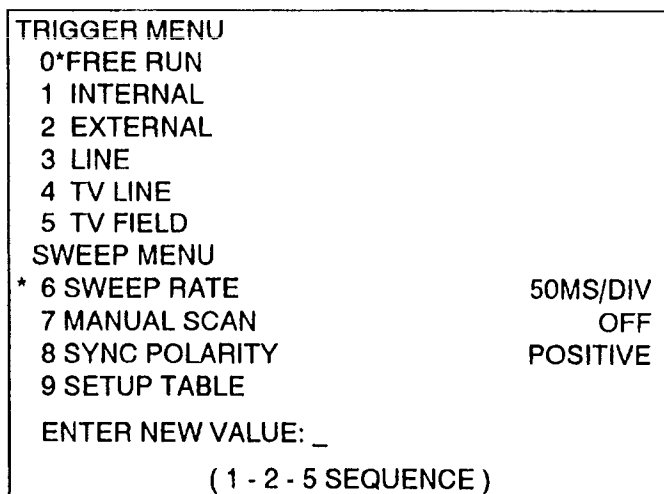

Figure 6-3. Sweep/Trigger Menu with SWEEP RATE selection chosen.

If you make a mistake, you can correct it any time prior to pressing a terminator by repeatedly pressing [BKSP] (the backspace key) until the incorrect number disappears, and then typing the correct value.

The terminator keys ([W], [X], [Y], [Z]) determine the units and enter the data. Each key can represent several units, but they are context-sensitive and the 2712 will determine the intended unit based on the parameter or setting you are attempting to modify. For instance, [X] can represent MHz, mSEC, or mV, but if you are attempting to enter a sweep rate, the 2712 will correctly interpret the units as mSEC when you press [X].

Thus, to enter a value of 20 milliseconds, you would press:

[2]/[0]/[mSEC] or [2]/[0]/[.]/[0]/[mSEC]

Whereas to enter 20 microseconds instead, you would press:

[2]/[0]/[μSEC] or [2]/[0]/[.]/[0]/[μSEC]

Note that entering a value for the sweep rate also removes the sweep rate parameter from automatic selection by the analyzer itself. To return to automatic selection, you press [AUTO] in the SWEEP function block.

There are three ways to exit from a menu:

1. Many selections cause the analyzer to revert automatically to the measurement mode it was in before calling up the menu. A small delay is provided between making the selection and reverting to the spectral display to enable you to see the status indicator at the end of the menu line change. However, the change is also reflected in the on-screen readouts in many cases, or by the nature of the spectral display itself.
2. This prompt is displayed at the bottom of all menus prior to making a selection:

**PRESS ANY MENU KEY TO EXIT
PRESS BKSP FOR PREVIOUS DISPLAY**

Simply pressing a menu key returns instantly to the spectral display. You can use this technique also if you decide not to make a selection.

3. Pressing the backspace key, [BKSP], returns to the previous menu. If there is no previous menu, you return to the spectral display. The backspace key can, therefore, be used to return to a previous menu to alter a selection, or to back entirely out of a menu and return to the spectral display.

In general, menus are not reproduced here. It is intended that you call up menus on the 2712 and follow along with the experiments in this section as they are described. However, should you need a handy reference, consult section 4, *Operation Summary*.

100.0MHz	(AUTO SWEEP)	ATTN 10DB
-20.0DBM		VF WIDE
20.0MHz/		10 DB/
5MHz RBW (AUTO)		

The Input Menu is used to control analyzer parameters which alter signal sensitivity, change measurement amplitude units, and turn the calibration signal on and off.

INPUT

To call up the Input Menu, press:

[INPUT]

The menu shown in Figure 6-1 appears on screen.

Turning the Calibrator On and Off

The word OFF following item 9 of the Input Menu indicates the 2712 calibration signal is turned off. **Turn on the calibration signal by pressing [9].**

The spectral display reappears and the word CALIBRATOR is now displayed at the lower right of the screen indicating the calibration signal is on. The calibrator signal is the peak at center screen. Turning on the calibrator also internally disconnects the normal analyzer input from the RF attenuator and prevents viewing external signals.

Again press **[INPUT]**.

The word following item 9 now is **ON**. In this way, the menu enables you to toggle between the two possible settings, and appraises you of the current setting.

Turn the calibrator off by pressing keypad key **9** again.

You get the spectral display back but without **CALIBRATOR** displayed. Press **[INPUT]/[9]** once again to turn the calibrator back on.

Setting the RF Attenuation

Set the reference level to 0 dBm (**[REF LEVEL]/[0]/[+dBx]**). Press **[↓]** to the right of **[REF LEVEL]** twice. Notice that the signal peak rises but the noise floor does not.

This is because the RF attenuation is decreased each time you pressed the key; the increased signal height is achieved by reducing attenuation. The analyzer noise floor, however, is generated after the RF attenuator, so it is not affected.

Reset the reference level to 0.0 dBm and select the **Input Menu**.

Item 5 informs you that the RF attenuation is 30 dB and that it is selected automatically by the 2712. We can control the RF attenuation so that it remains at a fixed value.

Select item 5 and this prompt appears:

```
ENTER NEW VALUE OR "W": __
( 0 TO 50 IN 2 DB STEPS )
W = AUTO
```

Enter a fixed value of 30 dB by pressing:

[3]/[0]/[+dBx]

The display returns unchanged. Again press **[↓]** twice. Now the signal peak and the noise floor both rise. This is because

pressing the [\blacktriangledown] key twice increased the analyzer IF gain by 20 dB to lower the reference level, but the RF attenuation is unchanged.

Press [INPUT]/[5]/[W] to place the RF attenuation back in automatic mode.

Changing Reference Level Units

You can change the reference level units via the Input Menu. **Ensure the reference level is set to 0.0 dBm and then choose item 3 from the Input Menu.**

A list of six possible units appears. **Select item 2, dBV.** The spectral display is restored but the reference level now reads -13.0 dBV because 1 mW across 50 ohm (0 dBm) represents .223 volts which is 13 dB below a 1 volt reference (0 dBV). Only the units change, not the analyzer gain, attenuation, or input impedance. Therefore, the height of the spectrum is unchanged.

Change the units back to dBm and turn off the calibrator.

Each of the six units except the DBUV/M (dB relative to a μ Volt per meter) represents a simple change of scale. Be aware that the 2712 always measures the voltage at its input across its 50 ohm input impedance, and then scales the result according to the selected units. Because the DBUV/M is not just a simple unit conversion, it is discussed separately in a later section.

Accommodating External Amplification/Attenuation

When you wish to measure a high amplitude signal, it is possible that you will have to attenuate the signal before inputting it to the spectrum analyzer. (Remember, the maximum total signal power at the input to the 2712 should not exceed +20 dBm, or 100 mW.) On the other hand, if you have a very weak signal, you may need to amplify it. You could mentally add the extra attenuation or amplification to the displayed signal peak to determine the correct signal amplitude, but the 2712 has a better way.

Ensure the calibrator is turned off and select the **Input Menu**. Item 6 tells you there is presently no external attenuation or amplification. Select **item 6**. A secondary menu appears which enables you to enter the amount of external attenuation or amplification. Select **item 1**. Suppose you've attenuated an **RF transmitter output 40 dB** prior to measuring it. Following the on-screen prompts, press:

[4]/[0]/[-dBx]

This procedure enters an external attenuation value of 40 dB. The spectral display does not change, but the reference level now indicates 40 dBm and is followed by the term:

OFST

indicating that the reference level has been offset, in this case by 40 dB. The reference level is offset automatically when you enter any value for external attenuation or gain.

To turn off the offset, first press:

[INPUT]/[6]

Item 0 tells you the offset is turned on. Turn it off by selecting **item 0**. The spectral display will reappear, but **OFST** is gone.

Toggle the offset back on without recentering the external attenuation value by pressing:

[INPUT]/[6]/[0]

Now turn off the offset, and then enter a value of 0 dB for external attenuation.

Accommodating a 75 Ohm Source

The 2712 has a 50 ohm input impedance and expects a 50 ohm signal source impedance. However, a 75 ohm source impedance is typically associated with some applications such as cable television, which uses the dBmV as a "standard" amplitude measurement unit. The 2712 provides two ways to make 75 ohm measurements.

On the one hand, when making narrowband measurements (carrier-to-noise ratios, relative amplitudes of signals close together in frequency such as television visual and aural carriers, bandwidths of narrow signals, interference levels relative to a nearby signal, etc.), you can generally connect the 2712 directly to a 75 ohm source. For these cases, item 2 of the Input Menu (50 OHM DBM/75 OHM DBMV) automatically inserts correction factors to account for the 75/50 ohm impedance difference and the conversion from dBm to dBmV. If a 75 ohm source is connected to the input of a 75 ohm instrument, the voltage will be 1.9 dB higher than it is with the same source connected to the 50 ohm input of the 2712. We can also calculate that 0 dBm dissipated in 50 ohms is equal to 47 dBmV across the same resistance. The total difference is, therefore, 48.9 dB. Item 2 of the Input Menu differs from the dBmV unit chosen via [INPUT]/[3]/[1] by including the 1.9 dB factor to account for the higher voltage which would be present at the input to a 75 ohm instrument.

Ensure the reference level is set to 0.0 dBm. Toggle the input impedance/reference units between 50 OHM DBM and 75 OHM DBMV by pressing:

[INPUT]/[2]

Once again the spectral display is unchanged, but the reference level has been converted to 48.9 dBmV to reflect the new source impedance and units.

Return to 50 OHM DBM by pressing [INPUT]/[2] again.

If you do not reselect the 50 ohm mode, a 1.9 dB impedance correction remains regardless of the units you select.

NOTE

Selecting item 2 from the Input Menu does not change the 2712 input impedance; it only inserts a correction for the 50/75 ohm impedance mismatch and a conversion factor from dBm to dBmV.

On the other hand, when making broadband measurements or measurements of absolute amplitude (antenna, system, or

amplifier sweeps; absolute carrier amplitude; comparison of signals widely separated in frequency; etc.), you may want to present a matched load to the source to provide maximum flatness and to minimize standing wave ratios. You can do so by inserting the matching minimum loss pad (a standard 2712 accessory) shown in Figure 6-4 between the source and the analyzer. To obtain correct dBmV readings, set the Input Menu measurement parameters as follows :

Item 2:	50 OHM DBM/75 OHM DBMV	50
Item 3:	REF LEVEL UNIT	DBMV
Item 6:	EXTERNAL ATTEN/AMPL	-7.5

In this case, you select the dBmV unit via [INPUT]/[3]/[1] and the 50 ohm source because the analyzer is matched to the 50 ohm side of the minimum loss pad and the signal really is being terminated in a 75 ohm impedance. Further, it is the attenuation of the pad which is entered under item 6 and not its insertion loss. The 7.5 dB accounts for both the insertion loss and the fact that the signal at the input to the minimum loss pad is 1.9 dB greater than it would be if the 75 ohm source were connected directly to the analyzer.

If in doubt whether the pad is needed, compare a measurement with the pad to the same measurement without the pad. If there is no significant difference, abandon the pad. In some cases, such as carrier-to-noise measurements, the use of a pad may drop your system noise level below the analyzer noise floor. In such cases, the pad cannot be used. Removing the pad typically does not distort C/N measurements.

When a 75 ohm source is routinely used, you can make the settings above part of the spectrum analyzer user-defined power-up (see the **UTIL** discussion later in this section); then you won't have to change the settings each time the 2712 is used.

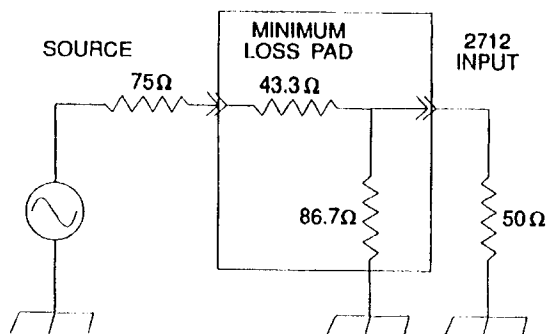

Figure 6-4. 75/50 ohm matching minimum loss pad.

Setting the First Mixer Input Level

Overdriving the analyzer's first mixer circuit can generate spurious signals and cause inaccurate measurements. As the signal amplitude increases past the maximum linear range of the circuit, its output amplitude becomes less than it should be. This creates lower-than-actual amplitude measurements and generates spurious signals through the processes of intermodulation or harmonic distortion. On the other hand, if the signal amplitude at the mixer is too low, signals may become lost in the analyzer's internal noise. An optimum compromise is achieved within the 2712 by making the top graticule line represent a $-30\ \text{dBm}$ level at the input to the first mixer.

However, in cases where total signal energy is large, it may be beneficial to restrict the input to the mixer to a smaller value. By resetting the first mixer input level to, say, $-40\ \text{dBm}$, you increase the RF attenuation by $10\ \text{dB}$ while simultaneously increasing the IF gain $10\ \text{dB}$. This provides additional protection to the first mixer. In other cases, you may want to examine a low-level signal adjacent to a high-level signal. A $-20\ \text{dBm}$ level at the first mixer allows you to get an additional $10\ \text{dB}$ of sensitivity by reducing the RF attenuation $10\ \text{dB}$ but decreasing the IF gain $10\ \text{dB}$ to compensate. The danger is that internally generated distortion products may become more noticeable.

To change the signal level at the mixer, press:

[INPUT]/[4]

You are prompted to enter a new mixer input level. You can enter values from -50 dBm to -20 dBm in 2 dB steps. Try **-20 dBm** and **-40 dBm** while observing the level of the noise. Because the RF attenuation is increased by the same amount the first mixer input is decreased, the noise floor rises as the mixer level is reduced. When you are done experimenting, set the mixer input level back to -30 dBm.

100.0MHz	(AUTO SWEEP)	ATTN 0DB
-50.0DBM		VF 300KHz
5MHz/		10 DB/
300KHz RBW (AUTO)		

Turning the Preamplifier On and Off

Your spectrum analyzer is equipped with an internal preamplifier. The preamplifier can be very useful when measuring cable TV noise (see the C/N discussion later in this chapter) or other signals near or below the normal analyzer noise floor. It is also useful for increasing the sensitivity of radiated RF energy measurements (leakage, RFI/EMI, etc.). The nominal gain in sensitivity using the preamplifier is 12 dB. Above 600 MHz the preamplifier remains useable and useful, but its flatness rolls off somewhat and is not specified. To be effective, the preamplifier must be used with no RF attenuation. The preamplifier is not normally turned on because it can easily result in overdriving the first mixer. The signal amplitude at the first mixer with the preamplifier on and no RF attenuation is equal to the input signal level plus about 18 dB. In other words, a -40 dBm signal would overdrive the first mixer. Total signal amplitude greater than -48 dBm at the input to the analyzer with the preamplifier turned on may create spurious signal components and produce unreliable amplitude measurements.

Note the level of the noise floor and then press:

[INPUT]/[1]

Item 1 of the Input Menu toggles the preamplifier on and off. The preamplifier is now turned on as indicated by the term:

PRE

following the reference level readout.

Again note the noise floor; it should be about 12 dB lower than before. The analyzer has automatically reduced its internal gain (thus lowering the normal noise floor) to compensate for the added gain of the preamplifier. The result is that you can now see signals which are up to 12 dB below the normal analyzer noise floor. **Toggle the preamplifier off.**

Using the DBUV/M

The decibel relative to a microvolt per meter ($\text{dB}\mu\text{V}/\text{m}$) is an electric field strength unit that characterizes the intensity of radiated RF energy. Typically, the radiated signal amplitude is measured at the terminals of a calibrated antenna to determine the field strength. With most spectrum analyzers, you then correct the measured signal amplitude for any external gain or attenuation, convert signal amplitude to radiated intensity using the antenna factor (often referred to as the K-factor) for your antenna, and scale the field strength for the difference between the measurement distance and the required reference distance. There is ample opportunity for arithmetical errors. The 2712, however, performs the correction, conversion, and scaling for you. Input the external gain or attenuation, antenna factor, and measurement distance using the Input Menu. Then select the $\text{dB}\mu\text{V}/\text{m}$ reference unit and the 2712 does the rest. The signal intensity is read out on screen using the marker, corrected for distance, in either $\text{dB}\mu\text{V}/\text{m}$ or volts/meter. Using the Display Menu, it is also possible to have the 2712 sound a high level audible alert if the measured signal exceeds a threshold that you set. This feature facilitates go/no-go or present/absent tests.

Figure 6-5 shows how to set up your equipment. A balun may be included as part of your antenna. The filter and external matching network are optional. The filter is intended primarily to prevent off-the-air signals, such as radio and television, from swamping the analyzer. The matching network may be necessary for maximum accuracy. If in doubt, try the measurement with and without the network. If there is no difference, omit the network for maximum sensitivity.

The following formula relates the radiated field strength in dB relative to a microvolt per meter (dB μ V/m) to the measured signal amplitude in dB relative to a milliwatt (dBm), and scales the result measured at a distance d_{meas} to a reference distance, d_{ref} . The reference distance is often specified by the regulatory agencies.

$$P_{\text{dB}\mu\text{V/m}} = P_{\text{dBm}} + 107 + 20 \log \left(\frac{d_{\text{meas}}}{d_{\text{ref}}} \right) - A + K$$

d_{meas} = distance from radiation source at which measurement is carried out

d_{ref} = reference distance at which the intensity is desired

A = attenuation or gain between antenna and analyzer. If the filter is used, its gain or attenuation should be included in this number. If balun losses are not included in the antenna factor, they should be included here. Cable loss, if significant, can also be included here.

K = antenna factor; supplied by manufacturer or calculated from:

$$K = 20 \log f - G - 10 \log (19 \cdot R_{\text{ant}})$$

G = antenna gain as a function of frequency

f = frequency of signal in MHz

R_{ant} = output resistance of the antenna or the balun, if the balun is treated as part of the antenna

COMMERCIAL BICONICAL ANTENNA WITH BALUN ATTACHED

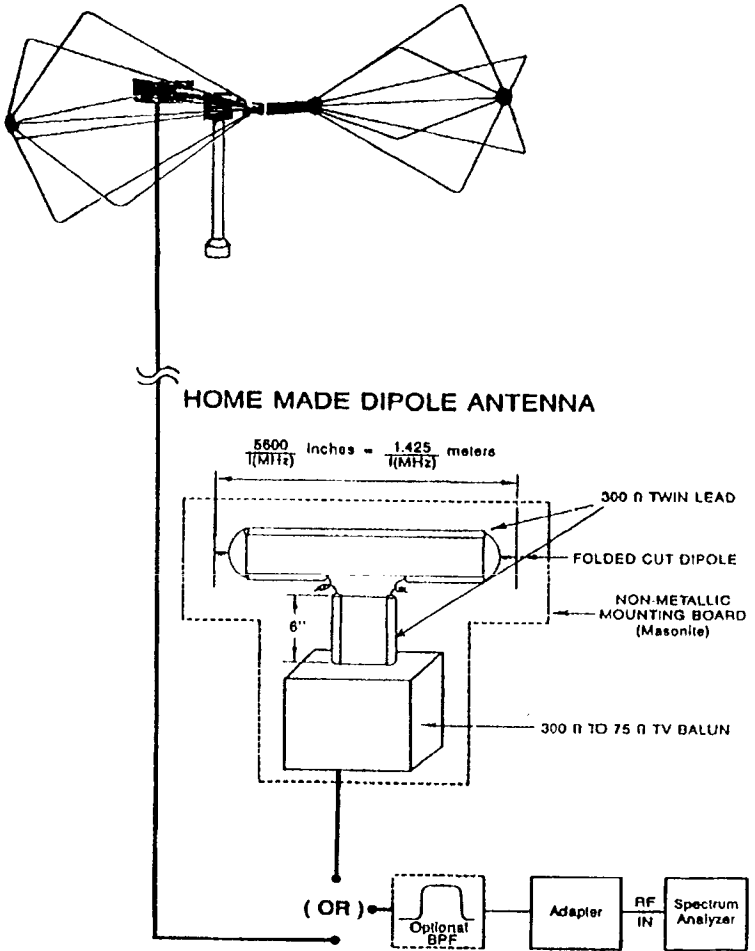

Figure 6-5. Equipment setup for field strength measurements.

With the 2712, you enter the attenuation using the **EXTERNAL ATTEN/AMPL** feature from the Input Menu, and the antenna factor, measurement distance, and reference distance using the **DBUV/M SETUP** under the **REFERENCE LEVEL UNITS** of the Input Menu. Note that many commercial antenna suppliers include the balun losses in the antenna factor. For the most accurate results, use an antenna calibrated at the specified reference distance and perform the measurement at that distance. If possible, measure the return loss of the antenna to make certain it is properly tuned to the desired frequency. See *Spectrum Analyzer Fundamentals*, Tektronix application note 26W-7037-1, concerning return loss measurements.

To use the $\text{dB}\mu\text{V/m}$, follow this procedure:

- Select item 3, **REF LEVEL UNIT**, from the Input Menu.
- Select item 9, **DBUV/M SETUP**, from the **REFERENCE LEVEL UNITS** submenu.
- Select item 6, **MEASUREMENT DISTANCE**, from the **DBUV/M SETUP** and enter the distance at which the measurement will actually be carried out (default distance is 3.0 m). You can enter distances in feet, meters, kilometers, or miles, but the 2712 converts them to meters or kilometers before displaying them.
- Repeatedly select item 7, **SAVE RESULTS IN WFMx**, until the indicated register (**A**, **B**, **C**) is the one in which you want the resulting measurement to appear. The waveforms are repeatedly saved, deleted, saved, and so on until you terminate the $\text{dB}\mu\text{V/m}$ mode. At that point, the last sweep is retained in the selected register.
- Item 9, **MARKER DISPLAY**, controls whether the on-screen marker amplitude reads out in decibels relative to a microvolt per meter (**DBUV/M**) or directly in volts per meter (**V/m**). The reference unit does not change; only the marker amplitude readout changes. **Toggle item 9 to select the units you prefer.** Table 6-1 also lists equivalent voltage and decibel values in 4 dB steps. Interpolate between values if closer results are required.

Table 6-1. Equivalent decibel - voltage values.

dB μ V/m	0	4	8	12	16	
0	1	1.58	2.51	3.98	6.31	microvolt per meter
20	10	15.8	25.1	39.8	63.1	
40	100	158	251	398	631	
60	1	1.58	2.51	3.98	6.31	millivolt per meter
80	10	15.8	25.1	39.8	63.1	
100	0.1	0.158	0.251	0.398	0.631	volt per meter
120	1	1.58	2.51	3.98	6.31	

- Select the antenna number (1-5) which matches the antenna you are using.
- Press the back arrow key to return to **REFERENCE LEVEL UNITS** and select item 5, **DBUV/M IN WFM x**.
- Press **[INPUT]/[6]** and enter any external gain or attenuation (skip this step if none is present). This number should include the gain or attenuation of any external amplifier or filter, and the losses of any balun which are not included in the manufacturers K factor table for your antenna.
- Connect your antenna and proceed with your measurement. To obtain a measure of the maximum signal strength, save the measurement in the **A** or **B** register and select **MAX HOLD**. Rotate the antenna until the maximum reading is obtained.
- Turn on the marker and use it to read out the field strength directly in dB μ V/m or V/M.

While you are using the dB μ V/m unit, you cannot unsave the destination register or use the **LIN**, **FM DEMODULATOR**, or **EXTERNAL SOURCE** features (you also cannot select the dB μ V/m unit while using these features). Attempting to do so will result in an error message.

If you turn off the destination register while using the dB μ V/m, this message is displayed:

DBUV/M MEASUREMENT MODE IDLE

The dB μ V/m measurement is not made while idling, and you still cannot unsave the destination register or use the LIN, FM DEMODULATOR, or EXTERNAL SOURCE features.

To disable the dB μ V/m measurement mode, select any other reference unit.

If you are using an antenna for the first time, you need to create an antenna table. From time to time you may also need to alter an existing table. Whether creating new antenna tables or changing old tables, all editing takes place in the "local buffer" or "editing buffer" using the EDIT ANTENNA TABLE selection from the DBUV/M SETUP on the Input Menu. New antenna data are written directly to the buffer prior to permanent storage; old data are loaded into the buffer prior to editing and re-storage. **If you wish to enter new antenna data or change old data, use this procedure:**

- **Select DBUV/M SETUP as above and then select item 0, EDIT ANTENNA TABLE.**
- **To create a new antenna entry, select item 6, ANTENNA SETUP. Enter the start, stop, and frequency steps at which measurements will be made. Enter the reference distance.** The reference distance is the distance to which you want the field strength referred. For maximum accuracy your antenna should be calibrated at the reference distance, and your measurement made at that distance. However, if you require another distance, enter it here. For instance, if you are making measurements at 10 meters, but want the field strength at 3 meters, then enter 3 meters. **Press the back arrow key to return to EDIT ANTENNA TABLE.** Item 0 will continue to indicate EMPTY at the end of the line because there are still no antenna factors in the local buffer.
- **To edit an old antenna, select item 3, LOAD, from the EDIT ANTENNA TABLE and choose the antenna you want to edit.** If there is already something in the local buffer, you are given the choice:

W = OVERWRITE LOCAL BUFFER
Z = ABORT

If you need the data currently in the local buffer, abort the procedure and store it. Otherwise, select the **W** option. After the antenna is loaded, its name (if it has one) or number is shown at the end of the first line of **EDIT ANTENNA TABLE** indicating that the antenna factors for that antenna have been loaded into the local buffer.

- If you attempt to change the frequencies at which you plan to use an antenna, whether it is a newly created antenna or an old, you must delete the local buffer and start over as though it is a new antenna. To delete the local buffer, select item **4, DELETE**, from **EDIT ANTENNA TABLE** and then select item **6, EDITING BUFFER**. Confirm the deletion by pressing **[Y]** and proceed as though you are creating a new antenna table.
- After you have loaded an old antenna table or established the frequency range and calibration distance for a new one, select item **0** from **EDIT ANTENNA TABLE**. A list of frequencies beginning with the start frequency and ending with the stop frequency appears. The numbers to the right of the frequencies are the antenna factors, or K-factors. When creating antenna tables, the 2712 supplies default values of zero for the K-factors. To begin changing the antenna factors, press **[W]** and enter the appropriate factor. The asterisk indicates which factor is to be edited. After you enter a value for a factor, the asterisk moves to the next frequency. If you do not want to change the antenna factor at the indicated frequency, turn the **FREQ/MKRS** knob to move the asterisk to the desired frequency.

For instance, suppose an antenna manufacturer specifies the antenna factors for his antenna as:

f	K	f	K	f	K
.....	55.0	2.7	60.0	3.5
51.0	2.1	56.0	2.9	61.0	3.6
52.0	2.3	57.0	3.0	62.0	3.8
53.0	2.4	58.0	3.2	63.0	3.9
54.0	2.5	59.0	3.3

Then to make measurements from 55 to 60 MHz, the entries in the antenna table should look like this:

1>	55.000000 :	2.7
2>	56.000000 :	2.9
3>	57.000000 :	3.0
4>	58.000000 :	3.2
5>	59.000000 :	3.3
6>	60.000000 :	3.5

- If you are creating a new antenna table, press [Z] to exit (return to **EDIT ANTENNA TABLE**) after the last entry has been completed. If you are editing an existing table, press [W] after your last entry. Then press [Z] to return to **EDIT ANTENNA TABLE**.
- Naming antennas is not required, but names can provide quick reminders of the purpose of each antenna. To name an antenna, select item 1, **TITLE EDIT**. Press [W] to begin editing. If an old antenna table is being modified, its name appears at the upper left with an underscore cursor beneath the first letter. If the antenna table is new, only the cursor appears. You can delete the old name entirely by pressing [Y]. [Z] aborts the title editing process without changes. To change the title, turn the **FREQ/MKRS** knob to select letters. Use [MKR →] or [MKR ←] to move the cursor back and forth. When the title is complete, press [X].
- To store the antenna data and title, select item 2, **STORE**, and choose any unused antenna number. The new or modified antenna table will be stored under that number. Its name is displayed adjacent to the number. If you do not name the antenna, it is given a name of **ANTENNA #**. If all five antenna tables are already in use, you will have to delete an existing antenna before you can store the new or modified table. For instance suppose you have modified an existing antenna table and wish to store the modified version in the place of the original table using the same antenna name. Even though the name and location are the same, you must first delete the original antenna table. Deleting the original antenna

from the antenna list does not delete the edited version in the local buffer. After you delete the original, store the edited version in the original location.

- You can print the antenna data if your 2712 is equipped with an optional communications port and appropriate printer. To print the antenna data, select item **5, PRINT**, from **EDIT ANTENNA TABLE** and simply choose the antenna data you want to print from the resulting list.
- The **DISPLAY LINE** feature (**[DSPL]/[8]**) can be used with the $\text{dB}\mu\text{V}/\text{m}$ for making vehicular surveys of leakage from cable TV installations, or in other applications where an audible alert is useful whenever a signal amplitude crosses a preset threshold. To sound a high level alert whenever the measured RF field strength exceeds the threshold, set the **DISPLAY LINE** at the desired threshold. See *The Display Line and Limit Detector* in this section for complete details.

To look for very low amplitude RF energy, you can turn on the 2712's preamplifier. Actual sensitivity depends on the antenna used and losses in cabling and coupling to the analyzer. With minimum cable losses and an antenna that matches the 50 ohm analyzer impedance, you should be able to see signals ranging from about $2 \text{ dB}\mu\text{V}/\text{m}$ ($1.3 \mu\text{V}/\text{m}$) at 55 MHz to $14 \text{ dB}\mu\text{V}/\text{m}$ ($5 \mu\text{V}/\text{m}$) at 216 MHz.

If greater sensitivity is required, three options are possible:

- a. Provide an external preamplifier.
- b. Use a higher gain antenna. Sensitivity increases directly as antenna gain.
- c. If the signal being measured is narrowband, reduce the RBW to the narrowest setting still capable of passing the signal. For instance, the 3 kHz filter increases sensitivity by a further 20 dB over the 300 kHz filter.

100.0MHz	(AUTO SWEEP)	ATTN 10DB
-20.0DBM		VF WIDE
20.0MHz/		10 DB/
5MHz RBW (AUTO)	CALIBRATOR	

MKR/FREQ

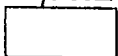

With the Marker/Frequency Menu you can directly affect the frequency characteristics of the spectral display and control the markers in

ways not available from the front panel.

Setting the Start and Stop Frequencies

Perhaps you would prefer to directly specify the beginning and ending frequencies of the display rather than its center frequency and span. The 2712 enables you to do so.

To set the display start and stop frequencies, press:

[MKR/FREQ]/[7]

From the resulting menu, select item **7, FREQUENCY START/STOP**. A submenu appears enabling you to specify start and stop frequencies for the spectral display. Choose item **0** and, following the prompt, press:

[1]/[7]/[5]/[MHz]

to specify a start frequency of 175 MHz. Note that the indicated start frequency has changed. Now choose item **1** and enter a value of 425 MHz for the stop frequency.

Return to the spectral display by pressing **[MKR/FREQ]**.

The span is 25 MHz/division making the start and stop frequencies 175 MHz and 425 MHz respectively. If you make the start frequency greater than the stop frequency, the analyzer enters ZERO SPAN mode tuned to the start frequency.

Using Markers To Set Start and Stop Frequencies

You can also set the start and stop frequencies with the markers. This method provides a visually intuitive approach to span control, enabling you to designate only that portion of the displayed spectrum which is of particular interest.

Turn on the marker and place it just to the left of the calibration signal harmonic at 300 MHz. Enter delta-marker mode and place the active marker just to the right of the harmonic at 400 MHz. Select item **6, MARKER START/STOP**, from the Marker/Frequency Menu.

The spectral display reappears and brackets the calibration signal third and fourth harmonics. The marker start/stop selection automatically adjusts the starting frequency of the display and the span/division so that what is displayed is what was between the markers. If you are not in delta-marker mode when you select **MARKER START/STOP**, the analyzer will enter zero span at the current center or marker frequency.

Now turn off the markers. Notice that the resolution BW has also changed because **RES BW** was in **AUTO** mode.

300.0MHZ	(AUTO SWEEP)	ATTN 10DB
-20.0DBM		VF WIDE
50.0MHZ/		10 DB/
5MHZ RBW (AUTO)	CALIBRATOR	

Transposing Markers

Now suppose you want to measure the difference in frequency between the peaks at 300 MHz and 500 MHz and between 500 MHz and 200 MHz (forget that you can do it in your head!). To do so, enter marker mode, and position the marker on the 300 MHz peak. Enter delta-marker mode and place the active marker on the 500 MHz peak.

Naturally, the difference is 200 MHz. Now comes the neat part. Select item **5, TRANSPOSE MARKERS**, from the Marker/Frequency Menu. Turn the **FREQ/MKRS** knob. The movable marker has become the reference and the old reference is now the movable marker. Move the marker to the 200 MHz peak and note the frequency difference. How much easier that was than having to turn the markers off, and then back on again for the second difference measurement.

Exit from delta-marker mode.

100.0MHZ	(AUTO SWEEP)	ATTN 10DB
-20.0DBM		VF WIDE
20.0MHZ/		10 DB/
5MHZ RBW (AUTO)	CALIBRATOR	

Changing the Knob Function

Here is a feature which enables you to select one of up to four parameters to be controlled by the **FREQ/MKRS** knob. The knob is normally used to vary the center/start frequency or marker position, but if the video monitor and tracking generator options are installed, you can also vary the video line selection and TG tracking.

To see how this feature is used to make precision frequency difference measurements across the whole range of the analyzer, enter delta-marker mode with both markers at the cal signal peak. What you're now going to do is measure the frequency difference between the cal signal and each of its harmonics, but you could use the same procedure to measure any series of signals.

To change the knob function, call up the Marker/Frequency Menu and select item 2, **KNOB FUNCTION**. The Knob Function Menu appears. Currently, the knob is controlling the markers, as you would expect in delta-marker mode. Select item 0 from the Knob Function Menu to change to frequency control and then press **[MKR/FREQ]**. The spectral display reappears and seems unchanged.

However, watch what happens as you rotate the **FREQ/MKRS** knob several clicks clockwise. Notice how the center frequency increases and the spectrum slides to the left. One marker remains fixed atop the cal signal peak while the other remains fixed at center scale. Consequently, the difference frequency also increases. Continue turning the knob until the second harmonic approaches center scale. Press **[CTR MEAS/TRKG]**. The second harmonic is automatically centered. The amplitude and frequency difference between the fundamental and the harmonic are displayed at the

top of the right column preceded by DC (delta count). **Repeat this procedure for the third harmonic.** Did you notice that although the reference peak (the cal signal fundamental) is now far off-screen to the left, you are still accurately measuring the difference frequency?

You can continue this process all the way to 1.8 GHz. **Go ahead, try measuring a few more harmonics. Exit from this mode by turning off the markers.**

This feature is particularly useful when you want to measure the differences between two or more signals so widely separated in frequency that they do not fit on screen at the span/division at which you wish to view them. If you're already using the Marker/Frequency Menu, item 2 also conveniently turns on marker mode when it is set to MKR.

If you trigger the 2712 with a TV video sync pulse by choosing KNOB SELECTABLE from the Sweep/Trigger Menu Setup Table, the Knob Function Menu offers another choice: VIDEO LINE. Selecting VIDEO LINE lets you use the FREQ/MKRS knob to control which TV line triggers the sweep. Selecting FREQUENCY or MARKER continues to let you control the center or marker frequency. This feature enables you to conveniently flip between frequency and TV line control. This can be very useful when viewing multiple TV channels. You can select FREQUENCY for changing channels and then to VIDEO LINE for choosing the line number. For a complete explanation of TV LINE trigger mode, see *TV Line Triggering* later in this section.

If the tracking generator option is installed in your 2712 and turned on, still another choice of knob function is possible: TG TRACKING. The knob now varies the frequency by which the tracking generator output frequency differs from the frequency currently being scanned by the 2712. This makes it possible to peak the response of narrow filters and to compensate for the signal delay encountered when testing long cables (the signal received at the end of the cable is delayed and, hence, differs in frequency from that currently being scanned).

300.0MHZ	(AUTO SWEEP)	ATTN 10DB
-20.0DBM		VF WIDE
50.0MHZ/ 5MHZ RBW (AUTO)	CALIBRATOR	10 DB/

Moving the Marker To the Next Higher or Lower Peak

The front-panel controls enable you to move the marker to the next signal peak to the left or right, but the Marker/Frequency Menu enables you to jump the marker from peak to peak in ascending order of amplitude, and then jump down again in descending order.

Turn on the single marker and place it in the noise - it doesn't matter where. Select item 4 from the Marker/Frequency Menu and then press [W]. The marker is now atop the lowest of the calibration signal harmonics. **Select item 4 and press [W] again.** The marker is now atop the second lowest peak. **Repeat this process until the marker reaches the highest peak (the fundamental).** After the marker is on the highest peak, **select item 4 and press [X].** Repeat this process several times and watch the marker jump to progressively lower peaks. If you try to jump the marker above the highest peak or below the lowest, you are told:

NO SIGNAL FOUND ABOVE THRESHOLD

You cannot jump the marker to off-screen signals.

Marker To the Reference Level

MARKER TO REFERENCE LEVEL is an item on the MKR/FREQ Menu that can be used to quickly and easily determine signal amplitudes.

Using any method, (for instance, the MOVE MARKER TO NEXT PEAK feature), place the marker atop the signal to be measured. In this case, use the calibration signal fundamental. With the marker at the signal peak, press [MRK/FREQ]/[3].

The reference level is changed to the signal amplitude. This is a handy way to place signals at the reference level for making relative measurements. It is also a convenient method of setting the video carrier to the reference level when using the video monitor option.

When you are finished, turn off the marker.

NOTE

Signal amplitudes are always determined most accurately when the signal is within one division of the reference level.

300.0MHz	(AUTO SWEEP)	ATTN 10DB
-20.0DBM		VF WIDE
50.0MHz/		10 DB/
5MHz RBW (AUTO)	CALIBRATOR	

Selecting the Tuning Increment

Earlier, you learned the tuning increment (amount per click by which the tuning knob changes frequency) is 0.02 of the span/division. You are now going to learn how this can be changed. **Call up the Marker/Frequency Menu and look at item 8.** It is a three-way toggle function indicating the tuning increment is presently being automatically selected by the 2712. In **AUTO** mode, the tuning increment is:

Zero span:

- .033 of the resolution BW for 300 Hz, 3 kHz, and 30 kHz filters
- .05 of the resolution BW for 1 kHz, 10 kHz, 100 kHz, and 1 MHz filters
- 20 kHz for the 300 kHz or 500 kHz filter
- 200 kHz for the 5 MHz filter

All other spans:

- 0.02 of the span/division (because of the readout resolution, this appears as 3 and 4 MHz on alternate clicks of the knob in **MAX SPAN**)

Slowly press **[8]** three times.

The tuning increment progresses from **AUTO** to **PROGRMD** (programmed) to **TABULAR** and back to **AUTO** again. If programmed tuning is selected (see *Programmed Tuning* later in this section), you can specify whether the center frequency, marker frequency, or keypad entered frequency increment will be used as the tuning increment. If tabular tuning is selected (see *Tabular Tuning* later in this section), the tuning increment varies according to tables of values stored in ROM. Tables exist for standard broadcast and cable TV channel allocations.

Center or Start Frequency

Let's look at the setup table. Choose item **9** from the **Marker/Frequency Menu**.

A secondary menu of seven items appears. The first item toggles frequency control between center and start frequency. When start frequency is selected, the **FREQ/MKRS** knob controls the frequency at the left edge of the display rather than the frequency at the center. Choose item **0** from the setup table. The spectral display reappears but the "center frequency" bright spot is now moved to the left edge of the screen and the frequency readout is:

SF 300MHz

indicating that the start frequency is now 300 MHz. Some users prefer to run the analyzer in this mode. This feature can be useful for viewing sidebands or performing harmonic distortion measurements.

Toggle back to center frequency control by pressing **[MKR/FREQ]/[9]/[0]**.

Setting the Signal Threshold

Earlier you discovered there was a threshold below which the 2712 would not automatically detect signal peaks. Normally the analyzer estimates the peak amplitude of the minimum

displayed signal (which usually represents the noise floor) and sets the threshold one division higher. However, when the displayed signal is everywhere greater than the noise, the analyzer sets the threshold in proportion to the signal peaks rather than the noise floor. The threshold is then artificially high, and may result in other signals which rise only slightly above the threshold being ignored. Consequently, item 0 of the MKR/FREQ Menu has been provided to enable you to set the threshold to a fixed amplitude suitable for detecting the signals present in your particular application. The fixed threshold is also handy when you simply want to exclude low-level signals while jumping the marker amongst high level peaks.

To set the threshold, choose **Item 0** from the **MKR/FREQ** menu and, following the prompts, enter a value of **-45 dBm**. Press **[MKR/FREQ]** to return to the spectral display. Using either the **MOVE MARKER** selection from the **MKR/FREQ** Menu or the marker arrow keys, attempt to move the marker from peak to peak. It will only jump to the peaks above -45 dBm in amplitude.

Turn off the marker and restore automatic threshold selection by pressing;

[MKR/FREQ]/[0]/[-dBx]

Then return to the spectral display.

Counter Resolution

The 2712 enables you to change the resolution of its built-in counter. It is possible to specify its resolution as 1 kHz or 1 Hz, or to turn off the counter when Signal Track mode is in use. Be aware that this feature only changes the counter resolution to one Hertz, not the accuracy (see **CTR MEAS/TRKG** in section 5 for a discussion of frequency measurement accuracies).

Press **[MKR/FREQ]/[9]/[1]**. Under **COUNTER RESOLUTION**, select item **0**, **COUNTER OFF WHEN TRKG**. Press **[CTR MEAS/TRKG]** and notice the counter reads out to 1 Hz. Enter **TRKG** mode and note that there is no counter reading.

Return to **COUNTER RESOLUTION** and select **1 KHz**. Notice the counter is now reading in **TRKG** mode. When you select items 1 or 2, the counter reads out to the indicated resolution in either **CTR MEAS** or **TRKG**. Because it takes longer to update the display when the counter is reading out, turning it off speeds up the signal tracking capability.

Reselect item **0** from **COUNTER RESOLUTION**, and then turn off **TRKG** mode.

300.0MHz	(AUTO SWEEP)	ATTN 10DB
-20.0DBM		VF WIDE
50.0MHz/		10 DB/
5MHz RBW (AUTO)	CALIBRATOR	

Programmed Tuning

Let's look at programmed tuning increments. Choose item **1** from the **MKR/FREQ** Menu. The Programmed Tuning Increment Menu appears. Programmed tuning increments can be designated by the center or start frequency, the marker or delta-marker frequency, or numeric keypad entries.

The current center frequency is approximately 300 MHz (as would be the start frequency if you placed the analyzer in that mode.) Let's select the center frequency as the tuning increment.

Press **[0]**. The spectral display reappears. Turn the **FREQ/MKRS** knob one click clockwise. The frequency changed 300 MHz in one click! Well, that's what you selected as the tuning increment. Turn the knob another click. 900 MHz, right? Now reset the center frequency to 300 MHz.

Turn on the marker. Position the marker at 150 MHz. Again select item **1** from the **MKR/FREQ** Menu. Now choose item **1**, which currently reads **MARKER FREQ**, from the Programmed Tuning Increment Menu to select the marker frequency as the tuning increment. Turn off the marker and turn the **FREQ/MKRS** knob one click. The frequency should change 150 MHz.

Reset the frequency to approximately 300 MHz. Turn on the marker and position it on the calibration signal fundamental at 100 MHz. Enter delta-marker mode and place the movable marker on the second harmonic at 200 MHz. From the Programmed Tuning Increment Menu reselect item 1 which now reads DELTA MKR FREQ. Turn off the markers and turn the FREQ/MKRS knob one click.

The frequency now changes by one harmonic (100 MHz) per click. When making distortion measurements, this is one way to look at positions where harmonics should be present. In fact, anytime your measurements require you to look at multiples of a frequency difference, but you don't want to be bothered with actually entering the frequency, the delta-marker tuning increment mode provides a quick, convenient way of doing it.

Return to the Programmed Tuning Increment Menu. You are going to specify a particular tuning increment. **Choose item 3, KEYPAD ENTRY, and enter a value of 7 MHz.** The spectral display reappears. **Turn the FREQ/MKRS knob.** The frequency changes by 7 MHz per click, a value not otherwise available. Entering a keypad tuning increment automatically places the 2712 in programmed tuning mode.

You can turn off any programmed increment, including the keypad entered increment, in two ways. **First, toggle item 8 on the Marker/Frequency Menu to read AUTO.** This turns off the keypad value and restores automatic selection of the tuning increment. **Second, select the programmed tuning increment from the MKR/FREQ Menu and choose item 4 (RETURN TO AUTO) from the Programmed Tuning Increment Menu.** This also turns off the keypad value and restores automatic selection of the tuning increment.

Turn the keypad increment back on by reselecting PROGRMD TUNING INC from the MKR/FREQ Menu, and choosing item 2, KEYPAD ENTRD INC.

Now turn off the keypad selected increment.

100.0MHz	(AUTO SWEEP)	ATTN 10DB
-20.0DBM		VF WIDE
20.0MHz/		10 DB/
5MHz RBW (AUTO)	CALIBRATOR	

Tabular Tuning

Call up the **MKR/FREQ** Menu Setup Table and select item 2, **TABULAR TUNING TABLES**. A table appears offering you a number of choices. Choose item 0 from the **TABULAR TUNING TABLE**, and then press the backspace key twice to return to the **MKR/FREQ** Menu. Toggle item 8 until:

TABULAR

appears at the end of the line. Press **[MKR/FREQ]** to return to the spectral display. Turn the **FREQ/MKRS** knob one click counter-clockwise. The frequency is 87.7 MHz. Turn the knob three more clicks. The indicated frequencies are 83.2 MHz, 81.7 MHz, and 77.2 MHz. Do you recognize the sequence? The analyzer is stepping through the visual and aural carrier frequencies of US broadcast TV stations. It will step through the entire range of VHF and UHF stations. Had you chosen one of the other items from the **TABULAR TUNING TABLE**, the analyzer would have stepped through the various TV assignments peculiar to those settings. Tabular tuning can be a great convenience if you work in the video communications industry.

Restore tuning increment selection to automatic.

300.0MHz	(AUTO SWEEP)	ATTN 10DB
-20.0DBM		VF WIDE
20.0MHz/ 5MHz RBW (AUTO)	CALIBRATOR	10 DB/

Frequency Offsets

The Marker/Frequency Setup Table also enables you to offset the on-screen center frequency readout. The center frequency is not actually changed, and the counter readout still indicates the true frequency rather than the offset value. This feature is intended to allow the output frequencies of block down converters (LNB's) used in video communications and other industries to be correctly indicated. However, it can be used anytime a signal has been shifted in frequency by a known amount, and you want to display its frequency prior to shifting.

Suppose the signal to be viewed is the output of a down converter with a 5.15 GHz local oscillator. **Call up the MKR/FREQ SETUP TABLE** and select item 3, **FRQ OFFSET**. Enter an offset of 5.15 GHz (ignore the **CALIBRATOR DOESN'T MATCH READOUT** warning). Notice that the status of item 4, **FREQ OFFSET MODE**, changed from **OFF** to **ON PLUS**. Select item 4 several times. The status of the frequency offset cycles through **OFF - ON PLUS - ON MINUS**. Leave the offset set to **ON PLUS** and return to the spectral display. The center frequency is now indicated as 5450.0 MHz (300 MHz + 5150 MHz offset).

Press **[CTR MEAS/TRKG]**. The counter readout still indicates the true center frequency. **Turn on the marker and turn the MKR/FREQ knob clockwise**. The marker frequency is also increased by 5.15 GHz.

Return to the MKR/FREQ Setup Table and toggle item 4 to ON MINUS. Return to the spectral display. The center frequency now reads 4850.0 MHz and the marker reads progressively lower frequencies as it moves to the right.

Why does the frequency axis appear reversed? Because the output frequency of the converter can be represented as:

$$f_{\text{out}} = |f_{\text{sig}} \pm f_{\text{lo}}|$$

any time the local oscillator in the frequency converter is above the frequency of the original signal, the output frequencies are reversed. That is, the higher the input signal frequency, the lower the output frequency. This is exactly the process that occurs in C-band block down converters. Therefore, you use **ON MINUS** when viewing their output. Ku-band converters, on the other hand, have local oscillator frequencies below the input signal frequency, and you use **ON PLUS** when viewing their output signals.

300.0MHz	(AUTO SWEEP)	ATTN 10DB
-40.0DBM		VF WIDE
20.0MHz/		10 DB/
5MHz RBW (AUTO)	CALIBRATOR	

DSPL



The Display Menu enables you to change the appearance of the display screen and the signals presented on it. From the Display Menu, you can:

- Switch between analog and digital display modes
- Ensemble average spectra
- Directly subtract a stored trace from an active trace
- Switch between **MAX/MIN** and **PEAK** signal acquisition modes
- Title and label displays and plots
- Turn the graticule lights on and off
- Change the source of the display from an internal to an external signal
- Control an on-screen reference line to simplify amplitude measurements and establish alarm thresholds.
- Enable and disable the Min Hold feature

Changing the Display Mode

You can place the 2712 in analog display mode by turning off all the display registers using the A, B, C, and D keys (see *Display Storage* in section 5). However, a more convenient method when two or more registers are active, is to use item 0 on the Display Menu. Item 0 is a toggle that switches the 2712 between analog and digital display modes.

If the 2712 is in digital display mode, pressing item 0 turns off all display registers (enters analog display mode).

When in analog mode, pressing item 0 performs one of two actions:

- If analog mode was entered using item 0, then the register configuration prior to entering analog mode is restored
- If analog mode was entered by manually turning off all registers with the A, B, C, and D keys, then the last register turned off is reactivated.

Ensure the C and D display registers are active. Save the C register and then change the center frequency to 280 MHz so you can distinguish the two active traces.

Press [DSPL]/[0]. Notice that only the analog signal remains.

Press [DSPL]/[0] again. Both the saved C digital display and the current D digital display return (the same register configuration that was in use prior to entering analog mode by selecting item 0).

Turn on the B register, and then turn off all registers in the order D, C, B. Now press [DSPL]/[0]. Notice that the B register, the last one turned off, is the only one reactivated.

Reset the center frequency to 300 MHz and turn on only the D register.

Ensemble Averaging

In general, ensemble averaging techniques are used for the same reason as filters; to enhance the desired-signal-to-unwanted-noise ratio. Narrow resolution BW or video filters reduce the noise by reducing the spectrum analyzer's bandwidth. Unfortunately, they also require slower sweep speeds, and in the cases of broadband signals, the filters may limit the signal energy. For these applications, we can use ensemble averaging. However, if ensemble averaging is used with pulsed waveforms without taking special care to synchronize the analyzer to the signal, erroneous measurements result. This is because of the way scanning analyzers determine the spectrum of pulsed signals. See Tektronix application note 26W-7037-1, *Spectrum Analyzer Fundamentals*, for more information about pulse measurements.

Ensemble averaging computes the average value of some parameter (peak, mean, minimum, etc.) of a number of signal spectra. If the nature of the signal doesn't change during the period over which the average is compiled, the parameter being averaged rapidly approaches its mean value. This results in an enhancement of the signal-to-noise ratio without reducing the bandwidth or slowing the sweep speed. All this doesn't mean you can't ensemble average continuous narrowband signals -- you can. But in those cases you can also use video filtering, which may prove faster and more convenient.

The result of the ensemble average is an estimate of the mean value of the parameter being averaged. The estimate is also a random variable. That is, successive estimates, or averages, will vary from each other in a random fashion. However, the random variability is less than that encountered with a single sweep, and therein lies the advantage of ensemble averaging. The larger the number of sweeps averaged, the more accurate an estimate of the spectral characteristic that is obtained.

Call up the Display Menu by pressing [DSPL]. Select item 1, ENSEMBLE AVERAGING.

The Ensemble Averaging Menu appears. Items 1 and 2 start and stop the averaging process. The remaining items specify which values to average, how many sweeps to average, and where to store the result.

Let's start at the bottom. If you are going to store just the one ensemble average, it makes little difference where you put it. You can use registers A, B, or C, but you cannot store the average in a register which already contains data. Register D is not available because it always contains the current trace. If you plan to use the stored average as a reference and perhaps intend to subtract it from other spectra, you must store it in register A. Whichever register is used, it must be cleared before you attempt to store new data in it or you'll receive an error message.

Item 8 of the Display Menu is a three-way toggle that switches amongst registers in the sequence A, B, C, A.... **Ensure that register A is clear and then repeatedly press [8] until the last character on the line is A.**

You can average a fixed number of spectra or choose continuous averaging. Continuous, or running, averages are used when the mean value of the signal you are viewing can change slowly with time, or when you want to watch a mean value estimate change in real time -- or when you simply wish to continuously monitor a process.

If you select a fixed ensemble size, you can average up to 1024 sweeps. The 2712 then computes:

$$\text{PARAMETER AVG (f)} = \frac{1}{N} \sum_{i=1}^N \text{PARAMETER}_{\text{sweep } i}(\text{f})$$

where N is the number of sweeps to be averaged, f is frequency, and the parameter being averaged can be the maximum, minimum, max/min, or mean of the spectral display. Averaging begins when item 1 is selected from the Ensemble Averaging Menu and ends when the Nth sweep has been completed. You can also stop the averaging by selecting item 2 from the menu.

Continuous averaging works differently. Until ten sweeps have been accumulated, the continuous average looks exactly like the fixed ensemble average; but after the N^{th} sweep the continuous average approaches:

$$\text{PARAMETER AVG}_N(f) = 0.1 \sum_{i=1}^N (.9)^{N-i} \text{PARAMETER}_{\text{sweep } i}(f)$$

That is, continuous averaging weights older sweeps so that they have a progressively smaller effect on the average. Each step back in time reduces the impact of a sweep to 90 per cent of its previous value.

The factory default setting is a 16-sweep fixed average. **Let's change the number to 24. Choose item 7 from the Ensemble Averaging Menu. Enter 24 by pressing [2]/[4]/[W].** Item 7 will update as you press [W].

You are now ready to compile a parameter average. There are four choices. You have used the max/min display almost exclusively thus far, so let's begin with it. **Choose item 6, MAX/MIN, from the Ensemble Averaging Menu; you'll see the asterisk move down. To start averaging, press [1].**

The spectral display reappears and both status indicators for register A light. At the bottom of the right-hand readout column the number of sweeps averaged is displayed. When all 24 sweeps have been included in the average, the readout stops indicating the number unless the A register is the only one turned on. **Turn the D register on and off several times. See the difference? Most of the sweep-to-sweep variations in the noise have disappeared.**

Let's repeat the experiment, this time storing the MAX average in register B. In this case, only the 256 maximum values of each max/min sweep are averaged and stored.

Press [DSPL]/[1]/[3] to select MAX. Toggle item 8 to register B and select item 1 to start the averaging process. Both status indicators for register B light. Not too surprisingly,

the average peak value almost coincides with the upper edge of the MAX/MIN average. Turn off the A register to see the average maximum by itself.

Turn the A register back on. To store the MIN average in register C, press [DSPL]/[1]/[5]/[8], and then select item 1 from the Ensemble Averaging Menu to start.

Both status indicators for register C light. Here, too, we see that the average minimum coincides closely with the lower edge of the MAX/MIN average. In computing the average MIN, the 256 minimum points from each max/min sweep are used.

One more to go! To store the **MEAN** value of the spectrum in register A, press [DSPL]/[1]/[4]/[8], and then select item 1 to start. At the prompt, press [W] to overwrite the previously stored max/min average.

Again, not too surprisingly, the mean value of the noise appears to be half way between the max and min values. The average **MEAN** is what you get if you add successive maximum and minimum values in dB from the MAX/MIN display, divide by two, and average the results. The **MEAN** average is a "visual mean", not a true mean. As you will see below, it can be very useful in making weak signals visible.

Turn on the D register to see the current sweep with its visual mean and average maximum and minimum values superimposed. The mean along with the max and min values provide an estimate of the variability of the signal.

Why doesn't the signal peak appear to change? Because the calibration signal is essentially constant (little or no variability), so its min, max, and mean amplitude are all about the same. This can be used to advantage. **Turn off the A, B, and C registers. Set the reference level to +10 dBm.** The calibration signal third harmonic is almost lost in the noise. **Now ensemble average the spectrum MEAN values and store the result in A.** The mean spectrum leaves little doubt as to the presence or location of the signal peak. Sometimes you can achieve even better results using the average minimum.

Experiment if you like before proceeding, then clear all registers and leave only the D register active.

400.0MHz	(AUTO SWEEP)	ATTN 10DB
-20.0DBM		VF WIDE
100.0MHz/		10 DB/
5MHz RBW (AUTO)	CALIBRATOR	

Subtracting Stored Signals

The **B,C MINUS A** feature of the Display Menu enables you to subtract a sweep stored in register A from an active sweep in registers B or C. Using it, you can flatten a noise spectrum, negate unwanted signals, and easily detect signal changes. You can probably find more uses.

Observe the current sweep, especially the zero-frequency and calibration signal peaks. In your instrument the noise floor may rise slightly with increasing frequency. **Perform a 24 sweep MAX/MIN ensemble average and store the result in A.** Wait until the ensemble is complete. Ensure item 3 of the Display Menu reads:

B,C MINUS A OFFSET TO CENTER

If it does not, select item 3 once. Then, to activate the B,C MINUS A mode, press [DSPL]/[2]. Turn on the B register and turn off A and D.

The display now consists of a much-reduced and totally flat noise floor and some intermittent peaks similar to Figure 6-6. The zero-frequency and calibration signal peaks have almost disappeared. You have subtracted the average max/min spectrum stored in the A register from the active sweep in the B register (you can also use the C register), and are displaying the result which consists only of the sweep-by-sweep variations. The vertical center of the screen represents zero amplitude difference between the waveforms.

Waveform subtraction can be used as a sensitive detector of signal changes. Suppose you were trying to measure a weak signal which you could turn on and off, in the presence of interfering noise and signals. You could turn the signal off, compile the ensemble average and subtract it as above. Then, when you turn the weak signal back on, it would show up "loud and clear" because it was not part of the stored average.

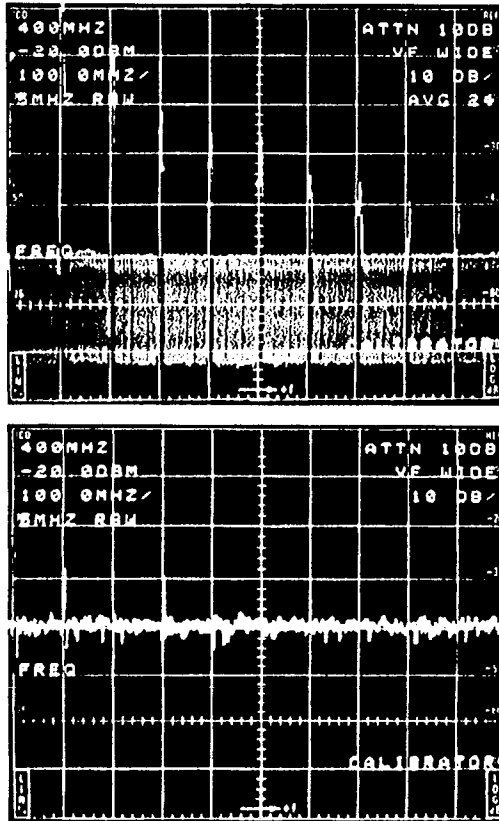

Average of calibration signal plus noise

Average of calibration signal plus noise subtracted from current sweep

Figure 6-6. Average signal plus noise and average signal-plus-noise subtracted from the current sweep.

Decrease the reference level 10 dB. See the calibration signal peaks appear? Increase the reference level 20 dB. The technique works no matter the direction of the signal change. Reset the reference level to -20 dBm and change the center frequency slightly. Again the calibration signal peaks appear. Any change from the average, either amplitude or frequency becomes obvious.

What happens if the waveform in B gets so much larger than that in A that the result goes off screen? Let's subtract the average MEAN noise from the MAX HOLD signal plus noise to find out. This provides a measure of the maximum signal variations about the mean noise level.

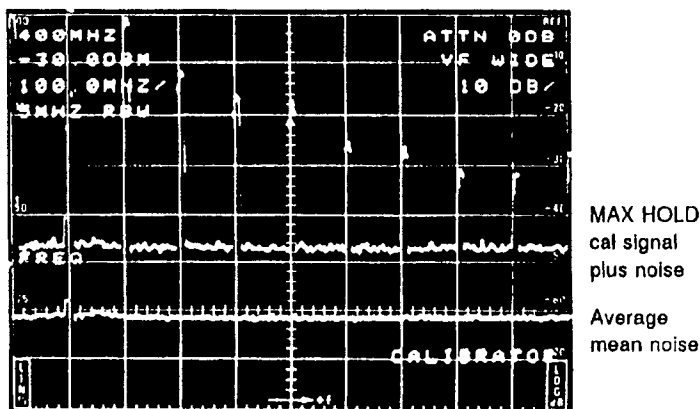
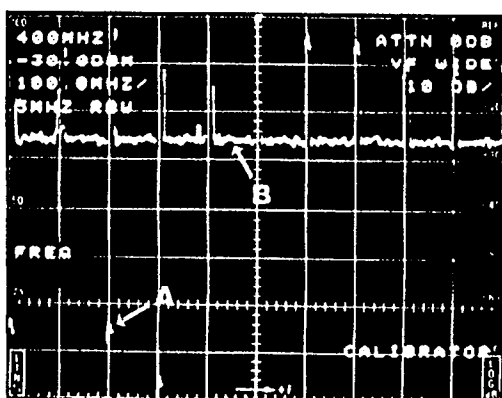

Figure 6-7. Average MEAN noise and MAX HOLD signal-plus-noise spectra.

Toggle out of **B, C MINUS A** mode ($[(DSPL)]/[2]$). Ensure the center frequency is set to 400 MHz and the reference level to -30 dBm. Now turn off the calibrator and store a 24 sweep MEAN average of the noise in register A (you will need to overwrite the display currently stored in register A). After the average is complete, turn the calibrator back on and activate MAX HOLD in register B. The resulting traces are shown in Figure 6-7.

Turn off the A register and enter **B, C MINUS A** mode. The resulting noise floor is about two divisions down from the reference level, but some of the calibration signal peaks fold over and point downward. See Figure 6-8.

Press $[(DSPL)]/[3]$. The waveform is now nearer the bottom of the screen where you can see it more clearly. You have offset the difference between the B and A register waveforms, which is always greater than zero, to the top of the screen (zero difference is at the reference level). However, because of the binary arithmetic used in the 2712, values above the reference level overflow into the sign bit of the data word and appear at the bottom of the screen! See Figure 6-9. The points labeled A and B in figures 6-8 and 6-9 have exactly the same value in each figure. Imagine that the screen curves backwards at the top and bottom until it joins itself, forming a cylinder.



Note folded-over signal peaks at 100, 200, and 300 MHz

Figure 6-8. B, C MINUS A OFFSET TO CENTER.

All points of zero difference lie along the joint. Now cut the joint and uncurl the cylinder, allowing it to become a flat screen again. Both the top and bottom of the screen represent zero difference with negative signal peaks descending from the top of the screen, and positive peaks rising from the bottom.

Experiment if you wish before proceeding, and then clear all registers, turn on register D only, turn off B,C MINUS A, and reset the B, C MINUS A offset to center.

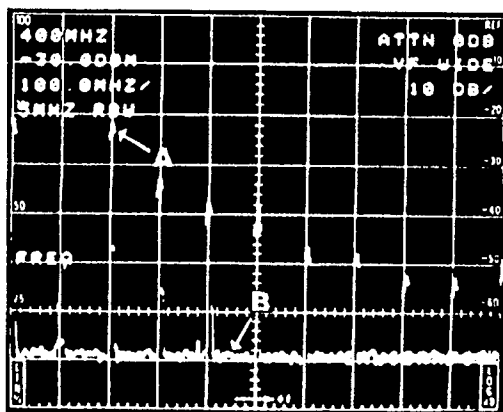

Note that signal peaks are no longer folded-over

Figure 6-9. B, C MINUS A OFFSET TO TOP.

100.0MHz	(AUTO SWEEP)	ATTN 10DB
-20.0BM		VF WIDE
20.0MHz/		10 DB/
5MHz RBW (AUTO)	CALIBRATOR	

Changing Acquisition Mode

Item 4 on the Display Menu toggles between MAX/MIN and PEAK signal acquisition modes. To change acquisition modes, press [DSPL]/[4]. Quickly toggle back and forth between MAX/MIN and PEAK several times.

Do you see that the PEAK display is essentially the top of the MAX/MIN display? The 2712 inherently produces an analog spectrum. In the MAX/MIN acquisition mode, the maximum and minimum amplitudes of this spectrum are alternately sampled at 512 successive points. Plotting the two interleaved sets, of 256 points each, produces the analog-like MAX/MIN spectrum that you see. In the PEAK acquisition mode, the maximum amplitude only is sampled and displayed at all 512 points. Which acquisition mode you choose is up to you, but the max/min mode has the advantage of bearing some semblance to the analog signal and readily revealing pulsed versus constant carrier signals -- pulsed signals cause the signal peaks to be "filled in".

For now, leave the display in MAX/MIN mode.

175.0MHz	(AUTO SWEEP)	ATTN 10DB
-20.0DBM		VF WIDE
20.0MHz/		10 DB/
5MHz RBW (AUTO)	CALIBRATOR	

Adding Titles and Labels

Suppose you want to permanently store a spectral display, either by photographing the screen or by plotting the display. It would be nice to title the display -- and you can. If you are plotting the display, you can also label significant points.

Ensure that only the D register is active, and press [DSPL]/[5]. Item 2 reads TITLE MODE EDIT if one or more

registers contain a current sweep (as now) or TITLE MODE EDIT WFM x if only saved data are displayed (saving a waveform also saves its title).

In either case, the title to be edited is always associated with the highest priority displayed waveform (see *Register Priority* in section 5). This means, for instance, that to create a title for the B waveform, the C and D registers must be turned off. Or to edit the title of a saved waveform in the C register, all registers containing a current sweep must be turned off. Although you can edit the title of a saved waveform for display or plotting, only the originally saved waveform title is retained. You can circumvent this restriction by saving the waveform and its new title as part of a stored settings group (see *Saving and Recalling Settings and Displays* later in this section); the edited title is then retained as part of the newly saved settings/waveform, and you can delete the original or not as you choose.

When performing a screen plot, the title being edited is attached to the highest priority waveform (even if it has a previously saved title). However, if titled lower priority saved waveforms exist, their titles are correctly attached to them.

The title can be up to 31 characters on a single line, and you can only title one display at a time. When title mode is turned on, the left-hand readouts move down one row to accommodate the title, even if the title field is blank. This is also a convenient way to position the readouts lower on the screen if you wish. **Select item 2 and press [W] to begin editing.** If the display is already titled, its title appears at the upper left with an underscore cursor beneath the first letter. If the display is untitled, just the cursor appears.

To edit a title, use the **FREQ/MKRS** knob to sequentially select characters; alphanumeric characters appear above the cursor as the knob is turned. Move the cursor left or right with the **[MKR ◀]** and **[MKR ▶]** keys. Delete the entire title by pressing **[Y]**.

As an example, let's create a new title "TEST123". **Rotate the knob until the letter T appears. Move the cursor one place to the right by pressing [MKR ▶]. Rotate the knob until E appears. Continue this process until you've spelled TEST.**

You can enter numbers and advance the cursor automatically without rotating the knob by using the numeric keypad. Press **[1]/[2]/[3]** to complete the title.

Go ahead and modify the title to suit yourself. When you're done, press **[X]** to store the result in the display title buffer. You can also exit from the title edit mode without saving the title or any changes by pressing **[Z]**.

To make the title visible on screen or on a plot, toggle item **1, TITLE MODE**, of the Title Mode Menu to **ON**. Toggling item **1** again turns off the title. Leave the title on, and return to the spectral display. Your title is visible in the upper left corner of the screen.

At this point, the title is associated with the highest priority waveform. Let's permanently attach it to a waveform **C**. Save the title in waveform **C** by pressing **[SAVE ENABLE]/[C]**. Now delete the title from the display title buffer by pressing **[DSPL]/[5]/[2]/[W]/[Y]**, and then return to the spectral display. The title is gone, but the readouts are displaced downward one line because **TITLE MODE** is still enabled. Now turn off the **D** register and turn on **C**. The title is back; it has become part of the saved waveform in **C**. The title will vanish from the screen if any register is turned on which contains a current sweep, but will remain in storage register **C** until waveform **C** is unsaved (**[SAVE ENABLE]/[C]**).

Now select item **4, PLOT LABELING EDIT**. Editing plot labels works the same as title editing except that the cursor can be moved vertically using any of the up or down arrow keys (**[↓]**, **[↑]**).

Press **[W]** to begin editing. Move the cursor one division to the right of center screen and two divisions down from the reference level. Enter the characters:

2ND HARMONIC

Then move the cursor to the peak at the left of the screen and label it:

FUNDAMENTAL

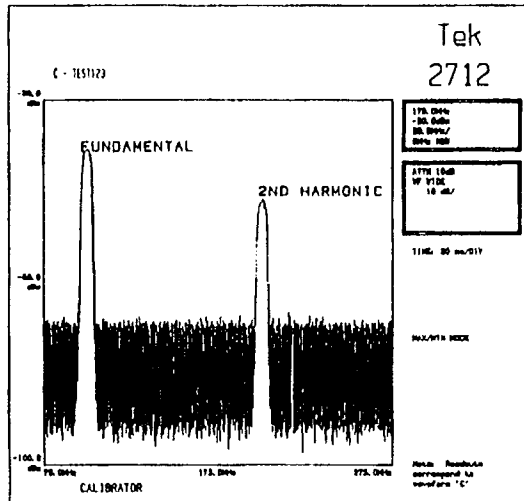

Figure 6-10. 2712 plot with title and plot labels.

The labels denote the calibrator signal and its second harmonic. Press **[X]** to store the label(s). Pressing **[Z]** exits from the procedure without any changes.

To make labels appear on your plot, select item **3** from the Title Mode Menu. Item 3 is a toggle which turns the labels on and off. Press **[DSPL]** to return to the spectral display.

NOTE

Labels only appear on the hard copy device, not on screen.

See Figure 6-10 for an example of what the plot should look like, and then turn off the title and plot labels.

Turning Graticule Illumination On and Off

Item 6 on the Display Menu is a simple toggle that turns the graticule illumination on the 2712 on and off. Press **[DSPL]/[6]** several times to see the graticule illumination change state.

Displaying an External Source

Item 7, DISPLAY SOURCE, in the Display Menu enables you to substitute an external low pass signal for the normally displayed spectrum. The signal must be input to the analyzer on pin 1 of the rear panel accessory connector J103, and must be in the range of 0 - 1.4 volts with a 3 dB bandwidth not greater than 50 kHz. DISPLAY STORAGE, VERT SCALE 10 /5 /1, SWEEP RATE, and some VID FLTR selections (10 Hz, 1 kHz, 10 kHz, 100 kHz) remain active, and can be used to process the external signal. Refer to the accessory connector discussion for additional details.

300.0MHz	(AUTO SWEEP)	ATTN 10DB
-20.0DBM		VF WIDE
50.0MHz/		10 DB/
5MHz RBW (AUTO)	CALIBRATOR	

The Display Line and Limit Detector

The 2712 provides a convenient method to determine whether a signal peak is higher or lower than some particular level, or whether it falls within a specified range. The DISPLAY LINE feature displays a horizontal line at the level you specify. You can visually compare signal amplitudes to the line, or set the 2712 to alarm audibly if a signal crosses the line.

To see the DISPLAY LINE feature in action, press [DSPL]/[8], and select item 2, VALUE ENTRY. Enter -50 dBm by pressing [5]/[0]/[W].

The 2712 reverts automatically to the spectral display which now contains a horizontal line three divisions down (-50 dBm). You'll notice the A register red LED is lit. When you display the line, you cannot display the contents of the A register. Data stored in A are not destroyed, but you cannot see them until you turn off the line.

There is another way to set the level of the line. Turn on the marker and set it at the peak of the calibration signal third

harmonic. Press **[DSPL]/[8]** again and select item **3, DISPLAY LINE TO MARKER**. The spectral display reappears with a horizontal line at the marker position. This provides a convenient way to identify all signals greater or less than another signal. If the marker is not turned on when item **3** is selected, you receive an error message.

Press **[DSPL]/[8]** again and select item **4, LIMIT DETECTOR**. The end-of-line status indicator changes to **OVER**; the display line has been made an upper limit. If an on-screen signal goes over the limit, the audio alarm sounds.

Press **[DSPL]** to return to the spectral display. The alarm should be sounding. When the limit detector and the display line are both selected, the marker automatically turns on and moves to the highest signal peak on screen. This feature enables you to quickly read the amplitude of the largest signal after the alarm alerts you that the limit has been exceeded.

Enter a new value of **-25 dBm** for the display line; the alarm should stop because all signals are now below the limit. Press **[DSPL]/[8]** and again select item **4**.

The status indicator changes to **UNDER**. The display line has now changed to a lower limit; the alarm will sound when all signals on screen are under the limit. Press **[DSPL]** to return to the spectral display. The alarm should be sounding.

Select the **LIMIT DETECTOR** once again. The status indicator changes to **OVER-UNDER**. The display line becomes an upper limit and the threshold set using **[DSPL]/[9]/[1]** becomes a lower limit.

Press **[DSPL]** to return to the spectral display. The limits are indicated by the broken horizontal line. If signals are within the limits, no alarm sounds. The alarm will sound if all signals fall below the lower limit or if one signal exceeds the upper limit.

The limit detecting features are very useful for go/no-go or yes/no type tests. They are especially useful for doing vehicular leakage surveys of cable television facilities. Set the display line to the desired number of $\text{dB}\mu\text{V/m}$, and when the alarm sounds,

note the location and magnitude (using the marker readout) of the leak for later investigation and correction.

Further, the display line/limit detector feature converts the user-definable command "WAIT FOR END OF SWEEP" to a "WAIT FOR LIMIT" command (see **USER DEF** at the end of this section). This is a handy way to halt the execution of a user-defined routine until the alarm condition has been satisfied.

If you change the reference level while using the display line/limit detector feature, the line changes position on screen to track the new reference level. Press [↓] next to [REF LEVEL] to observe this. However, the line can not be moved off screen. Continue pressing [↓] until the line reaches the top of the screen. You will receive the message

DISPLAY LINE OUT OF RANGE

Lower the line and the message will disappear.

Now turn off the limit detector by selecting **LIMIT DETECTOR** one more time, and turn off the line by toggling item 1 from the **DISPLAY LINE** Menu.

400.0MHz	(AUTO SWEEP)	ATTN 0DB
-40.0DBM		VF WIDE
20.0MHz/ 5MHz RBW (AUTO)	CALIBRATOR	10 DB

Activating Minimum Hold

Here's a trick for determining approximate upper and lower bounds on a spectrum by using the **MIN HOLD** and **MAX HOLD** features. While **MAX HOLD** is accessible by dedicated key, **MIN HOLD** can be accessed only from the Display Menu.

Call up the **DSPL** Menu and select item **9**. You will be offered a choice of storage registers for the result of the **MIN HOLD** process. Press [W] to simultaneously start the **MIN HOLD** process and select the **A** register for the result (pressing [X] or [Y] would select the **B** or **C** register, respectively, for the result).

This feature is analogous to the **MAX HOLD** function you learned to use earlier. Minimum hold compares the amplitude of the current sweep, point for point, with the stored minimum value of previous sweeps. If the current amplitude is less, the current value becomes the new stored minimum.

Now press **[MAX HOLD]/[B]** to accumulate the maximum spectrum amplitude in register B. With the A, B, and D registers displayed, you have an upper and lower bound on the real-time signal in D. As time passes, you will notice that the upper and lower bounds no longer change, because the probability of new random spectral peaks exceeding those already observed becomes very small.

Turn off the minimum hold feature by selecting item 9 again; reselecting **MIN HOLD** when it is already on toggles the feature off. Clear and turn off the A and B registers and the maximum hold feature.

100.0MHz	(AUTO SWEEP)	ATTN 10DB
-20.0DBM		VF 30KHz
100.0KHz/		10 DB/
30KHz RBW (AUTO)	CALIBRATOR	

APPL

The 2712's Applications Menu automates some routine, but often time consuming, spectral measurements. It enables you to quickly determine:

- Signal bandwidths
- Normalized noise amplitudes
- Carrier-to-noise ratios
- Occupied bandwidth
- FM deviation
- EMC emissions
- And search for signals in a specified frequency range.

Most of the items on this menu are toggles which turn the indicated measurement mode on and off. However, you can specify certain measurement parameters using item 9, **SETUP**

TABLE. Because several of the measurement modes make use of the markers, you can also exit from those modes by turning off the markers.

One of the items (**SIGNAL SEARCH**) enables the 2712 to automatically detect and catalog any signals within a specified frequency range and above a threshold which you designate. The signal amplitudes and frequencies are measured, and the results can be displayed on screen or sent to a printer.

Measuring Signal Bandwidths

The 2712 measures signal bandwidth by detecting the signal peak, and then finding the frequency points on the signal spectrum which are a designated number of dB down from the peak. You specify the number of dB using the Application Menu Setup Table. The difference between the frequency points is the bandwidth. Optimum resolution is obtained by spreading the signal across as large a portion of the screen as possible (resolution is essentially plus or minus one frequency cell or 1/512 of the total span in **PEAK** acquisition mode).

To see how to measure signal bandwidths, first change the resolution BW to 300 kHz. This provides a simulated signal several divisions wide, and equal to the width of the resolution BW filter.

Press **[APPL]**. Item 0 indicates **BANDWIDTH MODE @ -3 DB**. You're being told that by selecting this item, the 2712 will measure the bandwidth of a displayed signal at points 3 dB down from its peak amplitude.

Suppose you wish to measure the bandwidth at another point. **To change the number of dBs down from the peak at which the bandwidth is measured, select item 9, SETUP TABLE, from the Applications Menu. Choose item 0 from the Setup Table and, following the prompt, enter a value of -6 dB by pressing [6]/[-dBx].**

To implement BANDWIDTH MODE, press the backspace key to return to the Application Menu. Then select item 0.

The 2712 returns automatically to the spectral display after you press [0]. The delta markers have been activated and bracket the calibration signal peak. If the signal peak is not centered, the 2712 selects the peak nearest center screen.

The first two items in the right on-screen column read:

BW 300KHZ
@ -6DBC

You are measuring the bandwidth of the resolution BW filter. Don't worry if the indicated bandwidth is not exactly 300 kHz; it will vary slightly either side of 300 kHz.

Change the span to 10 kHz/division and the resolution BW to 30 kHz. The bandwidth should now read roughly 30 kHz.

The 2712 remains in bandwidth mode until you call up the Applications Menu and toggle it off, make an alternate selection, or until you turn off the markers. **Turn off bandwidth mode by pressing [APPL]/[0].**

100.0MHz	(AUTO SWEEP)	ATTN 10DB
-30.0DBM		VF WIDE
20.0MHz/		10 DB/
5MHz RBW (AUTO)		

Measuring Average Noise

Item 2 of the Applications Menu causes the 2712 to measure the average noise at the marker location and normalize it to a specified bandwidth. The default bandwidth is 1 Hz, but you can change it to suit your application. If you're in the CATV business (in the USA), you'll probably use 4 MHz. For now, let's change it to 5 MHz to obtain an approximation of the analyzer's noise floor.

Press [APPL] and then select item 9 from the Applications Menu. Choose item 2, **NOISE NORM'D BW**, from the Setup Table. Enter a value of 5 MHz and return to the Applications Menu by pressing [BKSP]. Choose item 2, **NOISE NORM'D**.

The spectral display reappears and the marker is turned on. The first two items in the right on-screen column read:

**N -93.0DBM
@ 5.0MHZ**

Your instrument's reading may vary somewhat. The reading is the analyzer's average internal noise in a 5 MHz band at the marker frequency. You will also receive the warning:

NOISE LEVEL LESS THAN 2DB

This is because the analyzer recognizes when the noise it is measuring approaches its own noise floor. It knows that it can not accurately measure external signals too close to that value.

Ensure that your analyzer is in MAX/MIN display mode, and using the FREQ/MKRS knob, reposition the marker at the bottom of the displayed noise. Notice that the noise amplitude readout does not change significantly.

The noise amplitude appears to be about -- but not exactly -- half way between the max and min values of the spectral display. Here is why. The 2712 doesn't compute the arithmetic mean of the min and max values using decibels (that yields an incorrect answer). Rather, the 2712 measures the average noise amplitude "behind the scene". The display doesn't change, but you may notice a pause while the 2712 carries out the noise measuring algorithm. First, the analyzer measures the average noise power in ZERO SPAN using a narrow bandwidth video filter (see a better approximation of the average noise by pressing [VID FLTR]). It then corrects the measured value for the difference between average and RMS amplitudes. More corrections are added for the effects of log amplification, and to account for the equivalent noise bandwidth of the resolution BW filter not being exactly 5 MHz. The resulting noise is then normalized to the specified bandwidth.

Now turn off the markers and the video filter.

Measuring Carrier-To-Noise Ratios

To demonstrate the carrier-to-noise (C/N) ratio feature of the 2712 we will measure the calibrator-to-analyzer-noise-floor ratio in a 5 MHz bandwidth. In the real world, you are more likely to measure a carrier peak to system noise ratio, but the technique is the same.

Turn on the calibrator. Then call up the Application Menu, and select the Setup Table. Choose item 1, NORM BW FOR C/N, and again enter 5 MHz for the noise bandwidth for the carrier-to-noise (C/N) measurement. Return to the Application Menu and select item 1 to turn on the C/N feature.

The spectral display reappears with the fixed marker atop the 100 MHz signal peak (the 2712 places the fixed marker on the signal peak nearest the center of the screen in C/N mode). The moveable marker appears 1 division from the left screen edge.

Reposition the moveable marker 50 MHz above the signal.

NOTE

The moveable marker is initially positioned only to clearly separate it from the fixed marker. You must place the noise marker at the frequency where you want the noise measured.

The first two items in the right on-screen column read:

**C/N 63.0DB
@ 5.0MHZ**

Your instrument's reading may vary slightly. You will also receive the "NOISE LEVEL LESS THAN 2DB" warning that was discussed in the previous section.

The C/N reading is the ratio of the signal power at the fixed marker's position to the average noise power at the movable

marker position. The noise reading is corrected as indicated in the normalized noise measurement section. Since the noise level you measured earlier was about -93 dBm and the signal peak is -30 dBm, the ratio should be approximately 63 dB.

The preamplifier discussed in the Input Menu section of this chapter can be very important when making noise or C/N measurements in broadband networks. For instance, in the U.S., good cable television operating practice requires that the video signal be at least 0 dBmV while picture quality requires the noise to be about 45 dB lower, or about -45 dBmV in a 4 MHz band. **Change the reference units to dBmV and reset the noise bandwidth to 4 MHz. Select NOISE NORM'D and notice the measured noise is about -42 dBmV.** If we were to connect the 2712 to a cable television tap with a 0 dBmV video signal and a 45 dB C/N, we would be unable to measure the noise or C/N because the cable noise (-45 dBmV in this example) is below the normal analyzer noise floor.

Using the Input Menu, turn off the calibrator, turn on the preamplifier, and set the RF attenuation to zero. Notice the analyzer noise floor has been reduced by over 12 dB to about -55 dBmV, making it possible to measure both noise and C/N on our hypothetical cable.

Turn off the preamp and noise measurement mode.

Re-initialize the analyzer to the factory default power-up settings.

NOTE

If the 2712 is in PEAK acquisition mode, it reverts to MAX/MIN mode whenever the normalized noise or carrier-to-noise features are activated. You can return it to PEAK mode by pressing [DSPL]/[4].

900.0MHz	(AUTO SWEEP)	ATTN 50DB
20.0DBM		VF WIDE
180MHz/MAX		10 DB/
5MHz RBW(AUTO)		

Searching For Signals

The 2712 provides a signal search feature that enables you to detect signal peaks over a wide frequency range while still using a narrow span and/or resolution BW. The analyzer sequentially implements a series of searches using the marker peak find capability, and the span and resolution BW that you specify using the Signal Search Menu. Each search range is equal to 10 times the specified span/div, but each search range except the first overlaps the previous range by one division. The first search starts at the beginning frequency and the last stops at, or overlaps, the end frequency as indicated in Figure 6-11. Although the last search range may overlap the end frequency, no signals are reported above the end frequency. A verification process looks at the entire range twice and reports only those signals which are present both times.

To see how **SIGNAL SEARCH** works, turn on the calibrator and reset the following analyzer controls:

SPAN/DIV	5.0MHz
RESOLUTION BW	300.0KHz
REFERENCE LEVEL	-20.0DBM
VIDEO FILTER	300.0KHz

We will search the frequency range from 55 to 550 MHz. Press **[APPL]**, and select item **3, SIGNAL SEARCH MENU**. Choose item **0, BEGIN FREQ**, and enter **55 MHz**. Then choose item **1, END FREQ**, and enter **550 MHz**. The frequency and amplitude of all signals within the specified frequency range that are below the reference level but above the threshold are stored. The threshold is normally set by the 2712 at about one division above the lowest signal peaks (usually noise), but you can reset it manually if desired via **[MKR/FREQ]/[0]**. See *Setting the Signal Threshold* in this section for details.

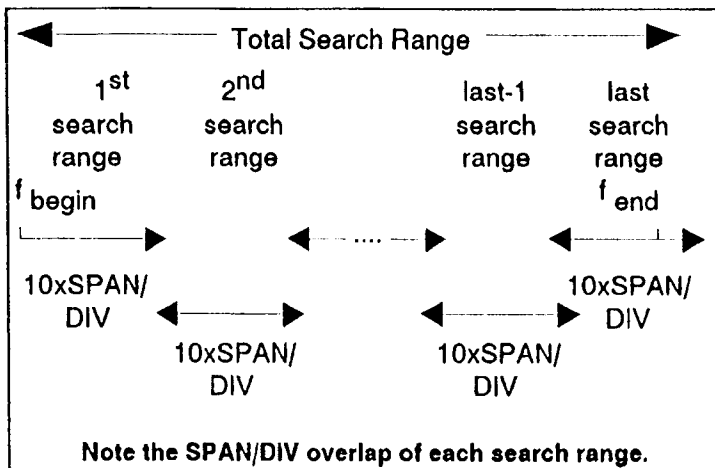

Figure 6-11. The SIGNAL SEARCH frequency range.

Start the search by selecting item 2, **START TEST**. You will see the measurement parameters change, and the message:

SIGNAL SEARCH IN PROCESS

is displayed while the search is occurring. You will also notice the center frequency change as each search range is completed. When the search is complete, the message disappears and the analyzer is reset to its original measurement parameters.

Press **[UTIL]/[4]/[2]**, and then press **[0]** until the status indicator reads **CRT** (this feature is explained in the **UTIL** discussion later in this section). Press **[UTIL]** again, and then reselect the **SIGNAL SEARCH MENU** from the Application Menu. Notice that the number of signals detected is displayed at the end of item 3, **DISPLAY RESULTS**. Select item 3.

The **SIGNAL SEARCH RESULTS** table appears. Five signals are listed (the calibration signal fundamental and its first four harmonics). The amplitude and frequency of each are indicated.

Return to the spectral display by pressing **[APPL]**.

100.0MHz	(AUTO SWEEP)	ATTN 10DB
-20.0DBM		VF 300KHz
1.0MHz/		10 DB/
300KHz RBW (AUTO)		

Measuring Occupied Bandwidths (OBW)

Measuring occupied bandwidths is similar to measuring signal bandwidths, except that the 2712 determines the bandwidth that contains $n\%$ of the signal's energy rather than the bandwidth enclosed by the x dB down points.

To determine the occupied bandwidth, the 2712 first sums the signal power in all 512 frequency cells of the displayed spectrum, ignoring any contributions more than 40 dB below the signal peak. This is the total displayed signal power, P_t . It then sums the power in the cells starting at the left-hand edge of the screen until the accumulated power equals or exceeds:

$$P_t \times \frac{1}{2} \left(1 - \frac{n}{100}\right)$$

P_t = total signal power

n = percentage of signal power within the occupied BW

It then performs a similar calculation starting at the right-hand screen edge. That is, it finds the frequency cells, both above and below the signal, beyond which half the power not-in-the-occupied BW resides. The frequency difference between the upper and lower cells is the $n\%$ occupied bandwidth.

For instance, if you specify the 90% occupied bandwidth, the 2712 first computes the total signal power, and then sums the signal power in the cells starting at the left-hand edge until it accumulates 5% of the total (the percent signal power not-in-the-occupied BW is $100\% - 90\% = 10\%$, and half of it is below, and half above, the occupied BW). See Figure 6-12.

If the accumulated power does not precisely equal half the power not-in-the-occupied BW (the usual case), the 2712

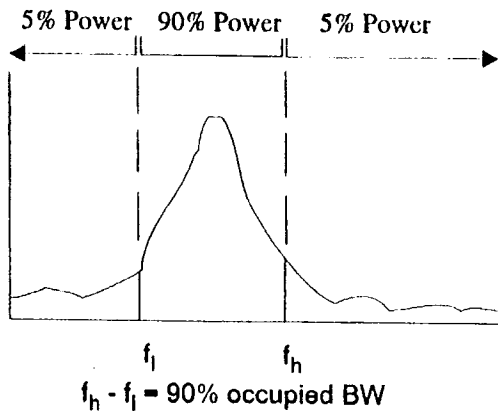

Figure 6-12. Illustration of Occupied BW measurement.

linearly interpolates between frequency cells to arrive at better frequency estimates.

But remember this: the occupied BW mode always works on the digitally sampled signal. Therefore, different results can be obtained in **PEAK** and **MAX/MIN** modes unless video filtering is used to minimize post-detection noise.

You can demonstrate occupied BW mode with the calibration signal, but it is more interesting to use a broadcast signal.

Ensure the calibrator is turned off and connect a short antenna or CATV tap to the analyzer input as outlined in Appendix A. Adjust the reference level until you can see individual FM broadcast or TV sound carrier signal peaks and then tune the analyzer until a strong signal is centered. Your display might resemble Figure 6-13.

Press **[BKSP]** to return to the Applications Menu, and choose item **4, OCCUPIED BW**. The spectral display reappears with both markers active. Set the span to **25 kHz/div**, and recenter the signal if necessary.

The right-hand data column will display something similar to:

**OBW 57.36KHZ
@ 90%**

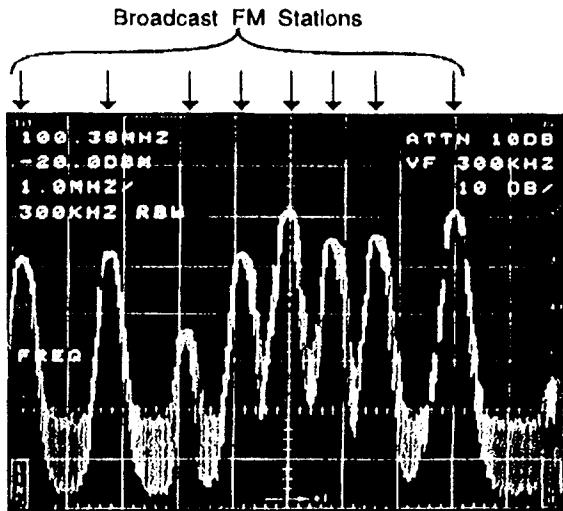

Figure 6-13. Portion of U.S. broadcast FM band.

Because the signal varies considerably from sweep to sweep, the markers jump around the screen and you will not get a consistent occupied BW reading.

Activate MAX HOLD in register B and turn off register D. Remember, the markers are present only on the highest priority waveform. In a short time a broad spectral peak develops, and the OBW reading begins to settle to a constant value. Figure 6-14 shows a typical MAX HOLD waveform from an FM stereo broadcast. The relatively sharp skirts near ± 70 kHz denote the upper and lower limits of frequency deviation.

To obtain best frequency accuracy when making occupied BW measurements, as with signal bandwidth measurements, use small spans/division (spread the signal over as much of the screen as possible) subject to the following limitations:

- The signal spectrum at the edges of the screen should be down at least 40 dB from its peak.
- The signal peak should be at least 40 dB greater than the displayed noise.

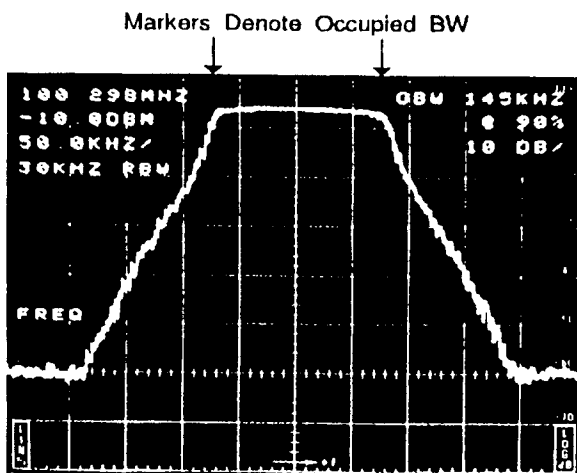

Figure 6-14. OCCUPIED BW mode with MAX HOLD.

- The resolution BW filter must be 1/5 or less of the occupied BW. A resolution BW filter that is too wide will artificially broaden the occupied BW (remember how the 5 MHz resolution BW filter made the cal signal look like it is 5 MHz wide?).
- Only vertical scales of 5 or 10 dB/div can be used.
- There should be no signal on screen except the desired signal. Other signals, including the zero Hertz spur, will contribute some inaccuracy.

For optimum amplitude accuracy, keep the signal peak near the reference level.

Experiment if you wish, and then turn off **OCCUPIED BW mode, MAX HOLD A & B, and register B**. OBW mode can be turned off by again pressing ([APPL]/[4]), or by turning off all display registers.

Turn register D back on.

100.0MHz	(AUTO SWEEP)	ATTN 0DB
-30.0DBM		VF 300KHz
1.0MHz/		10 DB/
300KHz RBW (AUTO)	CALIBRATOR	

Making EMI/EMC Measurements

Electrical equipment often generates undesired electro-magnetic signals, and is itself subject to interference from undesired externally and internally generated signals. Measuring the signals generated by a piece of equipment (its emission) and its immunity, or lack of, to interfering signals (its susceptibility) is called electromagnetic compatibility (EMC) testing. Measuring the electromagnetic environment itself for interfering signals is sometimes referred to as electromagnetic interference (EMI) testing.

A 2712 equipped with Option 12 enables you to make EMI and EMC measurements in peak mode using conventional resolution BW filters or optional EMC filters, or in quasi-peak (QP) mode using the EMC filters.

EMI signals are frequently impulse-like in nature, being high in amplitude and short in duration. These characteristics are somewhat different than those for which a heterodyne analyzer is normally optimized. Consider, for instance, a signal consisting of a 0.1 μ sec pulse repeated 100 times per second with an average power of 0 dBm. It would seem that the 2712 could handle this without any trouble. However, that pulse represents a peak amplitude of 70 volts across 50 ohms -- several times the 1 dB compression point of the analyzer! Its duty cycle is sufficiently small that the analyzer won't be damaged, but its indicated spectrum would be erroneous because the 2712 is being driven into saturation.

To accommodate impulse-like signals, the Applications Menu provides a special **EMC MODE**. This mode re-distributes the 2712's pre- and post-detection gains in order to supply the pulse "head room" needed for EMC and other pulse measurements.

Pulses of up to +53 dBm peak power can be accommodated with 1 dB or less compression. Remember, though, that the average input power must remain $\leq +20$ dBm.

Although the feature is called **EMC MODE**, it should be considered for use anytime a high-amplitude pulsing signal with small duty cycle is being measured.

NOTE

In some cases you may wish to measure pulses which exceed even the +53 dBm maximum compression-free amplitude tolerated by the **EMC MODE**. In these cases, pre-filtering can be used to reduce the peak signal energy without reducing the amplitudes of the signal components within the band of interest.

You must use **EMC MODE** when making quasi-peak measurements. However, the mode can be activated independently of quasi-peak detection, so you can make EMC or other pulse measurements using the 2712's normal peak detector. Peak detector measurements do not require long time constants, so they are much faster than quasi-peak measurements, and enable you to use larger spans. Peak mode testing is often used to quickly identify potential problems prior to more extensive quasi-peak testing.

It is assumed that if EMC mode is active, pulse-like (wide-band) signals are being measured. Hence, to ensure optimum pulse accuracy, wider than normal post-detection filtering is used. See Table 6-2. Notice that while the user-enabled video filters (**ON**) remain the same as normal, the 2712-selected post-detection filters (**OFF**) are several times wider than normal in EMC mode (note that quasi-peak operation also alters video filter selection).

Ensure that your analyzer is set according to the preceding settings box. Observe that the calibration signal peak is at the reference level, and note the noise level.

Table 6-2. Video filter selection in EMC and QP modes.

RBW	Normal		EMC		QP	
	ON	OFF	ON	OFF	ON	OFF
200 Hz	10 Hz	300 Hz	10 Hz	3 kHz	30 Hz	3 kHz
1 kHz	10 Hz	1 kHz	10 Hz	3 kHz	*	*
3 kHz	30 Hz	3 kHz	30 Hz	10 kHz	*	*
9 kHz	100 Hz	10 kHz	100 Hz	30 kHz	3 kHz	30 kHz
30 kHz	300 Hz	30 kHz	300 Hz	100 kHz	*	*
120 kHz	1 kHz	300 kHz	1 kHz	300 kHz	30 kHz	300 kHz
300 kHz	3 kHz	300 kHz	3 kHz	WIDE	*	*
1 MHz	10 kHz	WIDE	10 kHz	WIDE	*	*
5 MHz	30 kHz	WIDE	30 kHz	WIDE	*	*

* Not available in QP mode.

Press **[APPL]** and then select item **5, EMC MODE** from the Applications Menu. Press **[APPL]** once again to return to the spectral display. Observe that the calibration signal peak remains at the reference level, but both the **RF attenuation and the noise floor have increased.**

By changing the RF attenuation at the analyzer input and simultaneously redistributing the IF and post-log-amplifier gains it was possible to increase the "headroom" between the analyzer's pulse compression point and the reference level to more than 50 dB (CISPR requires 43.5 dB). A consequence of the gain redistribution is that the analyzer noise floor is increased; the log amp input noise becomes the limiting noise source in some cases rather than the thermal noise at the first mixer input. Hence, you may not see the displayed noise change as $10 \log(\text{RBW})$ except in the case of the widest RBW filters, or at the lowest reference level settings. The reference level range is also changed from +20 — -70 dBm to 0 — -90dBm. Some dynamic range is sacrificed, but the reference level-to-noise ratio remains about 40 dB when using the 120 kHz EMC filter. Table 6-3 shows how the 2712 typically differs in normal and EMC modes.

Table 6-3. Typical 2712 parameters in normal and EMC modes.

Mode	NORMAL	EMC
1 st mixer power input for 1dB compression	-15dBm	+3dBm
min noise floor	10 log (resBW)-152	10 log (resBW)-152
max RF attenuation	50dB	50dB
max ref level	+20dBm	0dBm
min ref level	-70dBm	-90dBm
max peak signal for 1dB compression*	+35dBm (with 50 dB RF atten)	+53dBm (with 50 dB RF atten)
min headroom (max signal - ref level)	+15dB	+53dB
max duty cycle to prevent damage to input, $d = (t_{on}/t_{off})$	$d < 10^{-2}$	$d < 5 \times 10^{-4}$

* Average signal power must be $\leq +20$ dBm to prevent damage to 2712 (signals with peak powers greater than +20 dBm must satisfy duty cycle requirements in this table).

Quasi-Peak Measurements (Option 12 only)

The International Special Committee on Radio Interference (CISPR) has established EMC specifications based on measurements made with a quasi-peak detector (a voltage detector with specified charge and discharge times) and filters of particular bandwidths and shapes that depend on the frequency band being examined. Four bands with three corresponding filters are defined:

Band A: 10 kHz - 150 kHz
200 Hz filter bandwidth

Band B: 150 kHz - 30 MHz
9 kHz filter bandwidth

Bands C and D: 30 - 300 MHz and 300 MHz - 1 GHz
120 kHz filter bandwidth

The 2712 enables you to make pre-certification quasi-peak measurements if Option 12 is installed (if in doubt, press [UTIL]/[4]/[9] to see an on-screen list of the installed options). Option 12 provides a quasi-peak detector and three EMC filters with 6 dB resolution BWs of 200 Hz, 9 kHz, and 120 kHz. Furthermore, quasi-peak measurements are made only in EMC MODE to provide the necessary headroom for the impulse-like

signals that often constitute electromagnetic interference. The output of the 2712's QP detector is always less than the analyzer's normal peak detector output for pulsing signals, but approaches the peak detector output as the signal repetition rate increases, and equals the output of the peak detector when the signal is continuous. That is, sporadic or infrequently pulsing signals are weighted less than CW signals or frequently occurring pulses.

The QP detector has very long charge and discharge times. Hence, sweep rates and corresponding spans per division that allow calibrated measurements of all signals including CW and high repetition rate pulses are limited. See Table 6-4. Larger spans or faster sweep rates will result in an UNCAL message. However, spans can sometimes be increased by 10 times or more when measuring narrow pulses (pulsewidth $\ll 1/\text{RBW}$) with repetition rates below 10 kHz, the norm for many EMI signals. The UNCAL indicator will remain on, but you can quickly compare wide and narrow span results to see if they differ. Further, the limits in Table 6-4 are usually not a problem during an EMC measurement session. Typically, you first scan a relatively broad spectrum in normal peak mode to identify potential problem areas (remember, the peak mode readings will always be greater than or equal to the QP measurements). Then reduce the span, and make QP measurements at the frequencies of interest. Alternately, you can make QP measurements with the UNCAL indicator on, and then reduce the span to be certain you've obtained calibrated measurements. You will find that in many cases there is no difference.

Only the EMC filters can be used in QP mode. The post-detection filtering is the same that is used in EMC mode when the user-selectable video filter is not active. When the user-selectable video filter is enabled, the video filter bandwidths are as shown in Table 6-2. The video filter can be useful in QP mode for determining whether a signal is narrow or wideband; the displayed amplitude of a narrowband signal will not change when the video filter is enabled.

To use quasi-peak detector, first call up the Applications Menu. QUASI-PEAK is item 6 (QUASI-PEAK is present on the Applications Menu only if Option 12 is installed). The end

Table 6-4. Maximum spans/div and total spans in QP mode.

EMC Filter Bandwidth	Max Span/Div	Max Total Span	Max Sweep Rate
120 kHz	100 kHz	1 MHz	2 sec
9 kHz	10 kHz	100 kHz	2 sec
200 Hz	Zero Span	Single Frequency	NA

NOTE

The auto filter width corresponds to the CISPR band in which the analyzer center frequency falls. If the displayed frequency range crosses a band edge, the filter bandwidth is not changed. Choose center frequencies and spans to avoid this situation.

of the line indicates the EMC filter that will be used; it should be displaying **AUTO 120KHZ FLTR**. Had the center frequency been in band A or B, the end of the line would indicate **AUTO 200 HZ FLTR** or **AUTO 9 KHZ FLTR** respectively.

Ensure EMC MODE is active ([APPL]/[5]) and then select item [6], QUASI-PEAK, from the Applications Menu.

The spectral display reappears, and several changes are apparent:

- The resolution BW is now 120 kHz.
- The shape of the calibration signal is distorted, and the "UNCAL" message is displayed. The distortion is the result of sweeping far too fast for the QP time constant. **Reduce the span/div a step at a time and watch the cal signal evolve to a symmetric shape. Stop at 100 kHz/div (when the "UNCAL" message disappears).**
- The calibration signal amplitude is unchanged, and the noise level equals the peak of the max/min display. This is because both the cal signal and analyzer self-noise are continuous signals, and should indicate the same with either a peak or quasi-peak detector. You can verify this by returning to EMC MODE, turning on the B register and saving the EMC MODE measurement in it, and then restoring QP mode -- the QP curve will trace the top of the EMC max/min display.

To change to another EMC filter (rather than the AUTO-selected filter) regardless of the measurement band, press the \uparrow or \downarrow keys in the RES BW function block. Alternately, you can select the Setup Table from the Applications Menu, and, under the sub-heading QUASI-PEAK, choose item 5, 6, or 7 to select the filter you want to use. If QUASI-PEAK is already selected, return to the spectral display by pressing a menu key; otherwise press [BKSP] to return to the Applications Menu to select QUASI-PEAK.

The chosen filter will be used whenever QUASI-PEAK mode is entered until you change it, press [AUTO] in the RES BW function block, or reselect item 4, AUTO, from the Applications Menu Setup Table.

You can exit from QUASI-PEAK mode in three ways:

- Press [APPL]/[6] to exit QP mode, and reset the 2712 to EMC MODE.
- Press [APPL]/[5] to exit EMC and QP modes, and reset the 2712 to the mode it was in before selecting EMC MODE.
- Select an alternate display mode (EXTERNAL, FM DEVIATION)

Call up the Applications Menu and reselect QUASI-PEAK to toggle out of QP mode. Notice that the resolution BW filter remains set to 120 kHz. Enable automatic resolution BW filter selection by pressing [AUTO] in the RES BW function block. Exit EMC mode by pressing [APPL]/[5].

You can use this procedure to verify the operation of QP mode with pulsing signals:

1. Set up a pulse generator as follows:
 - Pulse repetition rate: 100 Hz
 - Pulse width: 1 μ sec
 - Pulse amplitude: 2 V
2. Set up the 2712 as follows:
 - Span/div: 100 kHz
 - Center freq: 15.5 MHz
 - Resolution BW: 9 kHz
 - Reference level: -60 dBm
3. Place the 2712 in EMC mode with the vertical scale set to

5 dB/div, and connect the pulse signal. Place a marker on the signal peak and verify the indicated amplitude is -55 to -63 dBm.

4. Turn on QP mode and verify the signal level falls 2 to 8 dB from the previous step.
5. Change the pulse repetition rate to 20 Hz and verify the signal level falls 3.5 to 9.5 dB more.
6. Reduce the repetition rate to 10 Hz and verify the signal level is 6.5 to 13.5 dB below that in step 4.
7. Increase the repetition rate to 1 kHz and verify the signal level is 1.5 to 7.5 dB greater than in step 4.
8. Procedure complete. Continue with other measurements.

For other tools and techniques which may be useful for EMC/EMI measurements, consult these topics in sections 5 and 6:

Changing Reference Level Units

Accommodating External Amplification/Attenuation

Turning the Preamplifier On and Off

Using the DBUV/M

Max Hold A & B

The Display Line and Limit Detector

Searching for Signals

100.0MHz	(AUTO SWEEP)	ATTN 10DB
-20.0DBM		VF 300KHz
1.0MHz/		10 DB/
300KHz RBW (AUTO)		

Viewing Instantaneous Frequency Deviation

Normally, the display you see on the 2712 represents the input signal after it has been AM detected. The result is a conventional spectral display of signal power vs. frequency. However, by selecting **FM DEVIATION MODE**, you can view instantaneous frequency variations vs. time.

You need a frequency modulated signal to demonstrate this mode. **Ensure the calibrator is turned off, and connect a short antenna or CATV tap to the analyzer input as outlined in Appendix A. Adjust the reference level until you**

can see individual FM broadcast or TV sound carrier signal peaks and then tune the analyzer until a strong signal is centered. Your display might resemble Figure 6-13 from the *Measuring Occupied Bandwidths* discussion.

Change the span to 100 kHz/div. Press [APPL] and select Item 7, FM DEVIATION, from the Applications Menu.

The 2712 reverts to a waveform display mode in zero span. The bottom line of the right column reads:

FM 10 KHz/

indicating that FM demodulation is now being used, and that the vertical scale factor has changed to 10 kHz/division -- the vertical axis now measures frequency deviation!

The sweep being displayed should resemble the upper trace in Figure 6-15. It is an approximate indication of the instantaneous frequency deviation.

The vertical scale can be changed in a 10-5-1 kHz/ division sequence. **Cycle through the frequency deviation scales by repeatedly pressing [10 /5/1].**

Want to check the maximum deviation? Set the vertical scale to 10 kHz/division, and using the Display Menu, select MIN HOLD IN WFM A. Let the data accumulate for 2-3 minutes. A ragged horizontal waveform develops indicating the maximum frequency excursions during the observation period. To read out the frequency deviation with the marker, turn the marker on and leave only the A register active. Move the marker to the point where you want the measurement.

NOTE

Because of the FM demodulator bandwidth, the modulating signal used in deviation monitor mode should consist of normal program material or a single tone in the audio frequency range.

The foregoing technique provides a quick look at unidirectional frequency deviation. The carrier frequency is at the

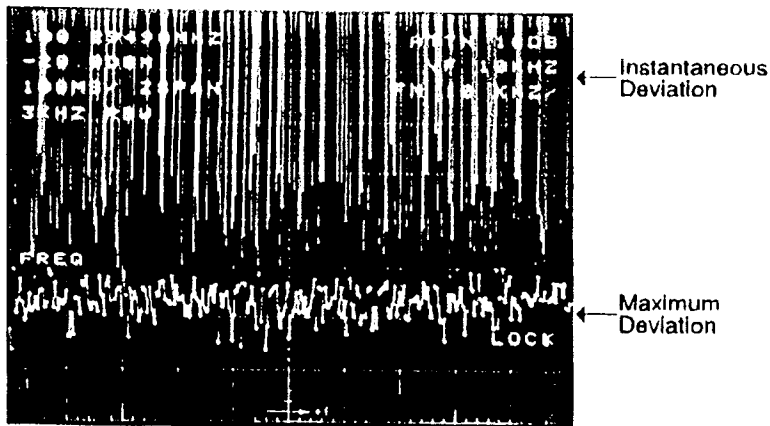

Figure 6-15. Instantaneous frequency deviation and maximum observed deviation.

reference level, and a downward excursion represents a deviation below the carrier. If the FM spectrum is symmetrical, the peak to peak deviation is twice the unidirectional amount. In the example above, 7 divisions is 70 kHz (at 10 kHz/div), and the peak to peak deviation is about 140 kHz.

To see the deviation in both directions, try the MAX HOLD technique outlined in *Measuring Occupied Band-widths*. For extremely accurate deviation measurements, the Bessel null approach should be used. See *Spectrum Analyzer Fundamentals*, Tektronix application note 26W-7037-1

100.0MHz	(AUTO SWEEP)	ATTN 50DB
-20.0DBM		VF 300KHz
1.0MHz/		10 DB/
300KHz RBW (AUTO)		

DEMODO

/TG



The DEMODO/TG Menu provides means of listening to AM or FM modulation on the signals being analyzed, activating video monitor mode (Option 10), and controlling the built-in tracking generator (Option 04).

Listening to FM Transmissions

Listening to signals often helps to identify the source. A built-in speaker is provided, but if higher fidelity is needed, or you are using the 2712 in a noisy location, headphones can be used. A 1/8" miniature phone jack is located near the front of the right side of the analyzer. Stereo decoding is not supported.

To experiment with the FM demodulator, connect an antenna or cable to the 2712 as outlined in *Appendix A*. Change the signal height and center frequency until you see signal peaks in the 88 - 108 MHz FM broadcast band (if you don't have broadcast FM in your area, you can tune to a TV station audio carrier). Set the center frequency to coincide with one of the peaks and press:

[DEMOD/TG]

The DEMOD/TG Menu appears. Select item **2, FM DEMODULATOR**. The LED adjacent to FM VOL on the front panel lights, the spectral display reappears, and you may hear the analyzer sweeping. **If you hear nothing, turn the outer barrel of the LEVEL control.** Turning clockwise increases the volume. Press **[ZERO SPAN]** to hear whatever is being transmitted by the station. Leave the analyzer in zero span, and tune it as you would a radio receiver, using the **FREQ/MKRS** knob. The signal level rises as you tune-in stations and falls to the noise floor when no station is present.

When you're finished, turn off the FM demodulator by selecting item 0, OFF, from the Demod/TG Menu and press [ZERO SPAN] to return to the normal spectral display.

Listening to AM Transmissions

To listen to AM transmissions, connect an antenna to the 2712 as outlined in *Appendix A*. The antenna will probably need to be much longer than for FM. Set the center frequency to 1 MHz, span to 10 kHz/division, sweep and resolution BW to AUTO, and calibrator off. Increase the signal height until you can see signal peaks in the 500 kHz - 1.6 MHz area

(this is the medium-wave broadcast band). Change the center frequency until one of the peaks is centered. Press **[DEMOD/TG]**, and select item **1, AM DEMODULATOR**. The LED adjacent to **AM VOL** on the front panel lights, and the spectral display reappears. Press **[ZERO SPAN]** and adjust the **LEVEL** control as needed. You'll hear whatever is being transmitted by the station.

Leave the analyzer in zero span, and use the **FREQ/MKRS** knob to tune other stations. When you're finished, turn off the AM demodulator by selecting item **0, OFF** from the **DEMOD/TG** Menu.

Listening to FM or AM Transmissions

To hear AM and FM stations, select **AM DEMODULATOR** and **FM DEMODULATOR** simultaneously (both **AM VOL** and **FM VOL** LEDs will light). This approach is convenient if you don't know whether the signal is AM or FM, or for simply finding audio modulated signals and then switching on only the AM or FM demodulator to determine which type of modulation is being used.

100.0MHz	(AUTO SWEEP)	ATTN 10DB
-20.0DBM		VF 300KHz
1.0MHz/		10 DB/
300KHz RBW (AUTO)		

Video Demodulation (Option 10 only)

The video demodulator (Option 10) enables you to view broadcast or satellite video transmissions. This is useful for identifying signals, and determining the nature of interference.

Call up the **Demod/TG** Menu. Item 3 is an on/off toggle which may indicate **BROADCAST (AM) VIDEO** or **SATELLITE (FM) VIDEO**, depending on the mode which was last selected. The **BROADCAST** mode is used for off-air or cable TV signals; **SATELLITE** is used, for example, when viewing FM video signals at the output of a block down converter (LNB). In

the following example we will use the AM monitor mode to view an off-air or cable TV signal, but remember that **SATELLITE** can be very useful when identifying transponder signals. First, some cautions:

- The carrier-to-noise ratio (C/N) must be sufficiently large - at least 30 dB in a 4 MHz bandwidth in **BROADCAST** mode (10 dB in a 30 MHz bandwidth in **SATELLITE** mode), but it is possible to get a poor quality display at slightly lower C/N's.
- You will not be able to satisfactorily monitor "scrambled" or sync-less signals in either mode.
- The video carrier in either mode should be placed at the reference level for satisfactory operation.
- Energy dispersal dithering is generally not a problem in **SATELLITE** mode.

To continue with the example, select item **9, VIDEO SETUP TABLE**, from the **DEMOD/TG** Menu. Toggle item **0** of the Setup Table to **BROADCAST** mode. Then toggle items **1** and **2** to the proper polarities. If you don't know the polarity, set **SYNC POLARITY** to **POSITIVE** and **VIDEO POLARITY** to **NEGATIVE**. These are the standards for normal U.S. broadcast television. You can change them later to accommodate other standards if the video is inverted or sync cannot be achieved.

Return to the spectral display. Connect an antenna or cable drop to the analyzer as outlined in Appendix A and tune to a strong video carrier (choose an unscrambled channel). Adjust the reference level until the signal peak is at the top line. The signal level is very important for proper performance¹, and must also be well above the noise floor.

Call up the Demod/TG Menu and choose item 3, BROADCAST (AM) VIDEO. Presto, a TV picture! When item 3 is activated, the 2712 presets a number of measurement

¹ This can be conveniently done by placing the marker atop the video carrier and selecting item **3, MARKER TO REFERENCE LEVEL**, from the **MKR/FREQ** Menu.



Figure 6-16. 2712 screen in video monitor mode.

parameters in order to generate a TV picture. You may be able to obtain a slightly better picture by changing some settings. **Vary the reference level (use the 1 dB step size) and experiment with the INTENSITY control to obtain optimum contrast. Use the inner knob of the LEVEL control to change vertical size and obtain a flicker-free display. Use the SWEEP arrow keys to change horizontal size.**

Figure 6-16 shows a typical 2712 monitor mode display with good C/N. Being able to view a TV picture is useful not only for station identification, but also to observe interfering signals and modulation problems.

Turn off the video monitor by toggling item 3 of the Demodulator/TG Menu to OFF. When the monitor is disabled, the settings used prior to entering monitor mode are restored; any changes you've made while using the video monitor are forgotten.

Reinitialize your instrument (press [UTIL]/[1]/[1]).

900.0MHZ	(AUTO SWEEP)	ATTN 50DB
20.0DBM		VF WIDE
180MHZ/MAX		10 DB/
5MHZ RBW (AUTO)		

Using the Tracking Generator (Option 04 only)

A Tracking Generator (TG) is a powerful tool for measuring the frequency response of a variety of active and passive devices. For examples, see *Spectrum Analyzer Fundamentals*, Tektronix publication 26W-7037-1.

The 2712 built-in tracking generator (Option 04) is an RF sine wave signal source whose output frequency follows, or tracks, the frequency currently being analyzed by the 2712. That is, if the 2712 is currently sweeping from 55 to 300 MHz, the output frequency of the TG also sweeps from 55 to 300 MHz in synchronism with the analyzer. However, it is possible to offset the TG slightly (typically -5 kHz to +60 kHz) with respect to the analyzer frequency to account for circuit drift or signal delays in propagating through the device under test.

The TG amplitude can be varied in 0.1 dB steps from -48 dBm to 0 dBm (or the equivalent in the other reference level units available on the 2712). It is also possible to vary the TG output amplitude over a range of about ± 2 dB relative to its designated amplitude using the front-panel LEVEL control.

The 2712 tracking generator is a powerful tool for all types of swept frequency measurements. You can determine the frequency response of filters, crystals, amplifiers, cables, modulators, and most other 2-port devices. Because the tracking generator is built into the 2712, no other instrumentation is required in many cases. Figure 6-17 shows how simple the setup can be. However, if you are testing a broadband device that does not have a 50 ohm input and output, it may be necessary to insert matching networks between the TG output/device input and the device output/analyzer input. Provision is made in both the Input Menu and the Demod/TG Menu to

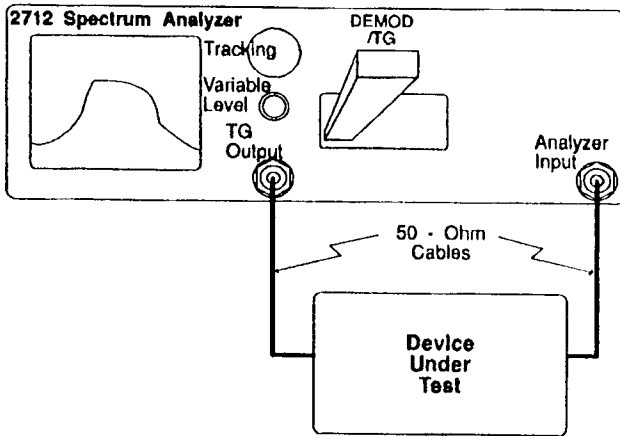

Figure 6-17. Equipment setup for tracking generator measurement of 50-ohm devices.

account for attenuation (or amplification) of external networks. The status of all TG parameters and controls is stored when power to the 2712 is turned off. The condition of the TG will be the same after the power to the 2712 is turned back on that it was before power was turned off. The status of the parameters is also retained when the TG is turned off from the Demod/TG Menu. **To ensure that we all begin this discussion with the same settings, press:**

[UTIL]/[1]/[1]

This recalls the factory default power-up settings, turning off the TG and setting its parameters to their default values.

Turning the Tracking Generator On and Off

Call up the Demod/TG Menu by pressing:

[DEMOD/TG]

Item 4, TRACKING GENERATOR, is a toggle that turns the TG on and off. Its current status is indicated at the end of the line. Press [4] to toggle the TG to ON. The LED above the TG output lights indicating the TG is active and the screen reverts

to the spectral display. At the lower left of the screen the TG output amplitude is displayed (the default is -48.0 dBm) in the current reference level units. Press **[DEMOD/TG]** and toggle item 4 again to turn the TG to **OFF**.

Normalizing the Tracking Generator

The TG is normalized by determining the VCO voltage needed to center its output signal in the 3 kHz resolution BW filter at 100 MHz. Its output amplitude at 100 MHz is then measured by the 2712 and properly adjusted as it is stepped through its entire range.

To ensure maximum accuracy when making TG measurements, the TG must first be normalized. Because TG normalizations depend on the 2712 reference, the analyzer normalizations must be valid to achieve optimum results. See *Normalizing The 2712* and *Service Normalizations* in this section.

To normalize the TG, ensure the analyzer is in spectral display mode and press:

[UTIL]/[3]

Then select item 3, **TRACKING GENERATOR ONLY**, from the Normalizations Menu.

NOTE

The **ALL PARAMETERS** selection from the Normalization Menu refers only to 2712 parameters, not the tracking generator.

Following the on-screen prompt, connect a cable between the TG output and the analyzer input, and press **[W]**. Usually, in about two minutes, a **NORMALIZATION COMPLETE** message will appear on screen. If you receive a **NORMALIZATION FAILED** message, repeat the normalization. If it cannot be completed satisfactorily, contact your Tektronix representative.

If any of the 2712's reference normalizations are missing or faulty, you will receive this message:

**** ONE OR MORE REFERENCE NORMALIZATIONS HAS NOT BEEN PERFORMED.**

**** FOR OPTIMUM ACCURACY, REFERENCE NORMALIZATIONS MUST BE DONE**

**** CONSULT MANUAL FOR PROCEDURE**

PRESS "W" TO CONTINUE

PRESS "Z" TO ABORT

If you have facilities to carry out the reference normalizations (see *Service Normalizations* in this section), abort this process and perform the reference normalizations before continuing. Otherwise, press **[W]** to continue. A recently normalized instrument is more accurate than an unnormalized one, even if the references have not been normalized.

TG normalization is not continuously monitored by the 2712. To avoid inaccuracies due to temperature differentials, long-term drift, or other causes, we recommend that you periodically renormalize the TG during long measurement sessions, or readjust the tracking to keep narrow resolution BW filters properly aligned.

In some 2712s, the peak of the 5 MHz resolution BW filter does not occur precisely at the center of its bandpass. This can result in small amplitude differences when switching from the 5 MHz filter to narrower filters. Relative responses using the 5 MHz filter are unaffected. To determine the amount of error (if any), make a TG measurement using first the 5 MHz and then the 300 kHz filters (the 300 kHz filter is symmetric about its peak response). Note the difference and correct any absolute power measurements that you make with the 5 MHz filter by that amount.

Setting the Tracking Generator Amplitude

In many cases, you will wish to increase the -48 dBm TG output level. For instance, when using the 5 MHz resolution BW filter, a -48 dBm signal is hidden in the analyzer noise floor.

To reset the output amplitude, call up the Demod/TG Menu and select item 5, TG FIXED LEVEL. Following the on-screen prompts, enter a new value of -10.0 dBm, and then press [DEMOD/TG] to return to the spectral display. Notice that the new amplitude value is now shown at the lower left of the screen.

Ensure a cable is connected from the TG output to the analyzer input. Activate the video filter and reset the reference level to 10 dBm.

What is displayed is the combined TG/analyzer frequency response across the 2712's entire input frequency range. You may find the flatness of the response varies slightly as you change the TG output level. This is normal and within specification. However, any variation in flatness can be removed like this:

- Establish the test parameters including center frequency, span, resolution BW, reference level, and TG output.
- Connect the TG output to the analyzer input, and save the resulting sweep in the A register.
- Insert the device to be tested.
- Conduct all measurements in the B,C MINUS A mode. This approach subtracts out the variations in combined TG/analyzer response leaving only the response of the device.

Turn on the A register, and then save the display by pressing [A]/[SAVE ENABLE]/[A]. Call up the Demod/TG Menu again, and this time select item 6, TG VARIABLE LEVEL. This is an ON/OFF toggle that enables you to vary the TG output amplitude from -2 dB to plus several dB relative to the fixed amplitude specified by item 5.

Return to the spectral display by pressing **[DEMOD/TG]**. Notice the indicated TG output level is now followed by an asterisk (*). This indicates that TG variable level is enabled.

Rotate the **2712 LEVEL** control (outer knob) all the way counter-clockwise. The D-register sweep should drop about 2 dB below the sweep saved in register A. Rotate the **LEVEL** control fully clockwise. The D sweep should rise several dB above the A sweep. Note that the indicated TG output amplitude has not changed; the TG output level is not calibrated when **TG VARIABLE LEVEL** is **ON**.

When the variable level control is set above the fixed level, it is possible to slightly compress the TG output signal, which may cause some degradation of the second harmonic specification. This is normally not a problem with passive linear devices, but can result in some intermodulation products with nonlinear components, and spurious radiation from active devices such as modulators or transmitters. To avoid these problems, we suggest that you use the TG fixed level and analyzer reference level controls to move signals vertically on the screen, rather than using the variable level feature.

Now unsave the A register and toggle the **TG VARIABLE LEVEL** to **OFF**.

Adjusting the Tracking

The TG tracking is the amount by which the TG output frequency is offset from the frequency currently being analyzed by the 2712. The tracking can typically be adjusted from -5 kHz to +60 kHz. For most measurements, the tracking is not turned on (tracking = 0 Hz). However, when making measurements with a very narrow resolution BW filter (e.g., the 300 Hz filter), or when the device under test creates a significant delay between its input and output ports (e.g., a long cable), it is necessary to adjust the tracking to ensure the TG signal is centered in the analyzer resolution BW filter.

To see how the tracking adjustment works, first reset the center frequency and span as follows:

Center Frequency	100 MHz
Span	10 kHz/div

The 3 kHz resolution BW is automatically selected, and the display is a single horizontal line at about -10 dBm.

Save the display in register A. Turn on TG tracking by pressing:

[DEMOD/TG]/[7]

and return to the spectral display. It is unchanged except for the message TRKG 0HZ at the lower right of the screen.

Turn the **FREQ/MKRS** knob several clicks in either direction. The indicated tracking should change by about 30 Hz per click, but nothing else happens. **Continue turning the knob until the D-register sweep decreases 6 dB relative to the A sweep. Now turn the knob in the opposite direction until the D sweep again decreases 6 dB.** The indicated tracking should change polarity. What you have done is to offset the TG output to the 6 dB down points of the 3 kHz resolution BW filter.

Select the 300 Hz resolution BW filter. The D sweep may decrease dramatically because the 300 Hz and 3 kHz filters are not always concentric. **Rotate the knob until the D sweep returns to the level of the A sweep.** The TG output is now centered in the 2712's 300 Hz resolution BW filter.

Whenever you make measurements with the 300 Hz filter, always peak the response with the tracking control to ensure you are measuring the maximum signal. It is recommended that you also periodically check the tracking during long measurement sessions when using the 3 kHz filter. Further, whenever you use a 3 kHz or narrower filter to test a device that imposes a significant group delay on the received signal (such as a long cable), vary the tracking to ensure the analyzer is correctly peaked. Because the TG signal is delayed, it lags behind the analyzer frequency by an amount that depends on the analyzer sweep rate and the group delay.

Unsave the A register and select the 3 kHz filter.

Using External Amplification/Attenuation With the TG

It is possible to insert another device such as an impedance matching network, attenuator, or amplifier between the TG output and the device under test. You can account for the gain or attenuation (and impedance change) introduced by the device. The altered output level appears on screen. This feature is a valuable aid whether recording data photographically, with a printer/plotter, or via the GPIB.

Suppose, for instance, that you want to drive the device under test with a +10 dBm signal. You can do this by setting the TG output to -10 dBm and inserting a +20 dB amplifier between the TG and the device under test. In another case, you may wish to drive the TG at full output (0 dBm) but insert an external impedance matching pad to produce a better SWR.

To account for external amplification or attenuation press:

[DEMOD/TG]/[8]/[1]

and enter the appropriate value following the on-screen prompts. The TG EXT ATTEN/AMPL shows the value entered and TG FIXED LEVEL changes to include the offset. Note that entering a non-zero value automatically turns on the amplitude offset feature, while a value of zero automatically turns it off; you can also toggle the offset on and off using **[DEMOD/TG]/[8]/[0]**. Return to the spectral display. The on-screen TG output level has changed to show the offset value and is followed by OFST to indicate the amplitude has been externally altered.

Suppose you wish to use the TG and analyzer with a device that has a 75 ohm input and output, and the desired reference level unit is the dBmV. To carry out a measurement:

- Insert a matching minimum loss pad such as the units supplied with the 2712 into the TG output and the analyzer input.

- Call up the Input Menu and select the dBmV ((INPUT)/(3)/(1)). Notice that the TG output level units as well as the reference units change.
- Again call up the Input Menu and enter -7.5 dB to account for the external attenuation/impedance change of the minimum loss pad on the analyzer input ((INPUT)/(6)/(1) and follow the prompts).
- Call up the Demod/TG Menu and enter -4.0 dB to account for the external attenuation/impedance change of the pad on the TG output ((DEMODO/TG)/(8)/(1) and follow the prompts). The value is different because the impedance change is in the opposite direction. Return to the spectral display. TG output level should indicate 33.0 dBmV.
- To verify your setup, connect the two pads together with a short cable. Set the center frequency to 100 MHz, the span to 1 MHz/div, and turn on a marker. Change the reference level until the sweep is within one division of the top graticule line. The measured amplitude should agree with the indicated TG output to within a few tenths of a dB.
- Set the TG output to the required level, and the analyzer parameters to those desired for the measurement. Re-adjust the reference level as needed to get the sweep to the top of the screen, and then save the sweep in the A register. (For amplifiers it is best to adjust the reference level so the sweep is n dB down from the top to the screen, where n is the amplifier gain.)
- Now connect the output of the pad on the TG to the input of the device under test, and the device output to the input of the pad on the analyzer input. Carry out your measurement in the B,C MINUS A mode.

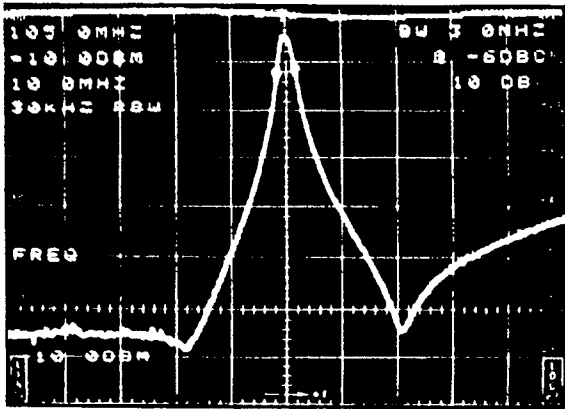

Figure 6-18. Bandpass filter response using the 2712 optional tracking generator and B,C MINUS A mode.

A Practical Example

Figure 6-18 shows the frequency response of a passive bandpass filter near its resonant frequency (105 MHz). To obtain the picture, the TG output was first connected directly to the analyzer input. The sweep at the top of the figure was obtained and saved in the A register. It represents the combined TG - analyzer response over the displayed frequency span. The bandpass filter was then substituted for the device under test in Figure 6-17, and the analyzer placed in B,C MINUS A mode. This approach subtracts the measured instrumentation response (the A sweep) from the combined filter - instrumentation response to obtain the true filter response in the B register. The analyzer was set as indicated by the on-screen readouts. Notice that the bandwidth feature ([APPL]/[0]) is also enabled.

UTIL

The Utility Menu provides access to system configuration and initialization features, front-panel settings and waveform storage facilities, instrument normalization and diagnostics, and miscellaneous other functions. Some of the selections within the Utility Menu and its submenus are used by service personnel to troubleshoot the 2712. Therefore, not all selections are discussed here.

You have already used the Utility Menu to restore the factory default power-up settings to the 2712. Do it again now by pressing:

[UTIL]/[1]/[1]

900.0MHz	(AUTO SWEEP)	ATTN 50DB
20.0DBM		VF WIDE
180MHz/ MAX		10 DB/
5MHz RBW (AUTO)		

Menu-Entered Control Settings

Although the 2712 controls are most conveniently activated or set using the dedicated front-panel controls, the Utility Menu provides a method of setting all the major control functions from a single submenu. This feature is especially useful when you are setting up a new measurement, and know ahead of time how the analyzer is to be configured. In the following example, you are going to use the Utility Menu to reset the center frequency, reference level, and span. You could also set the resolution BW, video filter, vertical scale, and sweep rate.

Turn on the calibrator, and then press [UTIL]/[2] to select the **KEYPAD ENTERED SETTINGS** from the Utility Menu. This item enables you to set instrument controls to specific values from a single menu without having to use the front-panel controls.

Select item **0, FREQUENCY**, from the Keypad Entered Settings Menu. Following the prompt, enter a value of **100.000 MHz** for the center frequency. The Keypad Entered

Settings Menu shows the frequency to three decimal places, whereas the on-screen readout displays the specified frequency from zero to four decimal places depending on the span. Both values are truncated figures, but the 2712 still controls the frequency to the nearest Hertz specified. The number of decimal places in the on-screen readout is commensurate with the screen resolution at the selected span.

You can also enter decimal values for the reference level and span. **Select items 1 and 2 and enter values of -22.28 dBm and 22.6832 MHz/division respectively.** The analyzer rounds and stores the reference level to one decimal place (0.1 dB). The span is rounded and stored to three decimal places, but in the spectral display both the reference level and span are shown rounded to one place.

Leave the remaining parameters set as they are, but note the following:

- RF attenuation can be set to **AUTO** (the default), or fixed from 0 to 50 dB in 2 dB steps.
- The resolution BW can be set to **AUTO** (the default), 300 Hz, 3 kHz, 30 kHz, 300 kHz, or 5 MHz (also 1 kHz, 10 kHz, 100 kHz, and 1 MHz with option 14; or 200 Hz, 9 kHz, and 120 kHz, and 1 MHz with Option 12). If you enter another value, the 2712 will convert it to the nearest available value.
- This menu provides the only method of manually setting the video filter bandwidth. The video filter bandwidth can be set to **AUTO** (in which case it is 1/100 of the resolution BW in normal mode) or fixed from 3 Hz to 300 kHz in a 1-3 sequence (3 Hz, 10 Hz,...100 kHz, 300 kHz). Other values will be converted to the nearest permissible values.
- Selecting item 6, **VERTICAL SCALE**, calls up another menu which enables you to select any of the normal values of 10 dB/division, 5 dB/division, 1 dB/division, or Linear.
- Sweep rate can be set from 1 microsecond/division to 2 second/division in a 1-2-5 sequence. Other values will be converted to the nearest permissible value. Rates faster than 100 microsecond/division can be used only with analog displays (i.e., display storage turned off).

Press **[UTIL]** to return to the spectral display and view the screen you've created.

Return to the Keypad Entered Settings Menu and re-enter a span/div of 20 MHz and a reference level of -20 dBm. Restore the spectral display by pressing **[UTIL]**.

Saving and Recalling Settings and Displays

The 2712 enables you to save and recall up to 36 sets of control settings and any saved displays that accompany them. These are in addition to the factory default power-up settings that are permanently stored in the instrument. The 2712 also automatically saves the settings/displays in use (in location 0) when it is powered down. You can manually save up to 35 additional setting/display groups, and designate one group as the power-up settings.

A general word of caution: the 2712 will not allow you to destroy a currently saved display. If you attempt to recall settings (with or without corresponding displays), you will receive this message:

CANNOT OVERWRITE SAVED DISPLAY

The settings will be recalled along with any displays saved in registers that are not currently saved, but currently saved registers will not be overwritten. To recall a previously saved display, first unsave its destination register.

Recalling Last Power-Down Settings

Turn off the analyzer and then turn it on again. We want to use the same control settings that we were using. Do we have to reset each of them? Not at all!

Call up the Utility Menu and select item 1, STORED SETTINGS/DISPLAYS. Choose item 0, LAST POWER-DOWN, from the secondary menu that appears. The settings that were in effect the last time power to the 2712 was turned off are immediately recalled. Our settings are back again.

100.0MHz	(AUTO SWEEP)	ATTN 10DB
-20.0DBM		VF WIDE
20.0MHz/		10 DB/
5MHz RBW (AUTO)	CALIBRATOR	

User-Defined Power-Up Settings

We've used the preceding **LAST POWER DOWN** parameters for many of our experiments. Now let's make them the power-up parameters.

Call up the Utility Menu and again select item 1, STORED SETTINGS/DISPLAYS. From the secondary menu that appears, select item 2, USER DEFINED POWER-UP. Following the prompt, press [X] to store the current settings. You are warned if other settings are already stored as the user-defined power-up. In that case, delete the old settings by pressing [Y], and then [W] to confirm the deletion. Then store the current settings.

Turn the instrument's power off and back on. During the standby period, the factory default power-up settings are displayed, but immediately afterwards the settings you just stored are automatically implemented.

At power-up the analyzer restores the user-defined power-up settings, if they exist, following the standby period. If they don't exist, it uses the factory default settings. If the user-defined power-up settings include a narrow span, the **NORMALIZATION SUGGESTED** message may appear. The message should disappear following warmup, as soon as you use a control.

Change the measurement parameters (it doesn't matter to what), then re-initialize the 2712 by pressing:

[UTIL MENU]/[0]

This does one of two things. If user-defined power-up settings have been stored, they are implemented. If not, most controls are reset to the factory defaults (but a few are reset to their last power-down condition -- see *Appendix C*).

Other User-Defined Settings

Great! But what about the remaining items on the Stored Settings/Displays Menu? Each one of them can be used exactly as you used **USER DEFINED POWER-UP SETTINGS**. The difference is that they aren't automatically implemented at power-up time, or by the initialization selection; they must be recalled from the Stored Settings/Displays Menu.

Turn on the calibrator, change the frequency to 90 MHz, and the reference level to -10 dBm. Save a 16 sweep ensemble mean in register A, and save the max hold values in B. Turn off the calibrator. Call up the Utility Menu and select **STORED SETTINGS/DISPLAYS. Notice that settings 3-8 are blank², and item 9 indicates **MORE**.**

There are, in fact, 34 fields (in addition to last power-down and user-defined power-up) contained on 4 menu pages in which you can save stored settings and displays. **Advance to page 4 by repeatedly pressing [9]. Backup to the first page by pressing [BKSP] three times.** The register locations currently being displayed are indicated at the top right of each page (R00-R08, R10-R18, R20-R28, R30-R39).

Store the settings you entered earlier in the register 3 location by pressing [3]/[X] (if there is a setting already present, delete it or use another location).

Unsave the A and B registers, and turn them off. (If you do not, you receive the "Cannot Overwrite Saved Display" message when you try to recall settings.) Disable **MAX HOLD.**

² If your instrument has been used previously, you may find that some or all of the items already contain saved settings and displays.

Reinitialize the analyzer to your user-defined power-up settings ([UTIL]/[0]). Now press [UTIL]/[1]. Item 3 reads:

AB 90MHZ -10DBM 20MHZ

This message shows the primary analyzer control settings that are saved in that location and tells you register A and B waveforms are saved along with the settings.

Press [3]/[W]. The control settings and the saved waveforms are both restored. Whenever you save settings (including LAST POWER-DOWN and USER DEFINED POWER-UP), you also store the contents of digital storage registers A, B, and C. This means you can store up to 108 waveforms as well as 36 groups of settings (actual numbers depend on what else, such as user-defined programs, is being stored). Furthermore, this information is saved even after the power is turned off. You can do things like record waveforms in the field and bring them back to the lab with you for further analysis or permanent recording -- or store reference waveforms in the lab for comparison in the field!

You can also store settings and waveforms by title. Using the Display Menu, create a title for the current display (see *Adding Titles and Labels* in this section). Call it MY SETTINGS. Turn on title mode and return to the spectral display. Press:

[UTIL]/[1]/[4]/[X]

This saves the settings under item 4 of the Stored Settings/Displays Menu. Again press [UTIL]/[1]. Item four on the menu is now "MY SETTINGS". The settings are recalled like any other, but the title often helps remind you what the settings are used for.

Any control settings can be used

Normalizing the 2712

What is normalization? Normalization is a set of procedures contained in ROM which calculate gain and frequency characteristics of the circuits in the 2712 based on the built-in 100 MHz, -30 dBm calibration signal. The characteristics must be accurately known to correctly scale and display the analyzed signal, and to control the optional tracking generator. The normalization values are stored in non-volatile memory (NVRAM). Later you will learn how external signals can be used to achieve even greater measurement accuracy -- or to renormalize the reference if NVRAM should ever be lost (see *Service Normalizations* later in this section).

If the 2712 self-test feature detects that the present analyzer gain or frequency characteristics differ significantly from those determined during the previous normalization, it displays:

NORMALIZATION SUGGESTED

in mid-screen. You should then perform a normalization, although the analyzer remains useable for "rough" measurements. The **NORMALIZATION SUGGESTED** message may also appear while the analyzer is warming up, especially if the user-defined power-up settings include a narrow span. This is normal. You need not perform a normalization unless the message persists beyond the warm up period. Any time you require the utmost accuracy, we recommend a normalization first. Normalization may be required because of:

- Circuit or component variation with time (drift)
- Large temperature difference from that at which previous normalization was carried out
- Non-Volatile Memory (NVRAM) is lost for any reason

Always perform the normalizations in environments, especially temperatures, like those in which the subsequent measurements will be carried out. Also remove any input signals from the analyzer before performing amplitude or frequency normalizations. Although we recommend that you wait a full 15 minutes after power-up before making measurements with the 2712 (it's within spec by then), it's possible to make them shortly after power-up. If you must make measurements immediately after the instrument is turned on and the **NORMALIZATION SUGGESTED** message is on screen, then carry out a normalization directly. Note, however, that if you do so, the analyzer may require renormalization after it is fully warmed up.

Call up the Utility Menu and select item 3, NORMALIZATIONS. The Normalizations Menu enables you to normalize the 2712 amplitude parameters (**AMPLITUDE ONLY**), the frequency parameters (**FREQUENCY ONLY**), or both (**ALL PARAMETERS**). It takes longer for amplitude normalization than for frequency normalization, and several minutes for both. Routinely select **ALL PARAMETERS** to ensure the 2712 is measuring amplitude and frequency as accurately as possible, but if you are in a hurry, you can select only the parameters that are more important to your measurements.

NOTE

If Option 04 (Tracking Generator) is installed in the 2712, another choice, **TRACKING GENERATOR ONLY**, is also offered. See *Normalizing the Tracking Generator*. The **ALL PARAMETERS** selection does not normalize the TG.

To continue with the 2712 amplitude and frequency normalization, ensure that all signals are disconnected from the analyzer input. Then select item 0, ALL PARAMETERS.

Typically, you will see a number of changing waveforms and messages on screen telling you which normalizations are being carried out. However, if NVRAM is ever lost, the factory reference normalizations are lost with it (see the *If You Lose NVRAM* in this section). Then, regardless of which

normalizations you are carrying out, you will receive this message:

**** ONE OR MORE REFERENCE NORMALIZATIONS HAS NOT BEEN PERFORMED.**

**** FOR OPTIMUM ACCURACY, REFERENCE NORMALIZATIONS MUST BE DONE**

**** CONSULT MANUAL FOR PROCEDURE**

PRESS "W" TO CONTINUE

PRESS "Z" TO ABORT

If you have facilities to carry out the reference normalizations (see *Service Normalizations* in this section), abort this process and perform the reference normalizations before continuing. Otherwise, press [W] to continue. A recently normalized instrument is more accurate than an unnormalized one, even if the references have not been normalized.

The normalization process executes without further operator intervention. When it is complete, a beep sounds (if the audio alert is enabled -- see *The Audio Alert* later in this section) and this message appears:

NORMALIZATION COMPLETE

If you receive a message that either frequency or amplitude normalization failed, try the procedure again. In case of repeated failures, contact your Tektronix Service Center. The spectral display reappears automatically upon completion of normalization.

System Configuration

Call up the Utility Menu and select item 4, **SYSTEM CONFIGURATION**. The System Configuration Menu presents you with nine choices. Let's look at them in order.

Item 1 specifies the primary address of the 2712 (the 2712 does not support secondary addresses), which can be any value from 0 to 30. When the 2712 is used with a system controller, the value must match that used to configure the controller. The address 0 is usually reserved for the controller itself. When the 2712 is used in the **TALK ONLY** mode with a plotter, any address can be used. The address you set is read immediately by the 2712 and retained in NVRAM until you change it.

Item 2 determines whether the 2712 generates a service request (SRQ) at power up. Because there is normally no need for a SRQ at power up, the default setting of item 2, **POWER ON SRQ**, is **OFF**. However, in some cases you may want to sense that power has been turned on before continuing your test. For those cases you can toggle the **POWER ON SRQ** to **ON** by pressing [2].

Item 3, **EOI/LF MODE**, sets the end-of-message designator. When a message is transmitted over the GPIB, the instrument sending the message signifies to other instruments on the bus (including the system controller) that the message has been completed. This can be done in two ways.

- The interface management line named End Or Identify (EOI) is asserted (brought to its low state) simultaneously with the last data byte that is transmitted.
- The ASCII codes for carriage return (CR) and line feed (LF) are appended to the message. EOI is still asserted simultaneously with the transmission of LF.

All Tektronix instruments and controllers use EOI. You should, therefore, toggle item 3 until the end of the line indicates EOI. The **EOI/LF MODE** option is included for controllers which do not use the EOI signal line. The option selected is retained in NVRAM until you change it.

Item 4, **TALK ONLY MODE**, must be set to **OFF** when the spectrum analyzer is used with a controller, because the controller determines whether the analyzer is talking or listening. If you normally use the analyzer with a controller, set the **TALK ONLY MODE** to **OFF**.

However, to send 2712 screen plot data directly to a GPIB plotter without a controller, set the **TALK ONLY MODE** to **ON**, and disconnect all instruments except the 2712 and the plotter from the bus. Place the plotter in the listen only mode (usually done with controls on the plotter). With the talk only and listen only modes selected, you can send screen data from the 2712 to the plotter by pressing [PLOT].

RS-232 Configuration -- To configure the 2712 for RS-232 operation, select item 2, RS-232, on the COMMUNICATION PORT CONFIG Menu. The RS-232 Port Configuration Menu appears. Several choices are offered; in all cases the 2712 settings must match those used by the controller or printer/plotter.

Item 0, **STATUS**, enables you to toggle the RS-232 port on and off line. The port must be online to communicate with any other device.

Item 1, **BAUD RATE**, cycles through the baud rate of the port. Possible baud rates are:

110	600	4800
150	1200	9600
300	2400	

Normally you set this parameter to as large a value as possible to hasten data transfer. However, the controller, or the printer/plotter, must support data transfers at the same rate. When 110 is chosen, two stop bits are automatically selected; for any other value, 1 stop bit is automatically selected. The default value is 9600.

Item 2, **DATA BITS**, determines the number of data bits per word. The default is 8 bits and is required for binary data transfers. Seven bits can be used for ASCII character transfers.

Item 3, **PARITY**, cycles amongst **NONE**, **ODD**, and **EVEN**. **NONE** is the default.

Item 4, **EOL**, sets the end-of-message designator. When a message is transmitted via RS-232, the instrument sending the

message signifies that the message has been completed. Hardware termination is not possible with RS-232 as it is with GPIB, but item 4 enables you to select **CR** (carriage return), **LF** (linefeed), or **CR LF** (both).

Item 5, **FLOW CONTROL**, specifies the type of handshaking that will be used. Three choices are possible:

HARD (RTS/CTS)

The **RTS**, **CTS**, **DTR** lines are used. The **DCD** and **DSR** lines are ignored. This mode facilitates binary transfers.

SOFT (XON/XOFF)

XON/XOFF (CTRL Q/CTRL S) protocol is used. Only transmit and receive lines are needed, but **RTS** and **DTR** must be forced true. Suitable for use with a modem.

However, code conflicts make binary transfers unreliable.

NONE

No flow control is used, but **RTS** and **DTR** must be forced true. Suitable for use with a modem. However, the user is responsible for ensuring data buffers do not overflow.

Item 6, **ECHO**, is a toggle intended for use with "dumb" terminals. When **ECHO** is **ON**, the 2712 sends the character it has just received back to the terminal causing it to appear on the terminal screen. **CTRL Q** and **CTRL S** are not echoed.

Item 7, **VERBOSE**, is another on/off toggle. When **VERBOSE** is **ON**, a response is returned to the controller following each command or query. The response may be an event code, the correct query response, or a simple "OK" for a completed command not normally requiring a response. When **VERBOSE** is **OFF**, only responses to queries are generated.

Selecting the Screen Plotter Configuration

Whichever communications port is installed in your analyzer, the spectral display and its attendant information can be sent to a printer or plotter by pressing [**PLOT**], but you must first correctly configure the interface.

To configure the port in your analyzer for use with your particular printer or plotter, select item 1 of the System Configuration Menu, **SCREEN PLOT CONFIGURATION**.

Item 0, **COMM PORT**, on the Screen Plot Configuration Menu simply indicates which communications port is installed in your instrument. No operator action is needed. However, your print/plot device must also be equipped with a corresponding interface (GPIB or RS-232).

Item 1, **PLOTTER LANGUAGE**, cycles through the printer and plotter models supported by the 2712. **Repeatedly select item 1 from the menu**. Each time you press [1], the printer or plotter displayed at the end of the line changes. **EPSON FX** (the default) refers to FX-series printers produced by Epson, and **HPGL** stands for Hewlett Packard Graphics Language. **Stop when the model of your printer/plotter (or the one yours emulates) is displayed**.

If you set item 1 to a plotter, plot speed and number of plots per page options appear on the Screen Plot Configuration Menu. **Repeatedly select item 2, PLOT SPEED**, to cycle through the available speeds of **FAST, FASTER, FASTEST, SLOW, and NORMAL** (the default). **Try the various speeds with your plotter to see which produces the most satisfactory results**. Printers do not support these options.

If you select 4 plots per page, a plot position option appears which enables you to select the quadrant of the paper on which the current plot will be placed. **Repeatedly select item 4, PLOT POSITION**, to cycle through the available positions.

Item 5 on the Screen Plot Configuration Menu determines whether or not graticule lines are printed on the hard copy output. Status of the plotted graticule lines is independent of whether the on-screen graticule illumination is on or off. **Press [5] to toggle the GRATICULE LINES ON PLOT between ON and OFF**.

Selecting the Printer Configuration

Certain 2712 features such as **SIGNAL SEARCH** enable you to send ASCII character strings to the analyzer's display CRT or to the optional RS-232 port. You cannot send these strings to a GPIB device.

Return to the System Configuration Menu ([UTIL]/[4]) and select item 2, PRINTER CONFIGURATION. Then select item 0, PRINTER DEVICE.

If the RS-232 interface is installed, the **PRINTER DEVICE** will toggle between **TTY00** and **CRT**. If RS-232 is not installed, **CRT** is always displayed. **Select CRT if you want results that would normally be sent to a printer to be displayed on the 2712 screen instead.** On-screen display is sometimes not satisfactory if there is more than one screen of data, because only the last screen remains visible.

Changes to this setting are not retained in NVRAM.

Instrument Configuration

Item 3, **INSTRUMENT CONFIGURATION**, of the System Configuration Menu enables you to reset 2712 internal parameters and conditions. Some of the more useful ones are described in the following subsections.

The Audio Alert

Item 0, **AUDIO ALERT**, of the Instrument Configuration Menu is a four-step sequencer whose status is indicated at the end of the line. You can choose **OFF**, **KEYCLICK ONLY**, **ERROR ONLY**, or **KEYCLICK & ERROR**.

OFF

The 2712 creates no audible beeps.

KEYCLICK ONLY

The 2712 emits a short beep when a key is pressed.

ERROR ONLY

This is the factory default. A beep occurs only when the

2712 issues an alarm, error, or warning message. The alert sounds only once, even if the condition repeats, but a displayed message is repeated.

KEYCLICK & ERROR

Combination of **KEYCLICK ONLY** and **ERROR ONLY** modes.

Switch the audio alert to the setting of your choice.

Setting the Minimum Signal Size

Minimum signal size is the smallest amplitude difference that must exist between signal peaks for them to be recognized as separate peaks during "Next Higher" and "Next Lower" or Marker arrow operations. It is expressed in bits, full scale being 255 bits. The minimum value is 2 bits; factory default is 20 bits or about 8% of full scale (three minor divisions).

Select item 1, **MINIMUM SIGNAL SIZE**, from the **Instrument Configuration Menu**. Type a new value and enter it by pressing **[W]**. The new value appears at the end of item 1. Experiment if you wish, then restore the factory default value.

Sending Waveforms To a Computer

Item 2 of the Instrument Configuration Menu, **WAVEFORM TO PRINTER** ([UTIL]/[4]/[3]/[2]), sends a binary or ASCII representation of the displayed waveform to the serial port following each sweep. The analyzer must have the RS-232 port (Option 08) installed, and **PRINTER CONFIGURATION** ([UTIL]/[4]/[2]/[0]) must be set to TTY00.

Item 2 toggles data transmission **ON** and **OFF**; item 3 toggles the data format between **ASCII** and **binary**.

This feature is used primarily for certain procedures at the factory; we recommend that you leave WAVEFORM TO PRINTER turned off.

100.0000MHz	(AUTO SWEEP)	ATTN 10DB
-20.0DBM		VF 3KHz
20.0KHz/		10 DB/
3KHz RBW (AUTO)	CALIBRATOR	

Turning Phase Lock On and Off

The 2712 uses internal reference oscillators to analyze the input signal. At wide spans, a slight amount of drift in an internal oscillator is not noticeable. However, as the span is reduced to a few kHz/div or less, any internal oscillator jitter becomes apparent. The on-screen indication is phase noise close to the base of a signal and/or an apparently drifting signal. Therefore, the oscillators in the spectrum analyzer are typically phase locked to a stable reference when operating at narrow spans. This happens automatically in the 2712 when the span is 20 kHz/div or less. Phase lock minimizes the amplitude of the noise pedestal close to a signal, but may actually increase it slightly at frequencies farther away. Therefore, the 2712 enables you to turn off phase lock when desirable.

Toggle phase lock between **AUTO** and **OFF** using item 4, **PHASELOCK**, from the Instrument Configuration Menu. Return to the spectral display to see the effects. Leave **PHASELOCK** in **AUTO** when you are done.

300.0MHz	(AUTO SWEEP)	ATTN 10DB
-20.0DBM		VF WIDE
50.0MHz/		10 DB/
5MHz RBW (AUTO)	CALIBRATOR	

Turning Frequency Corrections On and Off

During normal operation, the 2712 periodically computes frequency corrections (to compensate for short-term drift within the analyzer itself) and applies them to the displayed trace. It does this between sweeps. You can shorten the inter-sweep interval by disabling the frequency corrections, although some

high-frequency accuracy may be sacrificed, and the signal may drift off screen at small spans/div.

NOTE

Short Holdoff mode reduces the inter-sweep interval even further, but also disables most marker measurement modes.

Observe the spectral display for a few sweeps. Can you see the slight pause about every fourth sweep? This is the period during which the corrections are computed and implemented.

Reduce the span to 50.0 kHz/div. Watch the signal peak for several minutes and notice how it drifts relative to screen center and then is recentered as the analyzer computes and implements the corrections.

Item 5, FREQUENCY CORRECTIONS, from the Instrument Configuration Menu is a toggle that enables you to turn the corrections off and on. Press [5] to turn off the corrections, and then return to the spectral display. Notice how the signal now drifts continuously. Reselect item 5 to turn the frequency corrections back on. Return to the spectral display, and note that the signal is again centered.

The Spectral Display In Menus

Press [UTIL]/[4]/[3] to activate the Instrument Configuration Menu. Repeatedly select item 6, SPECTRAL DISPLAY IN MENUS. See how the spectral display is superimposed on the menu? Some people prefer to have the display present when working with menus, others do not. For now, leave the display turned on.

Changing the Sweep Holdoff

There is a holdoff period between the end of one sweep and the start of the next to give the internal circuits in the 2712 time to stabilize. For faster response time when continuous observation of signals is necessary, the delay can be minimized by entering

short holdoff mode. When using short holdoff in AUTO sweep mode, a fictitious signal sometimes appears at the left edge of the screen.

NOTE

Turning on **SHORT HOLDOFF** disables frequency corrections and most marker measurement modes.

Ensure the spectral display is turned on in the menus and select item 7, SWEEP HOLDOFF, from the Instrument Configuration Menu. Messages appear indicating which features are sacrificed when using short holdoff. Read the messages, and then press [W] to continue. The SWEEP HOLDOFF status switches from NORMAL to SHORT HOLDOFF and a signal peak may appear at the left edge of the screen.

Reset the sweep holdoff to NORMAL and turn off the SPECTRAL DISPLAY IN MENUS.

Setting the Date and Time

The 2712 contains a real-time clock with battery backup power. The clock is used to display the date and time and/or to label printer/plotter outputs.

To set the real-time clock, return to the System Configuration Menu ([UTIL]/[4]) and select item 4, **REAL-TIME CLOCK SETUP**. Select items 0 - 5 to update the clock. Terminate each entry by pressing [W]. Select item 6 to toggle the clock display on or off in the menu, the spectral display, and printer/plotter outputs. Press [UTIL] to return to the spectral display.

Protecting Stored Settings

Call up the System Configuration Menu ([UTIL]/[4]). **Toggle item 5, STORED SETTINGS PROTECT, to ensure the end-of-line status indicator is set to ON.**

Press **[BKSP]** to return to the Utility Menu, and select **STORED SETTINGS/DISPLAYS**. Attempt to delete any stored setting. This message appears:

ONLY WAVEFORMS DELETED

When **STORED SETTINGS PROTECT** is turned on, you cannot delete the stored settings, but waveforms stored along with them will be deleted.

Turn **STORED SETTINGS PROTECT** off.

The 2712 File System

The 2712 stores settings, waveforms and other data in a system of files in NVRAM. Normally you will not alter those files.

To view a directory of existing file names, press:

[UTIL]/[4]/[6]

2712 file names are established by the firmware. Table 6-5 lists the file names and describes their contents. Files are created only as required. That is, you won't find a **BSET03** settings file unless you have previously saved the B-register settings in the third storage location.

DSET00 and **SET0BU** are special files. They are created automatically by the 2712 and contain the D-register settings used when the analyzer was last turned off. **SET0BU** is a backup in case **DSET00** is corrupted during a power-down-up cycle.

Other files of a temporary or transitory nature may also be created by the 2712 for internal purposes.

Protecting Files

Files you wish to preserve such as waveform, settings, or UDP files can be protected from accidental erasure in several ways. For instance, UDP files can be selectively protected from the User Def Menu, while all settings files can be protected by pressing **[UTIL]/[4]/[5]**.

However, to selectively protect individual files in the 2712's file system, first determine its file number by viewing the

Table 6-5. The 2712 file system.

Settings files: Each file saves the 2712 control settings for a particular register (A, B, C, D) in a designated location (00-39). **BSET03** saves B-register settings in the number 3 location.

Curve files: Each file saves curve data from register A, B, or C in a designated location (00-39). D-register curves are never saved. **AWFM04** saves the A-register curve in location 4.

User-Definable Program (UDP) files: Each file saves a keystroke sequence representing a particular UDP in a designated location (0-8). **UDP1** is the second user-defined program.

Antenna Table files: Each file saves the antenna table in a designated location (1-5) representing antenna data for a particular antenna. **ACF3** saves the antenna information in location 3.

Normalization file: Normalization files save the data generated by normalizing the 2712, including reference and TG normalizations.

FILE NAMES

Curves	Settings	User-Defined		Normalizations
		Programs	Antenna Tables	
nWFM00	nSET00	UDP0	ACF1	NORM
:	:	:	:	
nWFM39	nSET39	UDP8	ACF5	
n=A,B,C	n=A,B,C,D			

Several other files representing system parameters may also be present:

NAME	DESCRIPTION	NAME	DESCRIPTION
S_RTC	Real-time clock configuration	12.88	Version
SETUP	Instrument configuration	S_GPIB	GPIB configuration
SEARCH	Signal search configuration	S_TTYx	RS-232 configuration
S_PLOT	Plotter configuration		

file directory (**[UTIL]/[4]/[6]**). The number is listed under the FID column in the directory. **Return to the System Configuration Menu and select item 7, PROTECT FILE.** Following the on-screen prompt, enter the number of the file you want to protect. **Confirm your selection by pressing [W].** It is now impossible to delete the file without first unprotecting it.

To unprotect a previously protected file, repeat the foregoing process. The process constitutes a toggle which alternately protects and unprotects the designated file.

A word of caution: unless you have specific reasons for doing otherwise, don't protect system parameter and normalization files (see Table 6-5). Doing so may prevent the 2712 from carrying out its normal functions, or updating data.

Confirming Installed Options

If you are in doubt as to which options are installed in your instrument, press:

[UTIL]/[4]

Item 9 on the resulting System Configuration Menu is labeled **INSTALLED OPTIONS DISPLAY**. Select item 9. The resulting display begins by listing the instrument's firmware version and the Tektronix copywrite. Below that, two columns list the options installed in your analyzer. You will see a readout similar to:

NVM 1 12.88
GPIB
TRACKING GEN

NVM 2 12.88
VIDEO MONITOR

The number following NVM (non-volatile memory) is for internal Tektronix use only and of no value to the user. The list will vary according to the options actually installed in your instrument.

Any control settings can be used.

Instrument Diagnostics and Adjustments

Many of the items on the Instrument Diagnostics and Adjustments Menu are intended for servicing of the 2712. However, we will discuss a few of them you can use to verify instrument performance. Items not discussed are reserved for service personnel or for use under factory supervision.

Call up the Utility Menu and select item 5, INSTR DIAGNOSTICS/ADJUSTMENTS.

Aligning the Display with the Screen

NOTE

This procedure will overwrite saved waveforms without warning!

To align the display, select MANUAL ADJUSTMENTS from the Instr Diagnostics/Adjustments Menu, and then select DISPLAY STORAGE CAL from the resulting Manual Adjustments Menu ([UTIL]/[5]/[2]/[2]).

This selection creates a checkerboard display used to adjust trace position and rotation. The trace rotation, vertical, and horizontal alignment controls are located on the back of the analyzer (see *Miscellaneous Controls* in section 5).

Turn the TRACE ROT control until the checkerboard test pattern is rotationally aligned with the graticule. Adjust the VERT POS control until the the top line of the pattern coincides with the top graticule line. Last, turn the HORIZ POS control until the vertical center line of the display coincides with the center vertical line of the graticule.

After completing the alignment, repeatedly press [UTIL] until the spectral display reappears.

Service Normalizations

The 2712 contains a set of frequency and amplitude normalization values when it is shipped from the factory. The normalizations are based on reference values, called reference normalizations, determined at the time of manufacture. The reference normalizations specify the 2712 gain step sizes and the frequency and amplitude of the internal calibrator signal. The references are determined by comparison with an accurate external attenuator and signal source. If NVRAM is ever lost (for instance, because the battery runs down), the factory reference normalizations are lost with it, and you must perform a service reference normalization to achieve maximum accuracy from the 2712. If you have signal sources available which are more precise than the on-board calibration signal, they can be used to achieve added accuracy when normalizing the analyzer.

Select item **5, SERVICE NORMALIZATIONS**, from the **Instr Diagnostics/Adjustments Menu ([UTIL MENU]/[5]/[5])**. Using the **REFERENCE NORMALIZATIONS** selection from the Service Normalizations Menu, you can measure new reference values for the on-board calibration signal and attenuator with respect to more precisely known alternate sources. The alternate sources must exceed these specifications:

- frequency: $5 \text{ parts in } 10^7 \pm 10 \text{ Hz}$
- amplitude: $-30 \pm 0.1 \text{ dBm @ } 100 \pm 1 \text{ MHz}$
- attenuation (gain step): $10 \pm 0.5 \text{ dB @ } 100 \pm 1 \text{ MHz}$

We won't give examples for all reference normalizations, but we will show you how to determine a new frequency reference.

Connect an external frequency source to the analyzer input meeting the frequency specification given above. Various sources are available: WWV in the U.S., some broadcast television carriers (check with the station), assorted frequency standards, etc. A frequency of 100-500 MHz would be very good, but signals as low as 5 MHz can be used.

Return to the spectral display and perform a center measure to ensure the external reference is centered. Then select item 1, REFERENCE NORMALIZATIONS, from the Service Normalizations Menu. Next select item 1, INTERNAL REF

FREQ, from the resulting Reference Normalizations Menu. On-screen prompts appear for each of the reference normalizations. Select item 1 and enter the frequency of the external source. Now simply select item 2 and press [W] when you are ready to have the analyzer determine the new reference. After a few seconds you'll receive a NORMALIZATION COMPLETE message.

Determining new gain step and amplitude references is done in a similar fashion (follow the prompts).

After you determine the new reference values, complete the process of optimizing the 2712's accuracy by performing a complete normalization ([UTIL MENU]/[3]/[0]).

The remaining items on the Service Normalizations Menu are normally used only by service personnel. However, menu item 4 can be used to view selected normalization values, and item 5 sends the normalization values to a printer. These can be handy for future reference. Item 6 sends any messages that occur during normalization to the printer.

To obtain hard copy of the normalization values, place your Epson FX-compatible printer on-line (sorry, a plotter won't work unless it can emulate an FX-series printer) with the paper in correct position, and select item 5 from the Service Normalizations Menu. Printing starts immediately. Control of the analyzer is returned following printout.

If You Lose NVRAM

The NVRAM in the 2712 is powered by lithium batteries. Battery life is limited to a few years (see Table 2-6).

WARNING

Handling and disposing of lithium cells can be hazardous. Refer all battery maintenance to a Tektronix service center.

When the batteries run down, NVRAM and all of its contents are lost. All stored settings, tables, and waveforms disappear, as well as all normalization data. To prevent inadvertent loss of the reference normalizations, routinely return your analyzer to Tektronix for battery replacement. When a Tektronix service

center replaces your battery, it also re-normalizes the references ensuring that your instrument will operate within its specifications.

If NVRAM is ever lost in the field, you may have to re-normalize the 2712. To begin the process, press [UTIL]/[3]/[1] to carry out a frequency normalization. The analyzer will use default reference values from internal EPROM's or DIP switches. The default values will not result in optimum accuracy, but will enable you to make approximate measurements. More importantly, they will enable you to carry out the reference normalizations required to ensure the 2712 is fully within its specification and operating at maximum accuracy.

Follow the instructions in *Service Normalizations* and the resulting on-screen prompts to perform the service reference normalizations. After the reference normalizations are complete, press [UTIL]/[3]/[0] to complete the frequency and amplitude normalizations.

If external reference sources are not available, simply perform the frequency and amplitude normalizations ([UTIL]/[3]/[0]). The 2712 will be useable, but the references should be renormalized at the earliest opportunity. If the battery is worn out, you will have to renormalize the 2712 each time it is used until the battery can be replaced.

Any control settings can be used.

Generating a Service Request

Utility Menu item 6, SERVICE REQUEST, enables you to manually generate a service request (SRQ) whenever required for testing or other purposes. See the *2712 Programmer's Manual* for detailed information about SRQs and their uses.

To generate a SRQ, simply press [UTIL]/[6]. If communications port is on line, the request is generated immediately and reflected on-screen by the message REQUEST at bottom center (if the port is off line, nothing happens). The message remains on screen until serviced by the controller, or until the communications port is cycled on and off line using [UTIL]/[4]/[0]/[0]/[0] or [UTIL]/[4]/[0]/[2]/[0].

NOTE

The techniques for reporting the event causing an SRQ are different for GPIB and RS-232. See the *2712 Programmer's Manual*.

Printing The On-screen Readouts

The Utility Menu also enables you to print the on-screen readouts on an FX-series printer. The analyzer must be equipped with the optional RS-232 port, and the printer must be connected directly to the port. Each on-screen line is terminated with a linefeed regardless of the terminator selected from the RS-232 configuration menu. Further, the RS-232 port must be on line to use this feature.

Printing the on-screen readouts can be handy if you wish to print results during a user-defined program (UDP) sequence. For instance, suppose that you perform a marker peak find function during the UDP. The frequency and amplitude of the signal are displayed at the upper right of the screen (the normal marker readouts).

To have the 2712 print the readouts via the RS-232 port, ensure your printer is powered up, on line and ready. Place the RS-232 port on line ([UTIL]/[4]/[0]/[2]), and press [UTIL]/[9]/[0]. This selects the PRINT READOUTS option under the MORE heading (item 9) of the Utility Menu. Printing begins immediately.

100.0MHz	(AUTO SWEEP)	ATTN 10DB
-20.0DBM		VF 300KHz
1.0MHz/		10 DB/
300KHz RBW (AUTO)		

The Sweep/Trigger Menu enables you to select the 2712 trigger mode. During normal operation of the analyzer, the sweep generator is free running.

A new sweep begins as soon as possible after the end of the previous sweep (there is a small delay for frequency corrections and end-of-sweep processing). However, when dealing with time domain analysis or pulsed signals, it may be advantageous

SWP/TRIG

to trigger the sweep from some characteristic of the input signal, or from another signal related in a fixed way to the input signal.

The Sweep/Trigger Menu also enables you to specify the sweep rate and enter manual scan mode.

Free Running the Sweep Generator

Call up the Sweep/Trigger Menu by pressing:

[SWP/TRIG]

Choose item **0, FREE RUN**, to place the 2712 sweep generator in the free running, or continuous, mode. This is the default setting, and is usually satisfactory for analyzing continuous signals. It is also a good mode for examining the time domain representation of CW and noise-like signals.

Oscilloscope Trigger Modes

Just as on a conventional oscilloscope, you can choose the input signal, an external signal applied at the back panel of the analyzer, or the AC power line as the trigger source. You do this by selecting **INTERNAL, EXTERNAL, or LINE** trigger from the **SWP/TRIG** Menu.

The **INTERNAL, EXTERNAL, and LINE** trigger modes cause the sweep generator to start a new sweep when the trigger signal amplitude crosses a threshold determined by the setting of the **LEVEL** control (inner knob to the left of **[SWP/TRIG]**). If the analyzer is placed in zero span and linear amplitude mode, the resulting waveforms resemble those that you would see on an oscilloscope (detected signal amplitude vs.time).

Internal triggering requires the signal to be at least one division in amplitude (**LIN** or **LOG** mode), and is most often used for time domain analysis.

The **LEVEL** control adjusts a threshold so that the sweep begins when the amplitude of the input signal crosses the threshold. For instance, you might want to trigger internally on the leading edge of a pulsed signal, such as the output of a CW radio transmitter, a radar or sonar device, or a video modulator.

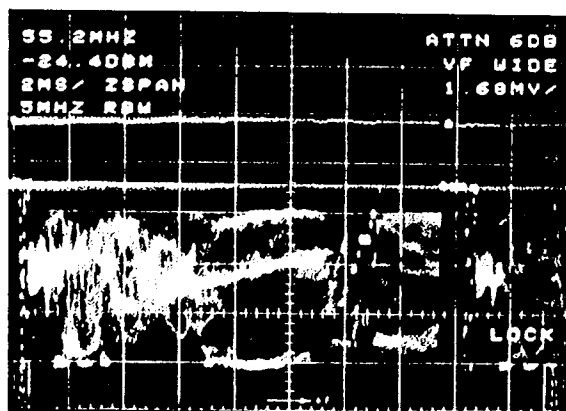

Figure 6-19. Video field using internal or TV field triggering.

If internal triggering is used for spectral analysis, the triggering signal must be tuned to the left edge of the spectral display.

Connect an antenna or cable to the RF input of the analyzer as outlined in *Appendix A*. Tune to a strong television videocarrier and adjust the signal height to near the reference level. Set the analyzer to LIN mode, zero span, and 5 MHz resolution BW. Set the sweep rate to 2 msec/division, and deactivate all storage registers.

You are looking at one field of video information. The dark vertical spaces in the waveform are caused by the time taken to write the on-screen readouts: **turn off the readouts**. The waveform on screen should resemble Figure 6-19, except it will be "sliding" across the screen because the sweep generator is free running.

Select item **1, INTERNAL**, from the Sweep/Trigger Menu, and slowly rotate the **LEVEL** control until the display is stationary. The sweep is now being triggered by the vertical sync pulse.

External triggering is usually chosen for pulsed signal analysis when there is an externally available gate signal signifying that the signal to be examined is present at the analyzer input—for instance, the keying signal from an RF transmitter or the squelch signal in a receiver. (If the gating signal is not

available, you might trigger internally.) The External trigger signal is applied through a BNC connector (J102) on the back of the 2712; its amplitude can be from 100 mV to 50 volts. See section 7 for additional information.

Without changing any other control settings, select item 3, LINE, from the Sweep/Trigger Menu. If the screen goes blank, readjust the LEVEL control. The sweep is triggering on a sample of the AC powerline voltage. The display may be slowly drifting or stationary now. TV sweep rates are nearly harmonically related to line frequency, but small, fractional Hertz differences create the slow drift.

Turn on the readouts.

100.0MHz	(AUTO SWEEP)	ATTN 10DB
-20.0DBM		VF 300KHz
1.0MHz/		10 DB/
300KHz RBW (AUTO)		

TV Line Triggering

Item 4, TV LINE, of the Sweep/Trigger Menu is one of two internal triggering modes that are particularly useful for time-domain analysis of television signals. A horizontal sync pulse begins each TV line. You can designate the TV line standard in use (NTSC, PAL, SECAM, or OPEN) and how the line is selected using item 9, SETUP TABLE. When CONTINUOUS line triggering is selected, any sync pulse will trigger the sweep. KNOB SELECTABLE and KEYPAD ENTRY modes enable you to select a particular horizontal sync pulse as the trigger signal, but these modes are available only if Option 10, the video monitor, is installed. The selected line is displayed at the bottom of the right on-screen readout column. Choosing any HORIZONTAL LINE TRIGGERING mode from the Setup Table also selects TV LINE trigger mode.

To see TV line triggering work, connect an antenna or cable drop to the 2712 as outlined in Appendix A. Change the resolution BW to 5 MHz, and tune to a strong TV video carrier. Ensure the signal peak is close to the reference level.

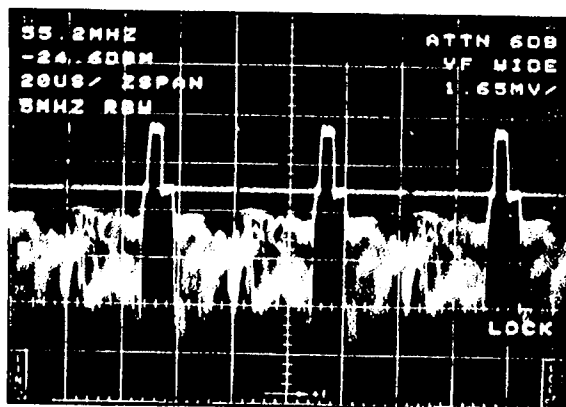

Figure 6-20. Video signal using continuous horizontal line triggering.

Call up the Sweep/Trigger Menu and select **SETUP TABLE**, item 9. Repeatedly select item 4, **TV LINESTANDARD**, until the TV line standard appropriate to your signal appears. Use the **OPEN** (1024 line) setting for non-standard systems.

Items 0 - 3 of the Setup Table determine which sync pulse(s) is used. Choosing any of them also selects item 4, **TV LINE** mode, from the Sweep/Trigger Menu. Select item 0, **CONTINUOUS**, and then return to the spectral display. Turn off digital storage and select zero span. Enter **LIN** mode, and change the sweep rate to 20 $\mu\text{sec}/\text{div}$ (sweep rate is indicated in the left-hand readout column).

The screen should resemble Figure 6-20. In **CONTINUOUS** mode, the sweep generator is triggered by the first pulse that occurs after the analyzer enters the ready-to-be-triggered state. In other words, after the analyzer completes the current sweep, it enters the ready-to-be-triggered state, and is re-triggered by the first horizontal sync pulse that comes along. Thus, a different sync pulse generally triggers each sweep. The video signals following each sync pulse are not quite the same, but are never-the-less displayed on top of each other. The result is an intense, but fuzzy, display.

To use the **KNOB SELECTABLE** and **KEYPAD ENTRY** line trigger modes, the video monitor, Option 10, must be installed.

Call up the Setup Table again and choose item 1, KNOB SELECTABLE. Return to the spectral display. The tuning knob now controls which pulse is used. Pulses are numbered from 6 to 1023. The current line number (horizontal video line number and sync pulse number are the same) is displayed at the bottom of the right on-screen column. If more than one sync pulse is displayed, the number is that of the pulse nearest the left edge of the screen.

Turning the knob clockwise increases the line number and counter-clockwise decreases it. **Turn to about line 17 to view several lines including the vertical interval test signal (VITS).** This signal is usually present between lines 15-20 in the U.S. (see Figure 6-21).

The display is not as bright as it was in **CONTINUOUS** mode, because the analyzer is triggering on, and displaying, only one horizontal line out of every 525. **If the display is too dim, adjust the INTENSITY control.**

When knob-selectable TV line triggering is active, pressing **[MKR/FREQ]/[2]** changes the knob function from frequency control to marker control or video line selection. This is a great convenience if you want to change TV channels. See *Changing the Knob Function* earlier in this section for more information.

Again call up the Setup Table. If you select item 2, KEYPAD ENTERED LINE, the sync pulse indicated at the end of the line will be used as trigger. **Select item 3, KEYPAD ENTRY, and enter number 279 from the numeric keypad.** The number you enter appears at the end of the **KEYPAD ENTERED LINE.** This number also changes when you operate in the knob-selectable mode; it shows the number of the sync pulse last used as trigger. **Press [2] and return to the waveform display.** On most U.S. NTSC stations you now see the VITS for the second picture field.

When using the keypad-entered lines, the tuning knob controls frequency instead of line number.

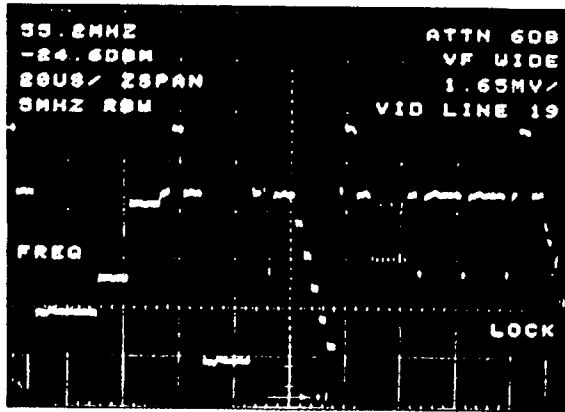

Figure 6-21. Video signal using knob-selectable horizontal line triggering (VITS visible).

TV Video Field Triggering

Item 5, TV FIELD, of the Sweep/Trigger Menu is the second of two internal triggering modes that are particularly useful for time domain analysis of television signals. **Call up the Sweep/Trigger Menu and choose Item 5.** The display is now being triggered by the TV vertical sync pulse which occurs near the beginning of each field. **Using the SWEEP arrow keys, slow the sweep rate to 2 msec/division.** The display resembles Figure 6-19. You can now see an entire frame of video information with the start of frame at the left of the display. The frame does not slip sideways as it does in LINE trigger mode because the sweep generator is locked to the displayed signal itself.

You can eliminate the dark vertical spaces in the display by turning off the readouts.

Setting the Sweep Rate

Now let's slow the sweep rate without using the SWEEP [▲][▼] keys. Call up the Sweep/Trigger Menu and choose **Item 6, SWEEP RATE**. Following the prompt, enter **5 msec/div**. The analyzer reverts immediately to the display mode and you can see three whole video frames. This feature enables you to conveniently set sweep rate when you are already working in the Sweep/Trigger Menu and may have turned off the readouts.

Return to **FREE RUN** mode ([SWP/TRIG]/[0]).

100.0MHz	(AUTO SWEEP)	ATTN 10DB
-20.0DBM		VF 300KHz
1.0MHz/		10 DB/
300KHz RBW (AUTO)		

Manually Scanning

Center a strong video carrier, and then call up the Sweep/Trigger Menu and select **item 7, MANUAL SCAN**.

The spectral display reappears, but it doesn't appear to be updating. Turn the inner **LEVEL** control knob and watch the screen carefully. See a portion of the display update as you turn the knob? In this mode, the **LEVEL** knob controls the horizontal sweep position.

Turn the **LEVEL** control slowly from full counter-clockwise to full clockwise and watch the screen update. This feature enables you to carefully examine a small portion of the spectrum. It is also convenient for manually scanning a broadcast or communications band while listening to demodulated signals -- the 2712 acts like a radio receiver. The operator can stop at any station since he has control of the sweep.

Toggle the manual scan mode off by selecting **item 7** again.

100.0MHz	(AUTO SWEEP)	ATTN 10DB
-20.0DBM		VF WIDE
20MHz/ 5MHz RBW (AUTO)		10 DB/

USER DEF

The User-Definable Menu enables you to store and execute user-definable sequences of keystrokes called routines or programs. The routines are intended to permit a series of operations to be carried out with only two keystrokes. Press [USER DEF] and select the routine you want to run -- the 2712 does the rest! This feature is particularly useful when you have to make a series of repetitious measurements.

Before you can use routines, they must be created, and each routine must have a well-defined starting point. One good way to ensure the routine starts with the correct instrument settings is to begin by recalling a specific group of settings. Another way is to start with a known group of settings, say the factory or user-defined power-ups, and manually change them to the configuration at which your routine begins (this can be done within the routine, but it uses up additional memory).

In the following example, we shall acquire a 20-sweep MAX/MIN ensemble average of the analyzer noise in register A with no calibration signal present, subtract the A register contents from the B register, and display a message cueing us to turn on the calibrator when the average is complete. The result will be the calibrator signal with the average noise subtracted out.

Begin by recalling the factory default power-up settings ([UTIL]/[1]/[1]) and then implementing the settings in the preceding settings box. Store the settings in location 5 ([UTIL]/[1]/[5]/[X]).

To create the user-defined routine:

1. Press **[USER DEF]** and select item **9, USER DEF PROGRAM UTILITIES**. Select item **1, TITLE EDIT** and press **[W]** to begin editing. Enter a title of **TEST01**. The procedure is the same used to title a display (see *Adding Titles and Labels* in this section). The title can be up to 28 characters long. Remember to press **[X]** to store the title. Titling the routine is not mandatory (if you don't supply a title, the routine is named **PROGRAM #** by default) but does help you to recall what a routine is supposed to do.
2. Select item **0, ACQUIRE KEYSTROKES**, from the **USER DEF PROGRAM UTILITIES**. This begins the accumulation of keystrokes. The spectral display reappears with the routine name superimposed and this message:

ACQUIRE KEY STROKES 0 BYTES

Each key that you press will now be recorded in the order in which it was pressed. This sequence of key strokes constitutes the bulk of the user-defined routines. The function of that key is also carried out as you watch. You can return to the **USER DEF PROGRAM UTILITIES** at any time by pressing **[USER DEF]**.

3. Press **[UTIL]/[1]/[5]/[W]** to recall the stored settings.
4. Press **[DSPL]/[1]/[7]/[2]/[0]/[W]**. This sets the ensemble size to 20.
5. Toggle **[8]** until line 8 of the menu reads:

SAVE RESULTS IN DISPLAY A

This places the average in the A register.

6. Press **[6]**. This selects the **MAX/MIN** average.
7. Press **[DSPL]/[USER DEF]/[3]/[W]**. This returns to the **USER DEF PROGRAM UTILITIES** and enters **DISPLAY MESSAGE** edit mode. The message can be up to 32 characters long. The message remains on screen until deleted. Enter the message:

20 MAX/MIN AVG

Remember to press **[X]** to store the message.

8. Press **[USER DEF]/[DSPL]/[1]/[1]** to start the average.
9. After the average is complete, press **[B]/[DSPL]/[2]**.
This turns on the B,C MINUS A in register B.
10. Press **[D]/[A]**. This turns off the A and D registers.
11. Press **[USER DEF]/[3]/[W]/[Y]** to delete the old message.
12. Press **[3]/[W]** to re-enter the **DISPLAY MESSAGE** mode. Enter the message:

WHEN AVG IS DONE

and terminate with **[X]**.

13. Press **[4]** to select **PAUSE FOR "USER DEF" KEY**.
This creates a **PRESS "USER DEF" TO CONTINUE** message on screen when your routine executes and halts the routine until you press **[USER DEF]**.
14. Press **[USER DEF]/[3]/[W]/[Y]** to delete the old message.
15. Press **[USER DEF]/[INPUT]/[9]** to turn on the calibrator.
16. Press **[USER DEF]** and select item 2, **WAIT FOR END OF SWEEP**. This is a message instructing the analyzer to wait for the completion of the current sweep and all end-of-sweep processing before proceeding with further instructions. The analyzer also displays:

WAIT FOR END OF SWEEP

when the routine executes until the processing completes. The delay here guarantees the calibrator time to come on before the succeeding center measure is carried out.

If the display line/limit detector feature is active, it converts the **WAIT FOR END OF SWEEP** message to **WAIT FOR LIMIT**. This halts the execution of the user-defined routine until the alarm condition has been satisfied. You could then use **[SAVE]/[register]** to store the alarming signal, or readout its amplitude using the marker.

17. Press **[CTR MEAS/TRKG]**. This will center and count the calibrator signal.
18. Press **[USER DEF]** and select item 2, **WAIT FOR END OF SWEEP**. Features like Center Measure require the delay this instruction yields to prevent parameters from changing before the count is completed.

19. Press **[USER DEF]/[6]/[3]**. This stores the routine in location 3. You can not store a routine in a location in which another is already stored. You must first delete the prior routine.
20. To prevent your routine from accidental erasure, press **[USER DEF]/[9]** and select item 8, **PROTECT**, and then press **[3]**. Select item 7, **DELETE**, and notice the # next to your routine indicating that it is protected. Press **[3]/[W]**. The message:

REMOVE PROTECTION FIRST

appears. To remove the protection, press **[BKSP]/[8]/[3]**. You can now delete the routine if you wish.

Normally, there is no need to repeat this measurement. Doing it once determines how much the amplitude of the calibration signal is above the average noise coming through the 5 MHz resolution BW filter. However, in the case of other routines it may be desirable to have the routine repeat indefinitely. For instance, you might determine the frequency and amplitude of a series of oscillators. Here is the general approach:

1. Do any titling or message generation.
2. Use a **PAUSE FOR "USER DEF" KEY** command.
When the routine is actually running, you attach the external oscillator and press **[USER DEF]** to continue.
3. Perform a center measure to determine the frequency and amplitude of the oscillator signal.
4. Use a **WAIT FOR END OF SWEEP** command to allow the measurement to be carried out by the 2712.
5. Optionally output the result to a printer.
6. Select item 5, **CONTINUOUS EXECUTION**, from the **USER DEF PROGRAM UTILITIES**. The status indicator at the end of the line will change from **OFF** to **ON**. This causes the routine to repeat indefinitely.
7. Store the routine and optionally protect it.

Before executing any user-defined routine, it is generally good practice to reinitialize the analyzer and clear all registers.

To actually start a routine running, press:

[USER DEF]

and select the number of the routine you want to run. The routine begins to execute immediately.

While the routine is running, its title is displayed beneath the left on-screen readout column. If you elect to include a **DISPLAY MESSAGE** in your routine, it is displayed beneath the title. Error and progress messages are also displayed under the right-hand readouts. You can interrupt any routine by pressing **[USER DEF]** (except when **PRESS "USER DEF" TO CONTINUE** is displayed). A continuously executing routine will continue to run until you press **[USER DEF]**.

SECTION
7

EXTERNAL I/O

SECTION 7

EXTERNAL INPUT AND OUTPUT

Thus far we've largely ignored the back panel of the 2712, but it contains several input/output (I/O) connectors. One or more may not be used on your instrument depending on which options you have installed.

Any control settings can be used.

MAINS POWER

For safety, be sure to use a 3-wire AC power cord and be certain the ground conductor is properly connected. Adjacent to the power receptacle is the mains fuse; its size is marked. If the fuse repeatedly blows, it is likely you have a hardware problem. Contact Tektronix.

TV SIDEBAND ANALYZER INTERFACE -- J101

This jack provides the 2712 first local oscillator signal to the Tektronix 1405 TV Sideband Analyzer. The jack is provided as part of Option 15. The 1405 is designed specifically for testing video modulators, transmitters, and CATV headends. The sideband analyzer provides standard video signals to the input of the modulator, whose output is quickly and accurately measured using the 2712. Simply insert a SMA-to-SMA connecting cable between the LO IN jack on the back of the 1405 and J101 on the back of the 2712. You can also superimpose frequency markers generated by the 1405 on the sweep produced by the 2712. The markers consist of variable width "dips" in the 2712 sweep, and are in addition to the intensified frequency markers internally generated by the 2712. To superimpose the markers, connect the Z AXIS OUT signal

from the 1405 to the external video input of the 2712, pin 1 of accessory connector J103; use pin 2 of J103 for signal ground. Turn the markers on or off with the push-buttons on the 1405 and control their width and depth using the WIDTH and INTEN controls on the 1405 front panel. Consult the *1405 Operators Manual* or *Antenna To Tap...No Loose Ends*, Tektronix publication 26W-7043, for instructions on making measurements with the 1405/271x combination (treat the 2712 as though it is a 2710).

J102 -- EXTERNAL TRIGGER

This BNC input connector is clearly labeled both J102 and EXT TRIG. The shell of the connector is at chassis ground. If you plan to use an external trigger (see **SWP/TRIG** in section 6), this is where the trigger signal is input to the analyzer. The trigger signal must be positive-going and rise above 100 millivolts for at least 0.1 microsecond.



To avoid damaging the 2712, combined AC plus DC trigger signal levels must not exceed 50 volts peak.

An external trigger signal starts a new sweep each time it rises above a threshold established by the setting of the LEVEL control, providing the previous sweep is completed and item 2, EXTERNAL, is selected from the Sweep/Trigger Menu.

A typical external trigger signal might be a +5 volt pulse signifying that a transmitter has been keyed on, or that a receiver has detected a signal which rises above its squelch setting. For instance, to determine the spectrum of a gated CW signal, you could apply the gated CW to the analyzer input while triggering the 2712 externally with the gating signal. The analyzer would then perform a spectral sweep only when the CW signal was present at its input.

To trigger the 2712 externally, connect the external trigger signal to the **EXT TRIG** Jack and select Item 2, **EXTERNAL**, from the Sweep/Trigger Menu. Turn the **LEVEL** control fully counter-clockwise and then rotate it slowly clockwise until a sweep occurs. If the external trigger is pulsing, the analyzer sweep should now remain in synchronism with it (if not, you may have to adjust the **LEVEL** control a bit more).

When you are finished, reselect **FREE RUN** trigger mode.

ACCESSORY CONNECTOR -- J103

The accessory jack, **J103**, is a 9-pin "D" connector, but it is not RS-232 compatible. Instead, it provides an interface for video I/O and the analyzer's sweep gate and sweep ramp signals. Terminations are shown in Figure 7-1, and a discussion of each signal follows.

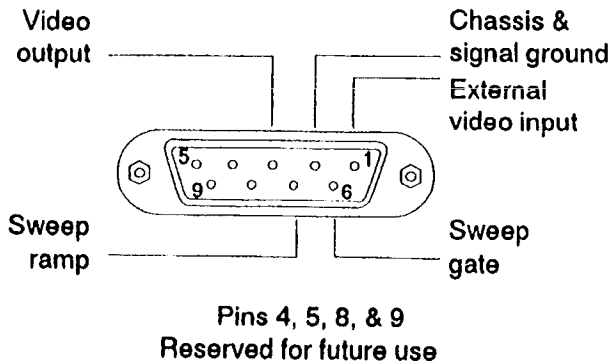

Figure 7-1. Accessory connector (J103).

100.0MHZ	(AUTO SWEEP)	ATTN 10DB
-20.0DBM		VF WIDE
20.0MHZ/		10 DB/
5MHZ RBW (AUTO)	CALIBRATOR	

Pin 1 -- External Video Input

Pin 1 enables you to introduce an external "video" signal to the analyzer, in effect giving it limited oscilloscope capabilities. It is also used to introduce the frequency markers from the 1405 TV Sideband Analyzer (see the discussion of J101).

The "video" signal, in this case, can be any signal limited to a 0-50 kHz band and an amplitude range of 0-1.4 volts. The analyzer preamplifier, RF attenuator, mixer, resolution BW filter, and log amplifier circuits are bypassed; the sweep and vertical scale facilities are utilized.

In addition, the 2712's digital storage remains active. This means you can use the spectrum analyzer to store images of external signals for comparison purposes, or compile statistical estimates of their parameters using ensemble averaging.

To experiment, you need a signal meeting the external input amplitude and frequency limits; various signal generators can be used.

Connect the signal source to pin 1 of the accessory connector and its ground lead to pin 2. Toggle Display Menu item 7, DISPLAY SOURCE, to EXTERNAL.

The analyzer reverts to display mode in zero span (there is no need to sweep the signal past the resolution BW filter since these circuits are bypassed). The top graticule line is 0 volts. The only information in the left on-screen readout that is meaningful is the sweep speed. The sweep speed is initially the speed which was in effect before you switched to EXTERNAL

source, in this case, 50 milliseconds/division. In the right column only the bottom line:

EXT 175MV/

is meaningful, telling you that the external (EXT) input is being used with a vertical scale factor of 175 millivolt/division.

Press [10/5/1] three times and notice that the scale changes to 87.5MV/, 17.5MV/, and back to 175MV/. Turn off all registers to view the analog signal, and then turn the D register back on.

The VERT SCALE and DISPLAY STORAGE function blocks remain operational. You can alter the display scaling, view analog or digital signals, compile ensemble statistics, or select other items from the Display Menu.

Chassis and Signal Ground -- Pin 2

Pin 2 of the accessory connector is chassis and signal ground.

100.0MHZ	(AUTO SWEEP)	ATTN 10DB
-20.0DBM		VF WIDE
20.0MHZ/		10 DB/
5MHZ RBW (AUTO)	CALIBRATOR	

Video Output -- Pin 3

Pin 3 of the accessory connector is the analog video output from the 2712. The analog video output is a 0-1.6 volt signal representing the vertical deflection of the display you see on the analyzer with all registers turned off. 0 volts is the top graticule line and +1.6 volts is the bottom line. The output signal range remains constant regardless of analyzer reference level, attenuation, and vertical scale. The signal can be used to drive an external oscilloscope or other video display unit. For instance, in certain applications a device with a low or high persistence phosphor may be particularly useful.

Connect pin 3 to an input channel of an oscilloscope. At the oscilloscope, select 0.2 volt/division and 50 millisecond/division scale factors; invert the input and trigger internally. You may have trouble triggering because of the multiple signal peaks and blanking period of the video signal, but you should see a spectrum on the oscilloscope similar to the one on the 2712. If not, adjust your oscilloscope trigger and vertical position controls. We'll show you how to overcome this problem in the next paragraph.

Pin 6 -- Sweep Gate

Pin 6 of the accessory connector contains the sweep gate. The sweep gate is a +5 volt pulse whose leading edge is synchronous with the start of the 2712's sweep; the trailing edge marks the end of sweep. See Figure 7-2. The signal is usually used in conjunction with the video output to indicate when a new sweep is beginning.

Continuing with the setup from the Video Output paragraph, connect pin 6 to the external trigger input of your oscilloscope and select the external trigger mode, positive slope. Adjust the oscilloscope trigger level control until the spectral display locks in place. Now turn off all the analyzer's registers. Compare the analyzer and oscilloscope displays.

Do you find the oscilloscope image more or less desirable? This can be especially important when you are trying to view time-varying analog spectra.

Turn on MAX HOLD in register A -- in fact, turn on all the registers. Notice the analog trace is still displayed on the oscilloscope.

By using the video output to view the analog display, all four registers remain available for digital storage and display; you can have an analog display and four (different) digital traces.

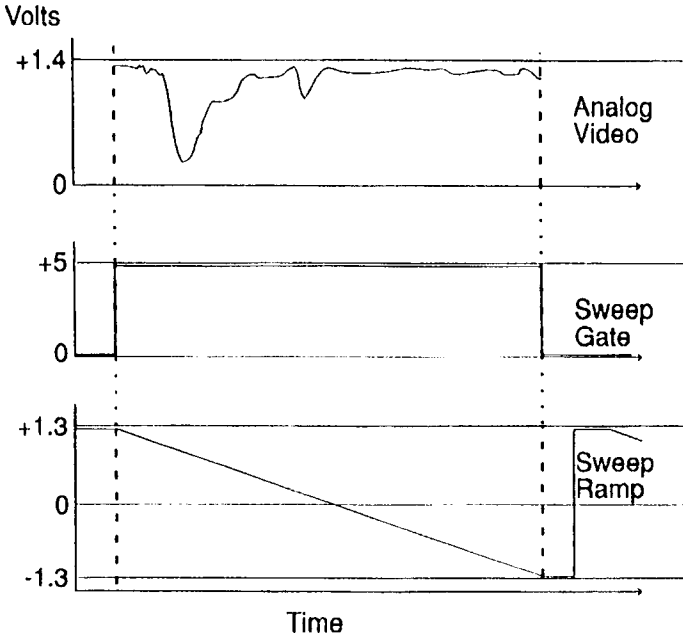

Figure 7-2. Sweep gate and ramp timing.

Does your oscilloscope have a sweep magnifier or delayed sweep facility? Use either to obtain an enhanced view of the central signal peak on the oscilloscope without altering the analyzer settings. The oscilloscope horizontal scale factor equals the 2712 span/division times the ratio of the analyzer and oscilloscope sweep speeds.

Sweep Ramp -- Pin7

Pin 7 of the accessory connector is the sweep ramp. The sweep ramp varies linearly from +1.3 to -1.3 volts, and is proportional to the horizontal position of the sweep as it crosses the screen. The start of the ramp is synchronous with the start of the 2712's sweep; the bottom of the ramp marks the end of sweep. See Figure 7-2. The signal is usually used in conjunction with the video output to generate the horizontal deflection for an external video unit such as an XY oscilloscope or recorder.

Continuing with the setup from the Sweep Gate paragraph, connect pin 7 to the X-axis input of your oscilloscope and the video output to the Y-axis. Place the oscilloscope in XY mode. Adjust the X-axis gain on the oscilloscope until the sweep just fills the screen. If the sweep is backwards, invert the X-axis input (or just use it the way it is).

The advantage in using the ramp to control the oscilloscope is that there is no difference in the time bases used by the 2712 and the oscilloscope. The disadvantage is that you cannot control the oscilloscope time base independently of the analyzer.

J104 -- DIGITAL COMMUNICATIONS PORT

The 2712 is equipped with a digital communications connector labeled J104. The type of connector on your instrument depends on the communications option selected when the analyzer was purchased. If the GPIB port was chosen, J104 is a 24-pin IEEE Standard 488 GPIB connector. If the RS-232 port was chosen, J104 is a 9-pin male "D" connector with terminations conforming to EIA Standard RS-232-C.

The connector pin-outs are shown in Figures 7-3 and 7-4. Signal levels, handshaking, protocols, and other matters of importance to digital communications are detailed in the 2712 *Programmer's Manual* and the pertinent standards.

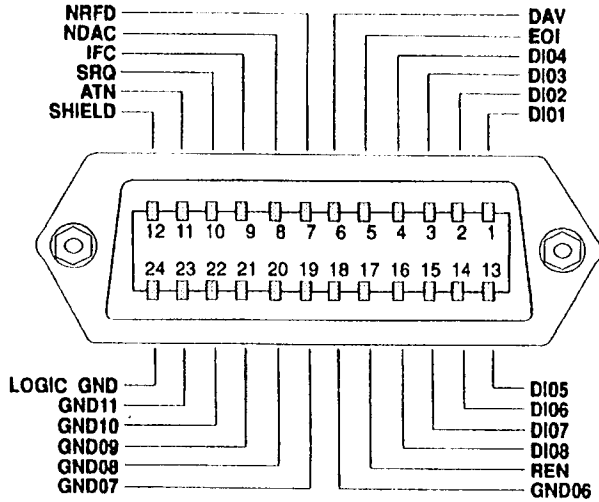

Figure 7-3. IEEE Standard 488 (GPIB) connector pin assignments.

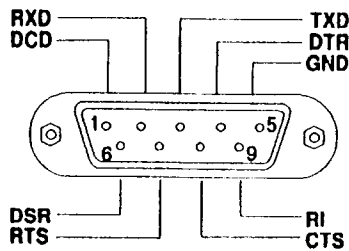

Figure 7-4. EIA Standard RS-232 (C) connector pin assignments.



APPENDICES



APPENDIX A

BROADCAST AM, FM, AND TV SIGNAL SOURCES



Before connecting signal sources to the 2712, be certain the total signal strength is less than +20 dBm. If in doubt, check with a broadband RF wattmeter or voltmeter.

For some of the experiments in this manual, you need AM or FM modulated signals. The most readily available signals are AM and FM broadcasts. To receive AM or FM broadcast radio stations, you can plug a piece of wire directly into the center terminal of the input signal connector on the 2712 and hang the other end out a nearby window. If your building is not metal framed, you can probably dead end the wire in the same room as the analyzer. The required length of wire will depend on the strength, location, and frequency of the transmitter among other variables. 50 kW FM stations 40 miles distant have been received with a wire paperclip, straightened and inserted directly into the input connector -- the 2712 is very sensitive!

TV stations and FM broadcasts can also be received on a standard television antenna or other suitable RF antenna. Before connecting any wire or antenna to the analyzer, ensure there is no static charge on it by momentarily grounding it to the input connector shell. If you are uncertain, use a voltmeter to confirm there are no high-level signals superimposed on the antenna system (such as from a nearby, high-power broadcasting station). Maximum total input to the 2712 must not exceed +20 dBm.

If cable TV is available in your facility, it provides an ideal source of FM and TV signals. Using appropriate connectors, you can plug the cable directly into the analyzer.

APPENDIX B

SYSTEM MESSAGES

The 2712 will display messages when;

- Self-check routines built into the 2712 detect abnormalities
- Incorrect information is entered
- An improper operation is attempted
- It is necessary to alert you to an operation in progress

The messages which you may encounter are contained in the following list; their causes and corrections are indicated immediately below the message. If you are unable to correct an abnormal situation, contact your local Tektronix Service Center and report the message.

1ST MEASUREMENT COMPLETE

Go to the next step in the procedure.

300HZ FILTER NOT INSTALLED

2712 cannot detect presence of 300 Hz filter.

ADDITIONAL NVRAM NOT INSTALLED

Occurs when accessing a file located in extended NVRAM if the 2712 cannot detect the presence of the extended NVRAM.

AMPL NORM SUGGESTED (VR PIN DAC)

Perform amplitude normalization. Consult service center if message persists.

AMPL OUT OF RANGE (NORMALIZATIONS)

Perform amplitude normalization again. If message persists, consult service center.

AMPLITUDE NORMALIZATION FAILED

Perform amplitude normalization again. If message persists, consult service center.

AMPLITUDE OUT OF CALIBRATION

The analyzer amplitude may be out of calibration. This message may be generated by the auto sweep rate measurement routine.

AVERAGE NOISE TOO LOW

The average noise level in the Carrier-to-Noise or Noise Normalization measurement is below the bottom of the screen and cannot be digitized. To correct the problem, reduce the reference level to bring the noise level onto the screen.

AVERAGE IN PROCESS

An ensemble average (not CONTINUOUS) is in process. Used to report event over GPIB.

CALIBRATOR DOESN'T MATCH READOUT

The calibrator is enabled and an external attenuation or external frequency offset is enabled.

CAN'T COUNT WITH CORRECTIONS OFF

Turn Frequency Corrections ON. The location of this selection is [UTIL] / [4] / [3].

CANNOT CALC. VERT. SENSITIVITY

Perform amplitude normalization. Consult service center if message persists.

CANNOT COUNT (VCO IF)

Perform frequency normalization. If message persists, consult service center. Either the VCO counter input or the IF counter input failure can cause this error to occur.

CANNOT COUNT BEAT FREQUENCY

Perform frequency normalization. If message persists, consult service center.

CANNOT DELETE FILE WHILE IN USE

Occurs when attempting to delete a file that is in use.

CANNOT NORMALIZE PLL VCO

Perform frequency normalization. Consult service center if message persists.

CANNOT OVERWRITE SAVED DISPLAY

Old data must be deleted or transferred to STORED SETTINGS before new data can be saved.

CANNOT OVERWRITE STORED WAVEFORM

A waveform is already stored in this register. Old waveform(s) must be deleted first.

CANNOT OVERWRITE STORED SETTING

An instrument setting is already stored in this register. Old setting must be deleted first.

CANNOT STORE - NV MEMORY FULL

Must delete other settings if further storage is desired.

CNTR SIGNAL OUT OF IF PASSBAND

The signal in zero span is not above the threshold. Perform CTR MEAS again or use a wider resolution bandwidth filter. Performing a frequency normalization may also facilitate a count. Because of span and display storage inaccuracies, the signal may not be exactly centered in the digital display.

COMM PORT NOT INSTALLED

2712 cannot detect the presence of the communications port.

COMMAND NOT IMPLEMENTED

Feature not installed on this instrument.

COUNTER FREQUENCY UNSTABLE

Perform normalizations again. If message continues to repeat, consult service center. Frequency counter or input to it is unreliable.

COUNTER NOT INSTALLED

2712 cannot detect the presence of the counter.

DATA ERROR IN FILE

Firmware/Hardware error. Consult service center if message continues to repeat.

DBUV/M MEASUREMENT MODE IDLE

Destination waveform for DBUV/M is not being displayed and the correction calculation is disabled. The mode can be restarted by turning on the destination waveform register.

DEFAULT DATA LOADED

Since a file could not be read to load a data structure, the default values were loaded into the file and into the data structure.

DELETE EDITING BUFFER FIRST

The editing buffer must be deleted before the desired function or entry can be accomplished.

DELETE EXISTING PROGRAM FIRST

A user defined program already exists in this register. It must be deleted before the new one can be stored.

DELETE EXISTING TABLE FIRST

Attempt was made to store an antenna correction factor table in a file position which is already used. You must delete the file via the table deletion menu prior to attempting to store of the new file.

DESTINATION WAVEFORM CONFLICT

Attempt was made to enable two functions that use the same destination waveform. The display line, ensemble average, min hold, dB μ V/M and waterfall mode use destination waveforms.

DIRECTORY ERROR IN FILE

Firmware/Hardware error. Consult service center if message continues to repeat.

DISCONNECT INPUT SIGNAL

Input signal needs to be removed in following step.

DISPLAY LINE OFF SCREEN

The display line is out of range either at the top or bottom of the CRT display.

EMC MODE MUST BE ACTIVE

Attempt was made to use a function dependant upon EMC mode (for instance, QUASI-PEAK) without first activating EMC mode.

EDITING BUFFER IS EMPTY

The local editing buffer for either the UDP or antenna tables is empty. Select Acquire Keystrokes in the User Def Program Utilities menu to begin acquisition. Select Begin Edit in the Edit Antenna Table menu to begin acquisition. If deletion of the editing buffer is being attempted, the error message is simply to inform the user that the selected action is invalid.

END OF FILE

Firmware/Hardware error. Consult service center if message continues to repeat.

ENSEMBLE AVERAGE COMPLETE

Signifies completion of an ensemble average process.

ERROR

Firmware error. Consult service center if message persists.

EXITING QUASI-PEAK DETECTOR

The user has invoked a change in the resolution BW, causing the instrument to exit QUASI-PEAK mode and return to the previous detection mode. This message is displayed when exiting EMC mode. Exiting EMC mode turns off QP because EMC is required for proper functioning of QP.

FATAL ERROR IN FILE

Firmware/Hardware error. Consult service center if message continues to repeat.

FILE NOT FOUND

Occurs when attempting to access a file that does not exist.

FILE SIZE ERROR

Occurs when attempting to create a new file in NVRAM and the size of the new file is not the same as the size of the existing file. The most probable cause is that there is a version mismatch between the file system and the current firmware.

FILE SYSTEM DIRECTORY FULL

Occurs when attempting to store a file in the NVRAM and there are no more directory entries available.

FILE SYSTEM FULL

Occurs when attempting to store a file in the NVRAM there is no more room to store the file.

FIRST STEP MUST BE DONE FIRST

Preceding step must be performed prior to selected one. Part of the reference normalizations are order-dependent.

FORMATTING PLOT

Downloading plot file to hardcopy device.

FREQ OUT OF RANGE (NORMALIZATIONS)

Perform frequency normalization again. If message persists, consult service center.

FREQ NORM SUGGESTED (1ST LO)

Perform frequency normalization. If message persists, consult service center.

FREQ NORM SUGGESTED (FIND SIDE)

Perform frequency normalization. If message persists, consult service center.

FREQ NORM SUGGESTED (INNER PLL)

Perform frequency normalization. If message persists, consult service center.

FREQ NORM SUGGESTED (SET BEAT)

Perform frequency normalization. If message persists, consult service center.

FREQ NORM SUGGESTED (SET VCO)

Perform frequency normalization. If message persists, consult service center.

FREQ NORM SUGGESTED (SPAN DAC)

Perform frequency normalization. If message persists, consult service center.

FREQUENCY NORMALIZATION FAILED

Perform frequency normalization again. If message persists, consult service center.

FUNC NOT AVAIL IN DBUV/M MODE

Selected function is not available with the dBuV/m measurement mode enabled. Functions not available include LIN vertical mode, FM and EXTERNAL display sources, and attempting to unsave the selected destination waveform. Choose new reference units to enable the selected operation.

FUNC NOT AVAIL IN CURRENT MODE

Consult manual for proper instrument settings. This error message may appear, for instance, upon the invocation of instrument functions such as carrier to noise, noise normalized bandwidth, and

antenna correction factors while in linear scaling mode. In these particular cases the vertical scaling mode would have to be changed to logarithmic before invoking the functions. Another case would be the invocation of a user-defined routine while in the user defined routine acquisition mode. The acquisition mode must be exited before any routine can be activated.

FUNCTION NOT AVAIL. IN LIN MODE

Switch to LOG mode vertical scale to obtain proper functioning.

This error message may appear upon the invocation of instrument functions such as carrier to noise, noise normalized bandwidth, and antenna correction factors.

FUNCTION NOT AVAIL IN MAX SPAN

Signal track mode incompatible with MAX SPAN. Try smaller span.

ILLEGAL COMMAND

Firmware error. Consult service center if message persists.

ILLEGAL PARAMETER PASSED (NEW)

ILLEGAL PARAMETER ENTERED (OLD)

Firmware error. Consult service center if message persists.

ILLEGAL START/STOP/INC VALUES

Illegal Start, Stop, or Increment values are present for the antenna correction factor table the user is attempting to edit. Either the initial non-usable values are present (the user has not attempted to enter his own values) or the values entered have some inconsistency such as the start value being greater than the stop value.

INACTIVE MARKER OFF SCREEN

The frequency value of the inactive marker has been retained. The marker itself is not visible being out of the range of the display.

INSUFFICIENT MEMORY AVAILABLE

Not enough memory (NVRAM) is available for the operation.

INTERNAL REF AMPL TOO INACCURATE

Perform reference amplitude normalization again checking for the presence of the correct external reference frequency and amplitude. If message persists, consult service center.

INTERNAL REF FREQ TOO INACCURATE

Perform reference frequency normalization again checking for the presence of the correct external reference frequency and its correct entry from the keypad. If message persists, consult service center.

INTERRUPT FAULT AT FF

Firmware/Hardware error. Consult service center if message persists.

INTERRUPT FAULT

Firmware/Hardware error. Consult service center if message persists.

INVALID DEVICE NUMBER

Firmware/Hardware error. Consult service center if message continues to repeat.

INVALID FILE NUMBER

Firmware/Hardware error. Consult service center if message continues to repeat.

LAST PWR DOWN REG CHECKSUM ERR

Last power down settings bad. Defaults used. Consult service center if problem recurs.

MALLOC: RAN OUT OF MEMORY

Memory allocation firmware/hardware error. Consult service center if message persists.

MARKERS ARE OFF

Marker(s) must be turned on to obtain desired function.

MARKER WOULD OVERWRITE NOISE VALUE

Enabling the marker would overwrite the saved Carrier-to-Noise or Normalized Noise value. Markers cannot be placed on a display saved with Carrier-to-Noise or Noise Norm'd modes enabled.

MUST BE IN DELTA MARKER MODE

Turn on Delta Markers to obtain desired function.

NO LISTENER

A screen plot front-panel operation was attempted to the GPIB port but no listen addressed devices were available. Place a listen-addressed device on the bus and reselect the operation.

NO MODULATION ON SIGNAL

Occurs in zero span when CTR MEAS is attempted and there is no constant frequency modulation on the carrier.

NO SIGNAL (NORMALIZATIONS)

Perform normalizations again. If message persists, consult service center.

NO SIGNAL FOUND ABOVE THRESHOLD

There is no displayed signal exceeding the marker threshold value. Threshold can be reset using the MKR/FREQ Menu.

NO SIGNAL AT CENTER OF DISPLAY

Firmware/Hardware error. Consult service center if message continues to repeat.

NO SIGNAL AT COUNTER INPUT

Perform normalizations again. If message continues to repeat, consult service center.

NOISE LEVEL LESS THAN 2DB

Measured system noise level is less than 2dB above the 2712 noise floor. Noise power correction has been made by NOISE NORM'D or C/N mode algorithms in the 2712.

NON-COMPATIBLE NVM FORMAT

The firmware version was not compatible with the non-volatile memory. Consequently the NVM was re-initialized. Consult service center if message continues to repeat.

NONE OF THE TRACES ARE ACTIVE

A digitized waveform must be on to employ desired function.

NORMALIZATION COMPLETE

Normalization routine successfully finished.

NORMALIZATION SUGGESTED

Frequency normalization needed. If message persists, consult service center.

NORMALIZED RESULT OUT OF RANGE

Perform normalizations again. If message persists, consult service center.

NORMALIZING

Normalization routine running.

NOT AVAILABLE WITH DBUV/M IDLE.

The selected function is not available with DBUV/M mode idled.
Select new reference unit to enable operation.

NOT AVAIL IN SHORT HOLDOFF MODE

Certain functions that require end of sweep processing are not available when in the 'Short Holdoff' mode.

NOT AVAIL IN WATERFALL MODE

The selected function is not available in waterfall mode.

NOT AVAIL W/ DISPLAY STORAGE ON

Function not compatible with digital display. Use analog display.

NOT INSTALLED

Feature not installed on this instrument.

NVM CHECKSUM ERROR

Non-Volatile Memory has been corrupted and consequently re-initialized. Consult service center if message continues to repeat.

NVM FRAGMENTATION ERR

Firmware/Hardware error. Consult service center if message persists.

NVM SEGMENTATION ERROR

Firmware/Hardware error. Consult service center if message persists.

NVM VERSION MIS-MATCH

Firmware/Hardware error. Consult service center if message continues to repeat.

ONLY WAVEFORMS DELETED

When settings you are attempting to delete are protected, only the saved waveforms are deleted.

ONLY WAVEFORMS SAVED

When saving settings in a location containing previously protected settings, only the waveforms are saved.

OUT OF RANGE

A value has been entered that is outside the permitted range. The instrument will default to the closest permissible value. If the message appears at times other than data entry a firmware/hardware error is probable. Consult the service center if message persists.

PLOT ABORTED

New plot request has caused currently running plot to be aborted.
New plot must be requested again in order to restart plot process and obtain new plot.

'PLOT COMPLETE

A plot operation has been finished.

PLOT IN PROCESS

Signifies (for GPIB reporting) that a plot is in progress.

POLYNOMIAL HAS NO SOLUTION

Firmware/Hardware error. Consult service center if message continues to repeat.

PORT OFFLINE

Select **ONLINE** in proper port configuration submenu.

PRINTER ERROR

Check the printer. Some printers return Printer Error for all conditions which need attention (offline, out of paper, etc.); consult the printer manual.

PRINTER IS NOT CONNECTED

Connect printer to appropriate port. Check printer cable.

PRINTER OUT OF PAPER

Reload printer paper.

PROGRAM NOT EXECUTABLE

The selected user-defined program is corrupted or too big to fit into available internal memory. Delete and resave the affected program.

PROTECTED FILE

Occurs when attempting to delete a file that is protected.

QP (EMC) FILTERS NOT INSTALLED

2712 cannot detect presence of optional EMC filters.

QUERY NOT AVAILABLE

Query attempted on function for which there is no query response.

REAL TIME CLOCK HW FAILURE

Firmware/Hardware error. Consult service center if message persists.

REAL TIME CLOCK NOT INSTALLED

2712 cannot detect presence of real-time clock.

REFERENCE LEVEL HAS NEW RANGE LIMITS

The reference level range limits have changed because the preamp, external atten/ampl, or EMC mode is activated. The reference level itself does not change.

REFERENCE NORMALIZATION FAILED

Perform the reference normalization again checking for the presence of the correct external reference frequency and its correct entry from the keypad if required. If message persists, consult service center.

REGISTER VALUE NOT ALLOWED

A storage register value was utilized which is not legal for the requested function. For example, the register value 1 was used with the GPIB command **STORe**. This attempts to store settings in the factory default power-up register, a reserved register.

REMOVE PROTECTION FIRST

The selected user-defined program cannot be deleted until its file protection is removed.

RUNTASK: CANNOT START PROCESS

Firmware error. Consult service center if message persists.

SATELLITE VIDEO MNTR NOT INSTLD

2712 cannot sense presence of optional satellite (FM) video detector.

SEARCH TERMINATED, MAX SIGNALS

Signal search is terminated if it detects more than 50 signals.

SELECT TALK ONLY MODE FIRST

Screen plot front-panel operation requires the GPIB address mode to be talk only when the plot port is set to GPIB.

SELECTED PROGRAM IS EMPTY

The selected user defined program is empty. No action is taken.

SELECTED STORED SETTING IS EMPTY

Setting must be stored before it can be recalled.

SELECTED TABLE IS EMPTY

The selected antenna correction factor table is empty.

SETTING CORRUPTED

Requested stored setting has been deleted because of a corrupted data value. Consult service center if message persists. This message may also occur in general instrument operation if Settings Verify of [UTIL] / [5] / [4] is turned ON. This selection checks all data transactions involving the instrument settings. No deletions occur in the general operation.

SHORT HOLDOFF MODE NOT INSTLD

2712 cannot detect presence of Short Holdoff feature.

SIGNAL CANNOT BE SET PROPERLY

Perform normalizations again. If message continues to repeat, consult service center.

SIGNAL OUT OF IF PASSBAND

Frequency to be counted is not within one resolution bandwidth of the center frequency. Repeat CTR MEAS or use a wider resolution bandwidth filter. Performing a frequency normalization may also facilitate a count. Because of span and display storage inaccuracies the signal may not be exactly centered in the digital display.

SIGNAL OVER RANGE

The signal peak is above the top of the CRT display. Lower the reference level.

SINGLE SWEEP ARMED

Instrument armed for single sweep.

SINGLE SWEEP MODE

Instrument in single sweep mode.

SINGLE SWEEP TRIGGER

Single sweep has been triggered.

SIGNAL SEARCH COMPLETE

Firmware routine finished.

SIGNAL SEARCH IN PROCESS

Firmware routine running.

STAND BY

Required delay in use of instrument until message disappears.

START FREQUENCY CHANGED

Change in stop frequency necessitated a change in start frequency.

STOP FREQUENCY CHANGED

Change in start frequency necessitated a change in stop frequency.

STORAGE REGISTER EMPTY

No data yet stored in the register accessed.

TABLE CURRENTLY IN USE

The table is currently in use but the user may still delete it if he wishes.

TABLE IS TOO LARGE TO EDIT

The current combination of start/stop/increment setup frequencies results in a correction table with too many elements.

TG NORM SUGGESTED

Tracking Generator normalization is needed for optimum accuracy. If message persists after normalization, contact service center.

TIMER INTERRUPT FAULT

Firmware/Hardware error. Consult service center if message persists. Possible malfunction of interrupt timer on processor board indicated.

TOO MANY FILES OPEN

Firmware/Hardware error. Consult service center if message continues to repeat. Indicates that the maximum number of files is already open. Cannot open any more files at this time.

TRACKING GENERATOR NOT INSTALLED

2712 cannot detect presence of optional tracking generator.

UNCAL

Indicates the 2712 is operating in an uncalibrated state. Occurs if:

- a. Sweep speed is too fast for a specified resolution BW, video filter, and span combination.
- b. QP mode is active and:
 1. the video filter BW < 3 times resolution BW
 2. the center frequency is not appropriate to the selected EMC filter BW (i.e., $10 \text{ kHz} < CF < 150 \text{ kHz}$ for 200 Hz filter, $150 \text{ kHz} < CF < 30 \text{ MHz}$ for 9 kHz filter, $30 \text{ MHz} < CF < 1 \text{ GHz}$ for 120 kHz filter).
- c. One or more critical normalizations have not been completed successfully.

UNCAL OFF

A change-of-state indicator displayed briefly when an uncalibrated state has been corrected and exited.

UNCAL ON

A change-of-state indicator displayed briefly when an uncalibrated state has been entered.

UNDEFINED ERROR CODE

Firmware/Hardware error. Consult service center if message persists. Returned error code has overrun established limits.

UNDEFINED EVENT CODE

Firmware/Hardware error. Consult service center if message persists. Returned error code has overrun established limits.

USE ANTENNA SETUP MENU FIRST

The antenna start/stop/increment frequencies must be set prior to editing the correction table.

USER DEFINED PROGRAM IN PROCESS

A UDP is in progress. Reported primarily for GPIB purposes.

USER DEFINED PROGRAM COMPLETE

A UDP has finished.

USER REQUEST

A user request SRQ has been initiated.

VERT MODE/SCALE MISMATCH ON DIFF

B minus A function attempted with mixed vertical modes (LOG/LIN display, AM/FM demodulator) or mixed scales (10/5/1 dB/, 10/5/1 KHz/, 17.5/87.5/175 MV/). Reset the vertical modes or scales to be consistent. Amplitude mode/scale choices are found in [UTIL] / [2] / [6] with scale choices also available from the front panel VERT SCALE function block. Demodulator choices are found in [DEMOD/TG] / [1] and [DEMOD/TG] / [2].

VIDEO MONITOR NOT INSTALLED

2712 cannot detect presence of optional video monitor.

WAIT ABORTED SWEEP NOT ARMED

Requested WAIT FOR END OF SWEEP was aborted immediately to avoid an endless wait loop. This error occurs if WAIT is requested while in single sweep mode with the sweep not armed.

WARNING: USING EMPTY ANT TABLE

The table called for is empty. The function is still being performed but with values of zero for each increment of the table.

ZERO SPAN ENTERED

Instrument is now in zero span.

APPENDIX C

2712 GLOBAL RESETS

Settings on the 2712 Spectrum analyzer can be reset in many ways. Some of instrument settings are always reset, while others are never reset, and still others are reset during certain reset cycles only. This appendix includes a description of which settings are in each category, and when each category of settings is reset.

DEFINITIONS

These definitions are included to make the following explanations more clear:

Reset -- To restore a setting to a previous state. This is what happens to the Center Frequency, for example, when power is removed and re-applied: The Center Frequency setting is RESET.

Reset Category -- Each setting belongs to one RESET CATEGORY, such as Center Frequency belongs to the "fragile" reset category. The categories are described later in this appendix.

Reset Cycle -- an operation which causes one of the reset categories to be operated upon.

Retain -- The opposite of RESET. A setting is RETAINED for a particular RESET CYCLE if its value can be set to any allowable value and remains at that value after the RESET CYCLE completes.

RESET CYCLE DESCRIPTION

Following is a list of all the reset cycles possible in the 2712:

Power Down/Up Cycle

This cycle is invoked by powering the instrument down and back up again.

Initialize Instrument Settings Cycle

This cycle is invoked via [UTIL]/[0].

Recall Last Power Down Cycle

This cycle is invoked via [UTIL]/[1]/[0].

Recall Factory Default Power-Up Cycle

This cycle is invoked via [UTIL]/[1]/[1].

Recall User Defined Power-Up Cycle

This cycle is invoked via [UTIL]/[1]/[2]/[W].

Recall Numbered Settings Cycle

This cycle is invoked via [UTIL]/[1]/[xx]/[W]. xx is one of a selection of stored settings designated by numerals 0-9 on 4 successive screens.

Power-Up Diag And Reboot Cycle

This cycle is invoked via [UTIL]/[5]/[0]/[9].

RESET CATEGORIES

There are several distinct settings categories in the 2712:

Precious Settings

Precious settings are not reset by any reset cycle. The settings in this class can only be changed by manually setting each to its desired value. Settings in this category include:

Saved Waveforms, Plot Configuration (including Comm Port, Plot Language, and Plot Speed), GPIB or RS-232 configuration, Real-Time Clock configuration, Audio Alert setting, Settings Protect Mode, and Signal Search Parameters.

Mode-related Settings

These are settings which are reset during some cycles and retained for others. The settings are reset as follows:

During an INITIALIZE INSTRUMENT SETTINGS cycle, reset to the values retained at the last physical power down.

During a POWER DOWN/UP cycle, reset to the values retained at the last physical power down, unless a User-Defined Power-up exists. In that case, reset to those stores in the User-Defined Power-up setting.

During a POWER-UP DIAG AND REBOOT cycle, reset the same as during a POWER DOWN/UP cycle, but instead of the values resetting to those retained at the last physical power down, they reset as if a physical power down had just occurred. During all other cycles, do not reset.

The mode-related settings include:

Utility Menu Items

Spectral Display in Menus

Marker/Freq Menu Items

Frequency Reference Mode (CENTER/START), Counter Resolution, Frequency Tuning Mode (AUTO and TABULAR only, others revert to AUTO), Entered Frequency Tuning Increment, Tabular Tuning Table, Frequency Offset, Frequency Offset Mode (ON/OFF)

Input Menu Items

Input Impedance, Reference Level Units, External Gain/Attenuation, External Gain/Attenuation Mode (ON/OFF), dBuV/M Measurement Distance, dBuV/M Antenna Table, dBuV/M Target Waveform

Sweep/Trigger Menu Items

Video Sync Polarity, Video Line Triggering Mode (CONTINUOUS/KNOB/ENTERED), Video Line Triggering Standard (NTSC/SECAM/PAL/OPEN)

Display Menu Items

Ensemble Averaging Destination Waveform, MIN HOLD destination waveform, Ensemble Averaging Mode, Ensemble Averaging Number-of-sweeps, B,C Minus A Offset Mode, Display Acquisition Mode (PEAK/MAX-MIN), Display Line Value

Applications Menu Items

Bandwidth Display dBc Value, Occupied BW percent, Carrier-to-noise Reference Bandwidth, Normalized Noise Reference Bandwidth

Demod/TG Menu Items

Video Monitor Mode (BROADCAST/SATELLITE), Video Monitor Sync Polarity, Video Monitor Video Polarity, all tracking generator functions

Fragile Settings

Fragile settings are those which are reset during ANY reset cycle. Any settings not covered by the previous categories are FRAGILE. Resets occur as follows:

- During POWER DOWN/UP, INITIALIZE INSTRUMENT SETTINGS, and POWER-UP DIAG AND REBOOT cycles, reset to user-defined power-up (if it exists). Otherwise, reset to default values.
- During RECALL LAST POWER DOWN cycle, reset to last power-down settings.
- During RECALL FACTORY DEFAULT POWER-UP, reset to the factory default settings.
- During RECALL USER DEFINED POWER-UP and RECALL NUMBERED SETTINGS cycles, reset to the specified settings storage register.

Normalization values

The normalization values are modified by executing some or all of the instrument's normalizations. These values are only lost in the case of certain NVRAM failures. The values being used by the instrument may be set to default values via the service menus. The actual (most recently passed) normalization values are always restored during the POWER DOWN/UP and the POWER-UP DIAG AND REBOOT cycles. The other cycles do not affect the normalization values.

APPENDIX D

ACCESSORIES AND OPTIONS

ACCESSORIES

The 2712 Spectrum Analyzer is shipped with the accessories listed in Table D-1. Additional optional accessories are listed in Table D-3. Optional AC mains power cords are also available meeting various international standards (see Table D-2).

Table D-1. Standard accessories.

Item	Tektronix P/N
User's Manual	070-8137- XX
U.S. Power Cord (optional power cords are shown in Table D-2)	161-0104-00
Front Cover	200-2520-00
Adapter, 50ohm N Male to BNC Female	103-0045-00
2711 & 2712 Programmer Manual	070-8132- XX

Table D-2. Optional power cords.

Option	Item	Tektronix P/N
A1	Universal Euro, 220 V/50 Hz at 16A	161-0104-06
A2	United Kingdom, 240 V/50 Hz at 13A	161-0104-07
A3	Australian, 240 V/50 Hz, at 10A	161-0104-05
A4	North American, 240 V/60 Hz, at 12A	161-0134-00
A5	Swiss, 250 V/50 Hz, at 6A	161-0167-00

Table D-3. Optional accessories.

Item	Tektronix P/N
Coaxial cable, 50ohm BNC to BNC, 18 in	012-0076-00
Coaxial cable, 50ohm BNC to BNC, 42 in	012-0057-01
Coaxial cable, 75ohm BNC to BNC, 42 in	012-0074-00
Rain Cover	016-0848-00
Accessory Pouch	016-0677-03
Viewing Hood	016-0566-00
Carrying Strap	346-0199-00
Service Kit	606-0110-02
CRT Light Filter (clear)	337-2775-01
CRT Light Filter (gray)	337-2775-02
Camera C-5C, Option 02	C-5C, Opt.2
K212 Portable Instrument Cart	K212
Service Manual	070-8130-01
Transit Case	016-0792-02
Minimum Loss Attenuator, 50ohm N-type Male to 75ohm BNC Female	131-4199-00

OPTIONS

This section describes the features of the options available for the 2712 Spectrum Analyzer and listed in Table D-3 above. Options are usually factory installed, but field kits are available in some cases. Contact your local Tektronix Field Office or representative for additional information.

Option M1-Option M3 (Extended Service and Warranty Options)

There are three extended service and warranty options offered for the spectrum analyzer that go beyond the basic one-year coverage. Contact your local Tektronix Field Office or representative for details.

Option M1: Two routine calibrations to published specifications in years two and three, respectively, of warranty coverage, plus two years remedial service.

Option M2: Four years remedial service.

Option M3: Four routine calibrations to published specifications in years two, three, four, and five, respectively of product ownership, plus four years of remedial service.

(Tracking Generator) Option 04

Option 04¹ adds an internal Tracking Generator (TG) to the Spectrum Analyzer package. The Tracking Generator produces a variable amplitude sinusoidal signal. The frequency of the TG signal closely matches, or tracks, the frequency window of the Spectrum Analyzer. The TG is used most often to measure the frequency response of two-port devices.

See the *Using The Tracking Generator* in section 6 of this manual for operating instructions.

(Low cost inverter/battery pack) Option 07

Option 07 supplies a Tektronix 2704 DC-to-AC Inverter, 2705 Battery Pack, Instruction Manual, and necessary mounting hardware. This option allows operation of the Spectrum Analyzer in locations where AC power is not available. The 2705 provides approximately one hour operation when used with the 2704 Inverter and 2712 Spectrum Analyzer. Operating time can be extended by using additional 2705 Battery Packs, or alternate 12VDC sources. The Inverter also contains a charger and an auxiliary 18 VDC output to power external devices such as Low Noise Block Down Converters (LNB) used in satellite downlink applications.

(RS-232 communications port) Option 08

Option 08 substitutes an RS-232 serial communications port for the standard GPIB port. The serial port conforms closely to the IEEE P1174.232 Draft Standard which defines the features and functions of the RS-232 interface as it applies to instrument systems. However, it does not necessarily comply with the three-level protocol presently proposed. The port is activated and configured via the UTIL Menu. The DB-9 port connector is located on the rear panel of the 2712.

For programming instructions, see your *2712 Programmer's Manual*. Connector terminations may be found in the *Programmer's Manual* or in the *External Input and Output* section of this manual. To configure the RS-232 port, see *System Configuration* in section 6 of this manual.

¹ Options 04, 12, and 14 are mutually exclusive.

Option 10 (Video monitor)

Option 10 provides raster-scan video monitor capabilities. The video signal must conform to a recognized standard (NTSC, PAL, or SECAM). The monitor will not descramble suppressed sync or otherwise scrambled signals. See *Video Demodulation* in section 6.

Option 12² (Quasi-peak/EMC filters)

Option 12 provides a quasi-peak detector in addition to the normal peak detector, and redistributes the 2712 gain to create increased "headroom" for pulse-like signals. This option also provides 1 MHz, 120 kHz, 9 kHz, and 1 kHz resolution BW filters, and modifies the standard 300 Hz filter for 200 Hz operation. With these capabilities, you can make prequalifying EMI/EMC measurements. See *Making EMC Measurements* and *Quasi-peak Measurements* in section 6.

Option 14³ (Additional resolution BW filters)

Option 14 provides 1 MHz, 100 kHz, 10 kHz, and 1 kHz resolution BW filters that "fill in" between the standard selections, enhancing the flexibility and measurement capability of the overall instrument.

Option 15 (TV Sideband Analyzer interface)

Option 15 provides an interface for the Tektronix 1405 TV Sideband Analyzer. The 1st L.O. is buffered, routed to J101 on the 2712 rear panel, and terminated in 50 Ω . The 2712/1405 combination enables you to quickly and conveniently measure TV modulator/transmitter frequency responses.

² Options 04, 12, and 14 are mutually exclusive.

³ Options 04, 12, and 14 are mutually exclusive.

(RF antennas) **Option 20**

This option supplies calibrated antennas for making radiated RF and leakage measurements. The option includes:

- biconical antenna
- log periodic antenna
- non-metallic tripod
- 10 meter cable with connectors

(rackmount adapter) **Option 30**

Option 30 provides the hardware for installing the 2712 Spectrum Analyzer in a standard 19-inch rack. The rackmount adapter requires minimum vertical space of 5.25 inches (an alternate cradle-mount adapter is also available -- see Option 34). The Spectrum Analyzer meets all electrical and environmental specifications when it is mounted according to the procedures accompanying Option 30.

(Travel Line) **Option 33**

Option 33 provides a Travel Line package including a rain cover, accessory pouch, gray CRT filter, and carrying strap.

(Cradle type rackmount adapter) **Option 34**

Option 34 consists of a front panel mask and rack mounted cradle which adapts the 2712 to a standard 19 inch rack. The adapter requires 7 inches vertical rack space. Installation instructions accompany Option 34.

This option preserves the portability of the analyzer. Slide assemblies are provided for front access to, and easy removal of, the analyzer.

INDEX

- | | | | |
|-----------------------------------|-----------|-----------------------------|-----------|
| [10/5/1], | 4-10,5-15 | [AUTO], RES BW, | 4-13,5-13 |
| 2712, | 1-6 | [AUTO], SWEEP, | 4-13,5-18 |
| 75 ohm source, | 6-8 | | |
| A | | | |
| [A], [B], [C], [D], | 5-21 | | |
| <i>About The 2712,</i> | 1-6 | | |
| <i>AC Power Source,</i> | x | | |
| accessories, | D-1 | | |
| accessory connector, | 7-3 | | |
| <i>Accommodating a 75</i> | | | |
| <i>Ohm Source,</i> | 6-8 | | |
| <i>Accommodating External</i> | | | |
| <i>Amplification/Attenuation,</i> | 6-7 | | |
| ACQUIRE KEY STROKES, | 6-122 | | |
| activating registers, | 5-21 | | |
| <i>Adjusting the Tracking,</i> | 6-82 | | |
| <i>Aligning the Display,</i> | 6-109 | | |
| alignment, trace, | 5-38 | | |
| AM DEMODULATOR, | 6-74 | | |
| AM VOL, | 4-11 | | |
| AM/FM signal source, | A-1 | | |
| amplification/attenuation, | | | |
| external, | 6-7 | | |
| amplitude normalization, | 6-94 | | |
| amplitude related | | | |
| characteristics, | 2-5 | | |
| amplitude scale, | 5-15 | | |
| amplitude, tracking generator, | 6-81 | | |
| antenna correction factors, | 6-19 | | |
| antenna table, | 6-19 | | |
| antennas, | A-1 | | |
| Applications (APPL) Menu, | 4-22,6-51 | | |
| arrow keys, | 3-10,4-13 | | |
| AUDIO ALERT, | 6-101 | | |
| | | B | |
| | | back panel, | 4-14 |
| | | backspace key (BKSP), | 4-8,6-4 |
| | | bandwidth, occupied, | 6-59 |
| | | baud rate, RS-232, | 6-98 |
| | | bold italics, | 1-4 |
| | | bold type, | 1-3 |
| | | box, settings, | 1-2 |
| | | brackets, square, | 1-3 |
| | | brightness, | 5-37 |
| | | BROADCAST (AM) VIDEO, | 6-74 |
| | | built-in calibrator, | 3-12 |
| | | C | |
| | | cable TV signal, | A-1 |
| | | calibrator, | 3-12 |
| | | CAUTION, | ix |
| | | center measure, | 5-31 |
| | | changing frequency, | 3-19 |
| | | changing parameters, | 6-2 |
| | | <i>Changing Reference</i> | |
| | | <i>Level Units,</i> | 6-7 |
| | | chassis/signal ground, | 7-5 |
| | | checkout, | 3-4 |
| | | CISPR, | 6-66 |
| | | comm port, configuring, | 6-96 |
| | | communications connector, | 7-8 |
| | | <i>Configuring the</i> | |
| | | <i>Communications Port,</i> | 6-96 |
| | | connector, accessory, | 7-3 |
| | | connector, communications, | 7-8 |
| | | connectors, | 4-3,4-14 |

- contrast-enhancing filter, 5-37
- Control Panel Basics**, 3-10
- control
- frequency, 5-5
 - marker, 5-28
 - reference level, 5-7
 - register, 5-21
 - resolution BW, 5-10
 - span per division, 5-2
 - sweep rate, 5-16
 - vertical scale, 5-15
- controlling readouts, 5-37
- controls
- dedicated, 5-1
 - fundamental, 4-6,5-1
 - overview, 4-3
 - software, 6-1
- conventions, typographical, 1-3
- cooling, xii,3-2
- corrections, frequency, 6-103
- [CTR-MEAS/TRKG], 5-31
- D**
- DANGER**, ix
- data bits, RS-232, 6-98
- data readout, 3-9
- date and time, 6-105
- DBUV/M, 6-13
- DC Power Source**, x
- decibel - voltage values, 6-17
- dedicated controls, 5-1
- default settings, 3-7
- delta (D) marker mode, 5-28
- demodulation, video, 6-74
- Demodulator/Tracking Generator
- (DEMOD/TG) Menu, 4-24,6-72
- deviation, frequency, 6-71
- Diagnostics and Adjustments**, 6-109
- directory, file, 6-106
- Display (DSPL) Menu, 4-26,6-34
- display brightness, 5-37
- DISPLAY MESSAGE**, 6-122
- display register control, 4-9
- display screen, description, 4-1
- display storage, 4-9,5-21
- display storage function block, 4-9
- display, aligning, 6-109
- display, max/min, 3-9
- display, waterfall, 5-25
- dot key (.), 4-8
- E**
- EDITING BUFFER**, 6-19
- Electrical Characteristics**, 2-1
- electromagnetic environment, 6-63
- EMC filter, 6-65
- EMC MODE**, 6-63
- EMI/EMC measurements, 6-63
- emissions, 6-63
- Enhanced Versatility**, 5-10
- Environmental Specifications**, 2-13
- error messages, B-1
- exit, menu, 6-4
- external video signal, 7-4
- external amplification/
- attenuation, 6-7
- external input/output (I/O), 7-1
- external pad, 6-11
- external trigger, 6-114,7-2
- F**
- factory default settings, 3-7
- feature status indicator, 6-2
- field strength, 6-13

- | | | | |
|--------------------------------|--------------|--------------------------------|----------|
| file directory, | 6-106 | | |
| file names, | 6-107 | | |
| file system, | 6-106 | | |
| files, protecting, | 6-106 | | |
| filter, EMC, | 6-65 | | |
| finding signal peaks, | 5-35 | | |
| [FINE], | 4-7 | | |
| first local oscillator, | 7-1 | | |
| first measurement, | 3-13 | | |
| first mixer input, | 6-11 | | |
| FM DEMODULATOR, | 6-73 | | |
| FM DEVIATION MODE, | 6-70 | | |
| FM VOL, | 4-11 | | |
| font, | 1-3 | | |
| fragile settings, | C-4 | | |
| FREE RUN, | 6-114 | | |
| FREQ, | 4-6 | | |
| FREQ/MKRS, | 4-4,5-5,5-28 | | |
| FREQ/MKRS knob, | 3-19,5-5 | | |
| frequency accuracy, | 5-32 | | |
| frequency control, | 3-19,5-5 | | |
| frequency corrections, | 6-103 | | |
| frequency deviation, | 6-70 | | |
| frequency domain, | 1-5 | | |
| frequency normalization, | 6-94 | | |
| frequency related | | | |
| characteristics, | 2-2 | | |
| frequency response (sample), | 6-86 | | |
| frequency, start/stop, | 6-22 | | |
| frequency/marker | function | | |
| block, | 4-4 | | |
| function blocks, | 3-10 | | |
| function keys, | 3-10 | | |
| function status indicators, | 3-10 | | |
| fundamental analyzer controls, | 4-6 | | |
| fundamental controls, | 5-1 | | |
| fuse, | xii | | |
| | | G | |
| | | gate, sweep, | 7-6 |
| | | general characteristics, | 2-9 |
| | | generator, tracking, | 6-77 |
| | | <i>Getting Acquainted With</i> | |
| | | <i>Your Instrument,</i> | 3-1 |
| | | global resets, | 2712,C-1 |
| | | <i> GPIB Configuration,</i> | 6-96 |
| | | ground, ext signal/chassis, | 7-5 |
| | | grounding, | x |
| | | H | |
| | | holding maximum values, | 5-27 |
| | | holdoff, sweep, | 6-104 |
| | | HORIZ POS, | 5-38 |
| | | horizontal sweep position, | 5-20 |
| | | I | |
| | | immediate entry mode, | 3-16 |
| | | immediate frequency | entry |
| | | mode, | 5-7 |
| | | immediate reference | level |
| | | entry mode, | 5-9 |
| | | immediate span/div entry mode, | 5-3 |
| | | impedance matching pad, | 6-11 |
| | | impedance, source, | 6-8 |
| | | inclement weather, | ix |
| | | increasing sensitivity, | 6-21 |
| | | inital checkout, | 3-4 |
| | | <i>Initial Normalization,</i> | 3-6 |
| | | Input (INPUT) Menu, | 4-28,6-4 |
| | | input power, | xi |
| | | input, video, | 7-4 |
| | | input/output (I/O) connectors, | 7-1 |
| | | input/output signal | |
| | | characteristics, | 2-7 |

- Installation,** 3-2
- installed options, 6-108
- instantaneous frequency deviation, 6-70
- Instrument Configuration,** 6-101
- Instrument Diagnostics and Adjustments,** 6-109
- INTENSITY,** 4-11,5-37
- interface, sideband analyzer, 7-1
- internal trigger, 6-114
- Introduction,** 1-1
- J**
- J101 -- TV Sideband Analyzer**
- Interface,** 7-1
- J102 -- External Trigger,** 7-2
- J103 -- Accessory Connector,** 7-3
- J104 -- Digital Communications Port,** 7-8
- K**
- K-factors, 6-19
- keypad, 4-8
- KEYPAD ENTERED SETTINGS,** 6-87
- keys, terminator, 6-4
- knob function, changing, 6-24
- knob, **FREQ/MKRS,** 3-19,5-5
- L**
- Last Power-Down Settings,** 6-89
- [**LIN**], linear scale, 4-10,5-16
- line trigger, 6-114
- Listening to AM Transmissions,** 6-73
- Listening to FM Transmissions,** 6-73
- LOG/LIN scale,** 5-16
- M**
- mains power, x,7-1
- Making Your First Measurement,** 3-13
- MANUAL SCAN,** 6-120
- manual scan, 1-5
- marker control, 5-28
- marker functions, 4-5
- marker readouts, 5-28
- marker, next higher/lower peak, 6-26
- Marker/Frequency (MKR/FREQ) Menu,** 4-20,6-22
- markings, equipment, ix
- [**MAX HOLD A & B**], 5-27
- [**MAX**], **SPAN,** 5-4
- max/min display, 3-9
- maximum signal levels, xi
- maximum span, 4-7
- maximum values, retaining, 5-27
- Measuring Occupied Bandwidths (OBW),** 6-59
- menu display mode, 4-2
- menu keys, 3-10
- menu
- APPL,** 4-22,6-51
- DEMOD/TG,** 4-24,6-72
- DSPL,** 4-26,6-34
- INPUT,** 4-28,6-5
- MKR/FREQ,** 4-20,6-22
- SWP/TRIG,** 6-113
- USER DEF,** 4-25,6-121
- UTIL,** 4-16,6-87
- Menu-Entered Control Settings,** 6-87
- menus, 4-3,6-1
- menus, selecting, 6-1
- messages, B-1
- microvolt per meter, 6-13
- minimum loss pad, 6-11

- | | | | |
|------------------------------------|--------------|-------------------------------------|-----------|
| Minimum Signal Size, | 6-102 | DEF" KEY, | 6-123 |
| mixer input, | 6-11 | [PEAK FIND], | 4-5,5-35 |
| [MKR/D/OFF], | 5-28 | phase lock, | 6-103 |
| MKR/FREQ, | 6-22 | physical characteristics, | 2-14 |
| mode-related settings, | C-2 | [PLOT], | 4-10 |
| mounting, rack, | 3-2 | plotter configuration, | 6-99 |
| | | plotting/printing waveforms, | 5-35 |
| N | | [POWER], | 4-11 |
| noise averaging filter, | 5-13 | power requirements, | 2-8 |
| noise floor, | 3-8 | power, mains, | 7-1 |
| noise power difference, | 5-12 | power, turning on, | 3-5 |
| normalization, | 3-6 | power-up, | 3-5 |
| NORMALIZATION | | precautions, | xii,3-3 |
| SUGGESTED, | 3-6,6-93 | precious settings, | C-2 |
| normalization values, | C-4 | PRESS "USER DEF" | |
| normalizations, reference, | 6-111 | TO CONTINUE, | 6-123 |
| normalizations, service, | 6-110 | primary controls, | 3-14 |
| Normalizing, | | printer configuration, | 6-101 |
| 2712, | 6-93 | <i>Printing On-screen Readouts,</i> | 6-113 |
| Tracking Generator, | 6-79 | <i>Product Grounding,</i> | x |
| NOTE, | 1-8,3-3,3-16 | <i>Protecting Files,</i> | 6-106 |
| numeric keys (0 - 9), | 4-8 | <i>Protecting Stored Settings,</i> | 6-105 |
| NVRAM, if lost, | 6-111 | | |
| | | Q | |
| O | | quasi-peak, | 6-64 |
| occupied bandwidths, | 6-59 | <i>Quasi-Peak Measurements</i> | |
| on-screen readouts, | 4-2 | (<i>Option 12 only</i>), | 6-66 |
| printing, | 6-113 | | |
| operation summary, | 4-1 | R | |
| optional equipment, | 2-10 | rack mounting, | 3-2 |
| options, | D-1 | ramp, sweep, | 7-7 |
| options, installed, | 6-108 | [READOUT], | 4-10,5-37 |
| <i>Oscilloscope Trigger Modes,</i> | 6-114 | readouts, on-screen, | 3-9 |
| output, video, | 7-5 | real-time clock, | 6-105 |
| | | recalling settings, | 6-89 |
| P | | <i>Receiving And Unpacking,</i> | 3-1 |
| parameters, changing, | 6-2 | [REF LEVEL], | 4-6,5-7 |
| PAUSE FOR "USER | | [REF LVL STEP], | 4-7,5-9 |

- reference level, 3-14
reference level control, 5-7
Reference Level Units Menu, 6-3
reference level units, setting, 6-7
reference normalizations, 6-111
register control, 5-21
register status indicators, 3-10
Repackaging And Storing, 3-1
repeating UDPs, 6-124
RES BW, 5-10
RES BW arrow keys, 4-13
RES BW function block, 4-12
RES BW, [AUTO], 4-13
resets, 2712,C-1
resolution bandwidth, 1-5,3-18
resolution BW control, 4-12,5-10
resolve, 1-5
resolving signals, 5-11
Restoring the Factory Default Settings, 3-7
RF attenuation, controllong, 6-6
RF INPUT, 4-13
RS-232 Configuration, 6-98
- S**
- safety, ix
sans serif, 1-3
SATELLITE (FM) VIDEO, 6-74
[SAVE ENABLE], 5-23
saving data, 5-23
scan, manual, 1-5
scanning manually, 6-120
screen alignment, 5-38
Screen Plotter Configuration, 6-99
screen, initial display, 3-8
selecting menus, 6-1
self test, 3-5
Sending Waveforms To a Computer, 6-102
- sensitivity, increasing, 6-21
Service Normalizations, 6-110
service request (SRQ), 6-112
Setting the RF Attenuation, 6-6
Setting the Tracking Generator Amplitude, 6-81
settings
 fragile, C-4
 mode-related, C-2
 precious, C-2
settings box, 1-2
settings, keypad entry, 6-87
short holdoff, 6-104
sideband analyzer interface, 7-1
signal size, 6-102
signal sources, A-1
signal track, 5-33
signals, resolving, 5-11
[SINGLE], 4-12
single sweep, 5-19
slashes (/), 1-4
software controls, 6-1
Sounds, 3-12
source impedance, 6-8
span per division control, 5-2
span per division, maximum, 5-4
span per division, zero, 5-4
[SPAN/DIV], 4-6,5-2
span/division, 1-5,3-17
specifications
 electrical, 2-1
 environmental, 2-13
 physical, 2-14
SPECTRAL DISPLAY IN MENUS, 6-104
spectral display mode, 4-2
spectrum, 1-5
spectrum analyzer, defined, 1-5
spectrum analyzer, heterodyne, 1-5

V

versatility, enhanced,	5-10
VERT POS,	5-38
VERT SCALE,	5-15
vertical scale,	4-10
vertical scale control,	5-15
vertical scale function block,	4-10
VF WIDE, VF (bandwidth),	5-14
[VID FLTR],	4-12,5-14
<i>Video Demodulation</i> ,	6-74
video filter,	5-13
video filter, manual setting,	6-88
video input,	7-4
video output,	7-5
video trigger modes,	6-116
voltage limitations,	xi
volume, AM/FM,	5-20

W

WAIT FOR END	
OF SWEEP,	6-123
WAIT FOR LIMIT,	6-123
WARMUP TIME 15 MIN,	3-5
WARNING,	vi
warnings,	B-1
waterfall mode,	5-25
waveforms, computer,	6-102
weight,	1-6
wet/damp conditions,	ix
<i>What Is A Spectrum Analyzer?</i> ,	1-5

Z

[ZERO] SPAN,	5-4
zero span,	1-5,4-7