

Instructions

Tektronix

**P6117
200 MHz 10X Passive Probe**

070-9729-00

CE

Copyright © Tektronix, Inc. All rights reserved.

Tektronix products are covered by U.S. and foreign patents, issued and pending. Information in this publication supercedes that in all previously published material. Specifications and price change privileges reserved.

Printed in the U.S.A.

Tektronix, Inc., P.O. Box 1000, Wilsonville, OR 97070-1000

TEKTRONIX and TEK are registered trademarks of Tektronix, Inc.

General Safety Summary

Review the following safety precautions to avoid injury and prevent damage to this product or any products connected to it. To avoid potential hazards, use product only as specified.

Only qualified personnel should perform service procedures.

Injury Precautions

Avoid Electric Overload. To avoid injury or fire hazard, do not apply potential to any input, including the common inputs, that varies from ground by more than the maximum rating for that input.

Avoid Electric Shock. To avoid injury, do not connect or disconnect probes or test leads while they are connected to a voltage source.

Do Not Operate in an Explosive Atmosphere. To avoid injury or fire hazard, do not operate this product in an explosive atmosphere.

Keep Probe Surface Clean and Dry. To avoid electric shock and erroneous readings, keep probe surface clean and dry.

Product Damage Precautions

Do Not Operate With Suspected Failures. If you suspect there is damage to this product, have it inspected by qualified service personnel.

Do Not Immerse in Liquids. Clean the probe using only a damp cloth. Refer to *Cleaning Instructions*, page ii.

Safety Terms and Symbols

Terms in This Manual. These terms may appear in this manual:



WARNING. Warning statements identify conditions or practices that could result in injury or loss of life.



CAUTION. Caution statements identify conditions or practices that could result in damage to this product or other property.

Terms on the Product. These terms may appear on the product:

DANGER indicates an injury hazard immediately accessible as you read the marking.

WARNING indicates an injury hazard not immediately accessible as you read the marking.

CAUTION indicates a hazard to property including the product.

Symbols on the Product. These symbols may appear on the product:



DANGER
High Voltage



Protective Ground
(Earth) Terminal



ATTENTION
Refer to Manual

Certifications and Compliances

Compliances. Consult the product specifications for Overvoltage Category and Safety Class.

Overvoltage Category. Overvoltage categories are defined as follows:

CAT III: Distribution level mains, fixed installation

CAT II: Local level mains, appliances, portable equipment

CAT I: Signal level, special equipment or parts of equipment, telecommunication, electronics

Cleaning Instructions

Clean the probe using a soft cloth dampened with a mild detergent and water solution. Do not use any other chemicals or abrasives.

Features and Accessories

The P6117 passive probe is designed for use with a THS700-, THS700A-, or THS700P-series oscilloscope that has a bandwidth of 200 MHz or less. The probe is listed with Underwriters Laboratories Inc. and meets the requirements of UL 3111-1.

NOTE. Remove and discard the protective cover on the tip of the probe before attempting to connect a probe tip accessory.

P6117 Features and Standard Accessories

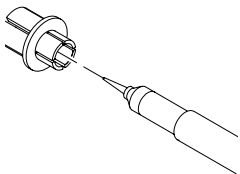

BNC-to-Probe Tip Adapter – To install the adapter, push the wide end firmly into a BNC connector. Then, insert the probe tip firmly into the adapter.

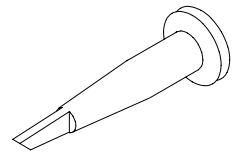

Retractable Hook Tip – Use the retractable hook tip to make hands-free measurements.

NOTE. To ensure a proper connection, firmly push and twist the hook tip onto the probe.

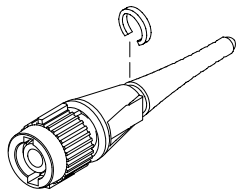

Marker Rings – To identify probe connections, attach matching colored rings onto the probe cable and tip as shown.

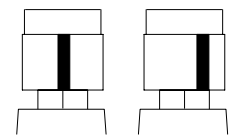

Locking Connector – Install the connector in the unlocked position and turn it clockwise until it snaps into the locked position.

Unlocked Locked

Features and Accessories

P6117 Features and Standard Accessories (Cont.)

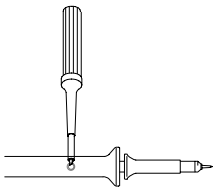

Adjustment Tool – Use the adjustment tool for probe compensation adjustments.

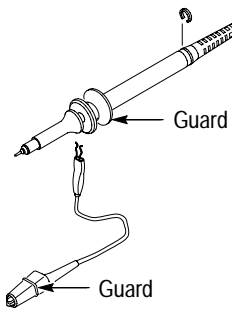

Ground Lead – Use the alligator clip to attach the probe to a ground reference. Attach matching marker ring as shown.



WARNING. To avoid electric shock when using the probe, keep fingers behind the guards that are on the probe body and ground clip.

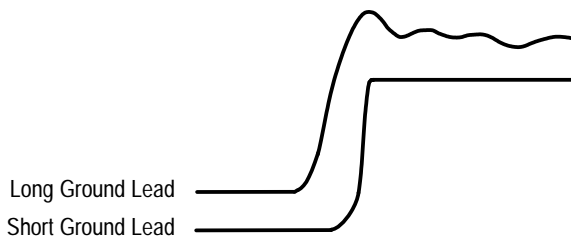

To see the best signal, use the shortest possible ground lead and signal path.

Probe Compensation

Check the compensation of the probe whenever you move the probe to a different channel. Compensate the probe as follows:

NOTE. *If you use a hook tip, firmly push and twist the hook tip onto the probe to ensure a proper connection.*

1. Connect the probe to the Probe Comp signal on your THS700-series oscilloscope and then press **AUTORANGE**.

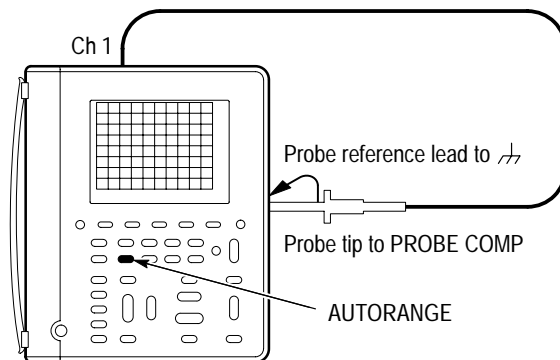

2. Compensate the probe by adjusting the trimmer on the probe so that the corners of the signal are square.

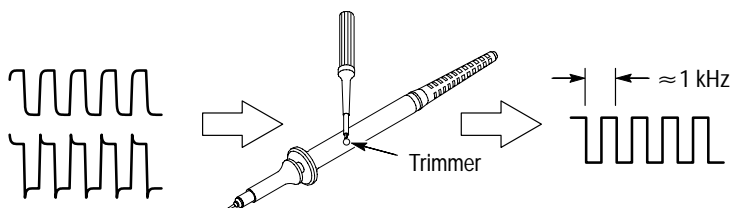

Specifications

The characteristics listed in Table 1 apply to a P6117 passive probe installed on a Tektronix THS700-, THS700A-, or THS700P-series oscilloscope unless otherwise noted.

These specifications apply when the instrument has had a warm-up period of at least 10 minutes and is in an environment that does not exceed the limits described in Table 2.

Table 1: Electrical characteristics

System attenuation (DC coupled system)	$10X \pm 2\%$ at DC
System input resistance, typical (DC coupled system)	$10\text{ M}\Omega \pm 1.5\%$
System input capacitance, typical (DC coupled system)	13.3 pF
System compensation range, typical	$25\text{ pF} \pm 2\text{ pF}$
System rise time, typical (DC coupled system)	1.75 ns (THS730A) 3.5 ns (THS720, THS720A, or THS720P) 5.8 ns (THS710 or THS710A)
System bandwidth (-3 dB, DC coupled system)	DC to 200 MHz (THS730A) DC to 100 MHz (THS720, THS720A, or THS720P) DC to 60 MHz (THS710 or THS710A)

Specifications

Table 1: Electrical characteristics (Cont.)

Maximum rated input voltage (Refer to Figure 1)	<i>Installation Category</i>	<i>Maximum Voltage</i>
	Category I & II	(AC or DC)
	probe tip to common	300 V _{RMS}
	probe tip to earth	300 V _{RMS}
	probe common to earth	30 V _{RMS}
	Category III	(AC or DC)
	probe tip to common	150 V _{RMS}
	probe tip to earth	150 V _{RMS}
	probe common to earth	30 V _{RMS}
Safety	UL3111-1, First Edition CSA C22.2 No. 1010.1-92 EN61010-1/A2 EN61010-2-031 Overvoltage Category II, Pollution Degree 2	
EC Declaration of Conformity	Compliance was demonstrated to the following specification as listed in the Official Journal of the European Communities: Low Voltage Directive 73/23/EEC, as amended by 93/68/EEC: EN 61010-1 Safety requirements for electrical equipment for measurement, control, and laboratory use EN 61010-2-031:1994 Particular requirements for hand-held probe assemblies for electrical measurement and test	
Pollution degree 2	Do not operate in environments where conductive pollutants may be present	

Specifications

Table 2: Physical and environmental characteristics

Net weight (including accessories)	110 g (0.243 lb)
Cable length	2 meters (78.74 in)
Temperature range ¹	
Operating	-15° C to +55° C (+5° F to +131° F)
Nonoperating	-62° C to +85° C (-80° F to +185° F)
Humidity ¹	Tested at 95% to 97% relative humidity (30°C to 55°C)

¹ Tektronix Standard 062-2847-00, class 3.

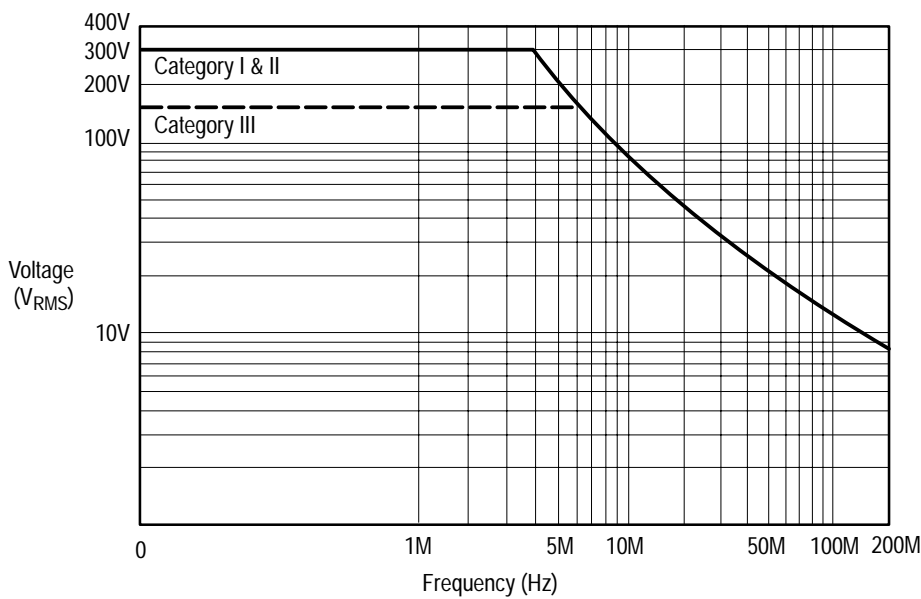
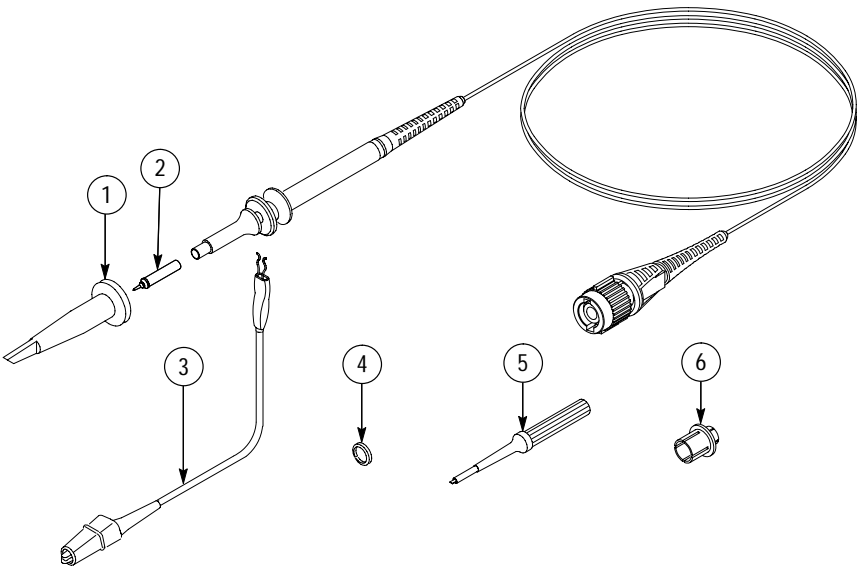
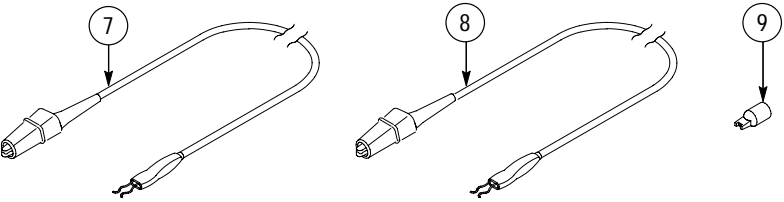

Figure 1: Maximum input voltage derating curve (V_{RMS}, DC Coupled)

Replaceable Parts



Standard Accessories



Optional Accessories

Figure 2: P6117 replaceable parts

Replaceable Parts List

Replaceable Parts

Fig. & Index Number	Tektronix Part Number	Serial No. Effective	Serial No. Discont'd	Qty	Name & Description	Mfr. Code	Mfr. Part Number
2-				1	PROBE,PASSIVE:P6117		
					STANDARD ACCESSORIES		
-1	013-0107-08			1	TIP,PROBE:MINIATURE/COMPACT SIZE,BLACK	TK2565	013-0107-08
-2	See Opt. Acc			1	CONTACT,ELEC:PROBE TIP W/INSULATOR ASSY		
-3	196-3120-01			1	LEAD,ELECTRICAL:PROBE GND,6.0 L	80009	196-3120-01
-4	016-0633-00			1	MARKER SET,CA-2 EA VARIOUS COLORS	80009	016-0633-00
-5	See Opt. Acc.			1	SCREWDRIVER:ADJUSTMENT TOOL		
-6	013-0277-00			1	ADAPTER,CONN:BNC TO MINIATURE PROBE TIP	24931	33A129-1
	070-9729-00			1	MANUAL,TECH:INSTR, P6117, DP	80009	070-9729-00
					OPTIONAL ACCESSORIES		
-2	131-4997-01			1	CONTACT,ELEC:2 TIP-INSULATOR W/INFO CARD	80009	131-4997-01
-5	003-1433-01			1	SCREWDRIVER:ADJUSTMENT TOOL,PKG OF 5	80009	003-1433-01
-7	196-3120-21			1	LEAD,ELECTRICAL:PROBE GND,28.0 L	80009	196-3120-21
-8	196-3121-01			1	LEAD,ELECTRICAL:PROBE GND,12.0 L	80009	196-3121-01
-9	015-0201-07			1	TIP,PROBE:IC TEST,PKG OF 10	80009	015-0201-07
	013-0107-08			1	TIP,PROBE:MINIATURE/COMPACT SIZE,BLACK	TK2565	013-0107-08

Manufacturers Cross Index

Mfr. Code	Manufacturer	Address	City, State, Zip Code
24931	BERG ELECTRONICS INC	BERG ELECTRONICS RF/COAXIAL DIV 2100 EARLYWOOD DR PO BOX 547	FRANKLIN, IN 46131
80009	TEKTRONIX INC	14150 SW KARL BRAUN DR PO BOX 500	BEAVERTON, OR 97077-0001
TK2565	VISION PLASTICS INC	26000 SW PARKWAY CENTER DRIVE	WILSONVILLE, OR 97070

Replaceable Parts

WARRANTY

Tektronix warrants that the products that it manufactures and sells will be free from defects in materials and workmanship for a period of one (1) year from the date of purchase from an authorized Tektronix distributor. If any such product proves defective during this warranty period, Tektronix, at its option, either will repair the defective product without charge for parts and labor, or will provide a replacement in exchange for the defective product. Batteries are excluded from this warranty.

In order to obtain service under this warranty, Customer must notify Tektronix of the defect before the expiration of the warranty period and make suitable arrangements for the performance of service. Customer shall be responsible for packaging and shipping the defective product to the service center designated by Tektronix, shipping charges prepaid, and with a copy of customer proof of purchase. Tektronix shall pay for the return of the product to Customer if the shipment is to a location within the country in which the Tektronix service center is located. Customer shall be responsible for paying all shipping charges, duties, taxes, and any other charges for products returned to any other locations.

This warranty shall not apply to any defect, failure or damage caused by improper use or improper or inadequate maintenance and care. Tektronix shall not be obligated to furnish service under this warranty a) to repair damage resulting from attempts by personnel other than Tektronix representatives to install, repair or service the product; b) to repair damage resulting from improper use or connection to incompatible equipment; c) to repair any damage or malfunction caused by the use of non-Tektronix supplies; or d) to service a product that has been modified or integrated with other products when the effect of such modification or integration increases the time or difficulty of servicing the product.

THIS WARRANTY IS GIVEN BY TEKTRONIX WITH RESPECT TO THE LISTED PRODUCTS IN LIEU OF ANY OTHER WARRANTIES, EXPRESS OR IMPLIED. TEKTRONIX AND ITS VENDORS DISCLAIM ANY IMPLIED WARRANTIES OF MERCHANTABILITY OR FITNESS FOR A PARTICULAR PURPOSE. TEKTRONIX' RESPONSIBILITY TO REPAIR OR REPLACE DEFECTIVE PRODUCTS IS THE SOLE AND EXCLUSIVE REMEDY PROVIDED TO THE CUSTOMER FOR BREACH OF THIS WARRANTY. TEKTRONIX AND ITS VENDORS WILL NOT BE LIABLE FOR ANY INDIRECT, SPECIAL, INCIDENTAL, OR CONSEQUENTIAL DAMAGES IRRESPECTIVE OF WHETHER TEKTRONIX OR THE VENDOR HAS ADVANCE NOTICE OF THE POSSIBILITY OF SUCH DAMAGES.