

2295-33

Fig. 4-25. Equipment Setup for Calibrating Sweep Timing.

h. Connect test setup as shown in Fig. 4-25. The input signal to the 7L18 will be modulated by time-markers. Set the 7L18 front panel controls as follows:

CENTER FREQUENCY	2.0 GHz
Display Mode	10 dB/DIV
REFERENCE LEVEL	-30 dBm
RF Attenuator	0 dB
TRIGGERING	INT/EXT
TIME/DIV	20 ms
FREQ SPAN/DIV	2 MHz
RESOLUTION BANDWIDTH	300 kHz
Digital Storage	Off
PHASE LOCK	Off
PULSE STRETCHER	On

i. Apply 20 ms time marks to modulate the 2.0 GHz calibrator signal. Tune the signal to center screen. Change the Display Mode to 2 dB/DIV and reduce the FREQ SPAN/DIV to 0, keeping time markers on screen with the Center Frequency tuning control.

j. Detune the center frequency so positive trigger pulses are displayed and adjust the REF VAR for a triggered display (see Fig. 4-26).

k. Use the HORIZ POSITION control to align time marks to their respective graticule lines while adjusting the front panel SWP CAL for 1 marker/div.

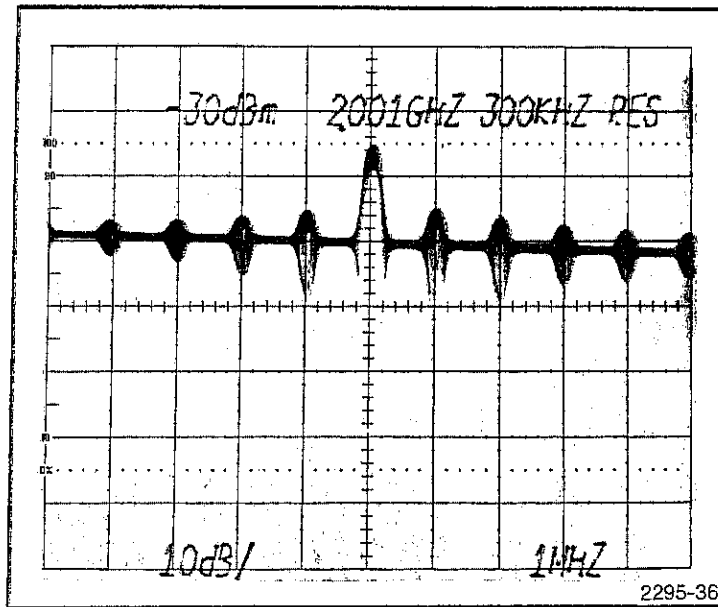

Fig. 4-28. 1 MHz Beat Notes as Seen on the Display for Calibrating the 1st LO FM Coil Drive.

b. Apply 1 μ s markers through the Harmonic Modulator to the 7L18 R.F. input.

c. Tune the CENTER FREQUENCY to keep the beat nodes aligned with the graticule lines while the FM Coil Gain, R1389, (see Fig. 4-24) is adjusted for one marker/div (see Fig. 4-28).

d. Disconnect the test equipment to the 7L18.

3. Adjust the 1st Local Oscillator Tuning Coil Drive Voltage and Calibrate Digital Voltmeter Readout

a. Set the front panel controls as follows:

Display Mode	LOG 10 dB/DIV
TIME/DIV	AUTO or 10 ms
Band Selection	1.5—3.5 (Band 1)
RESOLUTION BANDWIDTH	AUTO or 3 MHz
Reference Level	-30 dBm
FREQ SPAN/DIV	100 MHz
Digital Storage	Off

b. Apply the output of a 100 MHz Comb generator to the 7L18 RF INPUT. If a Comb generator is not available, apply the CAL OUT signal to the RF INPUT. If the CAL OUT is used, first verify that its performance is within specifications.

c. Adjust Tune Coil Slope R2172 (see Fig. 4-29) for 100 MHz markers per division. If using the Cal Out signal, adjust for 500 MHz per five divisions.

d. Using a DVM or a dc-coupled test oscilloscope, adjust RF Voltage (Adj R2352) on the Reference Voltage board (see Fig. 4-30) -10.0 volts between pin W and Tune Ref Gnd (pin J) on the Preselector Driver board (see Fig. 4-29).

e. Change the FREQ.SPAN/DIV to 2 MHz and measure the voltage at pin T of the Preselector Driver board (see Fig. 4-29). Adjust CENTER FREQUENCY control for a reading of 0 volt (center frequency is not at the center of the band, or 2.490 GHz).

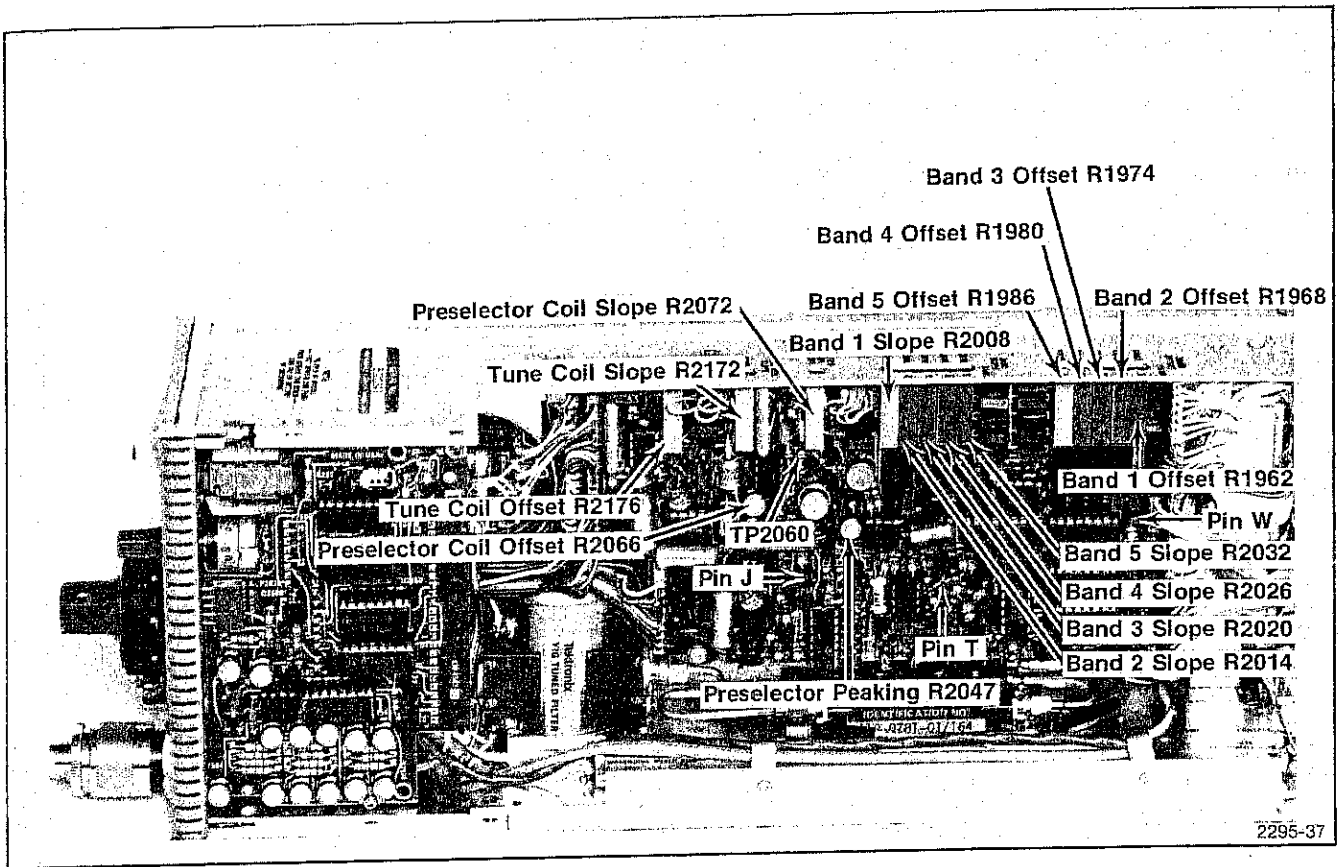

Fig. 4-29. Adjustments and Test Point Location on the 1st LO and Preselector Driver.

f. Adjust Tune Coil Offset R2176 (see Fig. 4-29) so the 2.5 GHz marker is on the far right graticule line. This is 10 MHz above center.

g. Press and release DEGAUSS. The 2.5 GHz marker should return to the far right graticule line. If it does not, readjust R2176 as necessary.

NOTE

If the preselector will not pass a signal, proceed to part n of this step. If it will pass a signal, continue with part h of this step.

h. Midrange the front panel Center Frequency CAL adjustment.

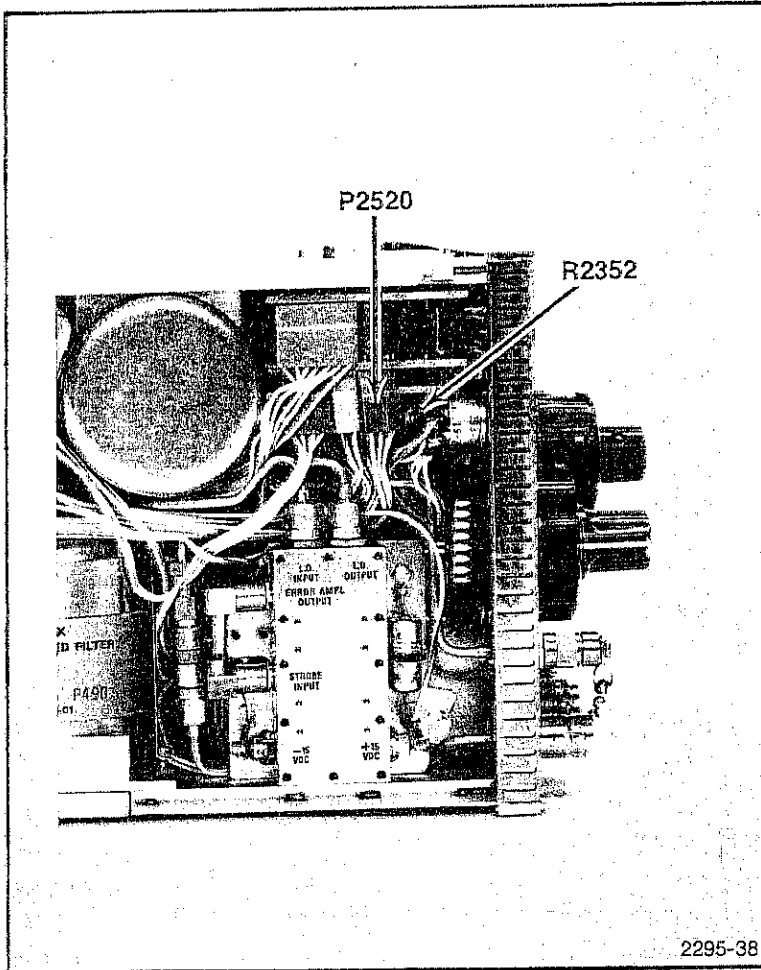

Fig. 4-30. Location of Reference Voltage Adjust and P2520.

i. Adjust Offset R475 (see Fig. 4-31) for a Center Frequency readout of 2.490 GHz.

j. Increase the span to 100 MHz/div and tune the 1.5 GHz signal to center screen.

k. Press the DEGAUSS button and decrease the SPAN/DIV to 2 MHz, keeping the signal centered with the tuning control.

l. Adjust Gain R455 on the Center Frequency DVM board (see Fig. 4-31) for a readout of 1.5 GHz.

m. Repeat parts i through l of this step to minimize interaction.

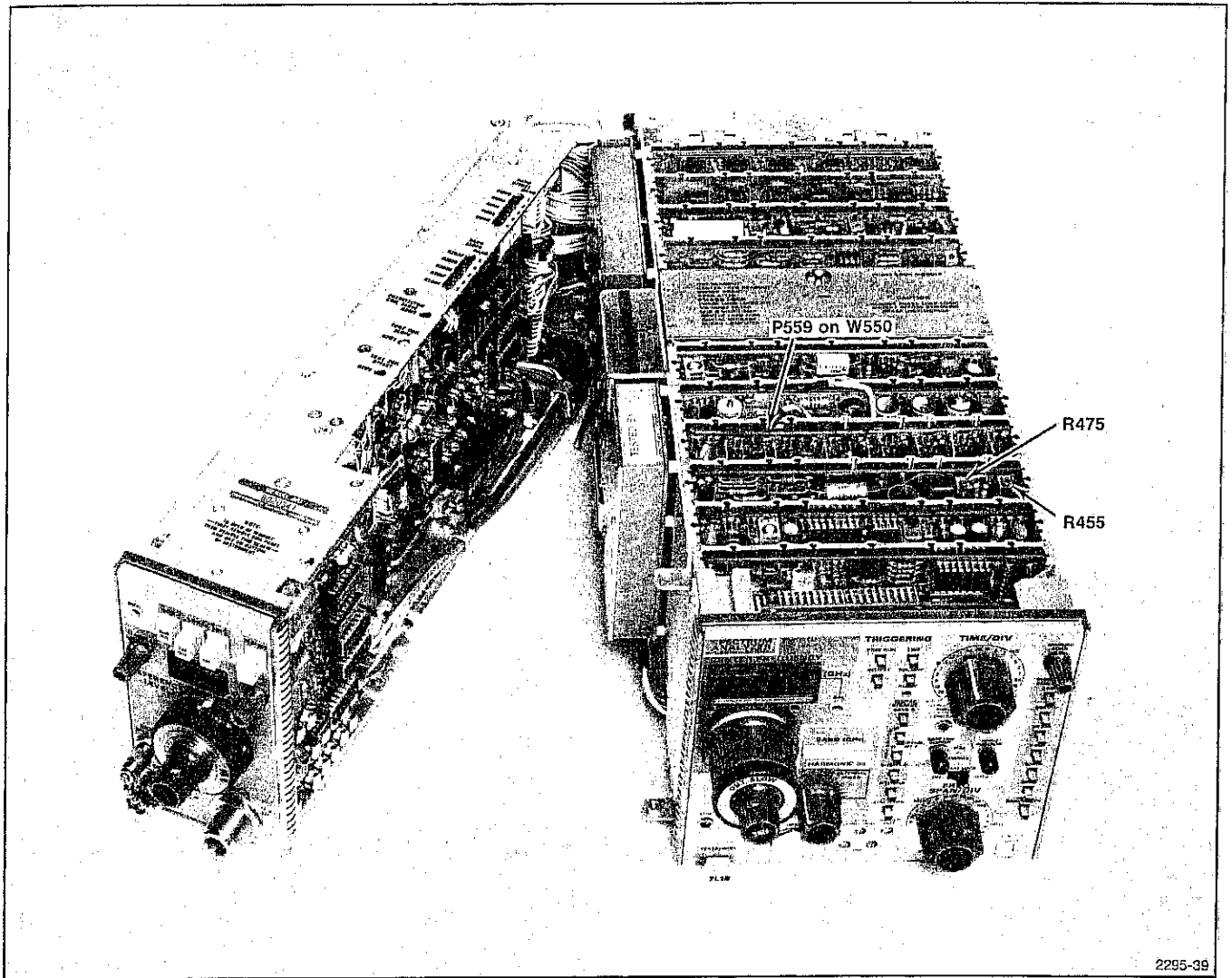

Fig. 4-31. Location of Adjustments on Center Frequency DVM.

n. Use the following procedure to calibrate the DVM only if the pre-selector will not pass a signal!

1. Apply the CAL OUT signal to the EXT MIXER input through a coaxial cable and BNC to SMA adapter.

2. With the FREQ SPAN/DIV at 2 MHz and the CENTER FREQUENCY set for 0 V at pin T of the Preselector Driver (see Fig. 4-29), the display should contain both the 2.5 GHz calibrator signal and its lower image response.

3. Press and release DEGAUSS, then adjust Tune Coil Offset R2176 (see Fig. 4-29) to position the 2.5 GHz marker on the far right graticule line.

4. With the front panel CAL adjustment centered, adjust Center Frequency DVM Offset R475 (see Fig. 4-31) for a readout of 2.490 GHz.

5. Tune the 1.5 GHz signal to center screen. As the 1.5 GHz signal approaches center screen, press and release DEGAUSS.

6. Adjust DVM Gain R555 (see Fig. 4-31) for a readout of 1.5 GHz.

7. Remove the Cal signal to the EXT MIXER input and replace the 50 Ω terminator.

4. Calibration of the Log Amplifier

a. To gain access to the adjustable components of this circuitry, the Log and Video Amp Module Assembly must be extended from the instrument. Remove the shield plate between the Log and Video Amplifier and Center Frequency DVM modules, then remove the Log and Video Amplifier module as previously described. Test equipment setup is shown in Fig. 4-32.

b. Disconnect the signal cable, W550, between the Log Amplifier board input and the output from the VR Noise Filter board (see Fig. 4-31).

c. Set the 7L18 front panel controls as follows:

FREQ SPAN/DIV	1 MHz
RESOLUTION BANDWIDTH	AUTO
RF ATTENUATOR	0 dB
REFERENCE LEVEL	-60 dBm
TIME/DIV	AUTO
Digital Storage	Off
REF VAR	CAL detent
Display Mode	Switches disengaged (out)

d. Apply a -50 dBm, 10 MHz signal from a signal generator through 10 dB and 1 dB step attenuators, to the input of the Log Amplifier, pins 1 and 2 of J559 (refer to Fig. 31 or 32).

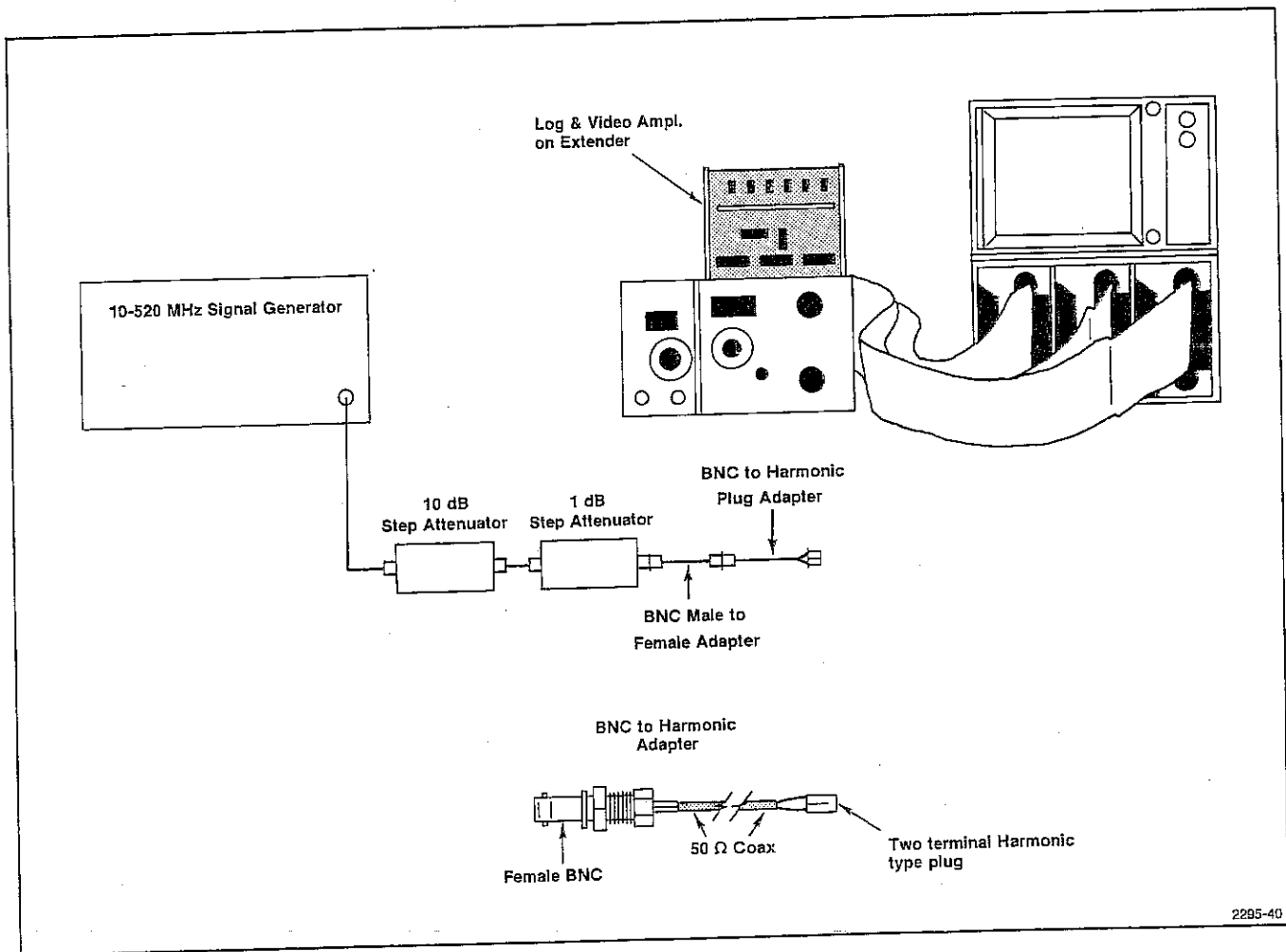

Fig. 4-32. Log and Video Amplifier Module on an Extender, Ready for Calibration.

e. Switch the REFERENCE LEVEL from -60 dBm to -100 dBm in 10 dB steps while adjusting front panel LOG CAL for one division increase per step.

f. Reconnect P2520 to the Display Mode board, set the REFERENCE LEVEL to -30 dBm, the Display Mode to 2 dB/DIV, and the signal generator output to 0 dBm.

g. Change the REFERENCE LEVEL 10 dB by switching to -20 dBm and adjust 2 dB/Div, R805, (see Fig. 4-33) for five divisions of change.

h. Set the Display Mode to 10 dB/DIV and the REFERENCE LEVEL to -30 dBm. Ensure the signal generator output is still 0 dBm.

i. Switch in 70 dB of attenuation in 10 dB steps and set 10 dB/div adjust, R725, (see Fig. 4-33) for the best 10 dB/div accuracy.

j. Return the step attenuators to 0 dB. Adjust 10 dB/div Reference Level R775 (see Fig. 4-33) for full screen signal.

k. Change the Display Mode to 2 dB/DIV. Adjust 2 dB/div Reference Level, R780, (see Fig. 4-33) for full screen signal.

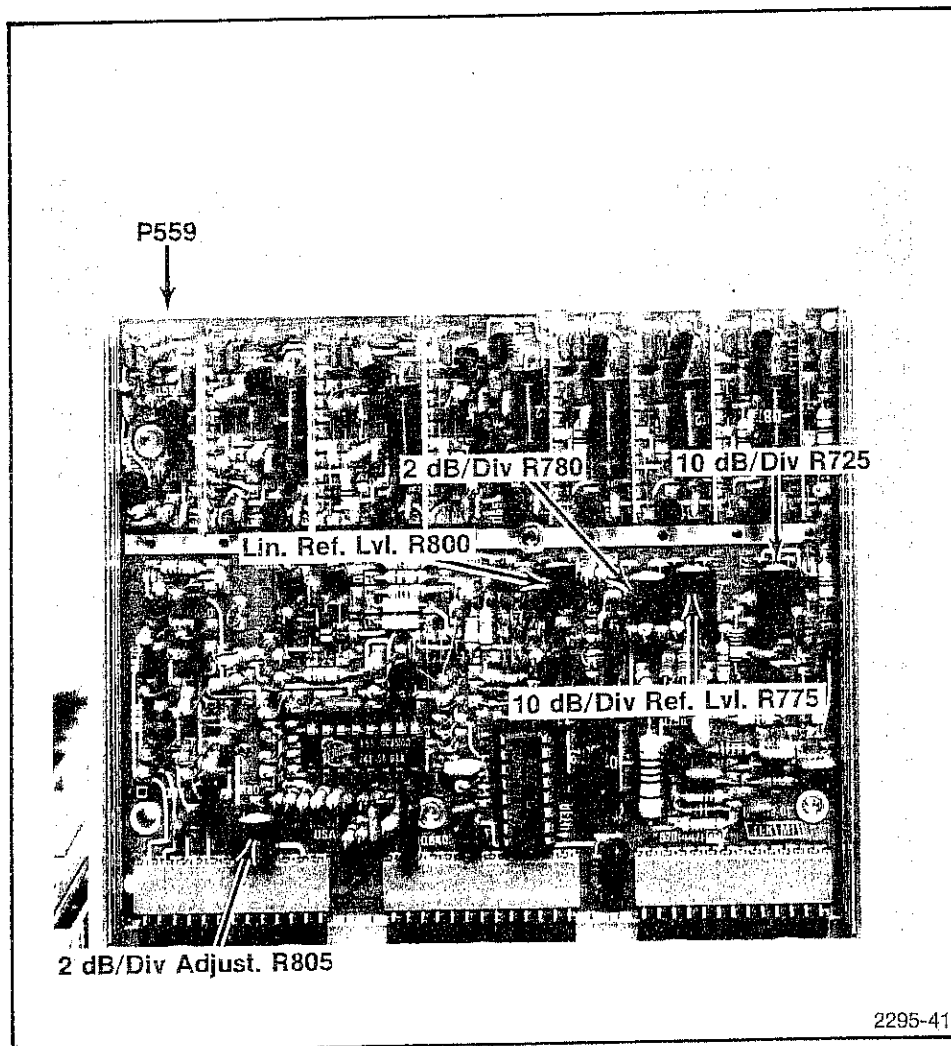

Fig. 4-33. Log and Video Amplifier Test Points and Adjustments.

Calibration—7L18 Interim Service

l. Change the Display Mode to LIN. Adjust LIN Reference Level, R800, (see Fig. 4-33) for full screen signal.

m. Disconnect test setup, and reconnect cable W550 between the Noise Filter output and the input to the Log Amplifier board. Remove the extender and return the Log and Video Amplifier module to its normal position.

CAUTION

Ensure that the interconnect cable, W550, is in the VR Noise Filter board notch before installing the shield plate between the two module assemblies.

5. Calibration of the Phase Lock Control

The Phase Lock module must be operative and the Phase Lock Logic Control module on an extender. Test setup is shown in Fig. 4-34. This procedure checks beat-note levels into the Phase Lock Control, sets the loop gain and the 50 kHz span for phase lock operation.

a. Set Loop Gain, R1184, (see Fig. 4-35) fully counterclockwise (ccw).

b. Set the front panel FREQ SPAN/DIV to 50 kHz, and the Band selector to 1.5—3.5 GHz.

c. Replace the 50-ohm termination on the EXT MIXER port with a 3 dB miniature fixed attenuator.

d. Connect a voltage probe, from the test oscilloscope, to the junction of H24 and R1182 (see Fig. 4-35) on the Phase Lock Logic Control board.

e. Tune across band 1 for the lowest beat-note level as observed on the test oscilloscope (use the coarse position of the Center Frequency tuning control).

f. Remove the voltage probe from the junction of R1182-H24 and connect it to the center tap of R1184. Use a shorting strap to ground TP1190 (see Fig. 4-35).

g. Adjust R1184 for a 1 ± 0.2 V peak-to-peak beat signal.

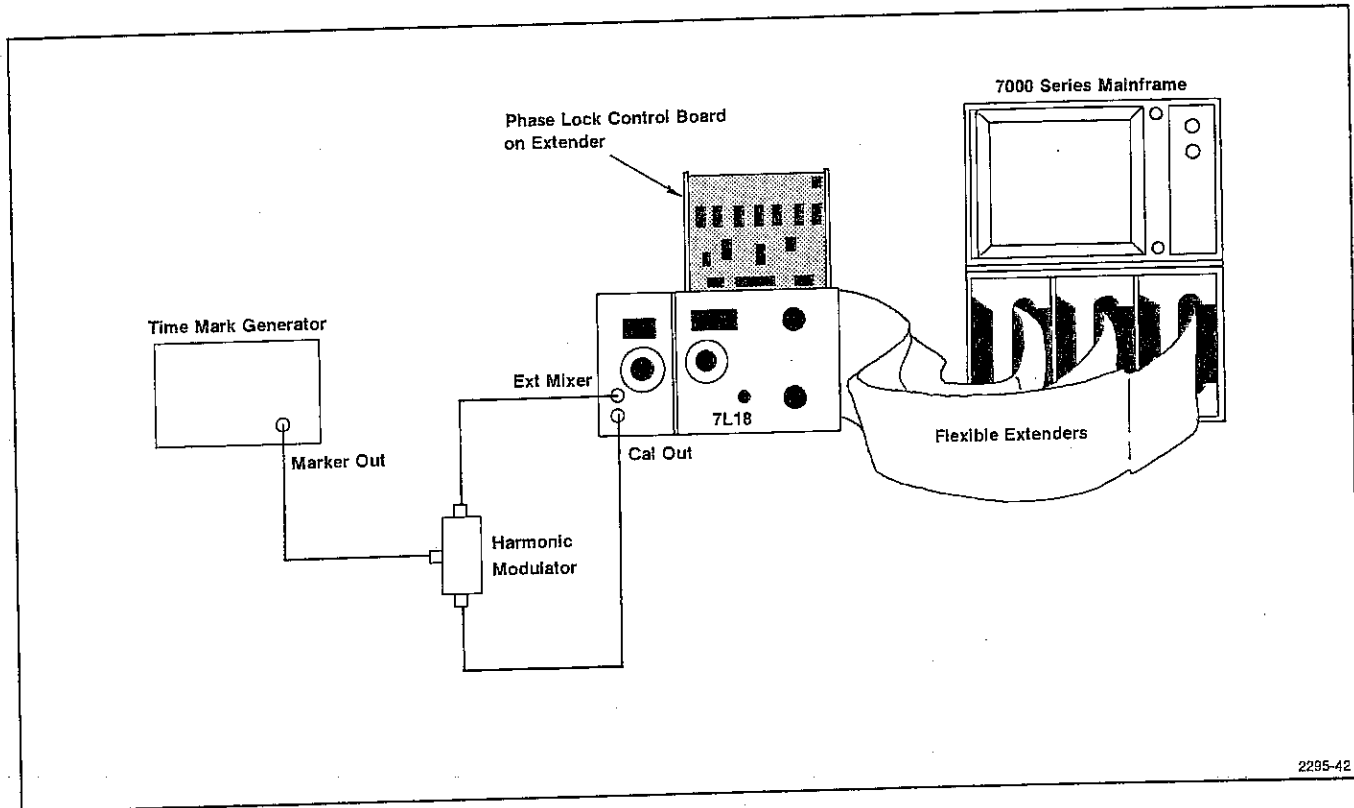

Fig. 4-34. Test Setup for Calibrating Phase Lock Control.

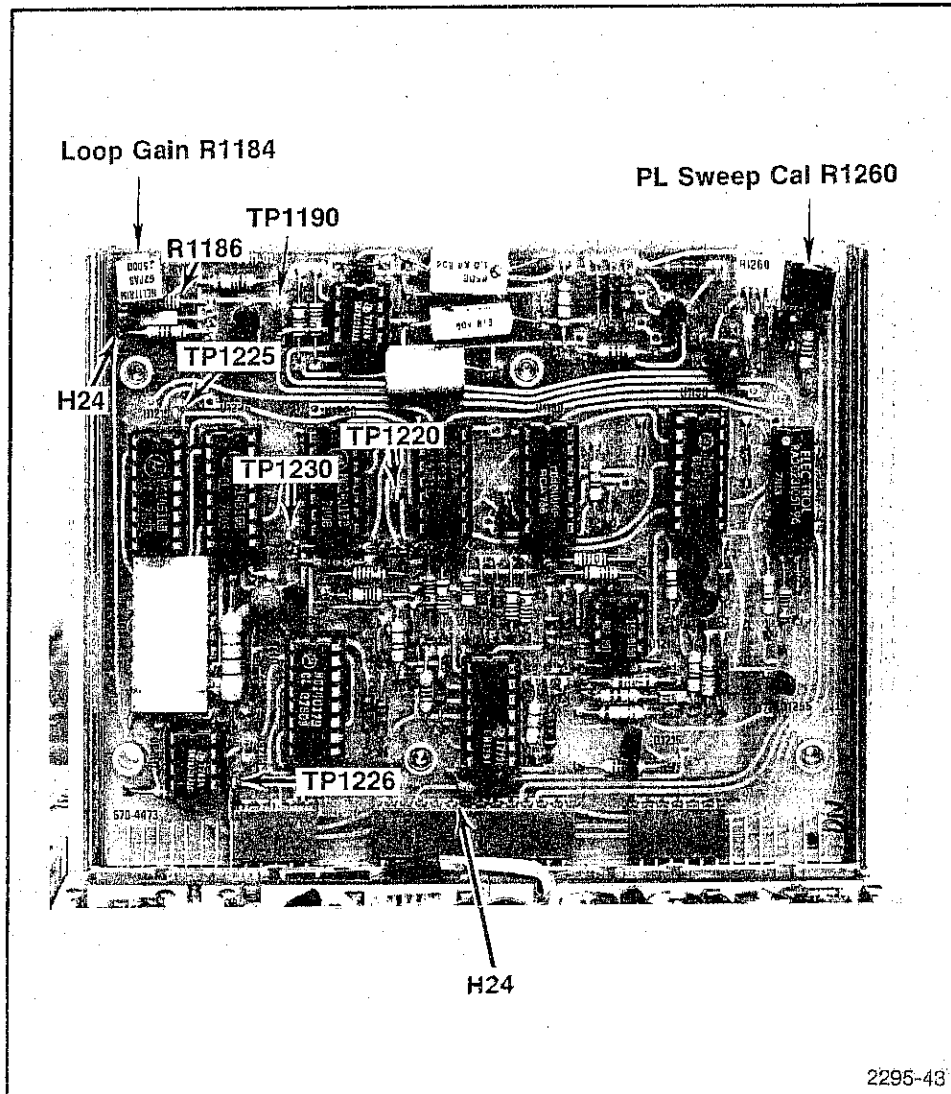

Fig. 4-35. Phase Lock Logic Control Test Points and Adjustments.

h. Remove the ground strap to TP1190 and replace the 3 dB attenuator with the 50-ohm TERMINATION.

i. Apply the CAL OUT signal through the Harmonic Modulator to the RF INPUT so the Calibrator signal is modulated with 20 μ s markers from the Time-Mark Generator (see Fig. 4-34).

j. With a 10 dB/DIV display, tune the 2.0 GHz calibrator signal to center screen; then reduce the FREQ SPAN/DIV to 50 kHz and the RESOLUTION BANDWIDTH to 3 kHz. Ensure PHASE LOCK is in the AUTO position. Set the TIME/DIV to 5 ms.

k. Adjust span for one marker/division with R1260 (see Fig. 4-35).

l. Change the SPAN/DIV to .2 MHz, and the Time-Mark Generator output to 5 μ s.

m. Adjust R1389 on the Span Attenuator (see Fig. 4-24) for one marker/division.

NOTE

R1389 is also an adjustment for the Sweep Amplitude and Timing (step 1 of this procedure). This readjustment ensures that the oscillator FM coil frequency span is correct over the center portion of the crt display.

n. Disconnect and remove external test equipment.

6. Presetting the Variable Resolution Gain Adjustments

a. Test equipment setup is as shown in Fig. 4-36.

b. Set the 7L18 controls as follows:

CENTER FREQUENCY	2.0 GHz
REFERENCE LEVEL	-30 dBm
TIME/DIV	5 ms
FREQ SPAN/DIV	0
RESOLUTION	300 Hz
Display Mode	2 dB/DIV
Digital Storage	Off

c. Disconnect P3455 from the output of the VR Noise Filter (see Fig. 4-36) and connect a power meter (i.e., HP 435A/8489A) to connector J3455. (Use a bnc-to-harmonic adapter such as that described for Adjusting Log Amplifier

module.) Disconnect P3174 (cable is input to 300 Hz Filter, see Fig. 4-36 or 4-37) on the VR module. Apply a 10 MHz, -10 dBm signal, from the signal generator, through a coaxial cable and bnc-to-male Sealectro adapter to the cable plug, P3174.

d. Set the 30 Hz Level, R3245 (Fig. 4-37), about 10° from the full clockwise position and set R3235, 300 Hz Gain, to mid-range.

e. Adjust the frequency of the signal generator for maximum indication on the power meter, then adjust VR Gain R3265 (see Fig. 4-37) for 0 dBm reading on the power meter.

f. Disconnect the power meter from connector J3455 and reconnect the cable (W550) to J3455.

g. Remove the signal generator signal from P3174 and reconnect P3174 to J3174.

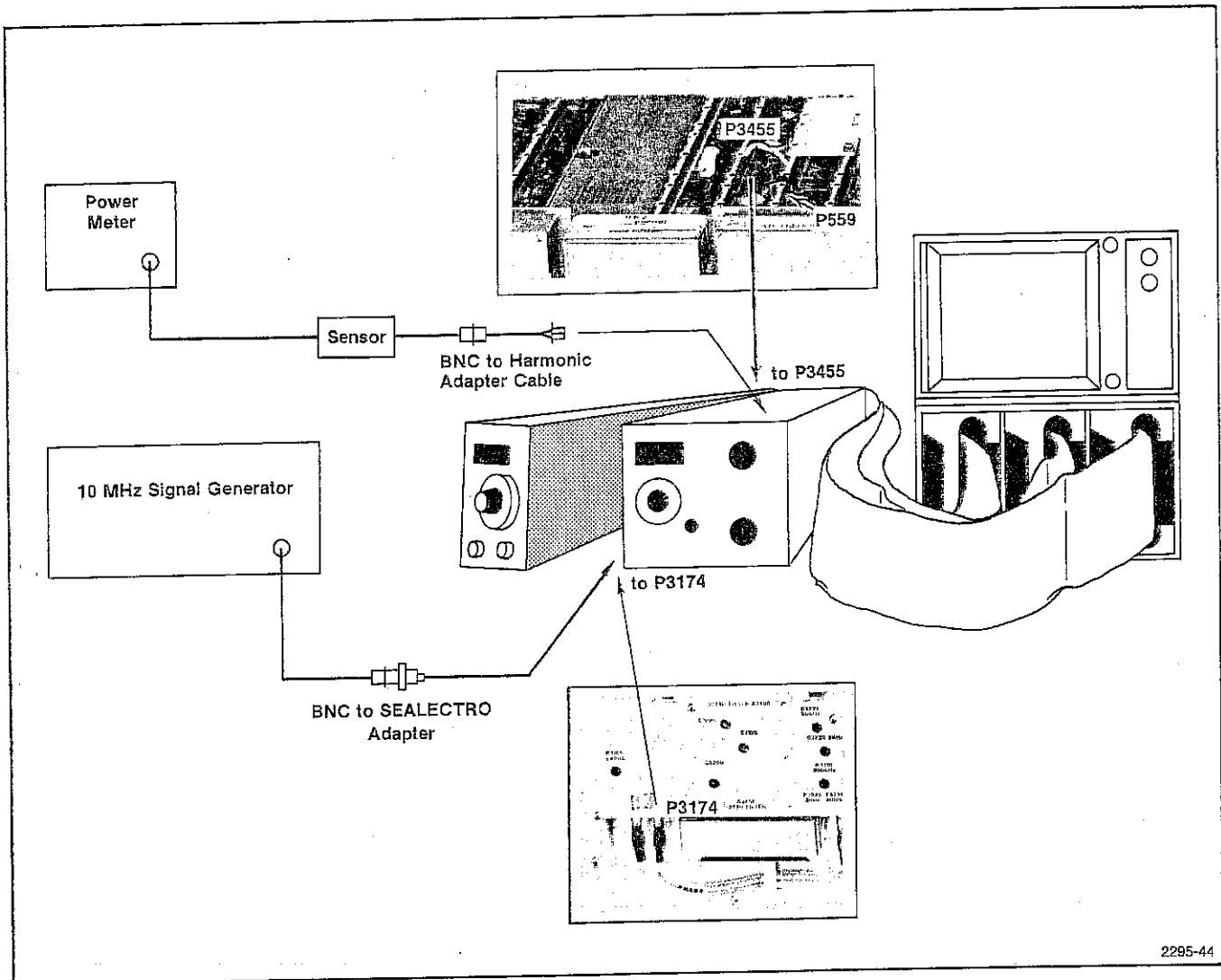

Fig. 4-36. Test Setup for Calibrating VR Circuits.

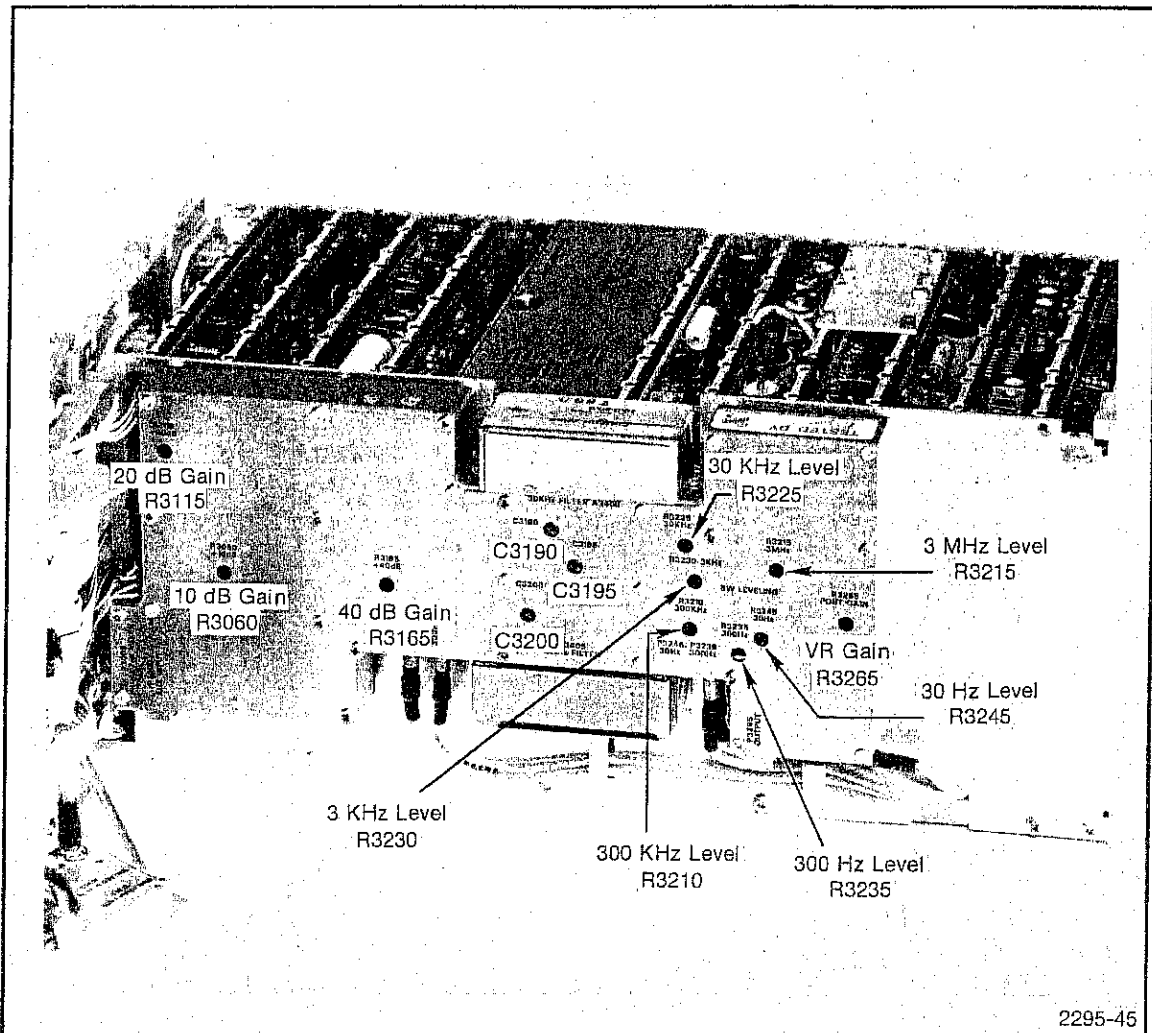

Fig. 4-37. Location of Connectors and Adjustments used When Calibrating the VR Circuits.

h. Disconnect P2484 (10 MHz Output on the 2nd Mixer assembly, see Fig. 4-38), then apply 10 MHz, -30 dBm signal from the signal generator through a 10 dB step attenuator and bnc-to-Sealectro adapter, to P2484.

i. Change the RESOLUTION BANDWIDTH to 30 Hz and adjust the frequency of the signal generator for maximum amplitude on the crt display.

j. Adjust the generator output gain for a display amplitude of seven (7) divisions. This will be the VR reference level for the other bandwidth selections.

k. Switch the RESOLUTION BANDWIDTH to 300 Hz and adjust the filter output gain, with 300 Hz Level R3235, (see Fig. 4-37), so the amplitude of the display equals the reference level established in part j.

l. Adjust the output of the remaining resolution bandwidth filters to the reference level with the following level adjustments (see Fig. 4-37):

3 kHz—adjust R3230

30 kHz—adjust R3225

300 kHz—peak C3190, C3195, and C3200; then adjust R3210

3 MHz—adjust R3215

m. Return the RESOLUTION BANDWIDTH to 300 Hz, then reduce the signal level 10 dB with the step attenuator and decrease the gain 10 dB by changing the REFERENCE LEVEL to -40 dBm.

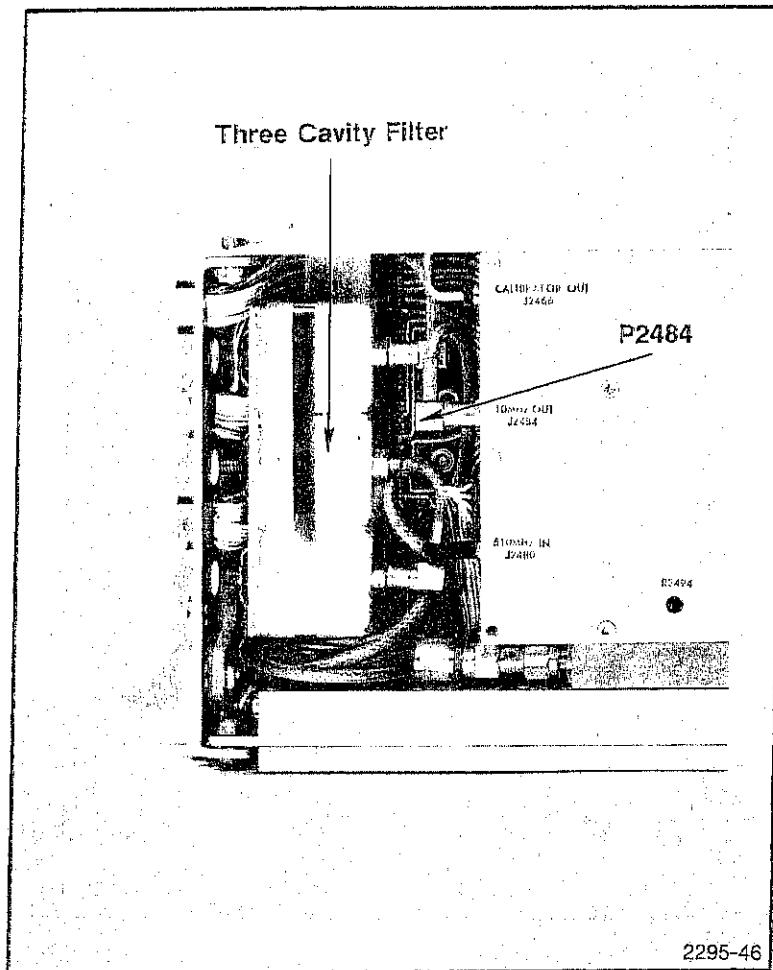

Fig. 4-38. Location of P2484 and 3-Cavity Filter.

n. Adjust 10 dB Gain R3060 (see Fig. 4-37) for a calibrated 10 dB of gain increase.

o. Reduce the input signal level an additional 10 dB for 20 dB of attenuation and set the REFERENCE LEVEL to -50 dB.

p. Adjust 20 dB Gain R3115 (see Fig. 4-37) for a calibrated 20 dB of gain increase.

q. Set the step attenuator for 80 dB of attenuation, the 7L18 REFERENCE LEVEL to -110 dBm.

r. Adjust 40 dB Gain R3165 (see Fig. 4-37) for a gain increase of 80 dB.

s. Disconnect the test equipment setup, replace P2484 to the output of the 2nd Mixer.

7. Calibration of the 510 MHz IF and Local Oscillators

NOTE

The 510 MHz IF circuits (chain) should only require calibration when the IF amplifier, waveguide band, or coaxial band resonator have been replaced and there is a problem getting the 7L18 to meet frequency response characteristics. A Return Loss Bridge is used to set the return loss.

a. This procedure requires the removal of the cover plate shown in Fig. 4-39. Use a 5/64" Allen driver to remove the 21 screws.

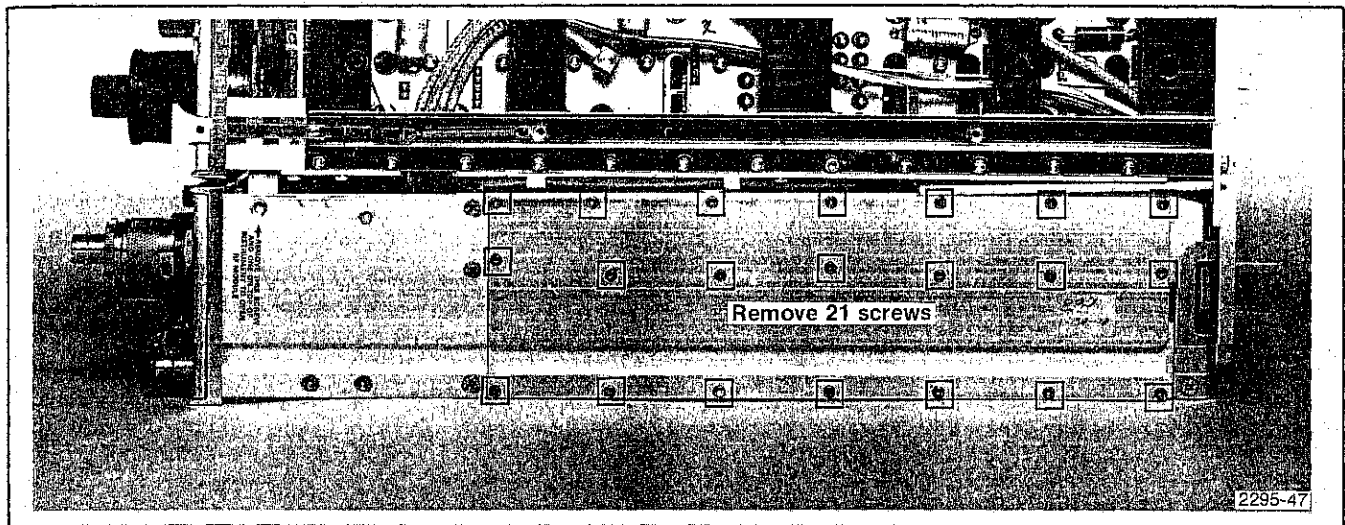

Fig. 4-39. Bottom of 7L18 Showing Location of 510 MHz IF Module.

- b. Test equipment setup is shown in Fig. 4-40A.
- c. Disconnect P40 and P44 from J2824 and J2816 (Fig. 4-40 or 4-41).
- d. Apply a 510 MHz, -50 dBm signal from a 50Ω signal source through a dc blocking capacitor to J2824 (Fig. 4-40A).
- e. Set the 7L18 band selector to 1.5—3.5 GHz and adjust REFERENCE LEVEL for an on-screen indication. It may be necessary to adjust Band 1 Gain R2574 on the Vertical Microcomputer Interface board (see Fig. 4-43), to midrange if a signal is not on-screen.
- f. Adjust Coaxial Resonator input tuning with C2821 (see Fig. 4-42) for maximum deflection.
- g. Remove the signal from J2824 and reconnect P40 to J2824, then apply the 510 MHz signal to J2816 (Fig. 4-41).
- h. Adjust Waveguide REsonator input tuning with C2815 (Fig. 4-42) for maximum deflection.
- i. Remove the signal from J2816 and reconnect P44 to J2816.
- j. Connect test equipment as shown in Fig. 4-40B. Apply a 510 MHz, -20 dBm signal through a vswr bridge to a test spectrum analyzer. Set the test spectrum analyzer Resolution Bandwidth to 3 MHz, Reference Level to -30 dBm, and Span/Div to 1 MHz. Set the signal level on the test spectrum analyzer to the top graticule line with the REF VAR control. Connect the second vswr output through a dc blocking capacitor to J2816 of the spectrum analyzer under test.
- k. Measure the return loss at 510 MHz. If return loss is less than 12 dB down from the reference, adjust C2815 (Fig. 4022) until the loss is at least 12 dB down.
- l. Remove the signal from J2816 and reconnect P44; then remove P40 from J2824 and apply the signal to J2824. Measure the vswr of the coaxial band resonator.
- m. If the return loss is less than 12 dB, adjust C2821 (Fig. 4-42) until the loss is at least 12 dB at 510 MHz.
- Disconnect the signal to J2824 and reconnect P40. Reinstall the 510 MHz IF amplifier cover assembly and disconnect the test equipment.

8. Calibration of the 500 MHz Local Oscillator (CAL OUT)

- a. Turn the POWER off, remove the cover plate on the 2nd Mixer and 500 MHz Local Oscillator assembly and the copper shield over the 2nd Mixer section (see Fig. 4-43). Set the front panel controls as follows:

CENTER FREQUENCY	2.0 GHz
FREQ SPAN/DIV	1 MHz
RESOLUTION BANDWIDTH	AUTO
TIME/DIV	AUTO
Display Mode	2 dB/DIV

NOTE

After the proper gain has been established through the 510 MHz IF, a return loss bridge should be used to adjust the return loss in the coaxial and waveguide resonators of the 510 MHz IF. If the return loss is not correct, noise levels and gain levels could be in error.

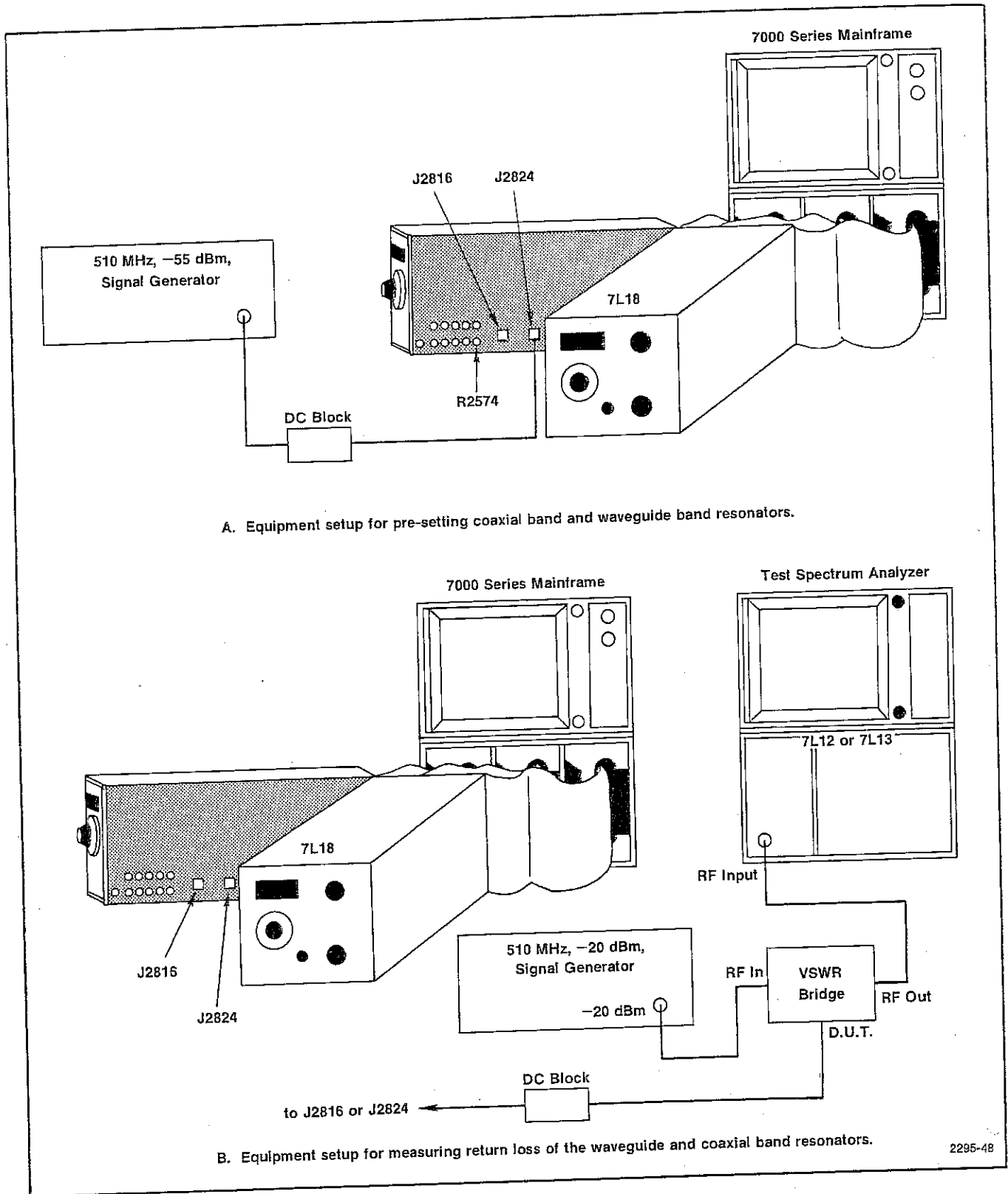

2295-48

Fig. 4-40. Test Setup for Calibrating 510 MHz IF.

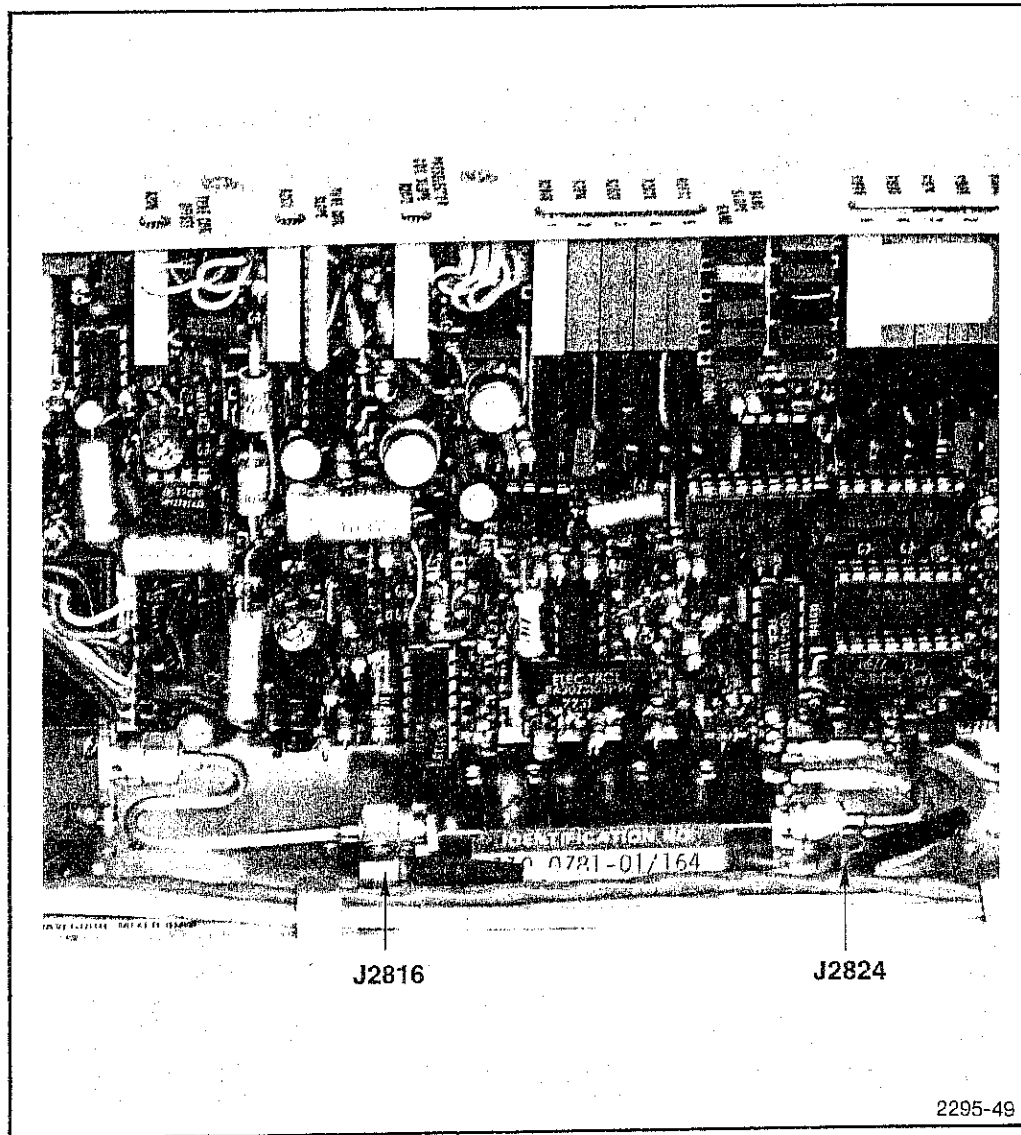

Fig. 4-41. Location of J2824, J2816 and Adjustments on Microcomputer Interface Board.

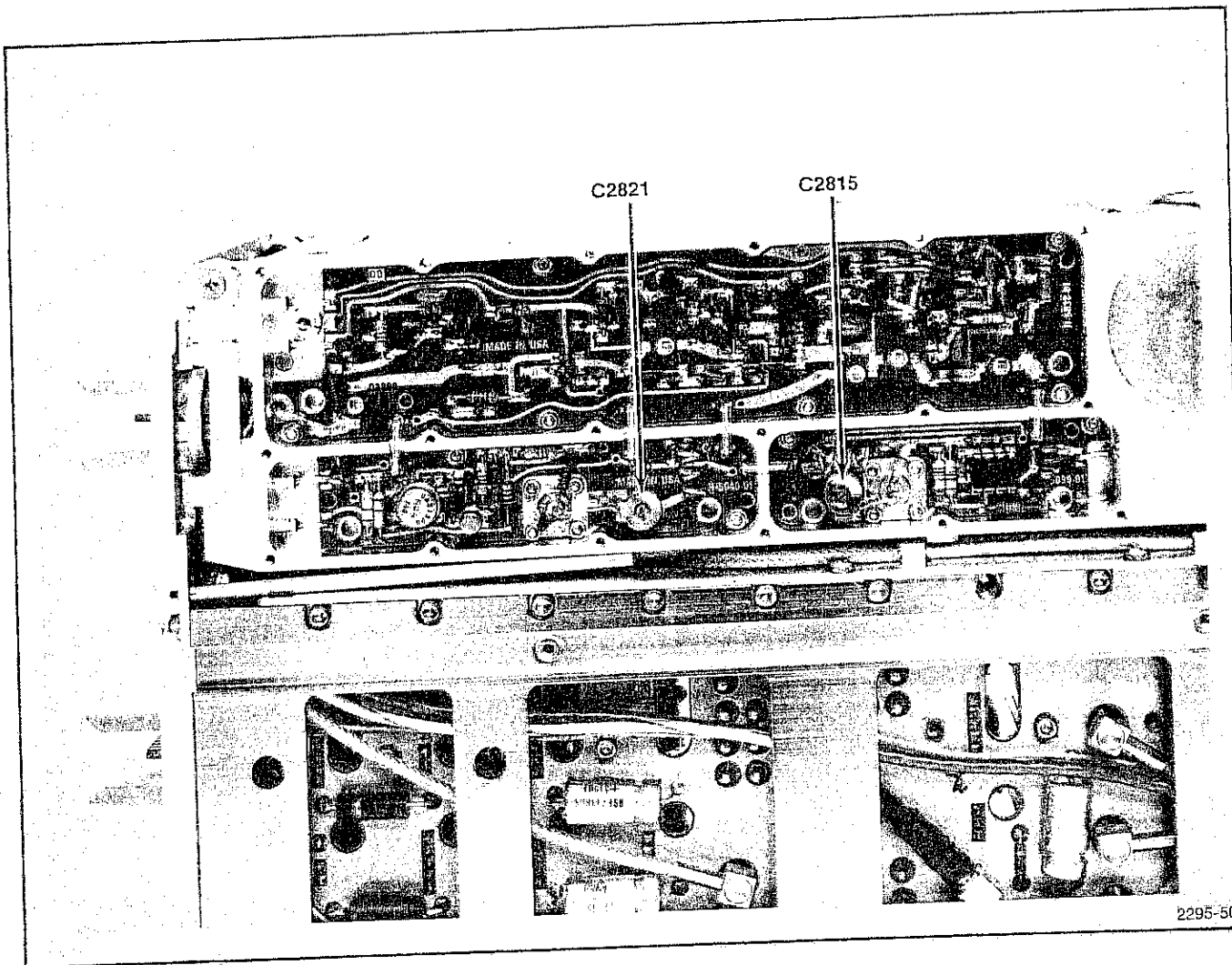

Fig. 4-42. Location of C2821 and C2815.

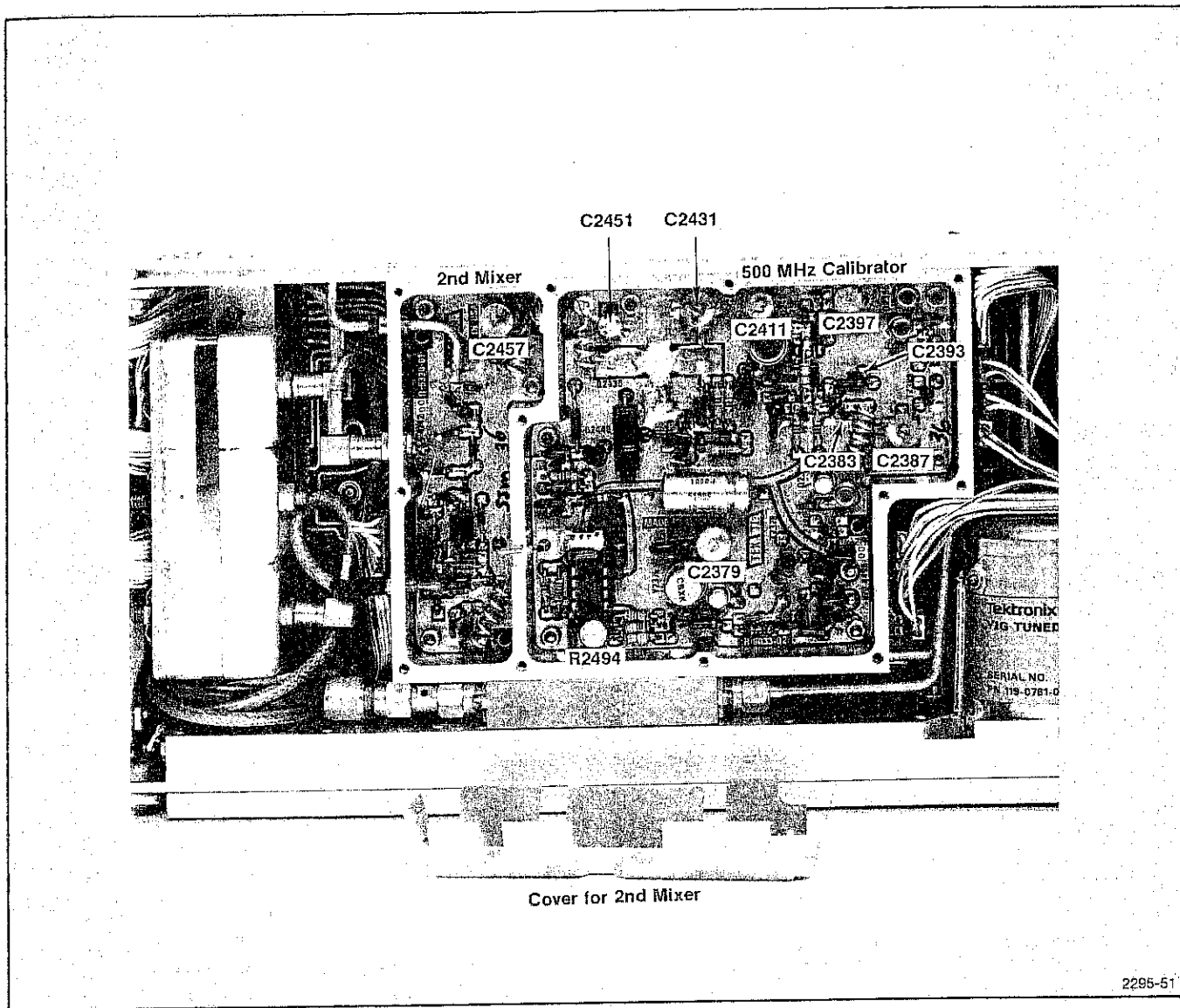

Fig. 4-43. 500 MHz Calibrator and 2nd Mixer Adjustment and T.P. Locations.

2295-51

Calibration—7L18 Interim Service

b. Turn Power on. Use a voltmeter or test oscilloscope voltage probe to measure the voltage across C2383, and adjust C2379 for a voltage dip (see Fig. 4-43). The voltage value at the dip can be expected to be approximately 13.8 volts.

c. Measure the voltage across C2393 as C2387 is adjusted for a voltage dip. The voltage at the dip can be expected to be approximately 13.8 volts. Adjust R2494 ccw.

d. Apply the CAL OUT signal to the RF INPUT of the 7L18 or to a test spectrum analyzer and tune one of the 500 MHz markers to center screen.

e. Adjust the remaining trimmer capacitors (C2397, C2431, C2451, C2457, and C2411) for maximum signal amplitude (see Fig. 4-43).

f. Replace the shield and cover, tune the test spectrum analyzer to 2.0 GHz, and note the output level of the CAL OUT signal. Adjust R2494 for an indicated -30 dBm output.

g. Now use the procedure described in the Performance Check part to measure the calibration output (refer to step 2), calibrate the output to an accurate -30 dBm, 2.0 GHz with R2494.

9. Calibration of Digital Storage

a. Apply the CAL OUT signal to the RF Input and set the front panel controls as follows:

Display Mode	LOG 10 dB/DIV
Band Selection	1.5—3.5
CENTER FREQUENCY	2.5 GHz
TIME/DIV	AUTO
RESOLUTION BANDWIDTH	AUTO
FREQ SPAN/DIV	200 MHz
BASELINE CLIPPER	Fully cw

b. Tune the 2.5 GHz calibrator signal to center screen so the display covers the 1.5 to 3.5 GHz span. Activate and de-activate DISPLAY A and adjust Horiz Offset R3507 (see Fig. 4-44) until the stored 2.5 GHz signal is at the same horizontal point as the non-stored display.

d. Repeat as necessary to compensate for any interaction between the Horiz Offset and Horiz Gain adjustments.

e. Change the REFERENCE LEVEL to -20 dBm, switch to the non-store mode and tune the 2.0 GHz signal to center screen. Reduce the SPAN/DIV to 100 kHz, switch the RESOLUTION BANDWIDTH to 300 kHz, and the Display Mode to 2 dB/DIV.

f. Adjust PEAKING for maximum signal amplitude. Signal amplitude should be about three divisions.

g. Activate and de-activate DISPLAY A as the Vert Offset is adjusted with R3519, (see Fig. 4-44) until the stored signal amplitude is the same as the non-store amplitude.

h. Return the REFERENCE LEVEL to -30 dBm and with DISPLAY A de-activated (storage off), note the amplitude of the signal (approximately eight divisions).

i. Activate and de-activate DISPLAY A as the Vert Gain is adjusted with R3510, (see Fig. 4-44) so the stored display amplitude equals the non-store display.

j. Because of interaction, these two adjustments should be repeated until the stored display is calibrated to that of the non-store display.

10. Setting the Constant "K" for the Zero Reference of the B-SAVE A Display

When B-SAVE A is selected, the expression implemented is $(B-SAVE A)-k$, where "K" is a constant set by the input data for an 8 to 4 line encoder, U3566. Each bit will move the reference level about 0.2 of a minor division. The following procedure sets the value of "K" to move the B-SAVE A reference level.

a. Estimate the amount of shift and direction the reference level is to be shifted.

b. Turn the POWER off and remove the Digital Storage module.

NOTE

Refer to the Adjustment or Component Access instructions at the beginning of this part.

c. Separate the Digital Storage board from the Interface board. Pull the boards apart from their interconnecting pins evenly so the pins are not bent.

d. Connect or disconnect resistors R3561 through R3568 (see Fig. 4-45) to acquire the desired "K" factor or reference level.

e. Replace circuit boards and check operation.

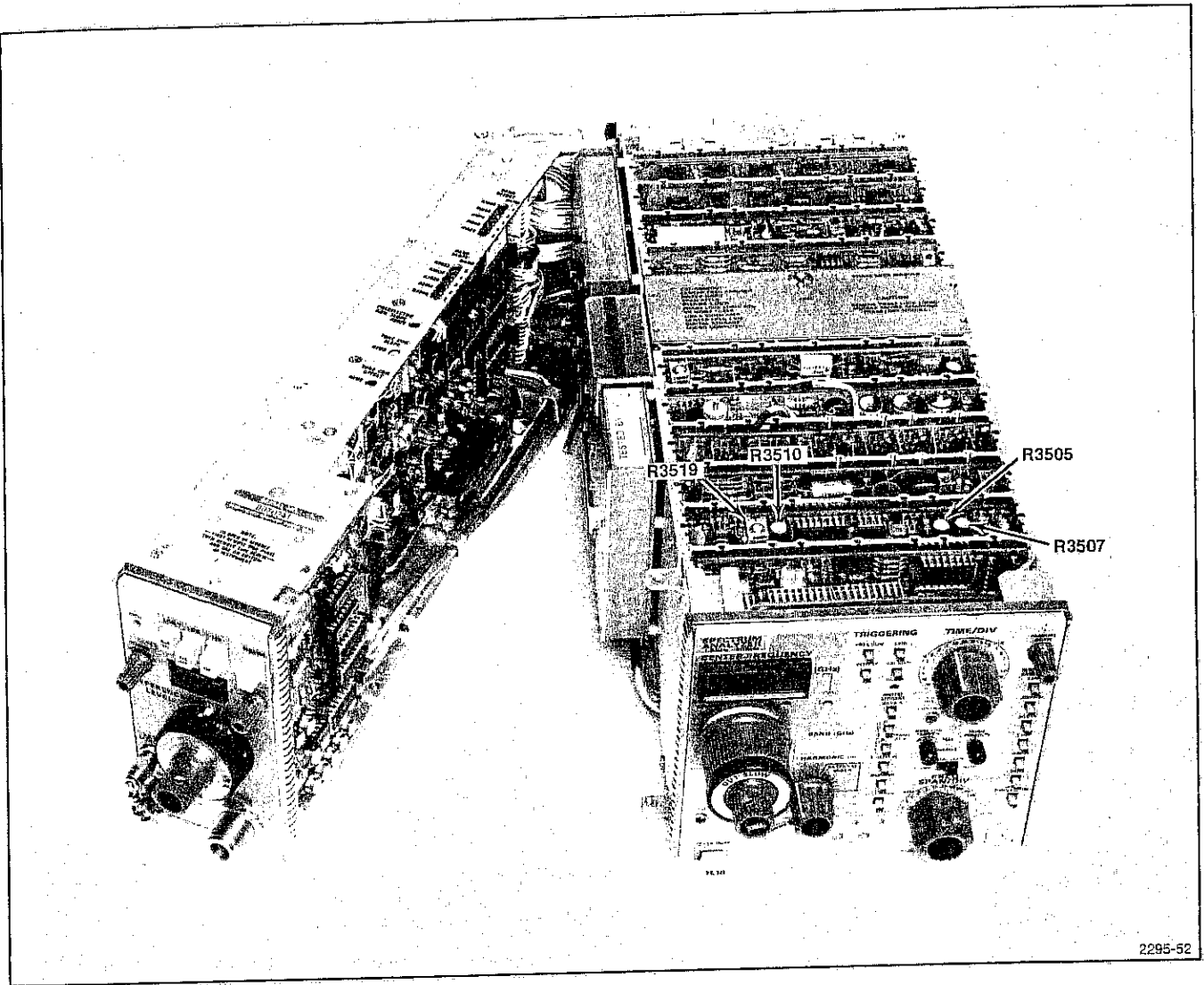

Fig. 4-44. Digital Storage Calibration Adjustments.

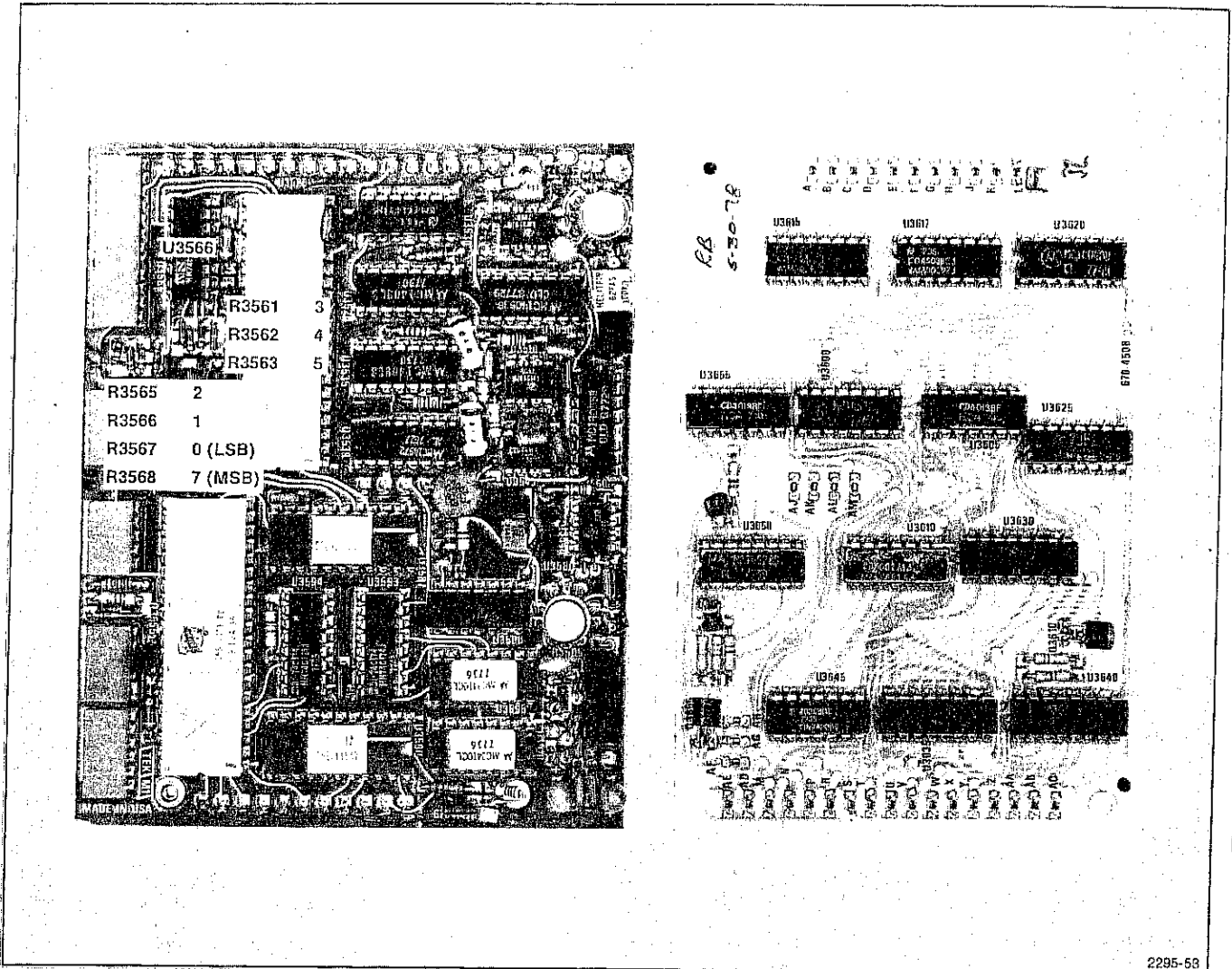

Fig. 4-45. Location of B-SAVE A Reference Level Positioning Resistor Matrix.

11. Calibration of the Resolution Bandwidth and Shape Factor

a. Set the front panel controls as follows:

CENTER FREQUENCY	2.0 GHz
FREQ SPAN/DIV	5 MHz
RESOLUTION	300 kHz
Vertical Mode	2 dB/DIV
REFERENCE LEVEL	-30 dBm
TIME/DIV	20 ms
DIGITAL STORAGE	DISPLAY A/DISPLAY B
PHASE LOCK	AUTO

b. Apply the CAL OUT signal to the RFINPUT and tune the Calibrator signal to center screen, then decrease the SPAN/DIV to 50 kHz, RESOLUTION BANDWIDTH to 30 kHz.

c. Tune the signal to center screen to establish filter center, then increase the RESOLUTION BANDWIDTH to 300 kHz.

NOTE

If the 3 MHz filter is out of calibration, a satisfactory display of the 300 kHz filter may not be possible. If this is the case, adjust the 3 MHz filter and then proceed with the 300 kHz filter adjustments.

d. Adjust the 300 kHz filter and the 300 kHz Noise Filter with C3190, C3195, C3200, C3425, C3436, and C3446 (see Fig. 4-46) for the best amplitude, symmetry, and shape around the 3 kHz reference center frequency.

e. Change the SPAN/DIV to 1 MHz and tune the signal to center screen with a RESOLUTION BANDWIDTH of 30 kHz.

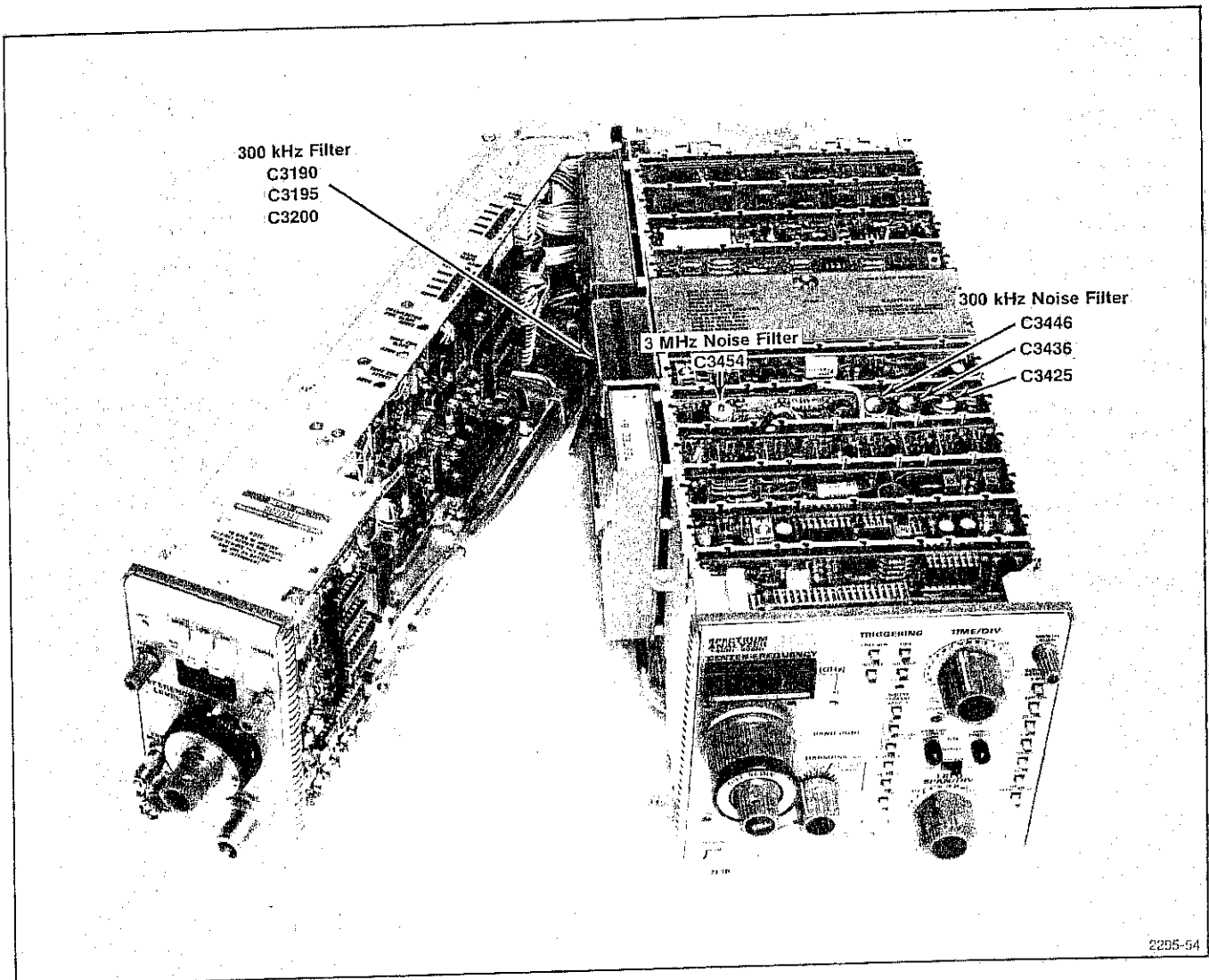

Fig. 4-46. Adjustments for 300 kHz Filter, 300 kHz Noise Filter, and 3 MHz Noise Filter.

f. Change the RESOLUTION BANDWIDTH to 3 MHz, then adjust the three cavity filter (see Fig. 4-47) with a 7/64" Allen drive wrench, and the 3 MHz Noise Filter with C3454 (see Fig. 4-45) for the best amplitude, symmetry, and shape around the 30 kHz reference center frequency.

g. Re-adjust filter amplitude levels, using 30 Hz filter amplitude as the reference. Refer to Step 6 for this procedure.

h. Check all filters for characteristic bandwidth $\pm 20\%$.

i. Check 3 MHz, 300 kHz, 30 kHz, 3 kHz, and 300 Hz for a shape factor of 4:1 or better (refer to Performance Check portion of this procedure). Check 30 Hz filter for shape factor of 12:1 or better.

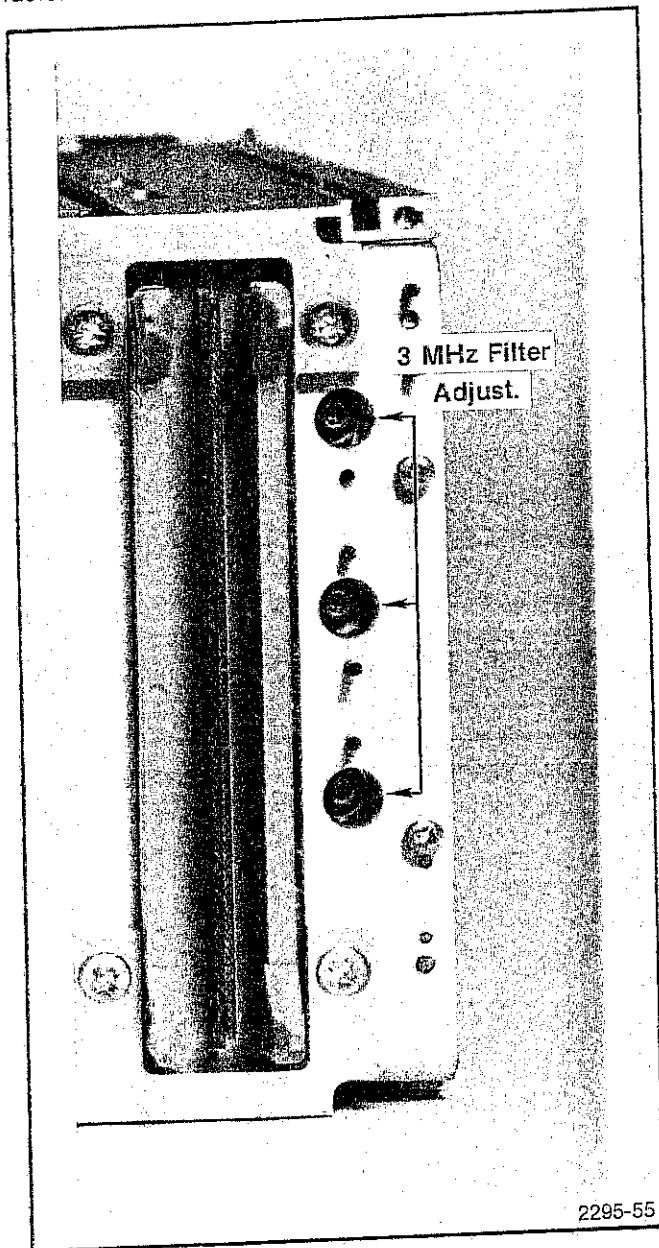

Fig. 4-47. Location of 3 MHz, Three-Section Filter Adjustments.

12. Input compression Check (≥ -22 dBm, 1.5—1.8 GHz; ≥ -18 dBm, 1.8—18 GHz)

a. Apply the CAL OUT signal to the RF INPUT and set the front panel controls as follows:

CENTER FREQUENCY	2.0 GHz
Vertical Display	2 dB/DIV
FREQ SPAN/DIV	2 MHz
RESOLUTION BANDWIDTH	3 MHz
RF ATTEN	0 dB
REFERENCE LEVEL	-30 dBm
TIME/DIV	AUTO

b. Tune the calibrator signal to center screen, peak the signal amplitude with the PEAKING control, then adjust the AMPLITUDE CAL for a signal amplitude of six divisions.

c. Change the REFERENCE LEVEL to -20 dBm and note the reference amplitude.

d. Remove the CAL signal to the RF INPUT and apply a -30 dBm, 2 GHz signal from a UHF signal generator to the RF INPUT.

e. Adjust the signal generator level until the 2.0 GHz signal is the same amplitude as the reference, established in part c of this step.

f. Increase the signal generator output until the signal compresses 1 dB (e.g., a -18 dBm signal display reduces to -19 dBm). Signal compression point must not occur before -18 dBm.

g. Use the signal generator as a 1.5 GHz signal source to establish the reference, then use the above procedure to determine the 1 dB compression point at 1.5 GHz. Signal compression must not occur before -22 dBm.

13. Adjustment of the Preselector Offset

a. On the 1st LO and Preselector Driver board, remove Q2070, connect a shorting strap across TP2060 and TP2065, and connect a voltmeter or dc coupled test oscilloscope probe between connector P and ground (see Fig. 4-48).

b. Set the 7L18 FREQUENCY RANGE to Band 6 (12.5 to 24.5 GHz).

c. Adjust the PEAKING control for zero volt between point P and ground.

d. Connect the voltmeter or test scope probe across TP2065 and Pin J. Adjust R2066 for zero volt between TP2065 and Pin J.

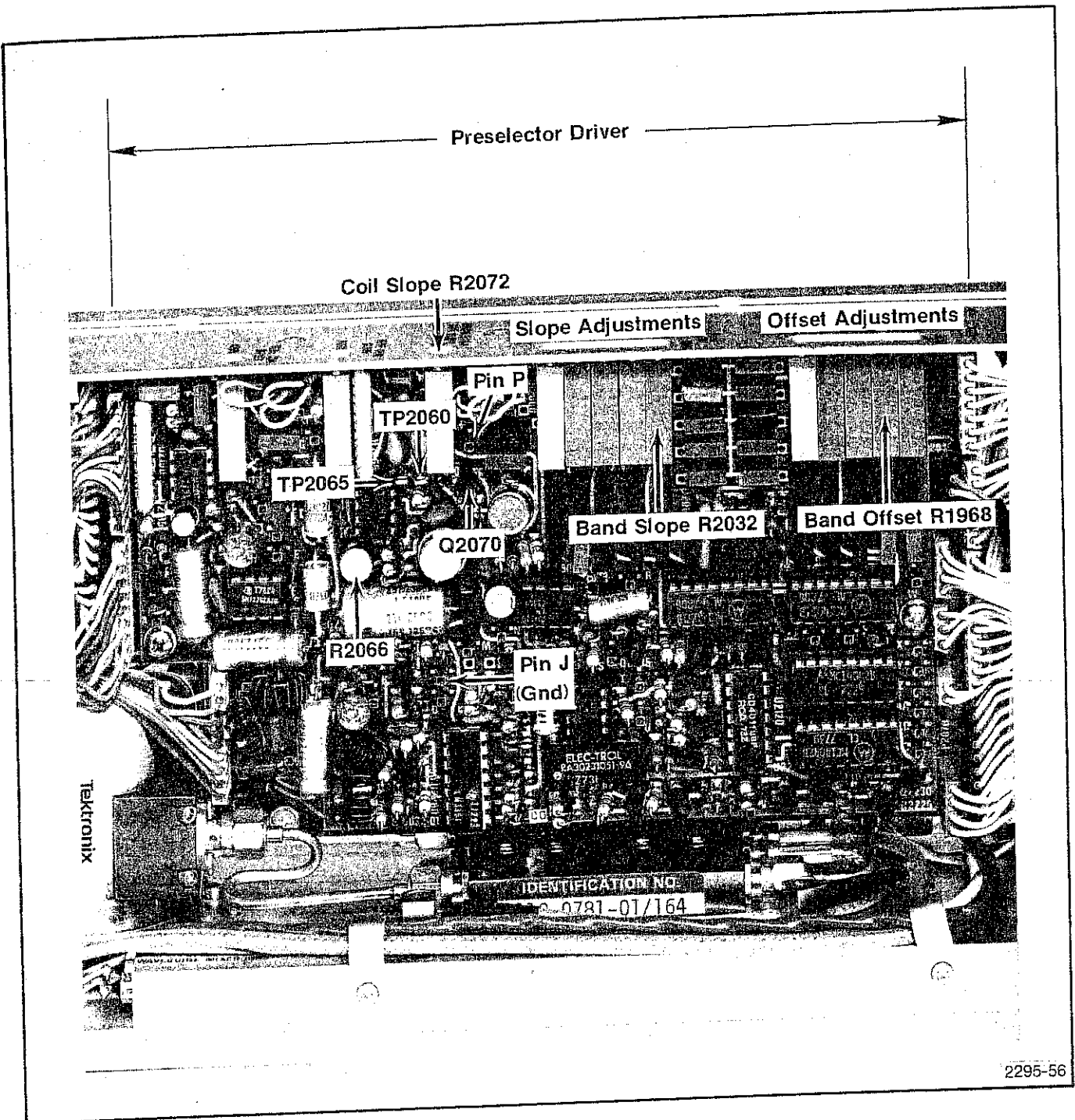

Fig. 4-48. Preselector Driver Adjustment and T.P. Locations.

NOTE

This adjustment will be in the millivolt range; use the appropriate scale.

- e. Remove the shorting strap and replace Q2070.

14. Adjust Preselector Tracking and Flatness

This two part procedure consists of preliminary and final adjustments. In most cases the preliminary adjustments are required only if the YIG preselector is replaced; otherwise, only the final (beginning with part m) adjustments are required.

Preliminary

a. Set the front panel controls as follows:

Vertical Mode	10 dB/DIV
TIME/DIV	AUTO
RESOLUTION BANDWIDTH	AUTO
RF Attenuation	40 dB
FREQ SPAN/DIV	MAX
BAND	5 (9.5—18.0 GHz)

b. Adjust the PEAKING control for +7.5 volts at its center tap (midrange).

c. Set the following Preselector Driver and Vertical Microcomputer Interface adjustments to midrange (see Figs. 4-48 and 4-49).

Band 1 through 5 Offset adjustment—R1962, R1970, R1976, R1980 and R1986 (Fig. 4-48). Band 1 through 5 Slope adjustments—R2008, R2014, R2020, R2026, and

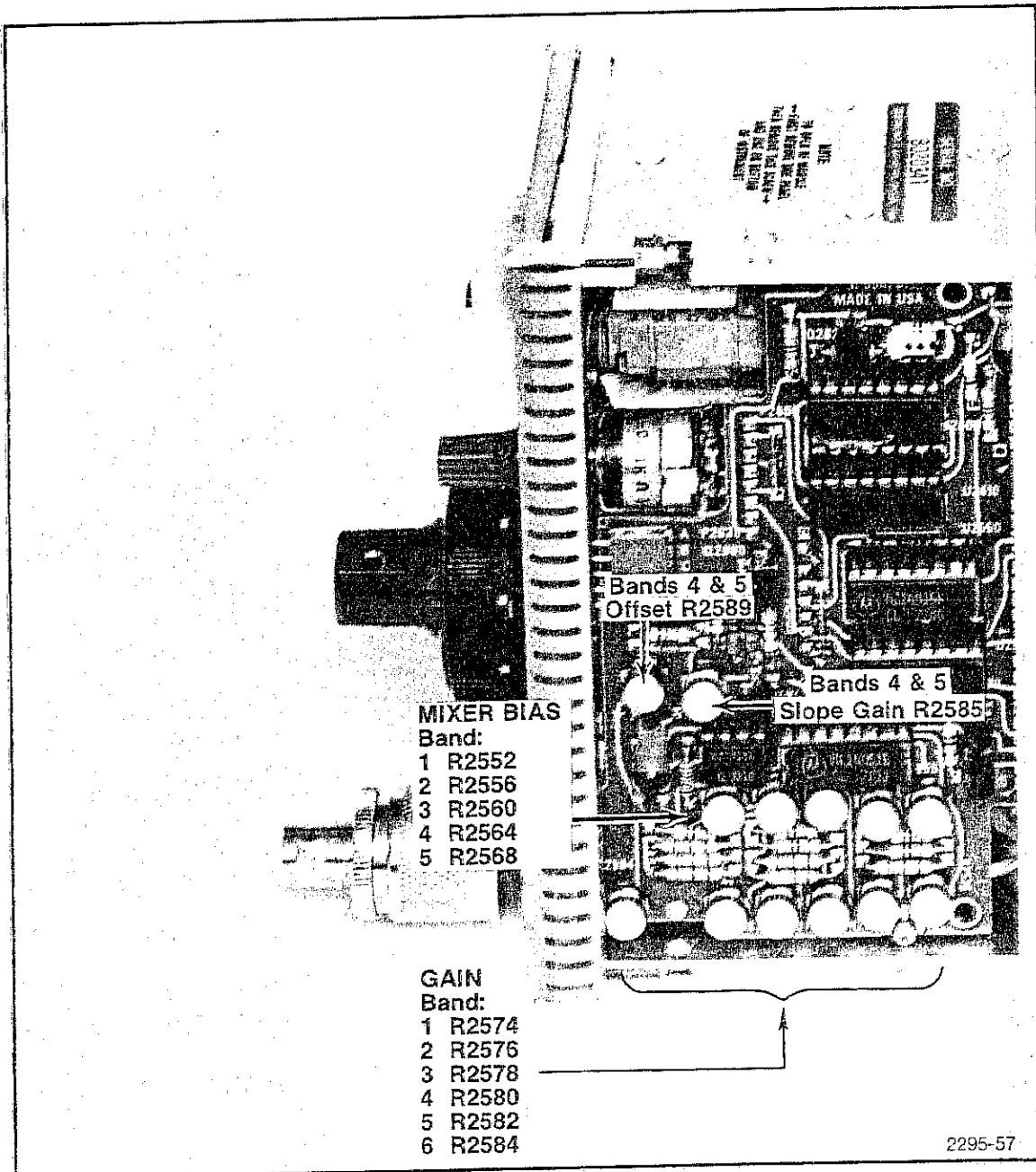

Fig. 4-49. Vertical Microcomputer Interface Adjustment and T.P. Locations.

R2032 (Fig. 4-48). Band 1 through 6 Gain adjustments—R2574, R2576, R2578, R2580, R2582, and R2584 (Fig. 4-49). Mixer Bias adjustments—R2560 and R2568 (see Fig. 4-49).

d. Set the following adjustments fully counterclockwise (see Fig. 4-49):

Band 1, 2, and 4 mixer Bias—R2552, R2556, and R2564.

e. Set the RF Attenuator to 10 dB. Connect the output of a Comb Generator (e.g., 067-0885-00) to the RF INPUT. (Ensure that the RF Attenuator is set for 40 dB of attenuation.) The output pulses of the Comb Generator should appear as a comb of 500 MHz markers on the display.

f. Adjust Preselector Coil Slope R2072 (see Fig. 4-48) to center the comb of markers on the display.

g. Change BAND selector to 2 (2.5 to 4.5 GHz) and adjust Band Offset R1968 (see Fig. 4-48) to center the comb envelope on the display.

NOTE

If an adjustment range is limited to the extent that the comb envelope cannot be centered, readjust Coil Slope R2072 and repeat the adjustment step. If this procedure is unsuccessful, it may be necessary to add correction resistors to change the adjustment range of the Slope and Offset adjustments for Bands 1 through 5. Suggested correction values for each adjustment are listed in Table 4-9. If an adjustment range is limited in the clockwise direction, add a series resistor to increase the voltage. If the range is limited in the counterclockwise direction, add a parallel resistor. The resistance values listed in Table 4-9 were chosen to provide for an adjustment range increase of 50% or 100%. If some other percentage of adjustment range increase is desired, add a resistor of the appropriate value.

The Preselector Driver board has two rows of pads (see Fig. 4-50) that are to be used when installing correction resistors. The row of pads labeled SER, for series, have shorting straps located on the back side of the board. These straps must be removed before the resistor is installed. The row of pads labeled PAR, for parallel, does not have shorting straps.

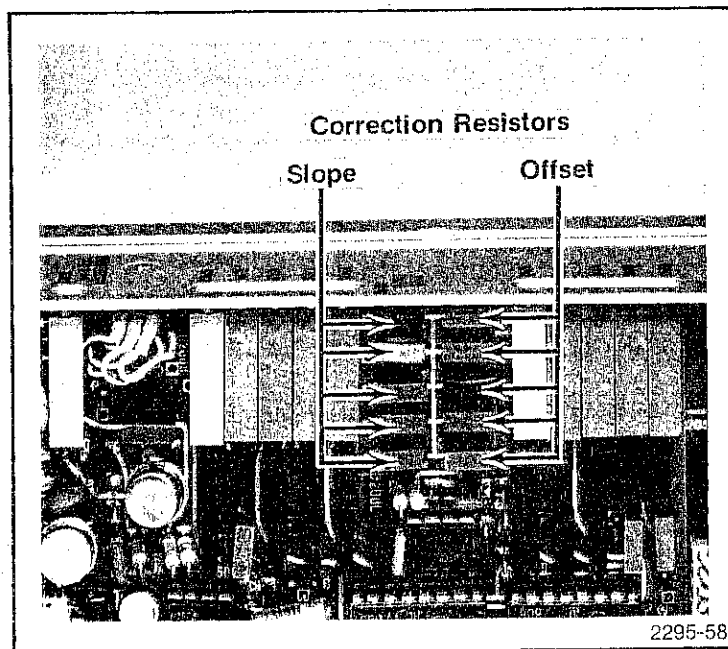

Fig. 4-50. Location of Preselector Driver Slope and Offset Correction Resistors Listed in Table 4-7.

Table 4-9

Control	Fixed Resistor	Series cw Limited		Parallel ccw Limited	
		50%	100%	50%	100%
Band 1 Offset	R1992	1.291K	2.32K	330K	162K
Band 2 Offset	R1994	931	1.87K	249K	111K
Band 3 Offset	R1996	590	1.15K	150K	72.3K
Band 4 Offset	R1998	335.6	650.4	90K	42K
Band 5 Offset	R2000	250	455	61.73K	27.4K
Band 1 Slope	R2038	3.04K	6.04K	731.3K	400K
Band 2 Slope	R2040	3.04K	6.04K	731.3K	400K
Band 3 Slope	R2042	1.56K	3.04K	400K	187K
Band 4 Slope	R2044	1K	2K	277.8K	121K
Band 5 Slope	R2046	650.4	1.24K	162K	72.3K

NOTE

Part numbers for resistors with the suggested values are listed in Table 4-10. If a resistor is used that is not listed, observe the tolerance and temperature requirements for the suggested resistor.

Table 4-10

Tektronix Part Numbers and Tolerance Values for Corrective Resistors

Value			Part Number
250	0.1%	T9	321-0928-07
335.6	0.1%	T9	321-0814-07
455	0.1%	T9	321-0812-07
590	1%	T9	321-0171-09
650.4	0.25%	T9	321-0650-00
931	1%	T9	321-0190-09
1.00K	0.1%	T9	321-0193-07
1.15K	0.25%	T9	321-0199-06
1.24K	1%	T9	321-0202-09
1.291K	0.1%	T9	321-0915-07
1.56K	1%	T9	321-1211-09
1.87K	1%	T9	321-0219-09
2.0K	1%	T9	321-0222-09
2.32K	1%	T9	321-0228-09
3.04K	0.1%	T9	321-0666-07
6.04K	1%	T9	321-0268-09
27.4K	1%	T9	321-0331-09
42K	0.25%	T9	321-0820-06
61.73K	0.25%	T9	321-1622-06
72.3K	0.25%	T9	321-1642-06
90K	0.1%	T9	321-0993-07

Table 4-10 (cont)

Value			Part Number
111K	0.1%	T9	321-1389-07
121K	1%	T9	321-0393-09
150K	1%	T9	321-0402-09
162K	1%	T9	321-0405-09
187K	0.25%	T9	321-0701-00
249K	1%	T9	321-0423-09
277.8K	0.25%	T9	321-1625-06
330K	0.1%	T9	321-0856-07
400K	0.25%	T9	321-0781-06
731.3K	0.25%	T9	321-1627-06

h. Set Band selector to 5 and adjust Band 5 Slope R2032 to equalize the amplitude of the high and low segments of the comb. Select that combination of Band 5 Slope and Band 5 Offset adjustments to produce a maximum peak value for the comb line display. If the Slope is adjusted properly, adjusting the Offset should affect the amplitude and direction of all comb markers equally.

i. Adjust Band 5 Bias R2568 (see Fig. 4-49) for overall flatness of the comb display. Use the RF Attenuator, if needed, to avoid over-driving the preselector.

j. Switch to Band 4 (6.5 to 12.5 GHz) and adjust Band 4 Offset R1980 (Fig. 4-48) and Bias R2564 (Fig. 4-49) for maximum comb amplitude and flatness. Use the same procedure as that described for Band 5.

k. Using the foregoing procedure, adjust Bands 3, 2, and 1 Offset, Slope, and Bias for the best tracking and flatness on each band.

l. Disconnect the Comb Generator from the RF INPUT and return the RF Attenuator setting to 10 dB.

FINAL

m. Apply a -30 dBm signal from a leveled sweep generator with an output power meter to the 7L18 input mixer. If the generator output level is too high (e.g., 0 dBm minimum), use an external attenuator or add appropriate attenuation with the 7L18 RF Attenuator.

NOTE

If an external attenuator is used, ensure that its frequency specifications exceed 18 GHz. The PEAKING control should still be centered (+7.5 V at its center terminal) as directed in part b.

n. Set the 7L18 and signal generator controls as follows:

7L18

FREQ SPAN/DIV	MAX
RESOLUTION BANDWIDTH	AUTO
TIME/DIV	AUTO
BAND	9.5 to 18 GHz (5)
RF Attenuation	10 dB above setting for part m of this step
REFERENCE LEVEL	-20 dBm
Display Mode	2 dB/DIV
Digital Storage	DISPLAY A/DISPLAY B

Sweep Generator

Trigger	Int or Single
Time	100 s or slower
Sweep Function	Auto
Start Marker	9.5 GHz
Stop Marker	18.0 GHz
Power Level	0 dBm or lower

o. Position adjustments R2047 (Preselector Peaking) and R2589 (Band Offset) to midrange (Figs. 4-48 and 4-49). Set the amplitude of the sweep generator display to midscreen with the REF VAR control. Observe the stored display after one full sweep.

p. Adjust R2043 (Band 5 Slope) R1986 (Offset), and R2568 (Mixer Bias), for best overall flatness. If flatness rolls off at the high end, adjust the overall Slope Gain with R2585 (Fig. 4-49). R2585 also affects Band 4 flatness. Slope adjustment R2032 (Fig. 4-48) affects the gain slope or the high end of the frequency range. Mixer bias should be adjusted for best sensitivity at the high end and Offset adjustment R1968 should shift the overall response about the center of the span.

q. Adjust preselector peaking with R2042 (see Fig. 4-48) for maximum response at the high end of Band 5. This calibrates the position of the front panel PEAKING control at midrange.

r. Change the sweep generator span to sweep from 6.5 to 12.5 GHz and the 7L18 to Band 4 (6.5 to 12.5 GHz). Note the flatness.

s. Adjust Band 4 Slope R2026, Offset R1980 (Fig. 4-48), and Mixer Bias R2564 (Fig. 4-49), for the best overall flatness using the procedure outlined in p of this step. Since R2585 and R2589 affect flatness for both Bands 4 and 5, it may be necessary to set these for the best compromise between the two.

t. Set the 7L18 Band to 3 and the sweep generator to sweep from 3.5 to 7.5 GHz. Note the flatness.

u. Adjust Band 3 Slope R2020, Offset R2026, and Mixer Bias R2560, for best overall flatness.

v. Change the 7L18 frequency range to Band 2 and the sweep generator to sweep from 2.5 to 4.5 GHz. Note the flatness.

w. Adjust Band 2 Slope R2014, Offset R1968, and Mixer Bias R2556 (Figs. 4-48 and 4-49), for best overall flatness.

x. Set the 7L18 frequency range to Band 1 and change the sweep generator frequency to sweep from 1.5 to 3.5 GHz. Check the flatness.

NOTE

It may be necessary to change sweep generators to cover the frequency span of Band 1.

y. Adjust Band 1 Slope R2008, Offset R1962, and Mixer Bias R2582, for best flatness.

NOTE

Flatness is not specified but is typically ± 1 dB worse than the frequency response. Frequency response is determined for each band with the PEAKING control adjusted to maximize the response. Frequency response is ± 5 dB from 1.5 to 18.0 GHz.

15. Calibrate the Gain for Coaxial Bands 1 through 5**NOTE**

The mean value of the flatness response for all bands is set to a -30 dBm, 2.0 GHz reference.

a. Set the front panel controls as follows:

CENTER FREQUENCY	2.0 GHz
BAND Selection	1.5 to 3.5 GHz (1)
Display Mode	2 dB/DIV
RF Attenuation	10 dB
REFERENCE LEVEL	-20 dBm
FREQ SPAN/DIV	MAX
RESOLUTION BANDWIDTH	AUTO
TIME/DIV	AUTO
Digital Storage	Display A/Display B

b. Preset Band 1 Gain R2574 (see Fig. 4-48) approximately 10% above its fully ccw position.

c. Apply a calibrated -30 dBm, 2.0 GHz reference signal to the RF INPUT. Use the 7L18 Calibrator signal if accuracy has been verified; or, measure the output of the sweep generator at 2.0 GHz with an accurate power meter. Measure at the cable end of the output to ensure -30 dBm level into the 7L18 RF INPUT.

d. Adjust the PEAKING control for maximum signal amplitude; then set the signal peak at the -30 dBm graticule reference line with the front panel AMPLITUDE adjustment (five divisions below the reference, top, graticule line with -20 dBm REFERENCE LEVEL).

e. Remove the -30 dBm calibrated source if the Calibrator was used; then apply the output of a power leveled sweep generator to the RF INPUT. Set the frequency to 2.0 GHz and the output to the -30 dBm reference established in part d of this step.

f. Set the 7L18 BAND selector to Band 2 (2.5 to 4.5 GHz), and set the generator for a sweep from 2.5 to 4.5 GHz.

g. Adjust the Band 2 Gain R2576 (see Fig. 4-49) so the mean average level of the display is at the -30 dBm reference.

h. Change the 7L18 BAND selector to Band 3 (3.5 to 7.5 GHz) and the sweep generator for a sweep from 3.5 to 7.5 GHz.

i. Adjust Band 3 Gain R2578 (see Fig. 4-49) so the mean level (arithmetic average between maximum and minimum excursions) of the display is at the -30 dBm reference.

j. Change the BAND selector to Band 4 (6.5 to 12.5 GHz) and the sweep generator for a sweep that covers Band 4.

k. Adjust Band 4 Gain R2580 (Fig. 4-49) so the mean (average) level of the display is at the -30 dBm reference.

l. Set the 7L18 BAND selector to 5 (9.5 to 18.0 GHz) and the sweep generator for a sweep that covers Band 5.

m. Adjust Band 5 Gain R2582 (Fig. 4-49) so the display mean amplitude level is at the -30 dBm reference.

n. Disconnect and remove the test equipment setup.

16. Calibrate the Gain of the Waveguide Bands (6 through 10)

a. Set the 7L18 BAND selector to Band 6 (12.5 to 24.5 GHz), the RF Attenuator at 0 dB, and the REFERENCE LEVEL for -30 dBm. Set FREQ SPAN/DIV to 200 MHz, RESOLUTION BANDWIDTH and TIME/DIV to AUTO.

b. Apply a calibrated -60 dBm, 510 MHz signal from a UHF signal generator, through a dc blocking capacitor (e.g., Tektronix Part No. 015-0021-00) to the EXT MIXER input of the 7L18 (see Fig. 4-51).

NOTE

The baseline of the display will rise when the 510 MHz signal is applied to the EXT MIXER input port.

c. Adjust waveguide band Gain R2584 (see Fig. 4-49) so the display amplitude is at the -30 dBm reference established in step 15.

d. Return the BAND selector to 1 (1.5 to 3.5 GHz); disconnect the signal generator from the MIXER INPUT and reconnect the 50 ohm termination to the EXT MIXER bias port.

This concludes the adjustment part of the Calibration Procedure. After performing any adjustment procedure recheck the 7L18 performance to ensure it is operating within specifications.

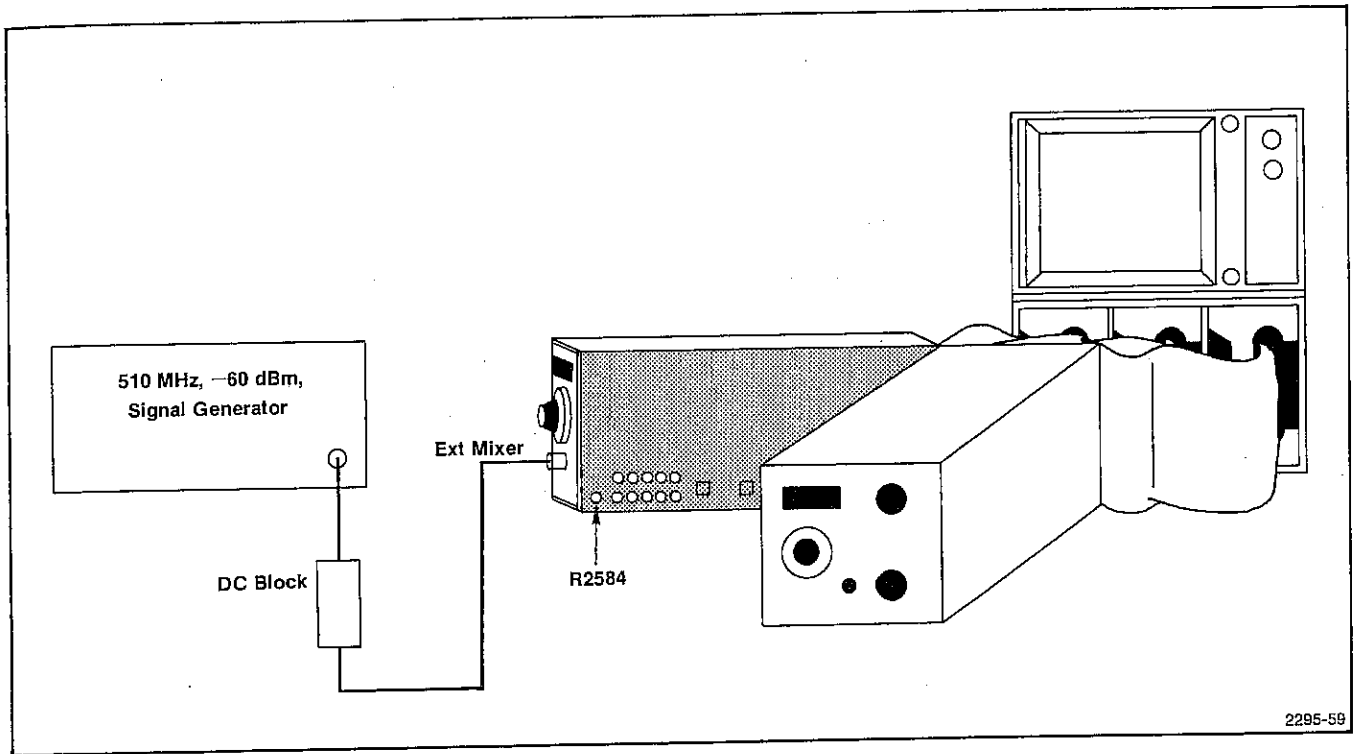

Fig. 4-51. Test Setup for Calibrating Gain of the Waveguide Bands.

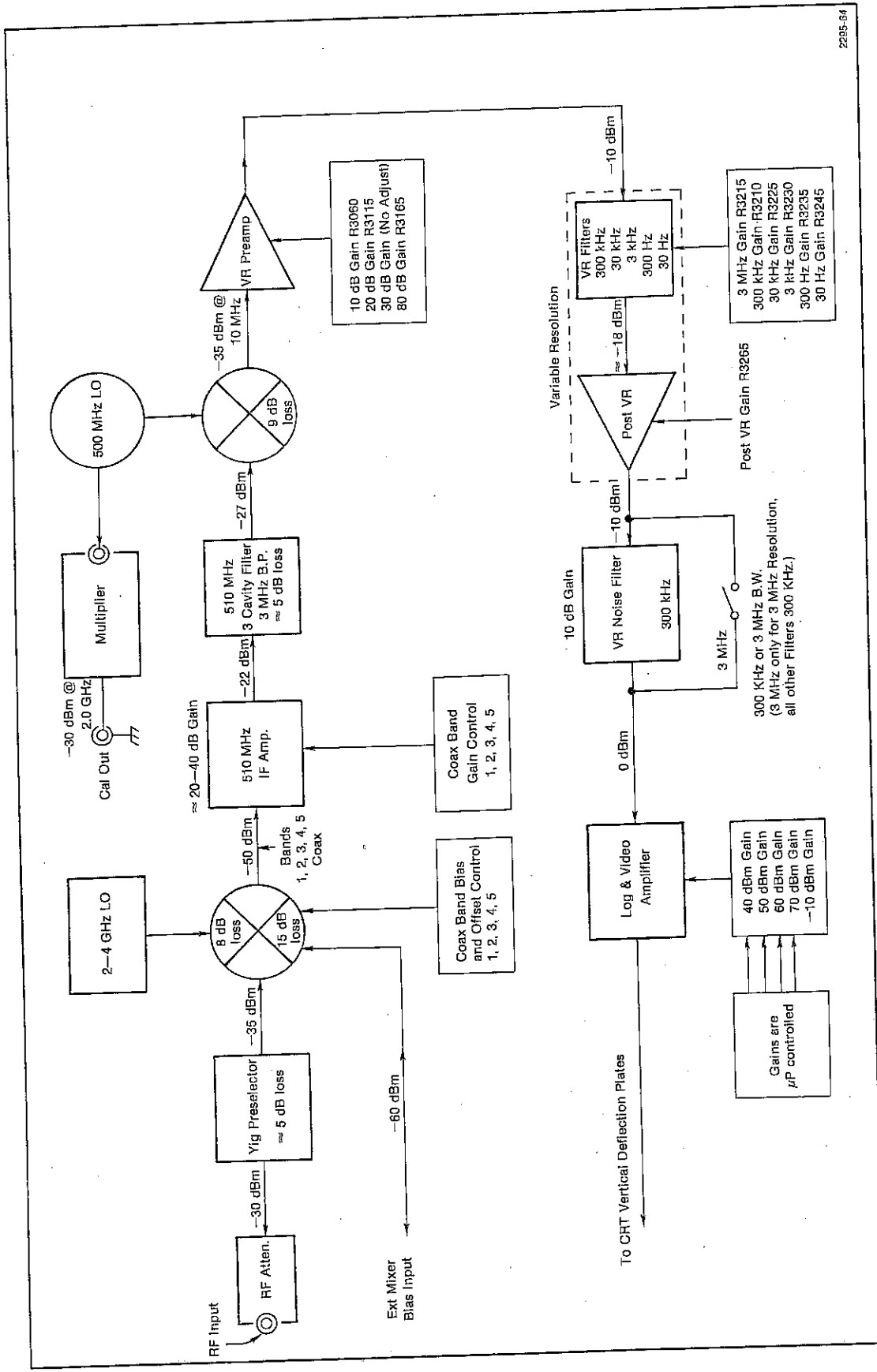

Fig. 4-52. Typical signal levels of the signal path through the 7L18.