

Reference
Référence
Referenz
Referencia

Tektronix

TDS 340, TDS 360 & TDS 380
Digital Real-Time Oscilloscopes
Oscilloscopes numérique à temps réel
Digitale Echtzeit-Oszilloskope
Osciloscopios digitales de tiempo real

070-9434-00

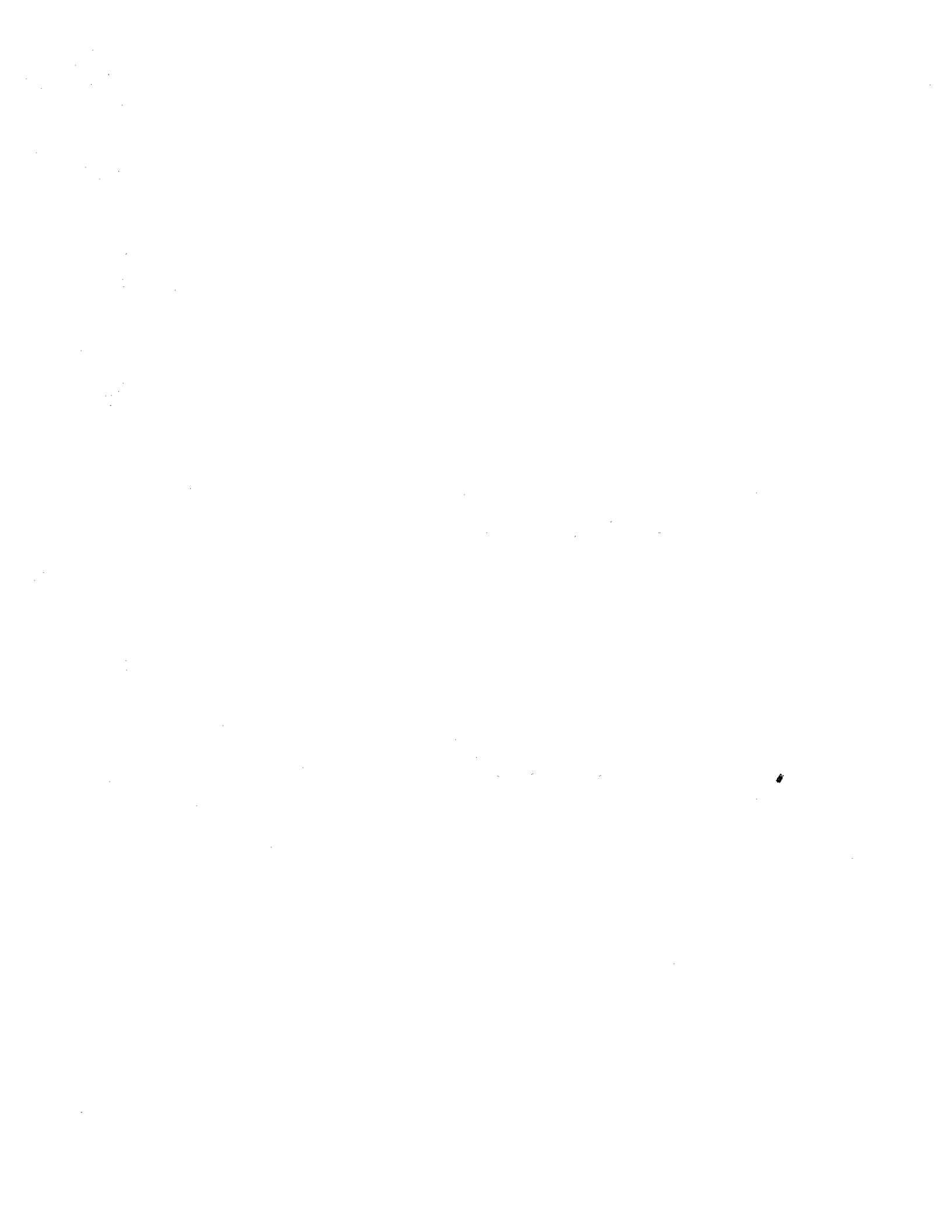

Operating a Menu

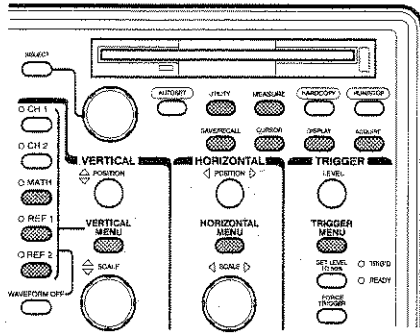

1. Press any of the front-panel menu buttons.

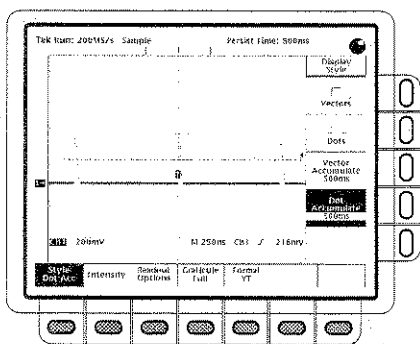

2. Select an item from the main (bottom) menu.

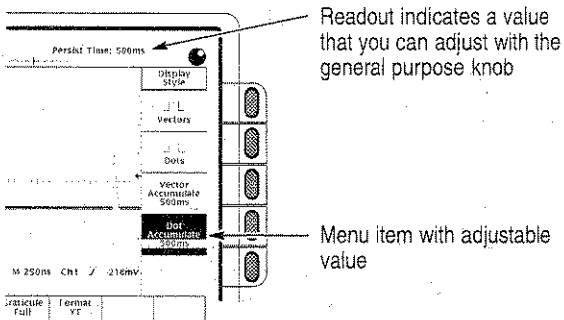

3. If displayed, select an item from the side menu.

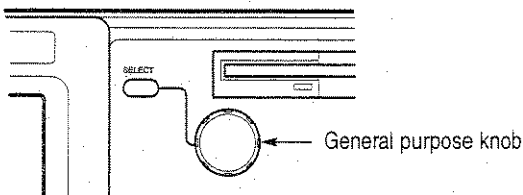

4. Adjust menu-item values with general purpose knob.

Controls

Cursor Control

SELECT switches the general purpose knob assignment between the displayed measurement cursors.

General Purpose Knob

Depending on the last menu selected, the general purpose knob controls various operations.

Miscellaneous Controls

AUTOSET automatically adjusts instrument controls to obtain a usable display.

UTILITY displays the configure, I/O, system calibration, and diagnostic menus.

SAVE/RECALL displays the menu for saving and recalling waveforms and front-panel setups. Also, use SAVE/RECALL to access the floppy disk file utilities.

MEASURE displays the automated-measurement menu.

CURSOR displays the menu choices for the cursor modes.

HARDCOPY starts hard copy operations.

DISPLAY displays the menu for altering display parameters.

Acquisition Controls

RUN/STOP starts and stops acquisition.

ACQUIRE displays the acquisition control menu.

Menu Controls

The menu controls operate as described under *Operating a Menu*.

CLEAR MENU clears most menus from the CRT.

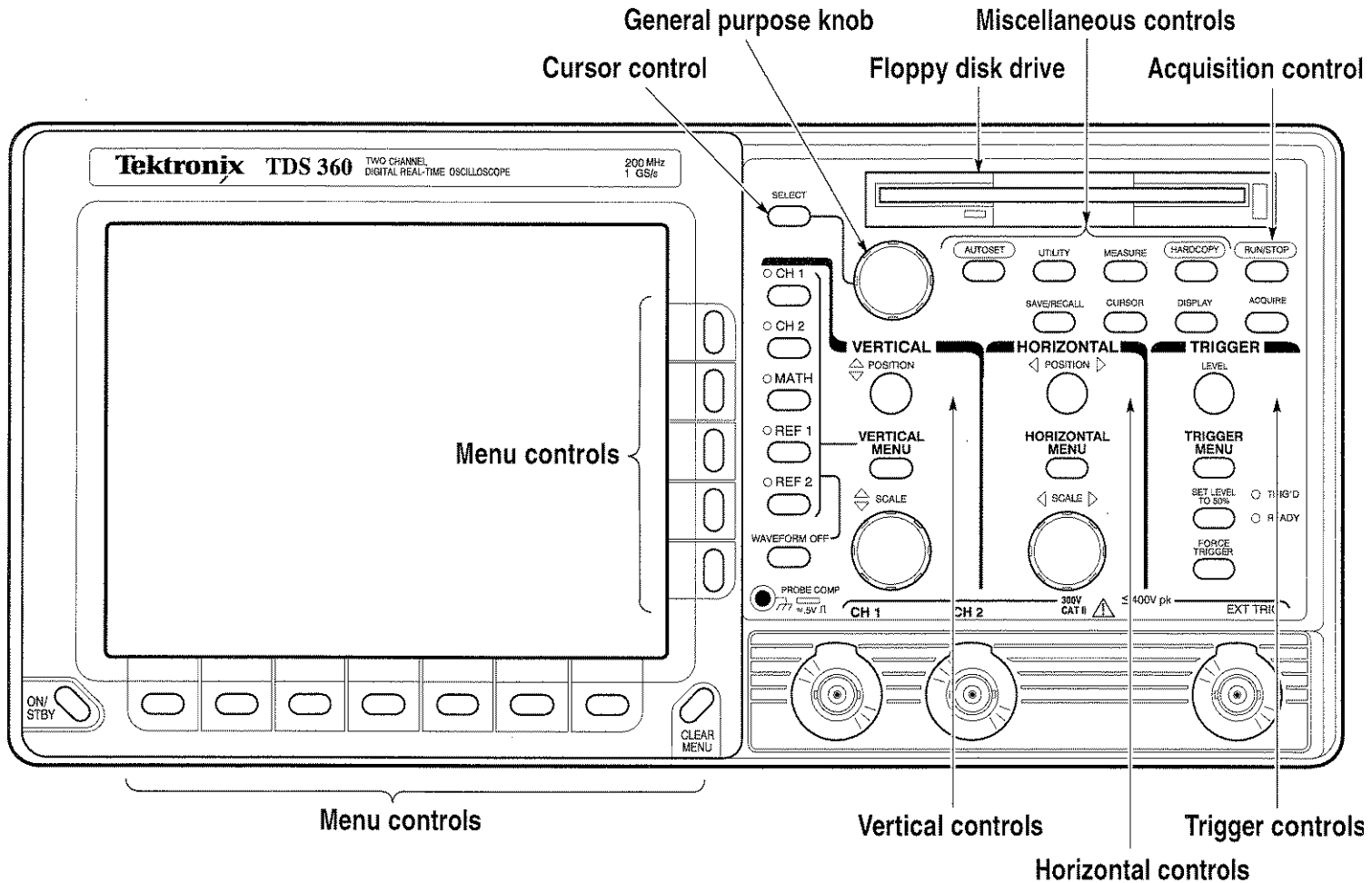

Vertical Controls

CH 1 and CH 2 assign instrument control to the selected channel, indicated with a lighted LED.

MATH displays the menu choices for the math operations and activates the math waveform.

REF1 and REF2 activate the reference waveforms and display the menu choices for saving a waveform.

POSITION moves the waveform vertically.

VERTICAL MENU displays the menu choices for the vertical system.

SCALE adjusts the vertical scale.

WAVEFORM OFF clears the selected waveform from the display.

Horizontal Controls

POSITION moves the waveform horizontally.

HORIZONTAL MENU displays the menu choices for the horizontal system.

SCALE adjusts the horizontal scale.

Trigger Controls

LEVEL selects the trigger level threshold.

TRIGGER MENU displays the menu choices for the triggering system.

TRIG'D indicates that the oscilloscope is triggered on a signal.

READY indicates that the trigger circuit is ready to accept a trigger.

FORCE TRIGGER forces a single trigger regardless of trigger level.

SET LEVEL TO 50% sets the trigger level threshold to the midpoint of the input signal.

Primary Menu Map

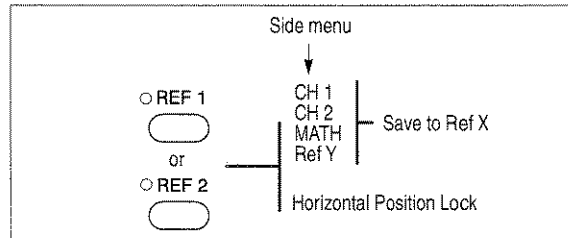
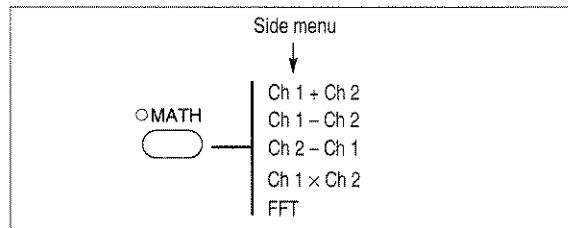
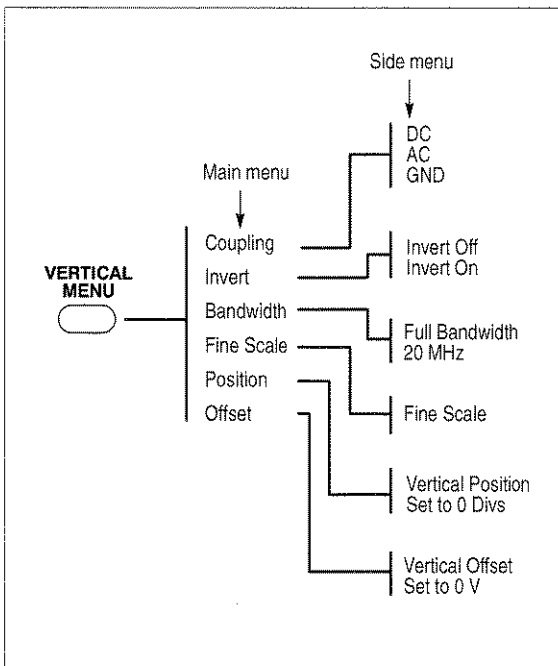
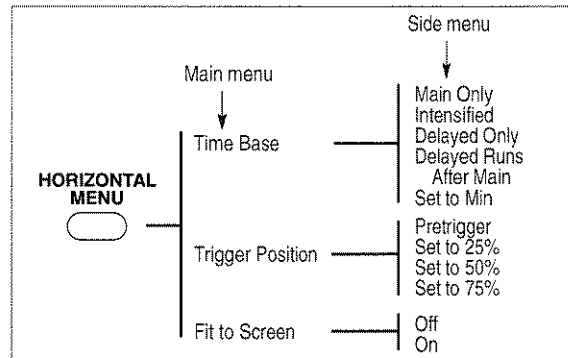
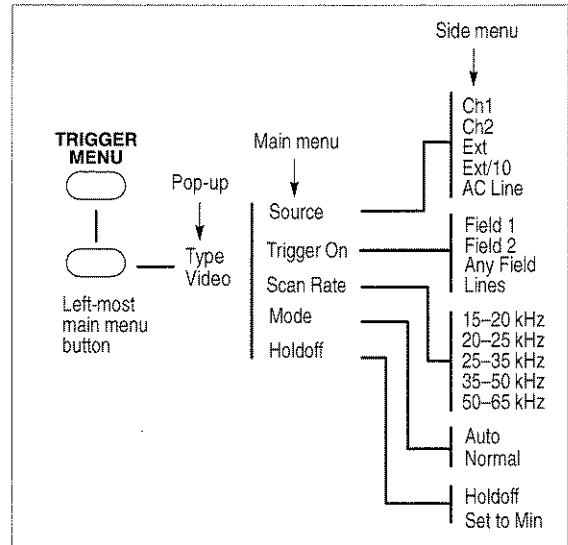
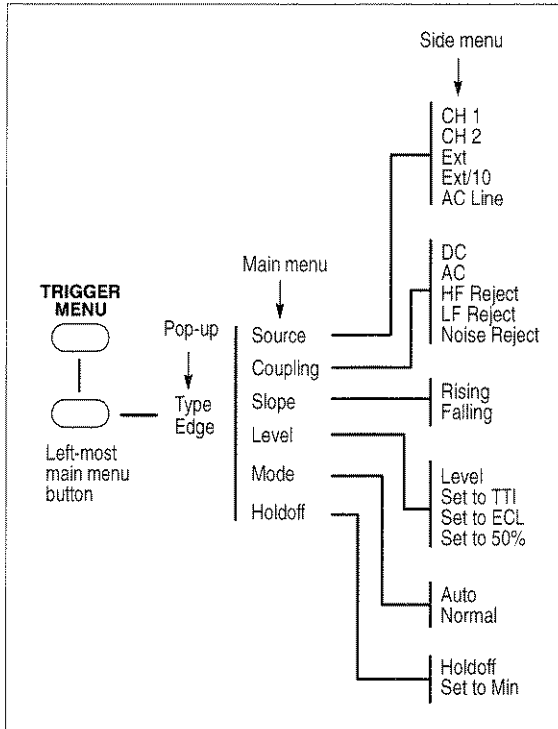

Secondary Menu Map

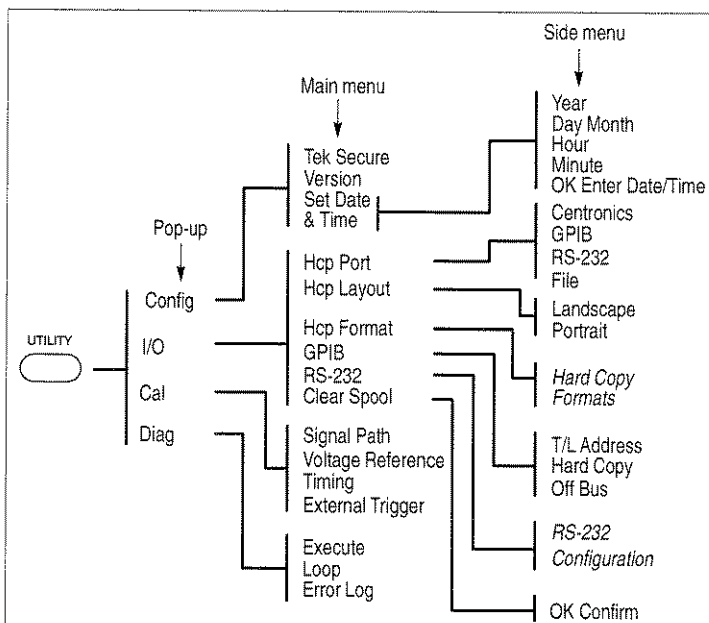
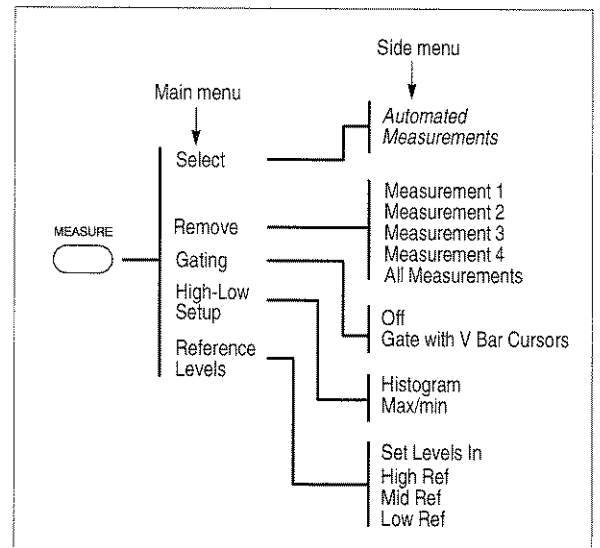
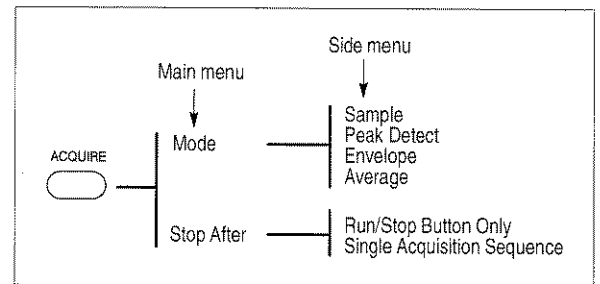
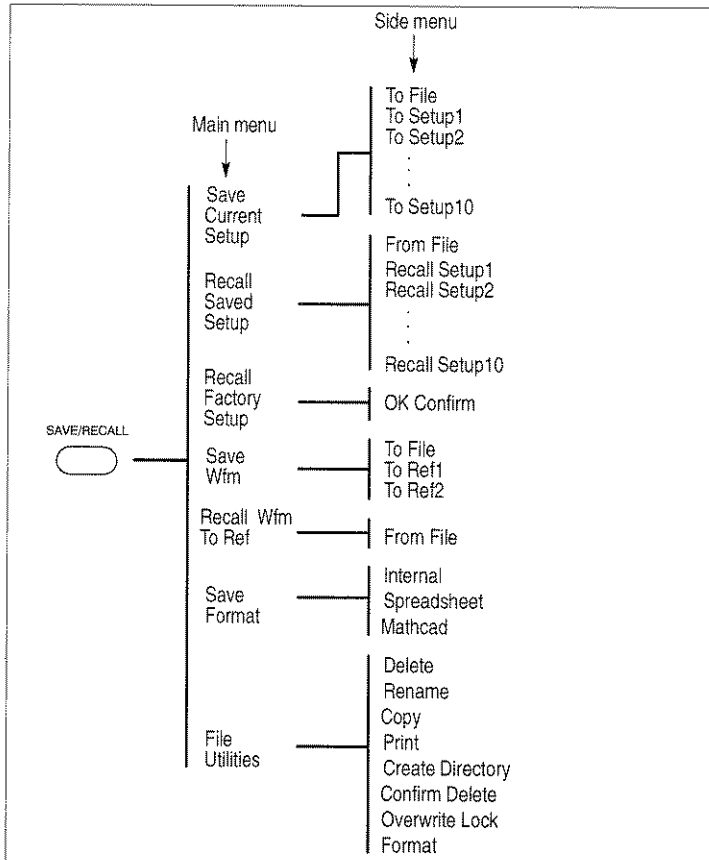
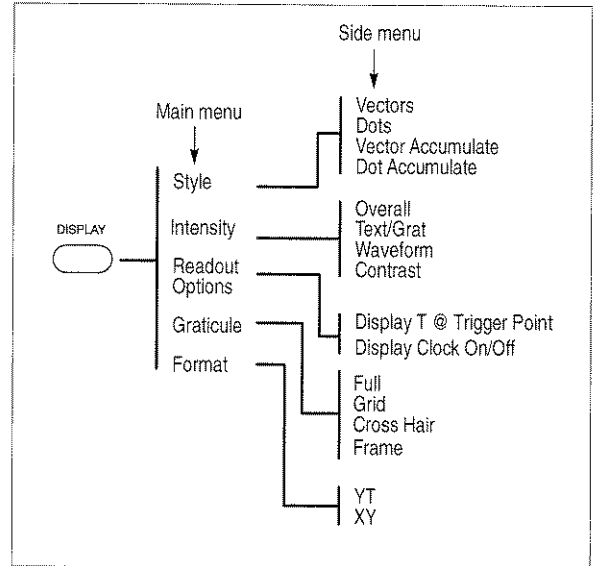
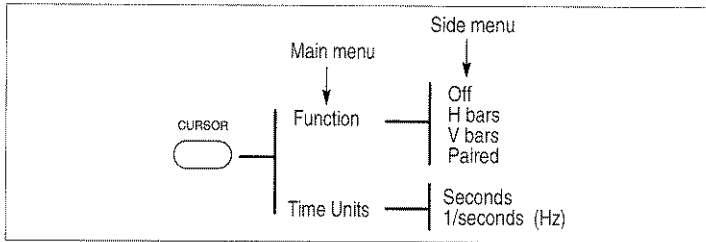

Note: Italic entries indicate menus not shown.

Fonctionnement d'un menu

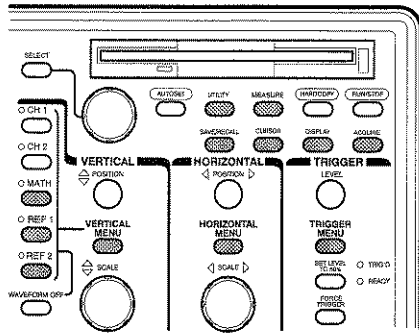

1. Appuyez sur une touche de menu de la face avant.

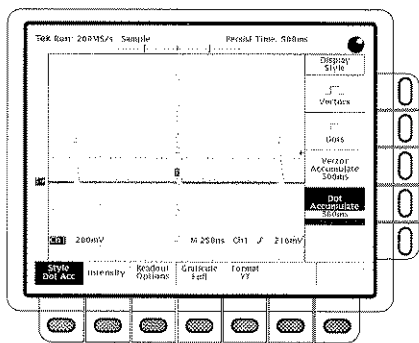

2. Sélectionnez une option dans le menu principal (en bas de l'écran).

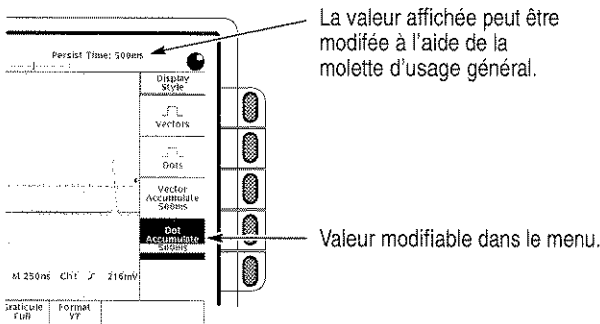

3. Sélectionnez une option dans le menu latéral, s'il est affiché.

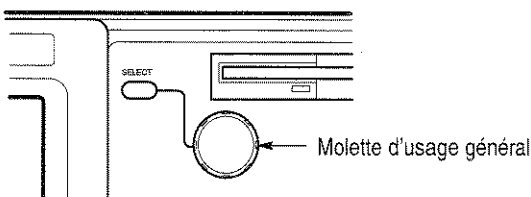

4. Réglez les valeurs modifiables du menu à l'aide de la molette d'usage général.

Commandes

Commande du curseur

SELECT sélectionne le curseur qui doit être commandé par la molette d'usage général.

Molette d'usage général

La molette d'usage général gère diverses opérations en fonction du dernier menu effectué.

Commandes diverses

AUTOSET règle automatiquement les commandes de l'appareil afin d'obtenir un affichage utilisable du signal.

UTILITY affiche les menus de configuration, E/S, calibration et diagnostic.

SAVE/RECALL affiche le menu qui permet d'enregistrer et de rappeler les signaux et les configurations de la face avant. Vous pouvez aussi utiliser SAVE/RECALL pour accéder aux utilitaires des fichiers sur disquettes.

MEASURE affiche le menu de mesure automatique.

CURSOR affiche les options du menu relatif aux curseurs.

HARDCOPY démarre les opérations de recopie d'écran.

DISPLAY affiche le menu qui permet de modifier les paramètres de visualisation.

Commandes d'acquisition

RUN/STOP démarre et arrête l'acquisition.

ACQUIRE affiche le menu de commande d'acquisition.

Commandes de menu

Les commandes de menu fonctionnent comme décrit sous *Fonctionnement d'un menu*.

CLEAR MENU efface la plupart des menus de l'écran.

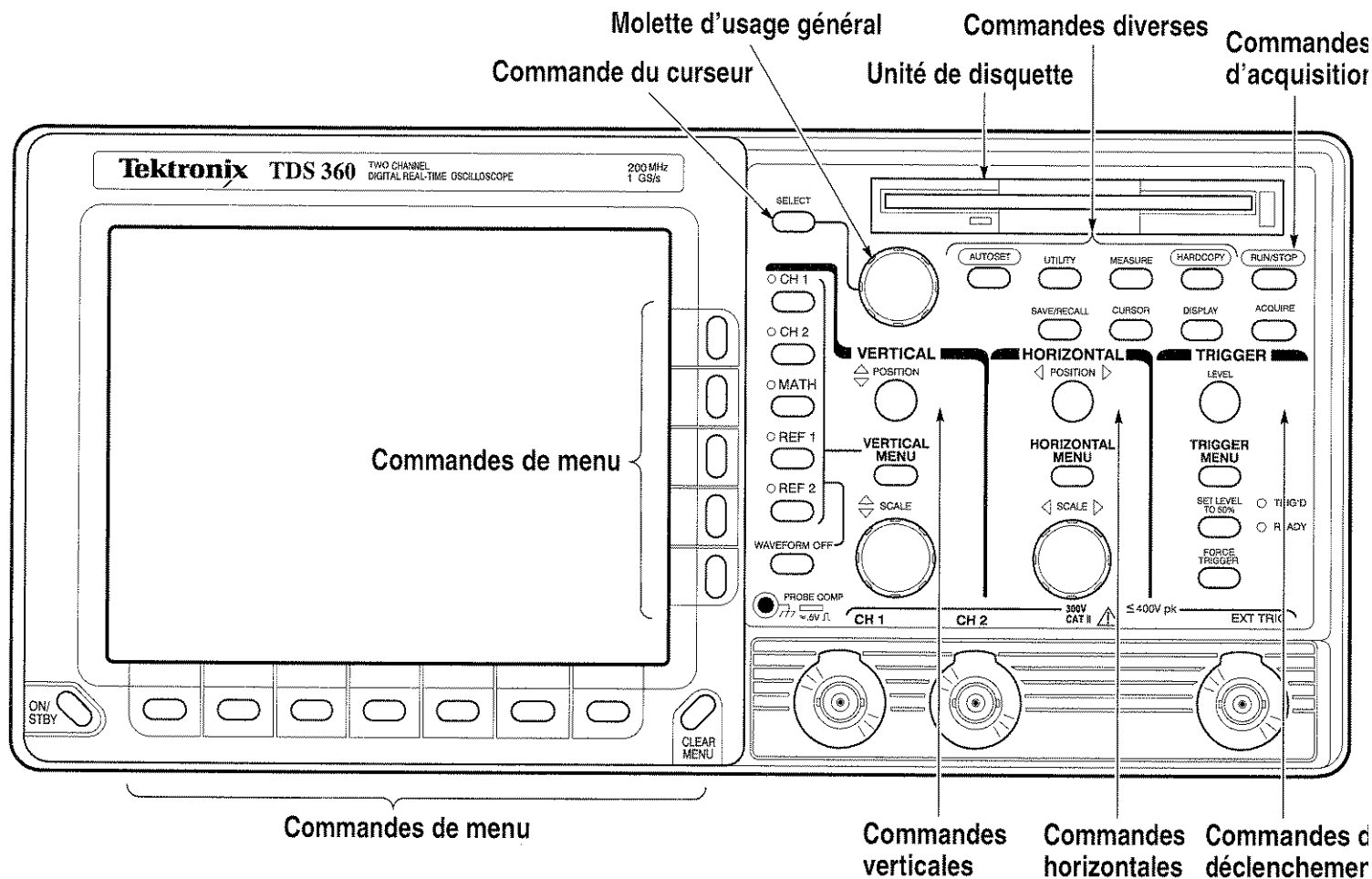

Commandes verticales

CH1 et CH2 permettent de sélectionner la voie d'acquisition. Le témoin lumineux correspondant s'allume.

MATH affiche les options de menu concernant les opérations mathématiques et active le signal mathématique.

REF1 et REF2 activent les signaux de référence et affichent les options de menu permettant d'enregistrer un signal.

POSITION règle la position verticale du signal.

VERTICAL MENU affiche les options de menu du système vertical.

SCALE règle l'échelle verticale.

WAVEFORM OFF efface le signal sélectionné de l'écran.

Commandes horizontales

POSITION règle la position horizontale du signal.

HORIZONTAL MENU affiche les options de menu du système horizontal.

SCALE règle l'échelle horizontale.

Commandes de déclenchement

LEVEL sélectionne le seuil de déclenchement.

TRIGGER MENU affiche les options de menu du système de déclenchement.

TRIG'D indique que l'oscilloscope est déclenché sur réception d'un signal.

READY indique que le circuit de déclenchement est prêt à recevoir un signal de déclenchement.

FORCE TRIGGER fait en sorte qu'un déclenchement se produise quel que soit le niveau de déclenchement.

SET LEVEL TO 50% fixe le niveau de déclenchement à la valeur milieu du signal de déclenchement.

Menus et sous-menus primaires

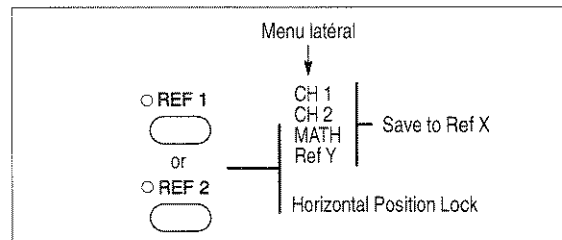
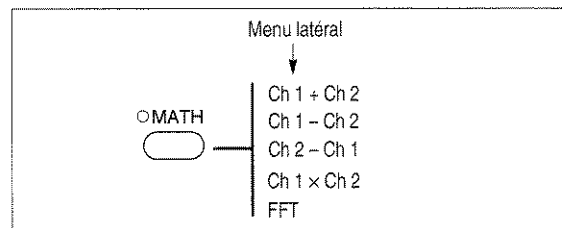
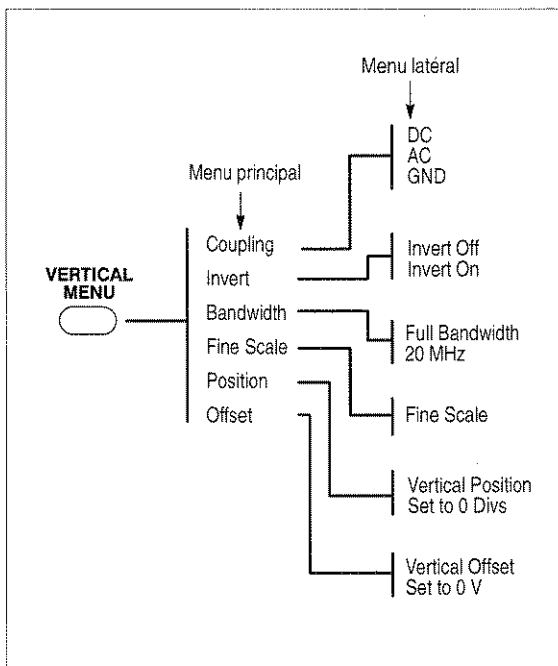
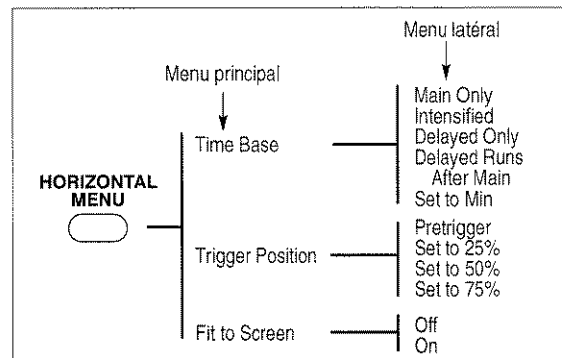
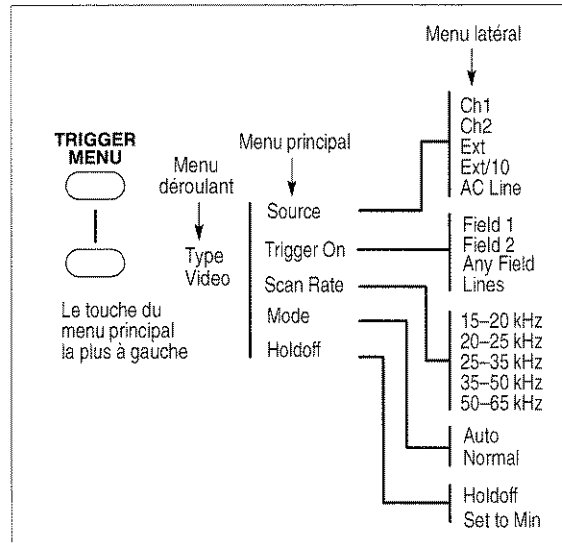
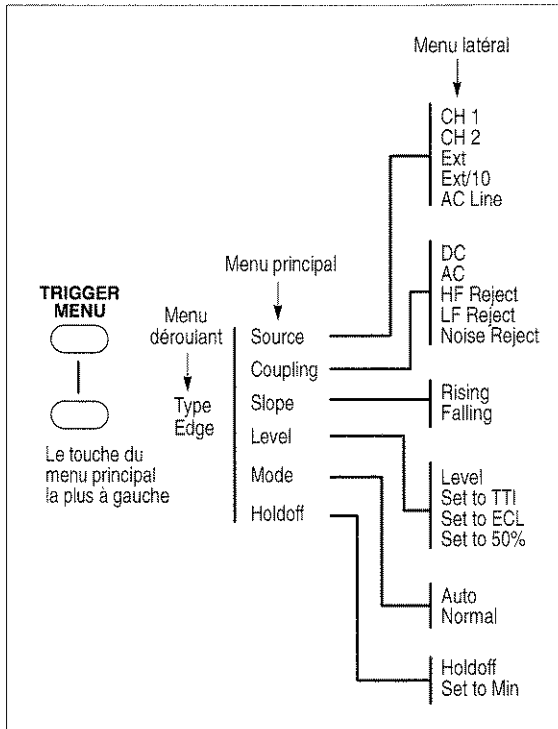

Menus et sous-menus secondaires

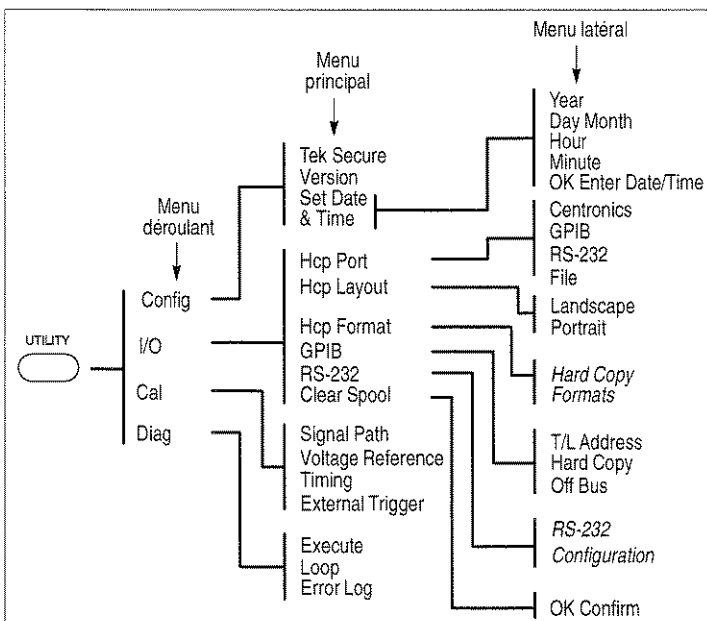
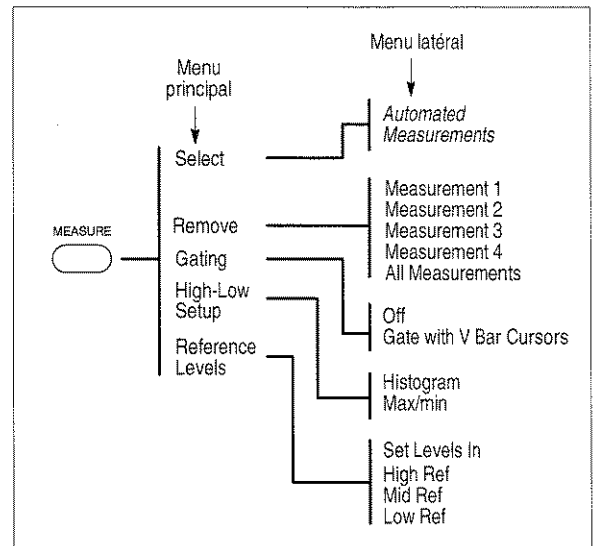
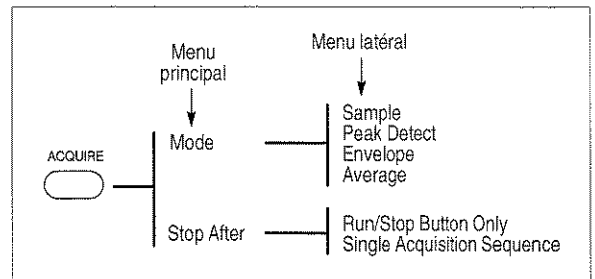
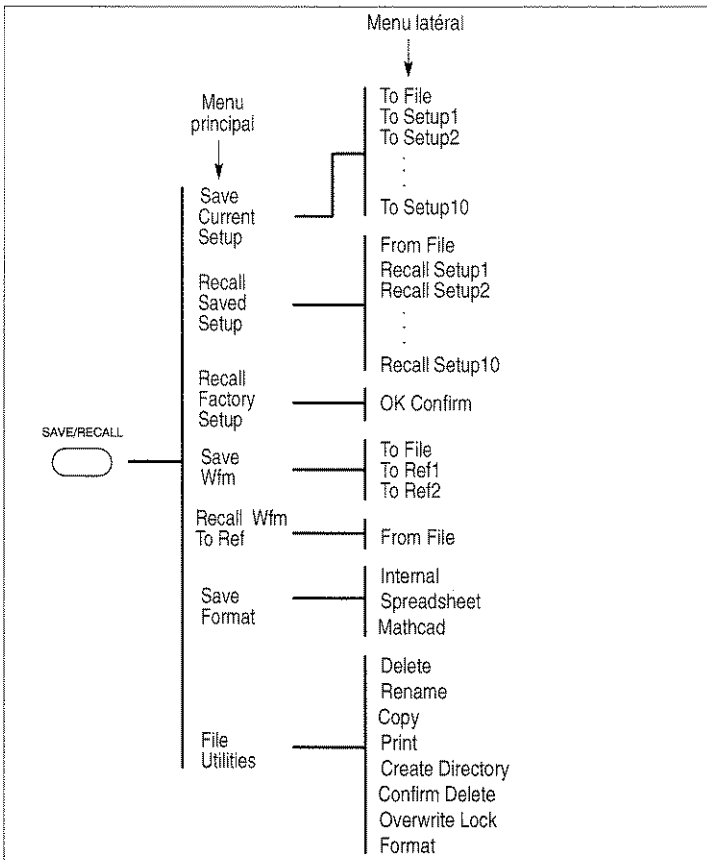
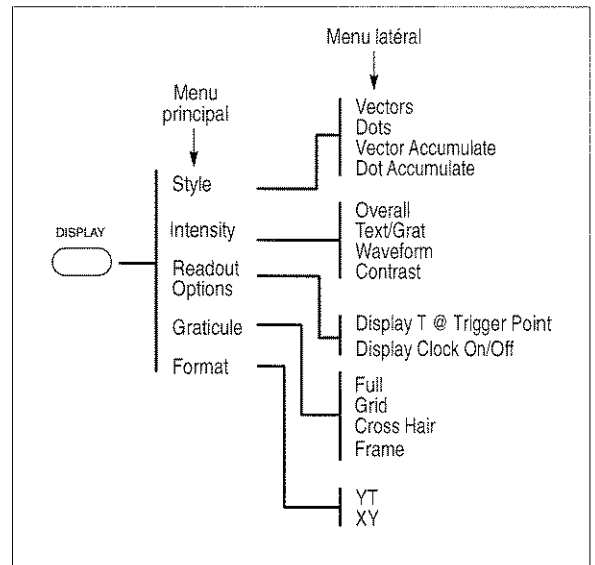
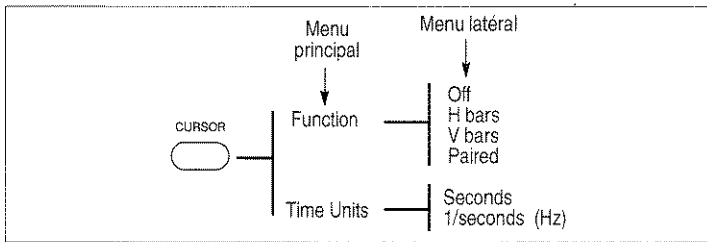

Remarque: Les menus en italique ne sont pas affichés.

Menübetrieb

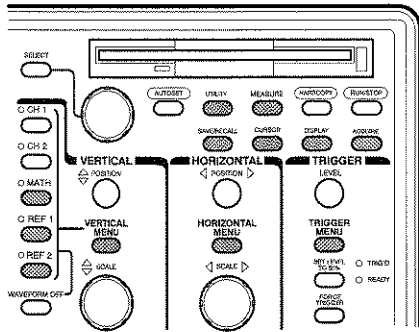

1. Drücken Sie irgendeine der Menüasten an der Frontplatte.

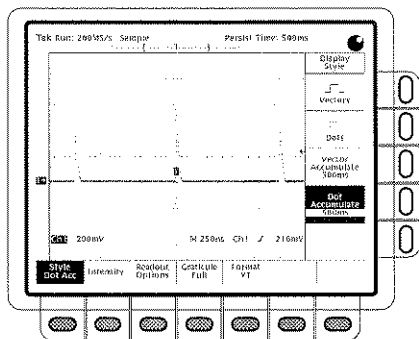

2. Wählen Sie aus dem Hauptmenü (am unteren Rand) eine Menüoption.

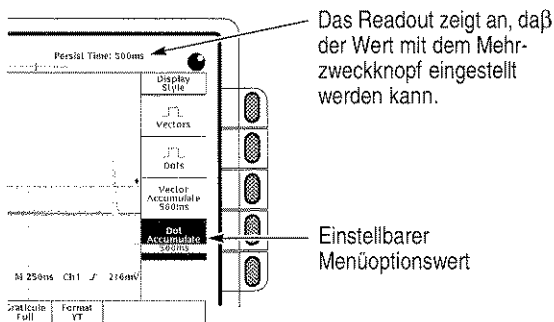

3. Wählen Sie eine Option aus dem Seitenmenü aus, wenn es angezeigt ist.

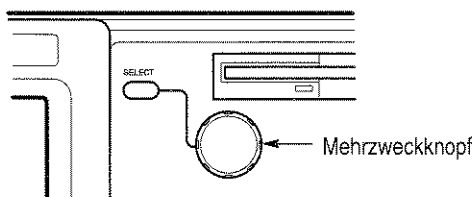

4. Justieren Sie die Menüoptionswerte mit Hilfe des Mehrzweckknopfes.

Steuerungen

Cursorsteuerung

SELECT schaltet die mit dem Mehrzweckknopf gewählte Zuordnung zwischen den angezeigten Meß cursoren um.

Mehrzweckknopf

Der Mehrzweckknopf steuert verschiedene Funktionen, abhängig vom zuletzt ausgewählten Menü.

Allgemeine Steuerungen

AUTOSET stellt das Gerät automatisch so ein, daß eine brauchbare Darstellung erzeugt wird.

UTILITY zeigt das Konfigurations-, E/A-, Systemkalibrierungs- oder Diagnosemenü an.

SAVE/RECALL zeigt das Menü zum Speichern und Aufrufen der Signale und Frontplatten-Einstellungen an und ermöglicht Ihnen den Zugriff auf Datedienstprogramme für das Diskettenlaufwerk.

MEASURE zeigt das automatische Meßmenü an.

CURSOR zeigt die Menüoptionen für die Cursormodi an.

HARDCOPY leitet den Papierausdruck ein.

DISPLAY zeigt das Menü zur Änderung der Bildschirmparameter an.

Erfassungssteuerungen

RUN/STOP aktiviert und deaktiviert die Erfassung.

ACQUIRE zeigt das Erfassungssteuermenü an.

Menüsteuerungen

Die Funktionsweise der Menüsteuerungen ist im Abschnitt *Menübetrieb* beschrieben.

CLEAR MENU löscht die meisten Menüs vom Bildschirm.

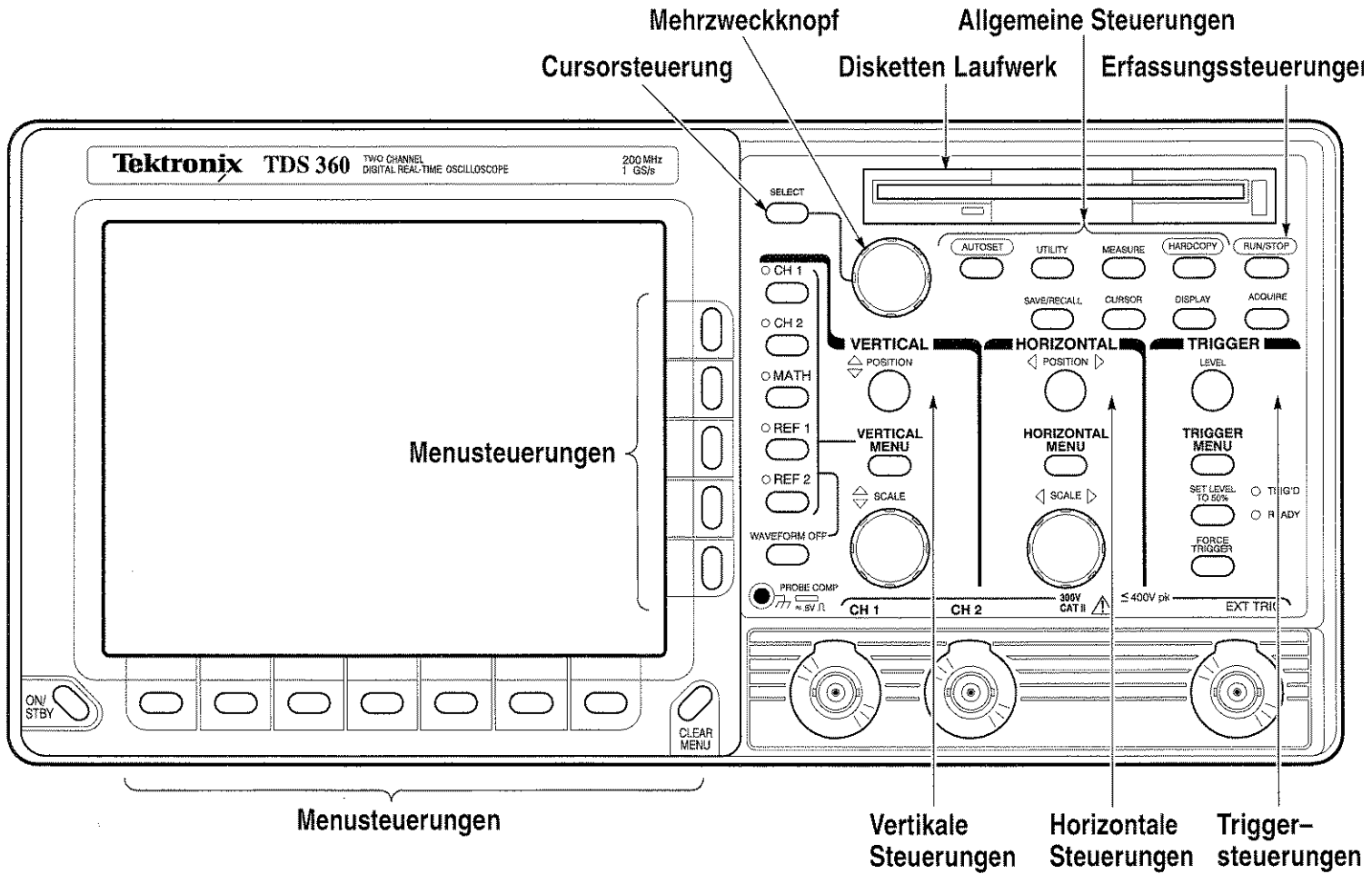

Vertikale Steuerungen

CH1 und CH2 übertragen die Gerätesteuerung auf den ausgewählten Kanal, der durch eine leuchtende LED-Diode angezeigt wird.

MATH zeigt die Menüoptionen für die Rechenoperationen an und aktiviert das mathematische Signal.

REF1 und REF2 aktivieren die Bezugssignale und zeigen die Menüoptionen für das Speichern eines Signals an.

POSITION bewegt das Signal in vertikaler Richtung.

VERTICAL MENU zeigt die Menüoptionen für das Vertikalsystem an.

SCALE justiert die Vertikalskala.

WAVEFORM OFF löscht das gewählte Signal von der Anzeige.

Horizontale Steuerungen

POSITION bewegt das Signal in horizontaler Richtung.

HORIZONTAL MENU zeigt die Menüoptionen für das Horizontalsystem an.

SCALE justiert die Horizontalskala.

Triggersteuerungen

LEVEL wählt die Triggerpegel-Schwelle.

TRIGGER MENU zeigt die Menüoptionen für das Triggersystem an.

TRIG'D zeigt an, daß das Oszilloskop ein Signal antriggert.

READY zeigt an, daß der Trigger-Schaltkreis für die Annahme eines Triggers bereit ist.

FORCE TRIGGER erzwingt einen einfachen Trigger, unabhängig vom Triggerpegel.

SET LEVEL TO 50% bringt die Triggerpegel-Schwelle auf die Mitte des Eingangssignals.

Menükarte mit Primärfunktionen

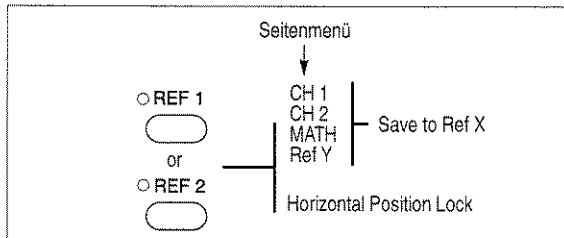
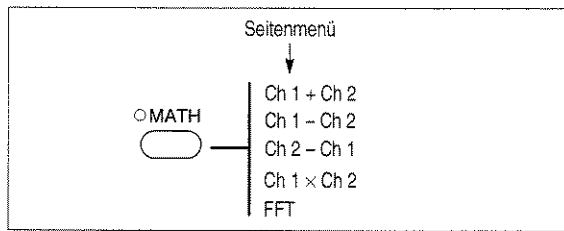
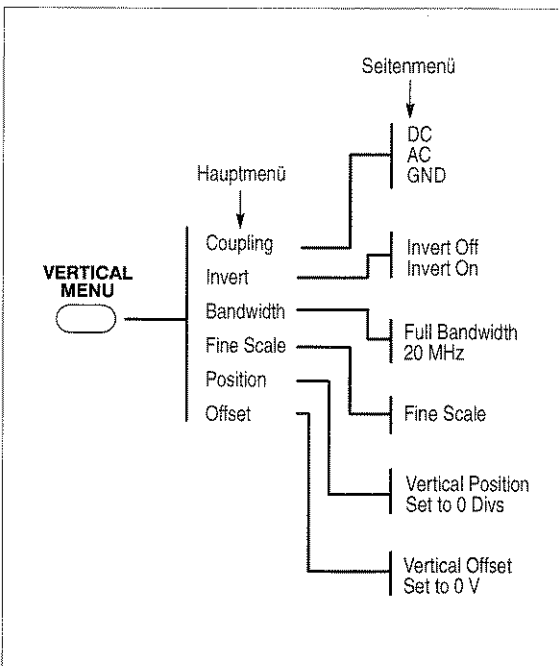
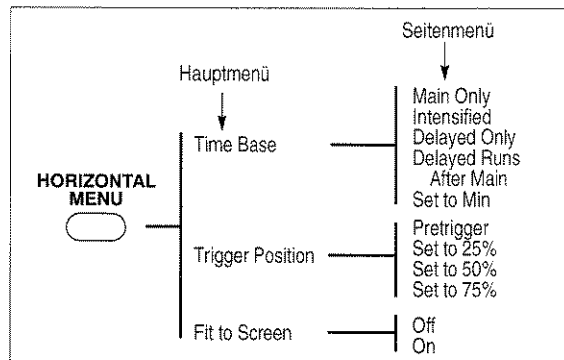
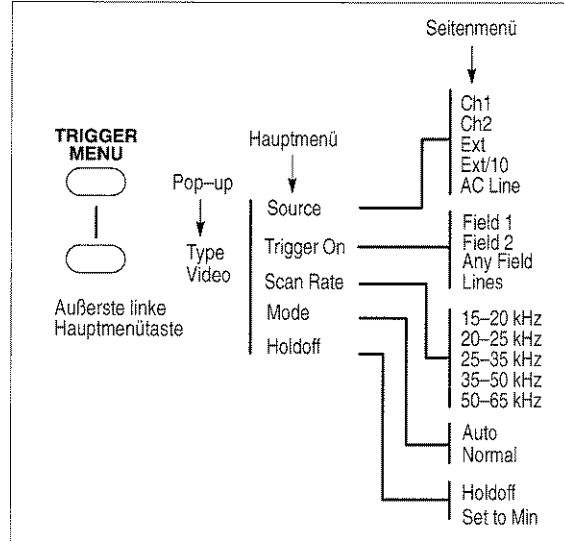
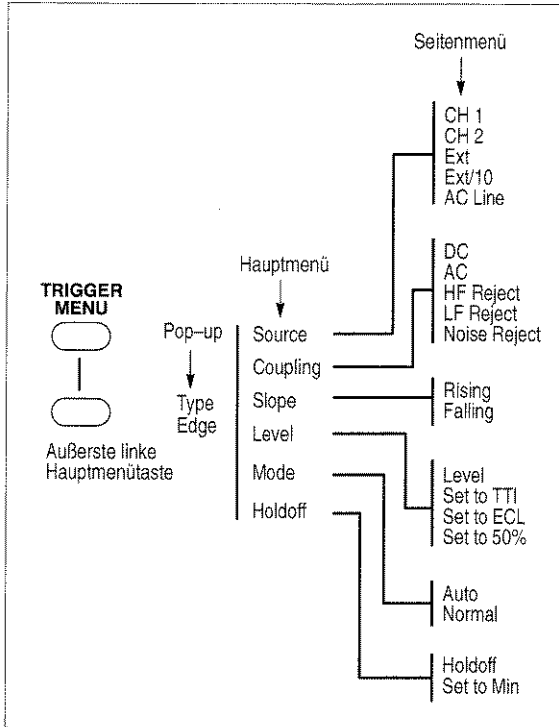

Menükarte mit Sekundärfunktionen

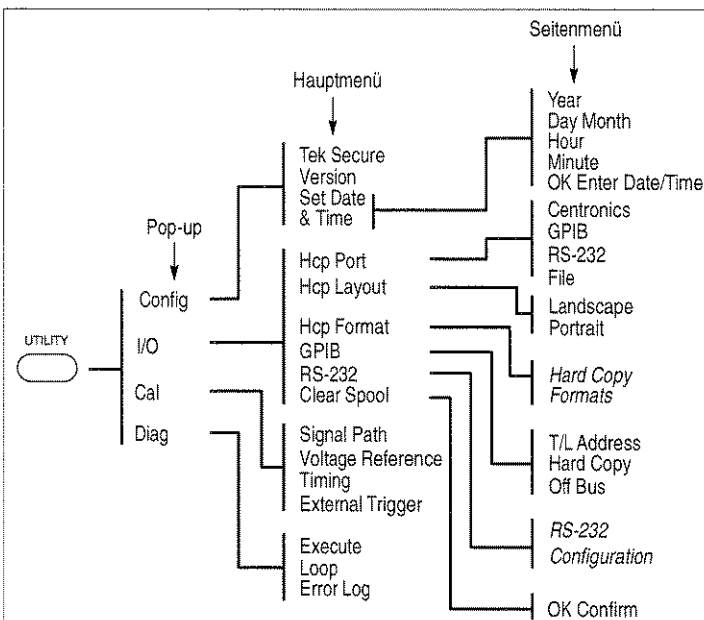
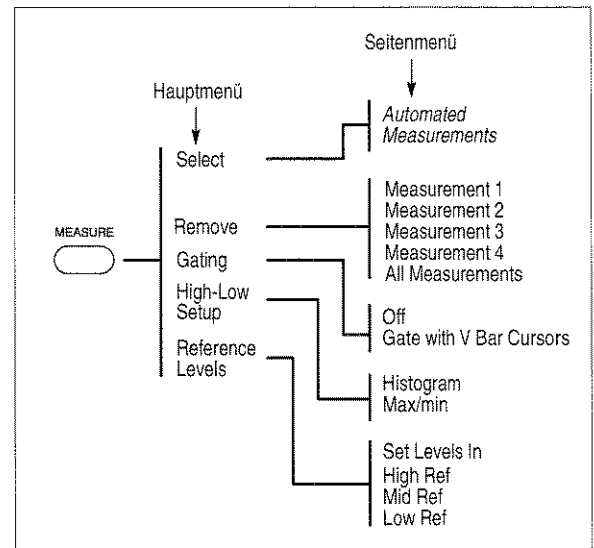
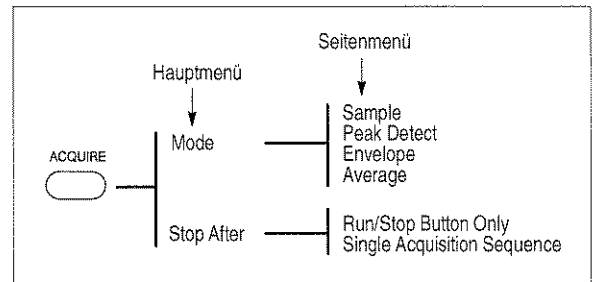
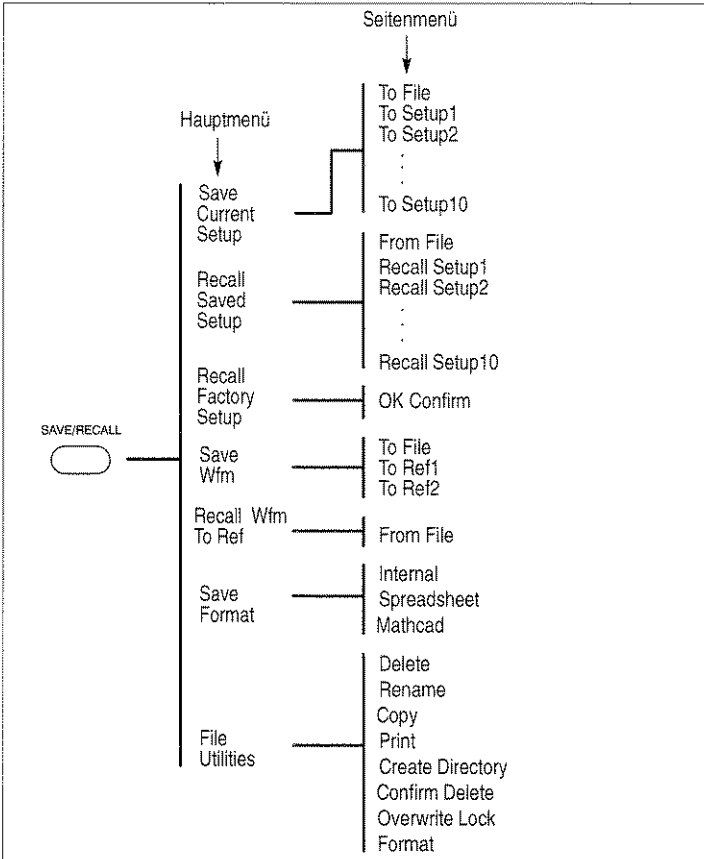
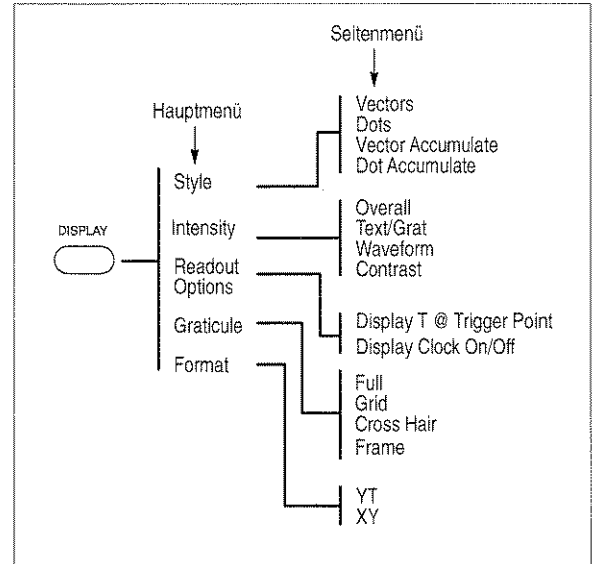
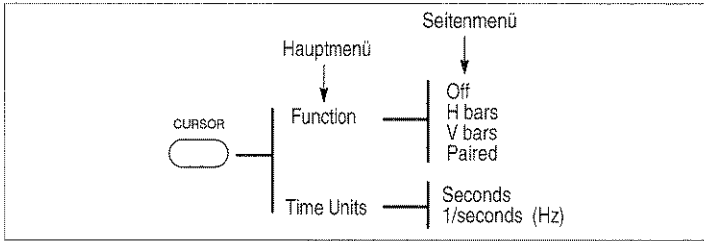

Hinweis: Einträge in Kursivschrift bedeuten nicht gezeigte Menüs.

Operación del Menú

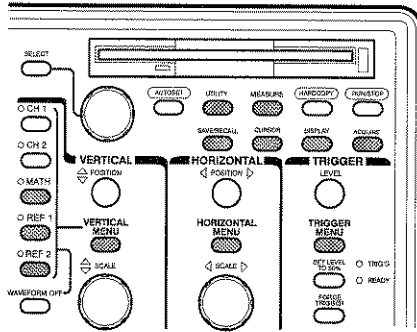

1. Pulse cualquiera de los botones del menú del panel frontal.

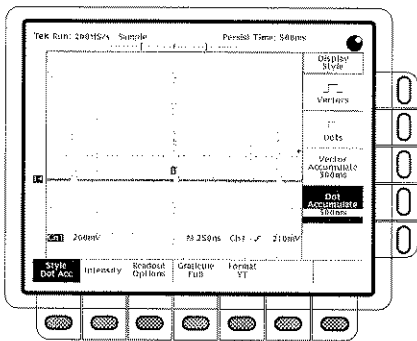

2. Seleccione un elemento del menú principal (abajo).

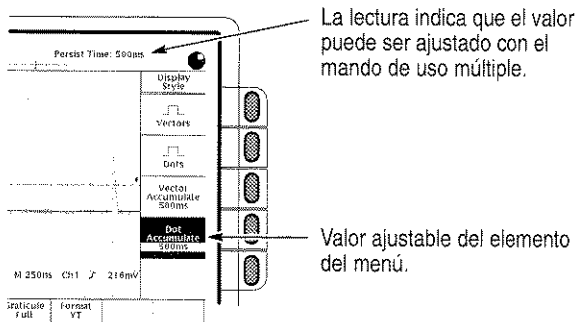

3. Seleccione un elemento del menú auxiliar, si aparece en la pantalla.

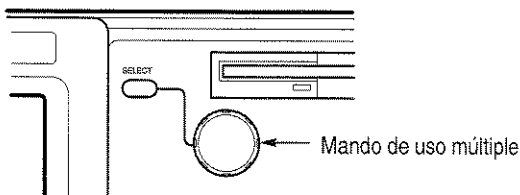

4. Ajuste los valores de los elementos del menú con el mando de uso múltiple.

Controles

Control de los Cursores

SELECT cambia la asignación del mando de uso múltiple entre los cursores de medida mostrados.

Mando de Uso Múltiple

El mando de uso múltiple controla varias operaciones, dependiendo del último menú seleccionado.

Controles Varios

AUTOSET ajusta automáticamente los controles del instrumento para obtener una visualización útil.

UTILITY muestra los menús de la configuración, el E/S, la calibración, y el diagnóstico.

SAVE/RECALL muestra el menú para guardar y recuperar las formas de onda y las configuraciones del panel frontal. También puede usar SAVE/RECALL para acceder a las utilidades del fichero de disquete.

MEASURE muestra el menú de medidas automatizadas.

CURSOR muestra las operaciones del menú para los modos de operación del cursor.

HARDCOPY empieza las operaciones de copias impresas.

DISPLAY muestra el menú para alterar los parámetros de la pantalla.

Controles de Adquisición

RUN/STOP empieza y detiene la adquisición.

ACQUIRE muestra la adquisición del menú de controles.

Controles del Menú

Los controles del menú funcionan de la manera descrita en *Operación del Menú*.

CLEAR MENU borra la mayoría de los menús de la pantalla.

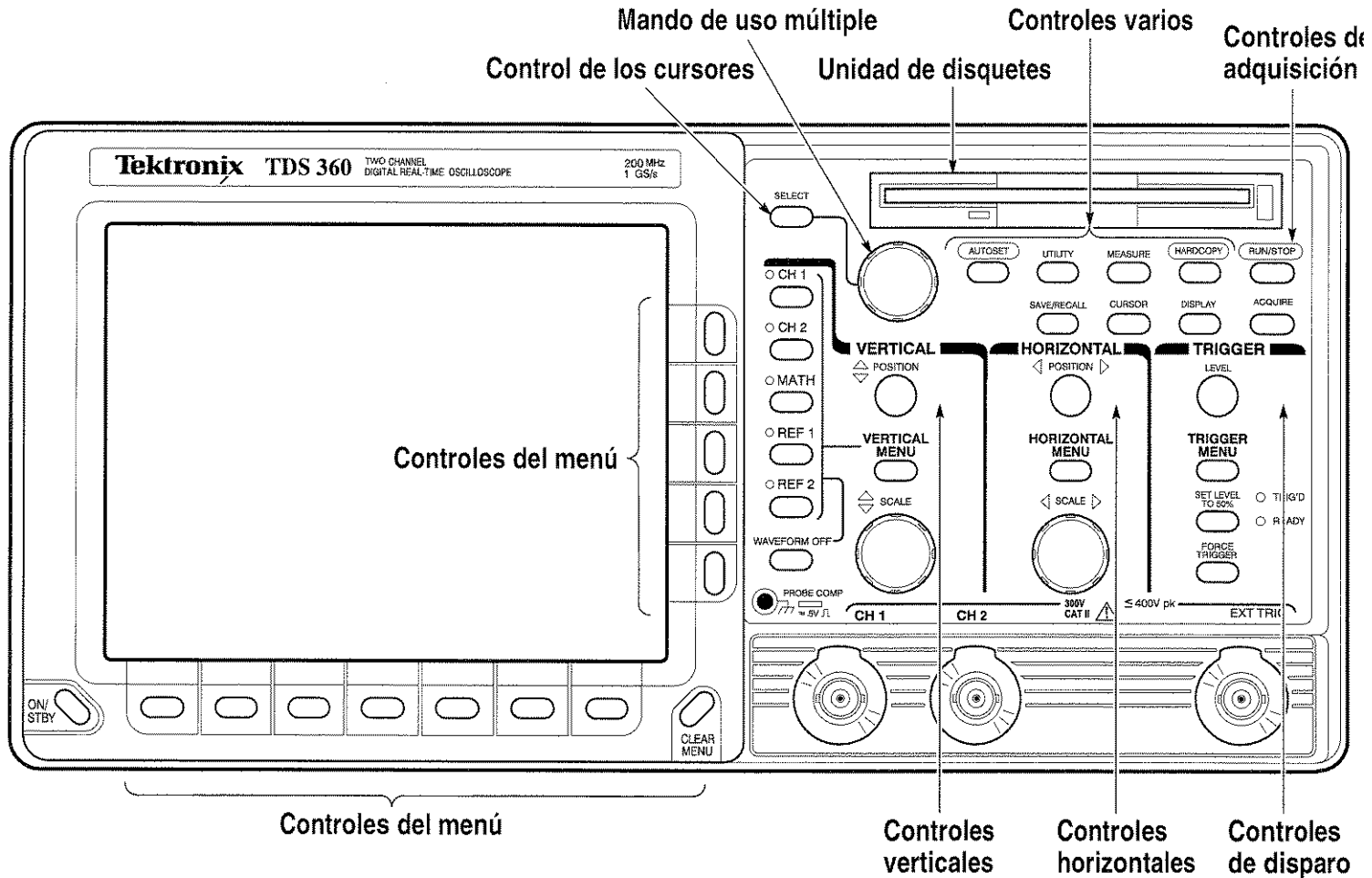

Controles Verticales

CH1 y CH2 asignan el control del instrumento al canal seleccionado, indicado con un diodo emisor de luz encendido.

MATH muestra las elecciones del menú para las operaciones matemáticas y activa la forma de onda matemática.

REF1 y REF2 activan las formas de onda de referencia y muestran las elecciones del menú para guardar una forma de onda.

POSITION mueve la forma de onda verticalmente.

VERTICAL MENU muestra las elecciones del menú para el sistema vertical.

SCALE ajusta la escala vertical.

WAVEFORM OFF borra de la pantalla la forma de onda seleccionada.

Controles Horizontales

POSITION mueve la forma de onda horizontalmente.

HORIZONTAL MENU muestra las elecciones del menú para el sistema horizontal.

SCALE ajusta la escala horizontal.

Controles de Disparo

LEVEL selecciona el umbral del nivel de disparo.

TRIGGER MENU muestra las elecciones del menú para el sistema de disparo.

TRIG'D indica que el osciloscopio es disparado sobre una señal.

READY indica que el circuito de disparo está listo para aceptar un disparo.

FORCE TRIGGER fuerza un disparo sencillo independientemente del nivel de disparo.

SET LEVEL TO 50% establece el umbral del nivel de disparo al punto medio de la señal de entrada.

Esquema del Menú Principal

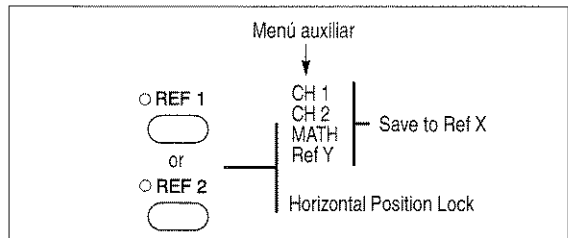
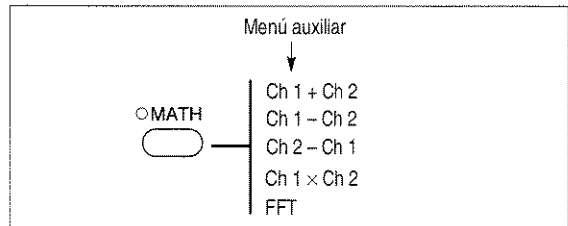
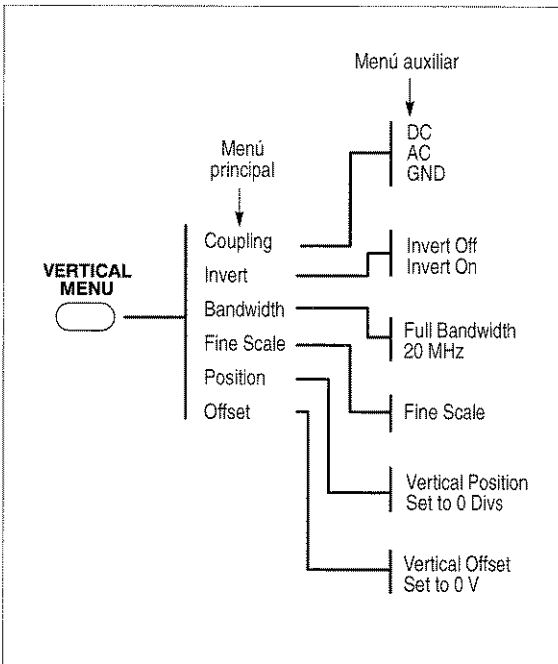
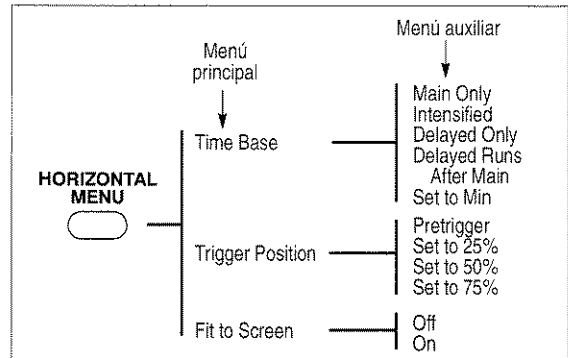
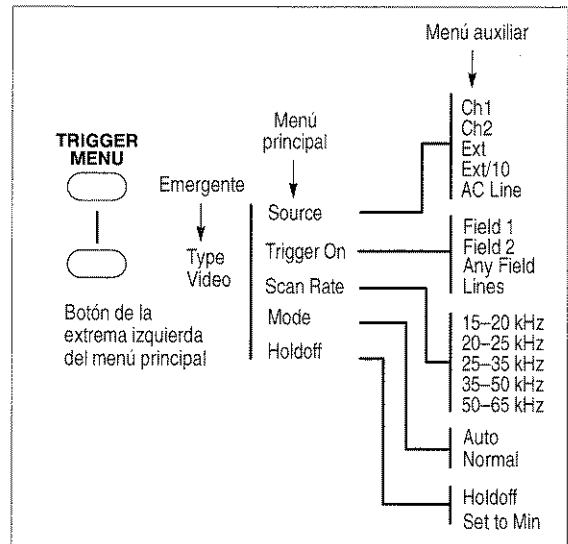
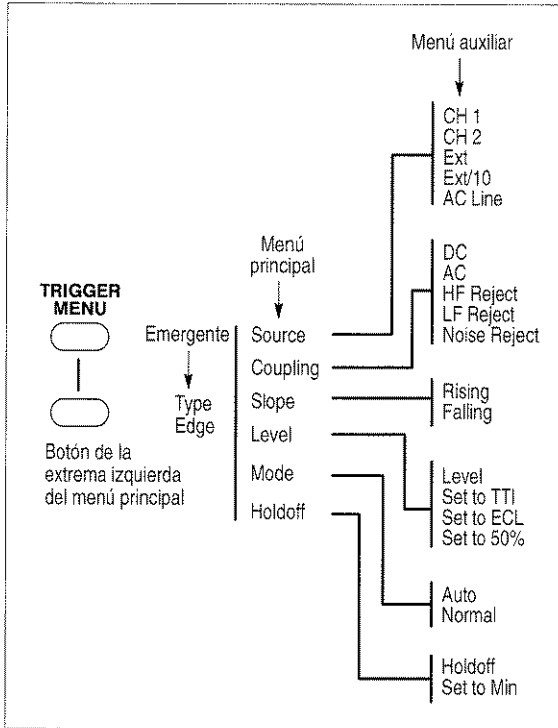

Esquema del Menú Secundario

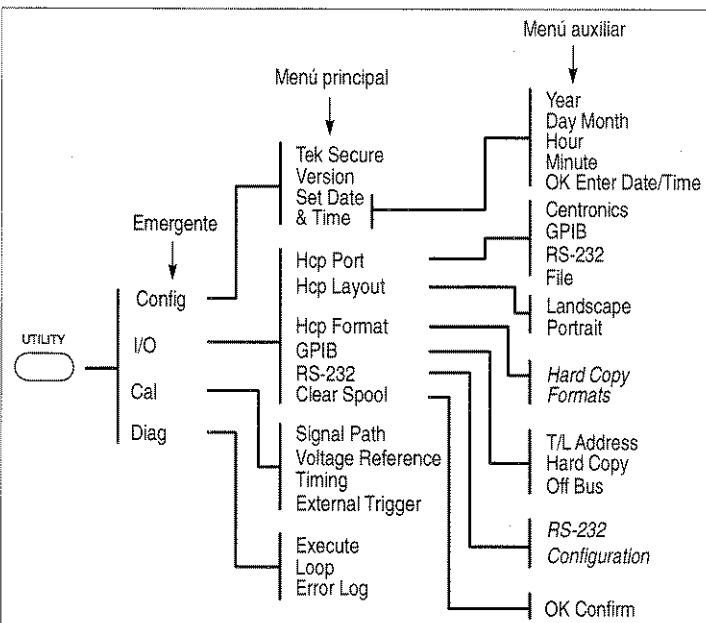
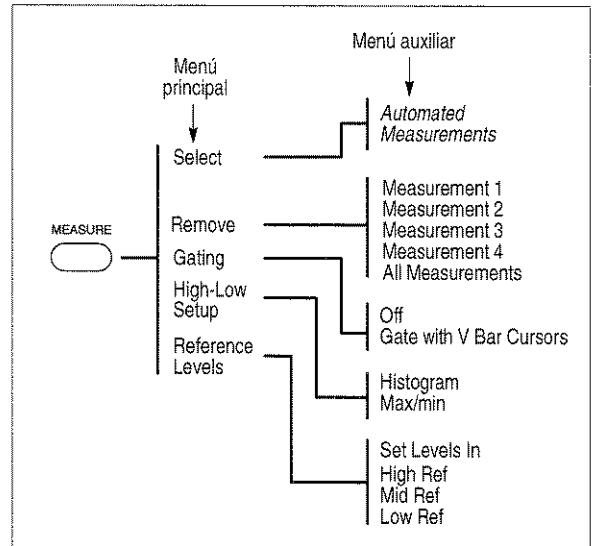
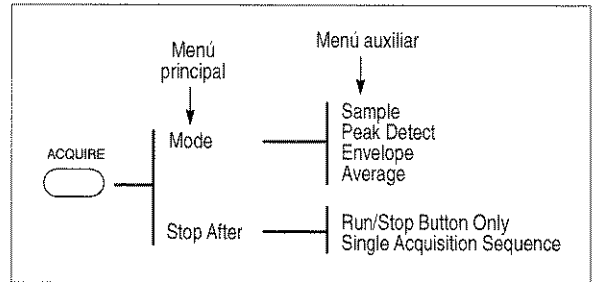
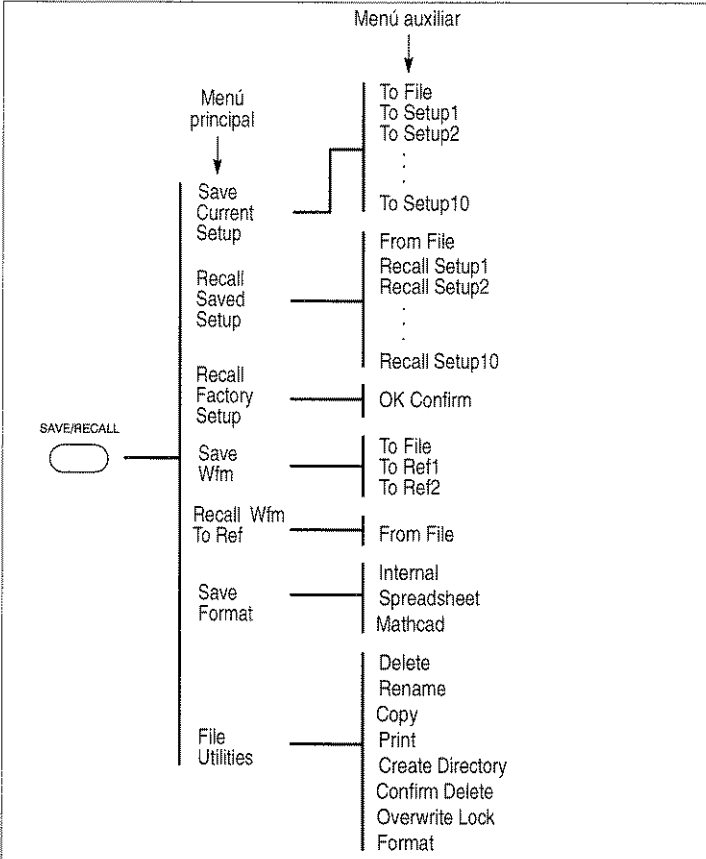
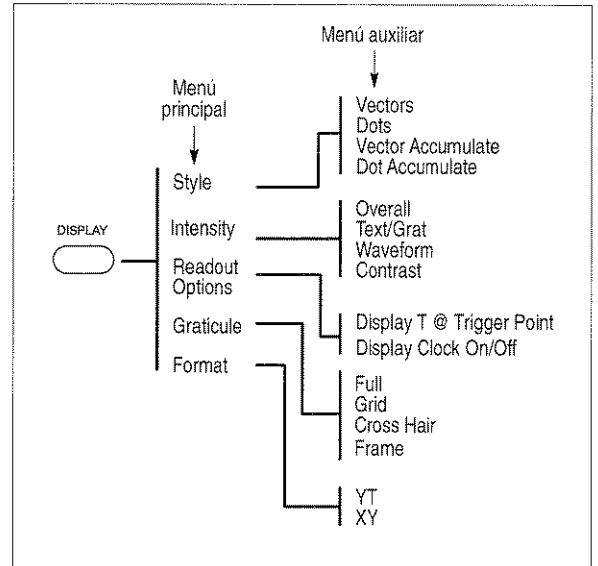
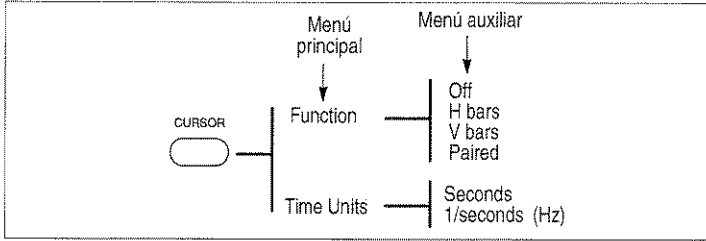

Nota: Los datos en letra cursiva indican menús no mostrados.

