

## PENTODE

FOR TV VIDEO AMPLIFIER APPLICATIONS

### DESCRIPTION AND RATING

The 12BY7-A is a miniature power pentode designed primarily for use as the video output amplifier in television receivers. Features of the tube include extremely high transconductance, low interelectrode capacitances, and high power sensitivity.

Electrically and mechanically, the 12BY7-A is a replacement for the 12BY7. In addition, however, the 12BY7-A exhibits a controlled heater warm-up characteristic which makes the tube particularly suited for use in television receivers which employ series-connected heaters. When the 12BY7-A is used in conjunction with other 600-milliampere types which exhibit essentially the same heater warm-up characteristic, heater voltage surges across the individual tubes are minimized during the warm-up period.

#### GENERAL

##### ELECTRICAL

Cathode—Coated Unipotential

	Series	Parallel
Heater Voltage, AC or DC.....	12.6	6.3 Volts
Heater Current.....	0.3	0.6 Amperes
Heater Warm-up Time*.....	..	11 Seconds

Direct Interelectrode Capacitances†

Grid-Number 1 to Plate, maximum.....	0.063 $\mu\mu\text{f}$
Input.....	10.2 $\mu\mu\text{f}$
Output.....	3.5 $\mu\mu\text{f}$

##### MECHANICAL

Mounting Position—Any

Envelope—T-6½, Glass

Base—E9-1, Small Button 9-Pin

#### MAXIMUM RATINGS

##### DESIGN-CENTER VALUES

Plate Voltage.....	300 Volts
Screen Voltage.....	180 Volts
Positive DC Grid-Number 1 Voltage.....	0 Volts
Negative DC Grid-Number 1 Voltage.....	50 Volts
Plate Dissipation.....	6.5 Watts
Screen Dissipation.....	1.1 Watts
Heater-Cathode Voltage	
Heater Positive with Respect to Cathode.....	200 Volts
Heater Negative with Respect to Cathode.....	200 Volts
Grid-Number 1 Circuit Resistance	
With Fixed Bias.....	0.25 Megohms
With Cathode Bias.....	1.0 Megohms

#### BASING DIAGRAM

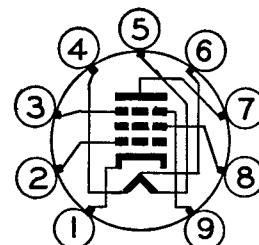

RETMA 9BF

#### TERMINAL CONNECTIONS

- Pin 1—Cathode
- Pin 2—Grid Number 1
- Pin 3—Internal Shield and Grid Number 3 (Suppressor)
- Pin 4—Heater
- Pin 5—Heater
- Pin 6—Heater Center-Tap
- Pin 7—Plate
- Pin 8—Grid Number 2 (Screen)
- Pin 9—Internal Shield and Grid Number 3 (Suppressor)

#### PHYSICAL DIMENSIONS

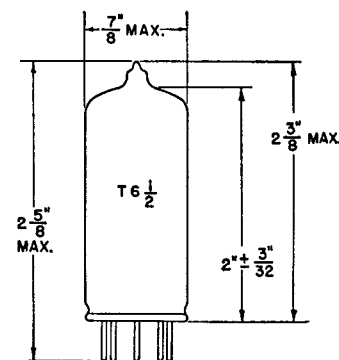

RETMA 6-3

**CHARACTERISTICS AND TYPICAL OPERATION**

**CLASS A<sub>1</sub> AMPLIFIER**

Plate Voltage .....	250	Volts
Suppressor, Connected to Cathode at Socket		
Screen Voltage .....	180	Volts
Cathode-Bias Resistor .....	100	Ohms
Plate Resistance, approximate .....	0.093	Megohms
Transconductance .....	11000	Micromhos
Plate Current .....	26	Milliamperes
Screen Current .....	5.75	Milliamperes
Grid-Number 1 Voltage, approximate		
IG = 20 Microamperes .....	-11.6	Volts
Triode Amplification Factor .....	28.5	

\* Heater warm-up time is defined as the time required in the circuit shown at the right for the voltage across the heater terminals (V) to increase from zero to the heater test Voltage (V<sub>1</sub>). For this type, E=25 volts (RMS or DC), V<sub>1</sub>=5.0 volts (RMS or DC), and R=31.5 ohms.

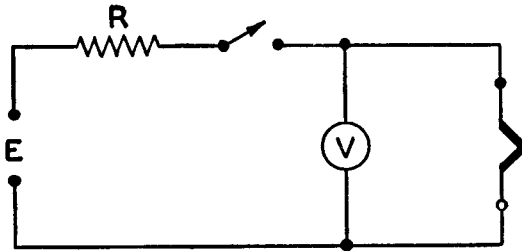

Heater of Tube under Test

† Without external shield.

**AVERAGE PLATE CHARACTERISTICS**

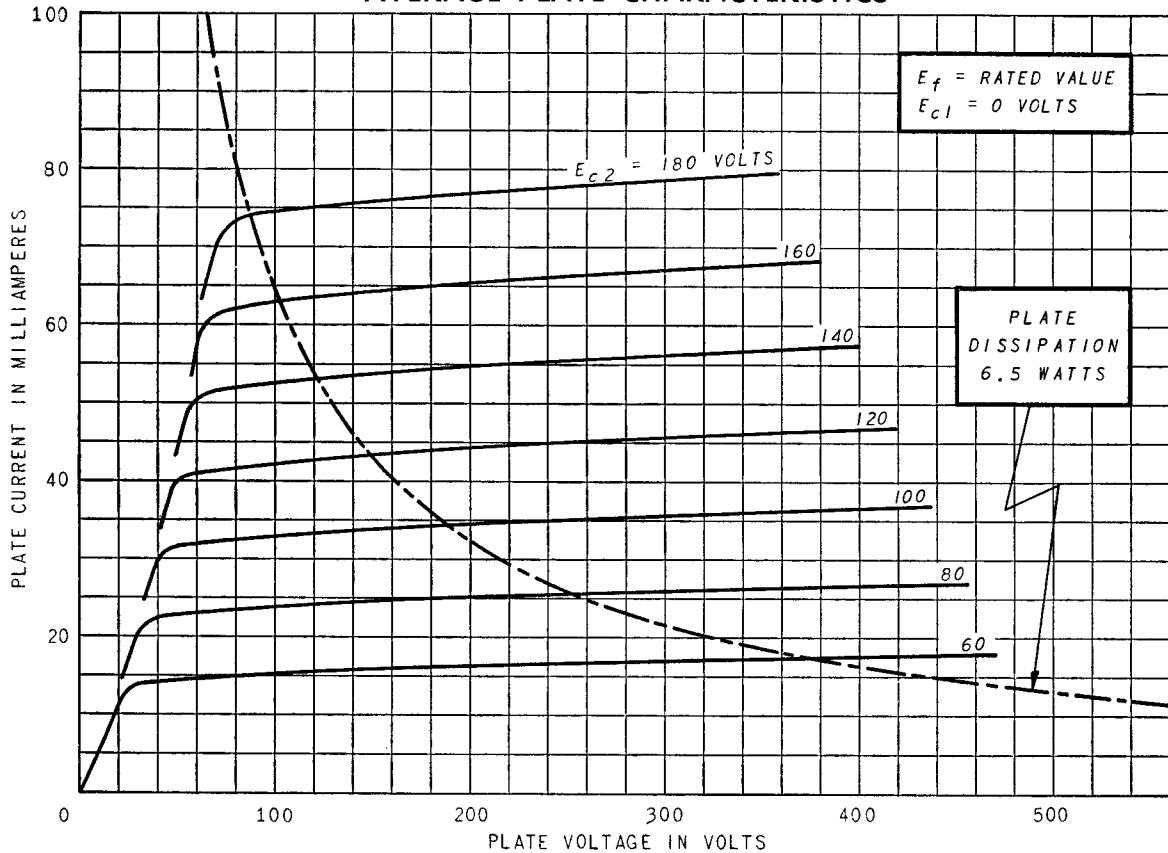

# AVERAGE PLATE CHARACTERISTICS

**12BY7-A**

ET-T943

Page 3

6-55

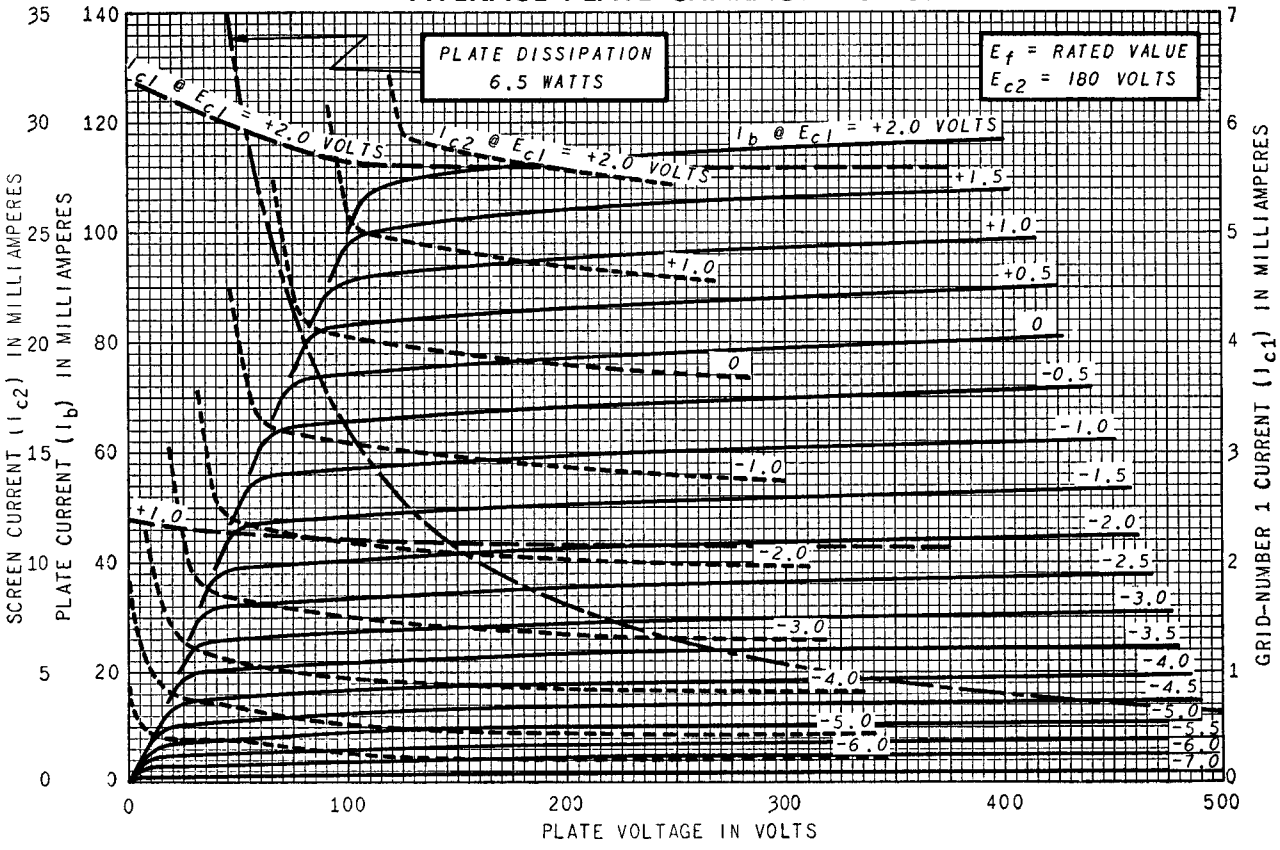

# AVERAGE SCREEN CHARACTERISTICS

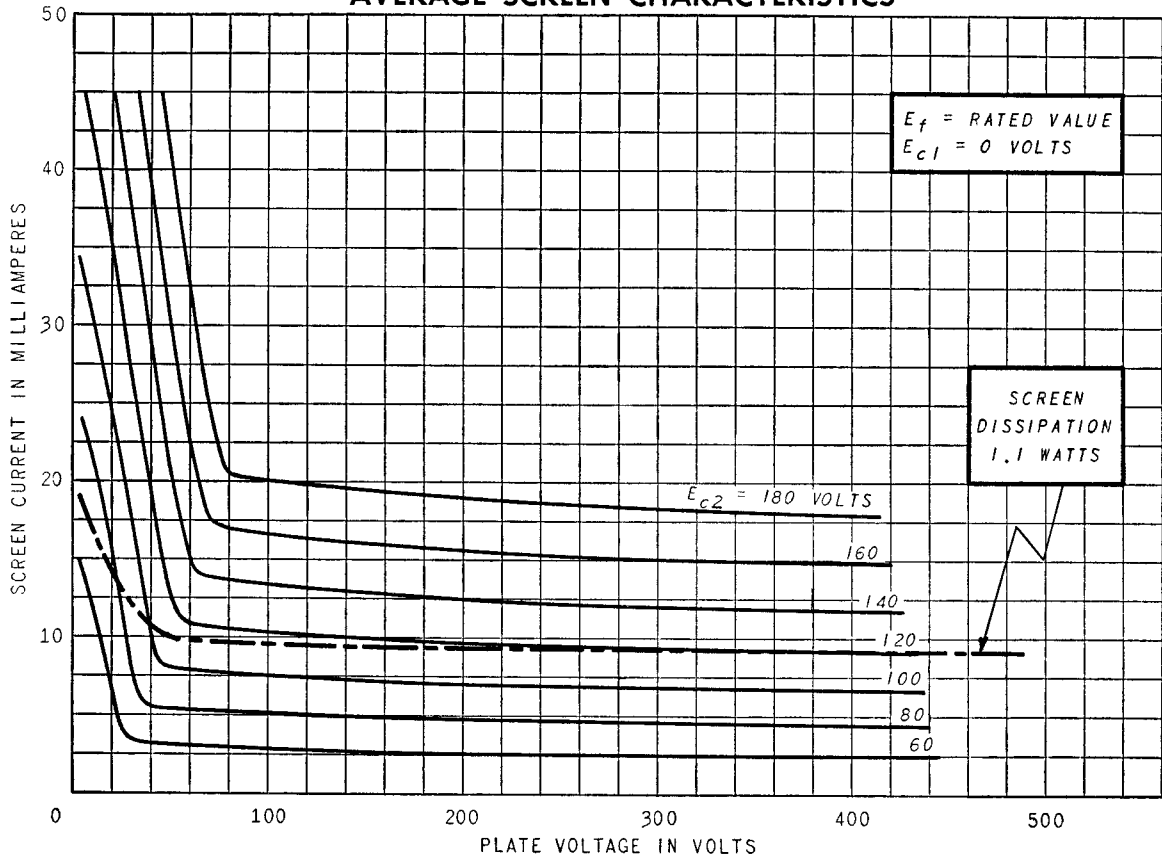

AVERAGE TRANSFER CHARACTERISTICS

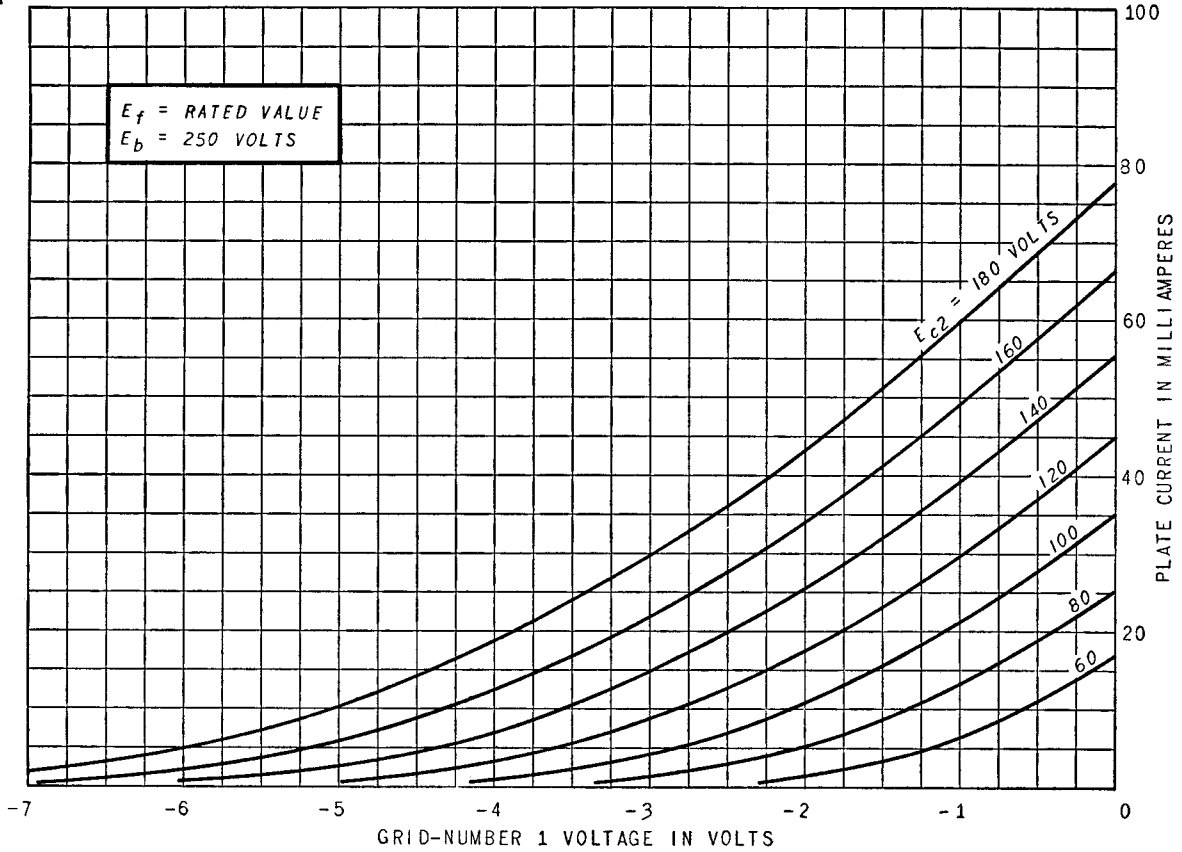

AVERAGE TRANSFER CHARACTERISTICS

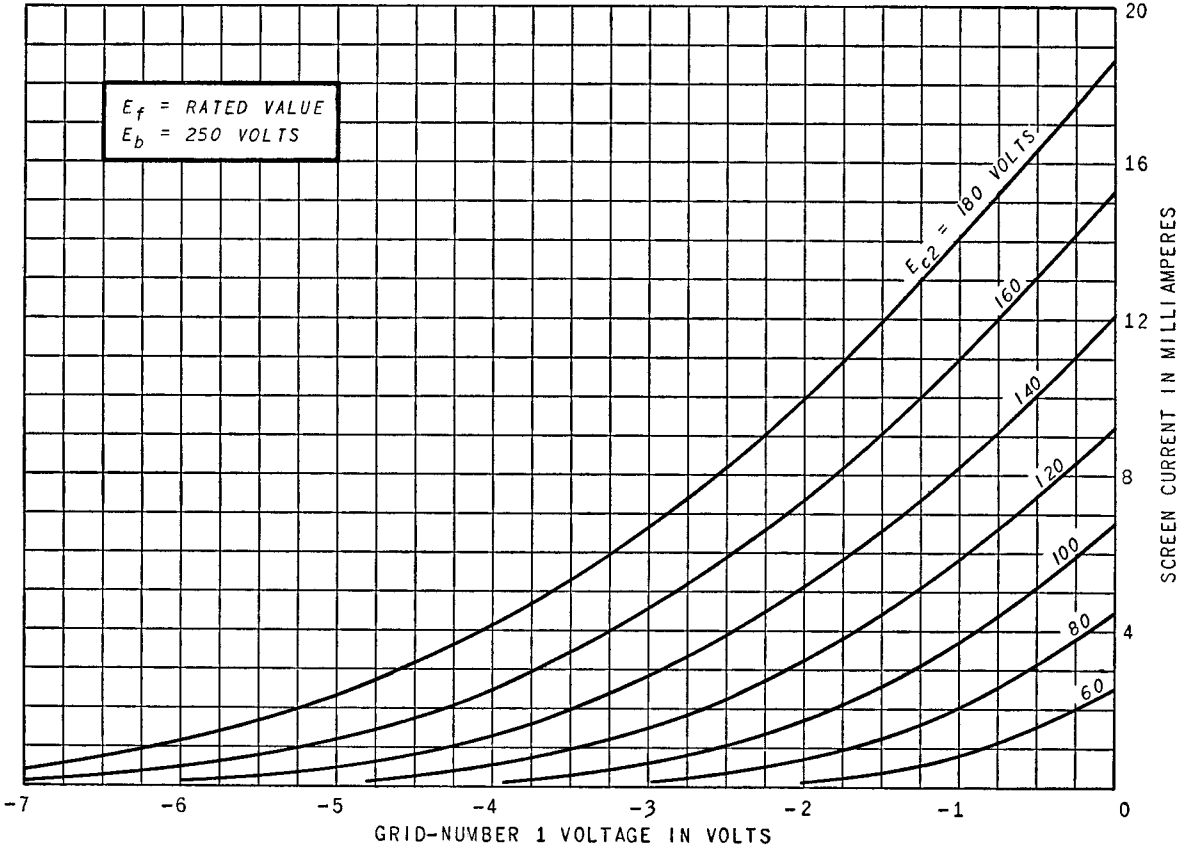

### AVERAGE TRANSFER CHARACTERISTICS

