



6BQ7-A—4BQ7-A—5BQ7-A

TWIN TRIODE

FOR VHF CASCODE AMPLIFIER APPLICATIONS

6BQ7-A
4BQ7-A
5BQ7-A
 ET-T852B
 Page 1
 12-56

DESCRIPTION AND RATING

The 6BQ7-A is a miniature, medium-mu twin triode primarily designed for use as a cascode, radio-frequency amplifier in very-high-frequency television tuners. In this application, its performance is characterized by high gain and low noise figure. An internal shield provides isolation between the two triode sections.

Except for heater ratings, the 4BQ7-A and 5BQ7-A are identical to the 6BQ7-A. In addition, as a result of their controlled heater warm-up characteristic, they are especially suited for use in television receivers that employ series-connected heaters.

GENERAL

ELECTRICAL

Cathode—Coated Unipotential

	4BQ7-A	5BQ7-A	6BQ7-A	
Heater Voltage, AC or DC	4.2	5.6	6.3	Volts
Heater Current	0.6	0.45	0.4	Amperes
Heater Warm-up Time*	11	11	Seconds
Direct Interelectrode Capacitances†	Section 1		Section 2	
Grid to Plate	1.2		1.2	$\mu\mu\text{f}$
Input	2.6		$\mu\mu\text{f}$
Output	1.2		$\mu\mu\text{f}$
Heater to Cathode	2.6		2.6	$\mu\mu\text{f}$
Plate to Plate, maximum	0.01	$\mu\mu\text{f}$
Plate (Section 2) to Plate and Grid (Section 1), maximum	0.024	$\mu\mu\text{f}$
Plate to Cathode	0.12		0.12	$\mu\mu\text{f}$
Grounded-Grid Input	5.0	$\mu\mu\text{f}$
Grounded-Grid Output	2.2	$\mu\mu\text{f}$

MECHANICAL

Mounting Position—Any
 Envelope—T-6½, Glass
 Base—E9-1, Small Button 9-Pin

MAXIMUM RATINGS

DESIGN-CENTER VALUES, EACH SECTION

Plate Voltage	250§	Volts
Plate Dissipation	2.0	Watts
DC Cathode Current	0.20	Milliamperes
Heater-Cathode Voltage		
Heater Positive with Respect to Cathode		
DC Component	100	Volts
Total DC and Peak	200	Volts
Heater Negative with Respect to Cathode		
Total DC and Peak	200§	Volts
Grid Circuit Resistance	0.5	Megohms

BASING DIAGRAM

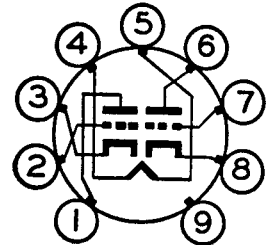

RETMA 9AJ

TERMINAL CONNECTIONS

- Pin 1—Plate (Section 2)
- Pin 2—Grid (Section 2)
- Pin 3—Cathode (Section 2)
- Pin 4—Heater
- Pin 5—Heater
- Pin 6—Plate (Section 1)
- Pin 7—Grid (Section 1)
- Pin 8—Cathode (Section 1)
- Pin 9—Internal Shield‡

‡ It is recommended that pin 9 be grounded.

PHYSICAL DIMENSIONS

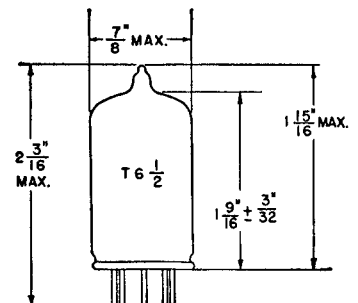

RETMA 6-2

GENERAL ELECTRIC

Supersedes ET-T852A, dated 1-56

CHARACTERISTICS AND TYPICAL OPERATION**CLASS A₁ AMPLIFIER, EACH SECTION**

Plate Voltage	150	Volts
Cathode-Bias Resistor	220	Ohms
Amplification Factor38	
Plate Resistance, approximate5900	Ohms
Transconductance6400	Micromhos
Plate Current9.0	Milliamperes
Grid Voltage, approximate		
I _b = 100 Microamperes	-6.5	Volts

* The time required for the voltage across the heater to reach 80 percent of its rated value after applying 4 times rated heater voltage to a circuit consisting of the tube heater in series with a resistance equal to 3 times the rated heater voltage divided by the rated heater current.

† With external shield (RETMA 315) connected to pin 9.

§ When the tube is used as a cascode amplifier and the two sections are connected in series, this voltage may be as high as 300 volts maximum under cutoff conditions.

AVERAGE PLATE CHARACTERISTICS

CASCODE CONNECTION

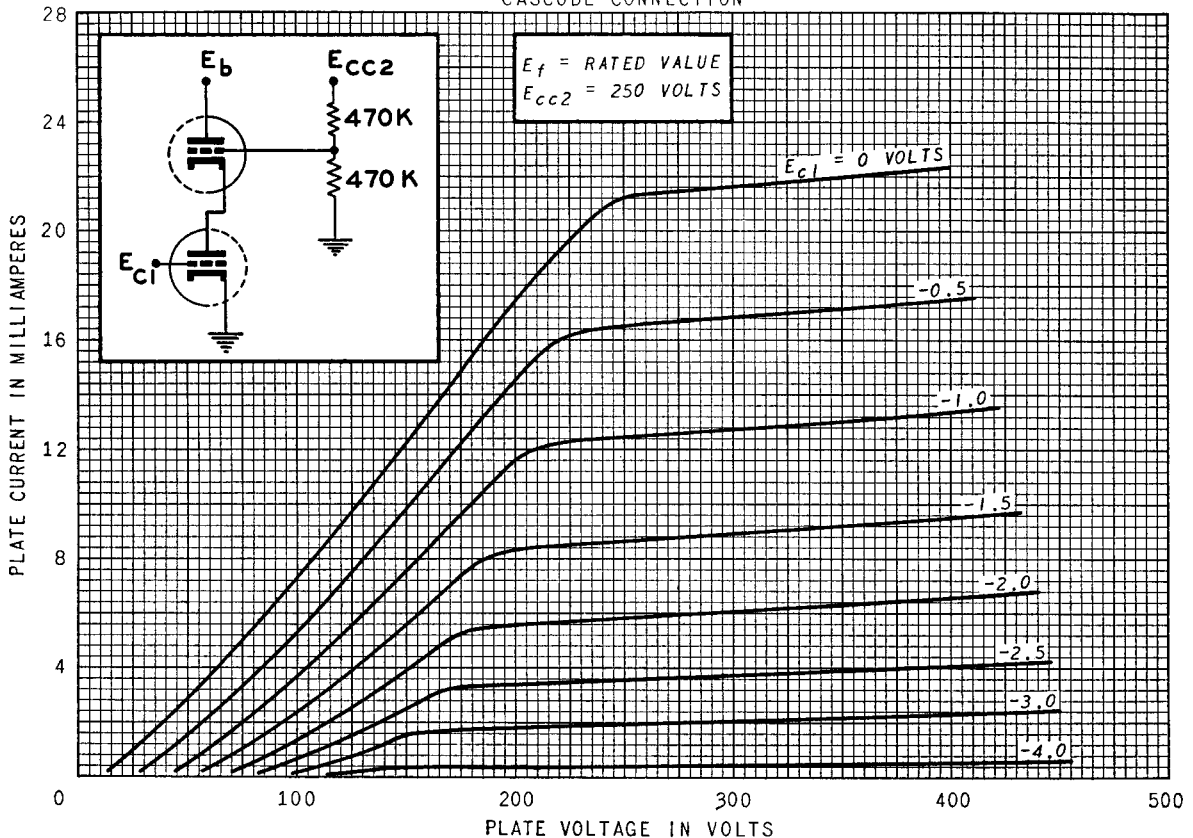

AVERAGE PLATE CHARACTERISTICS
 EACH SECTION

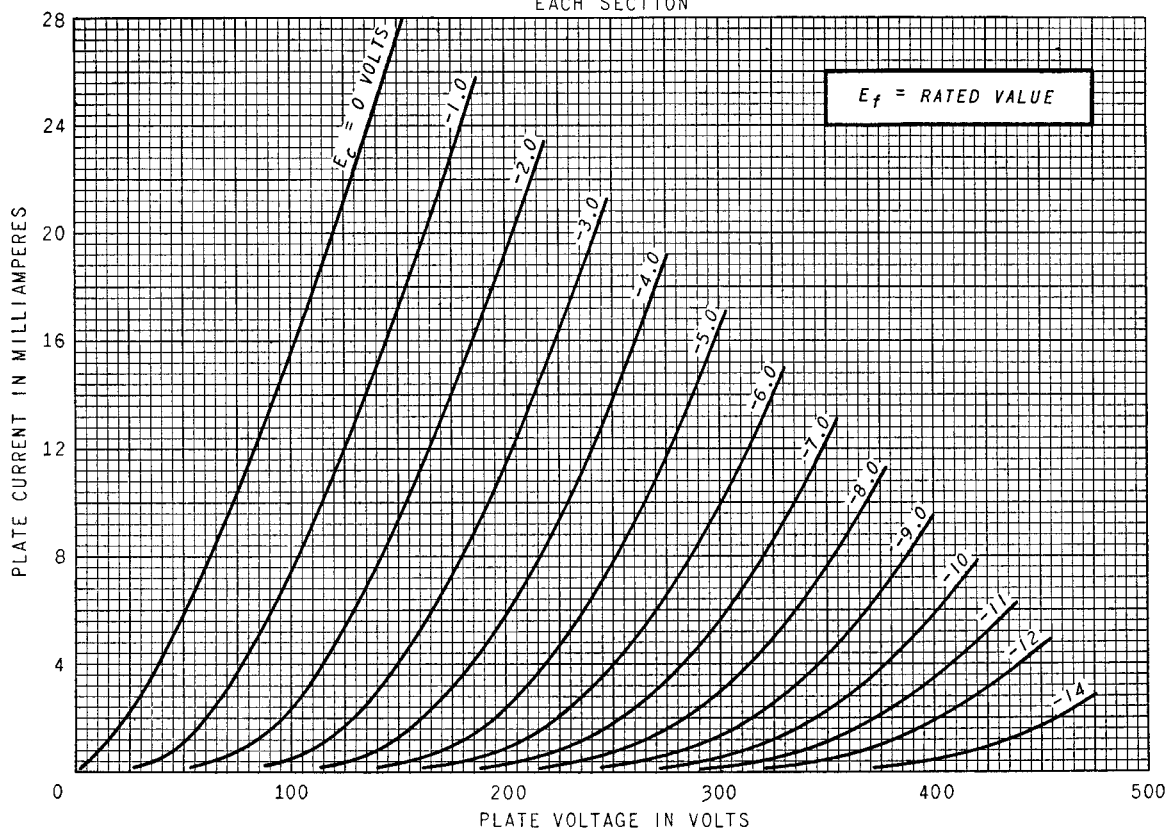

AVERAGE PLATE CHARACTERISTICS
 EACH SECTION

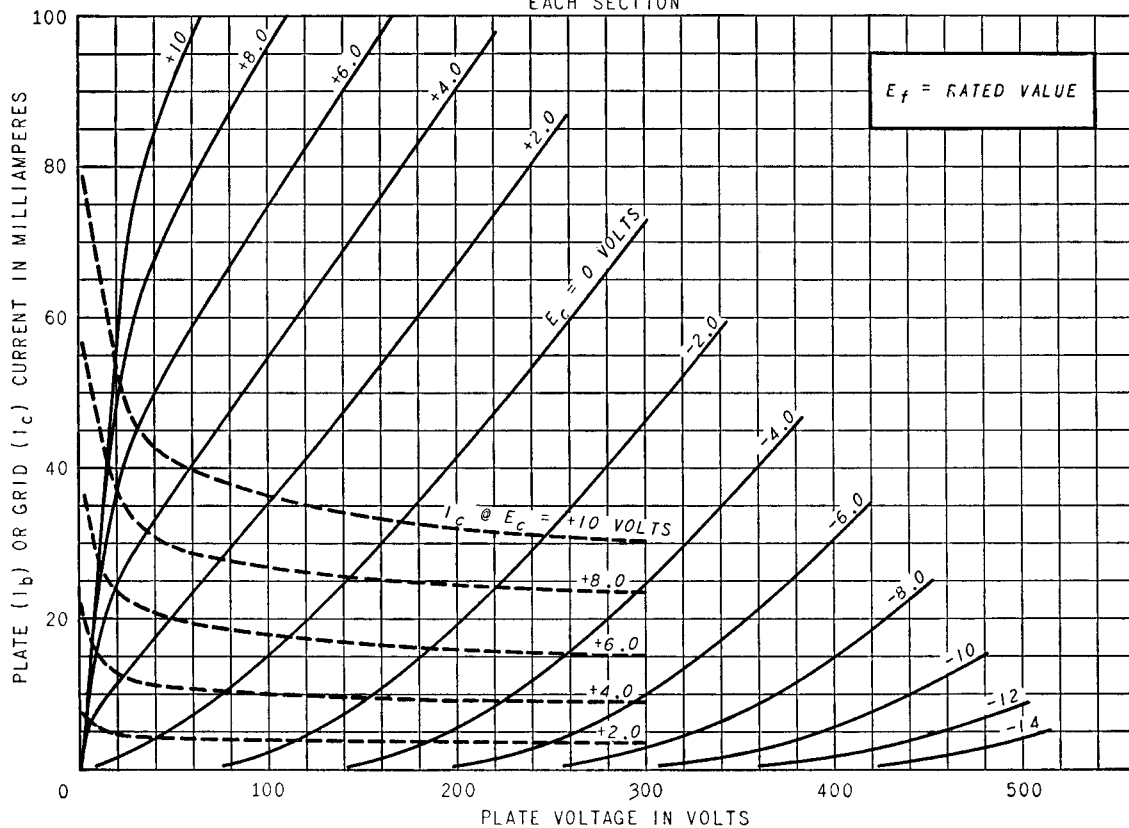

AVERAGE CHARACTERISTICS

EACH SECTION

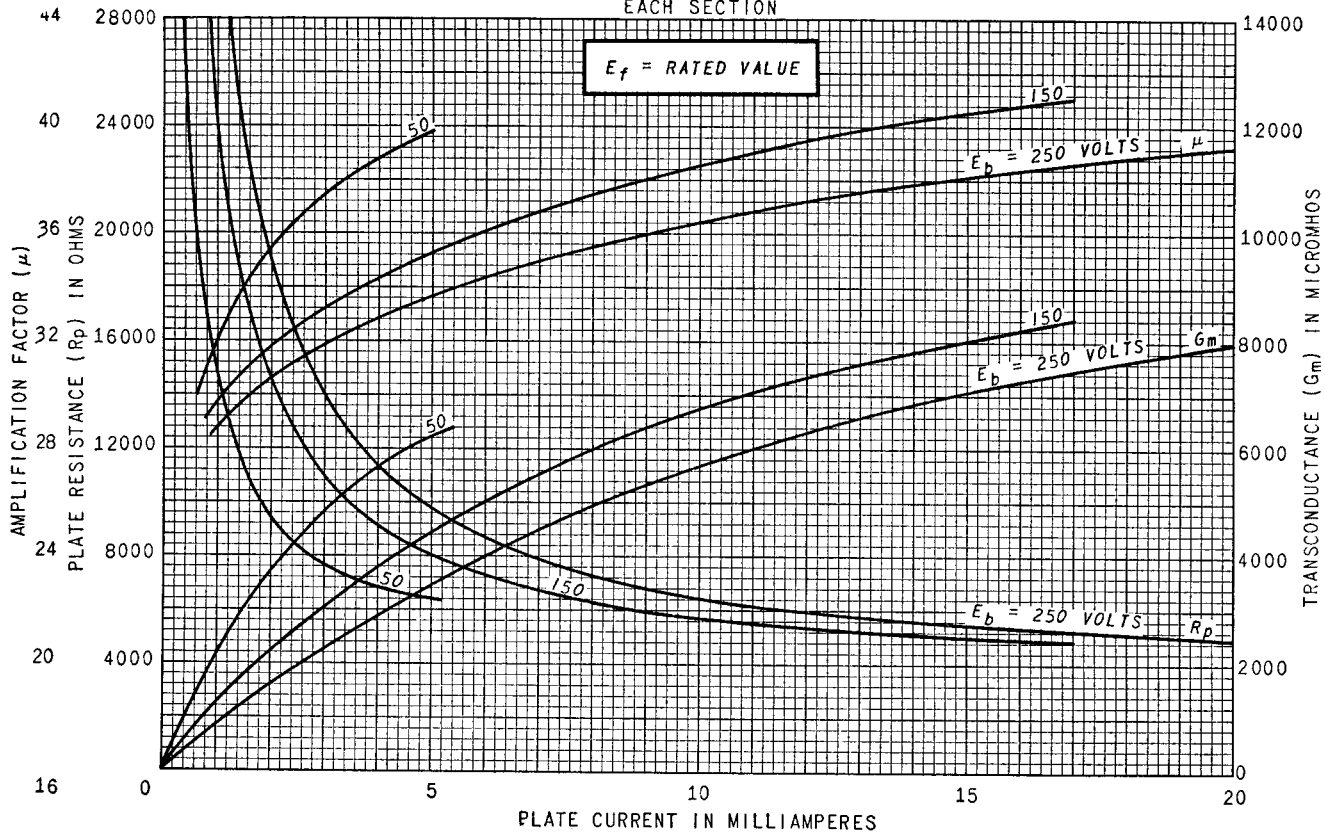

AVERAGE TRANSFER CHARACTERISTICS

EACH SECTION

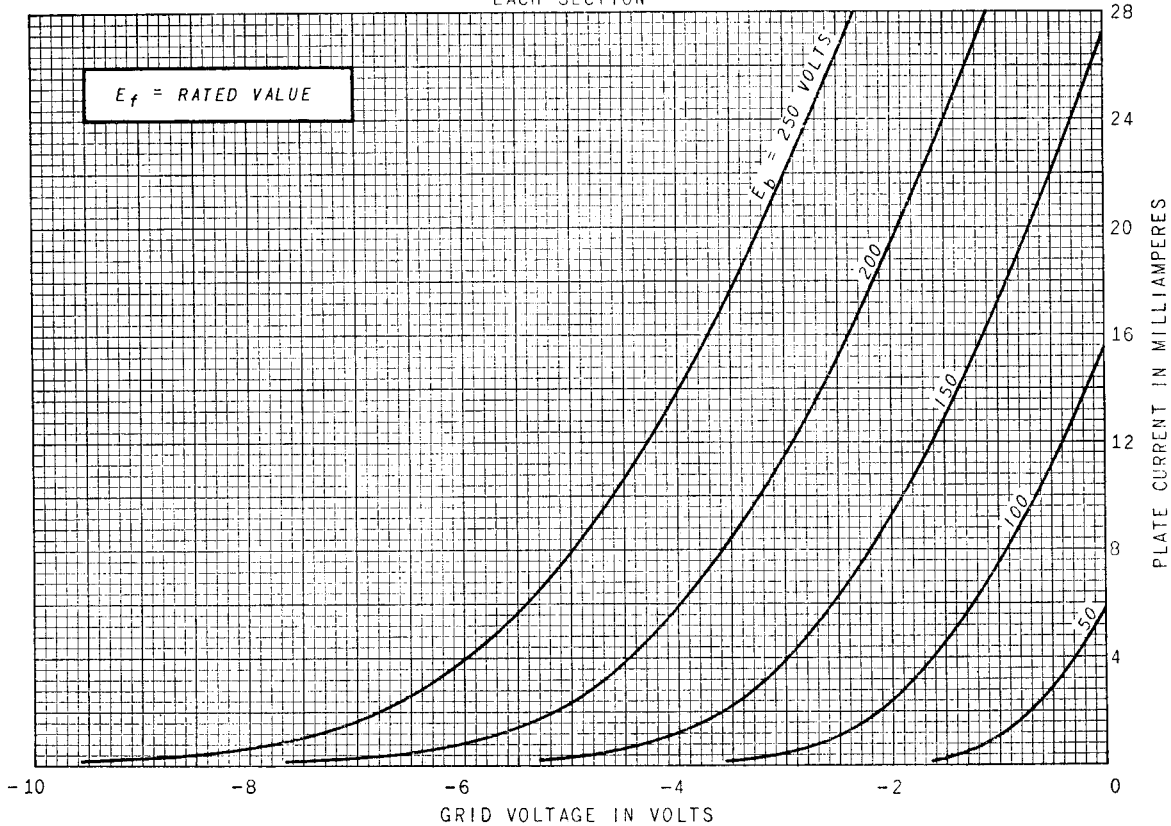

AVERAGE TRANSFER CHARACTERISTICS

CASCADE CONNECTION

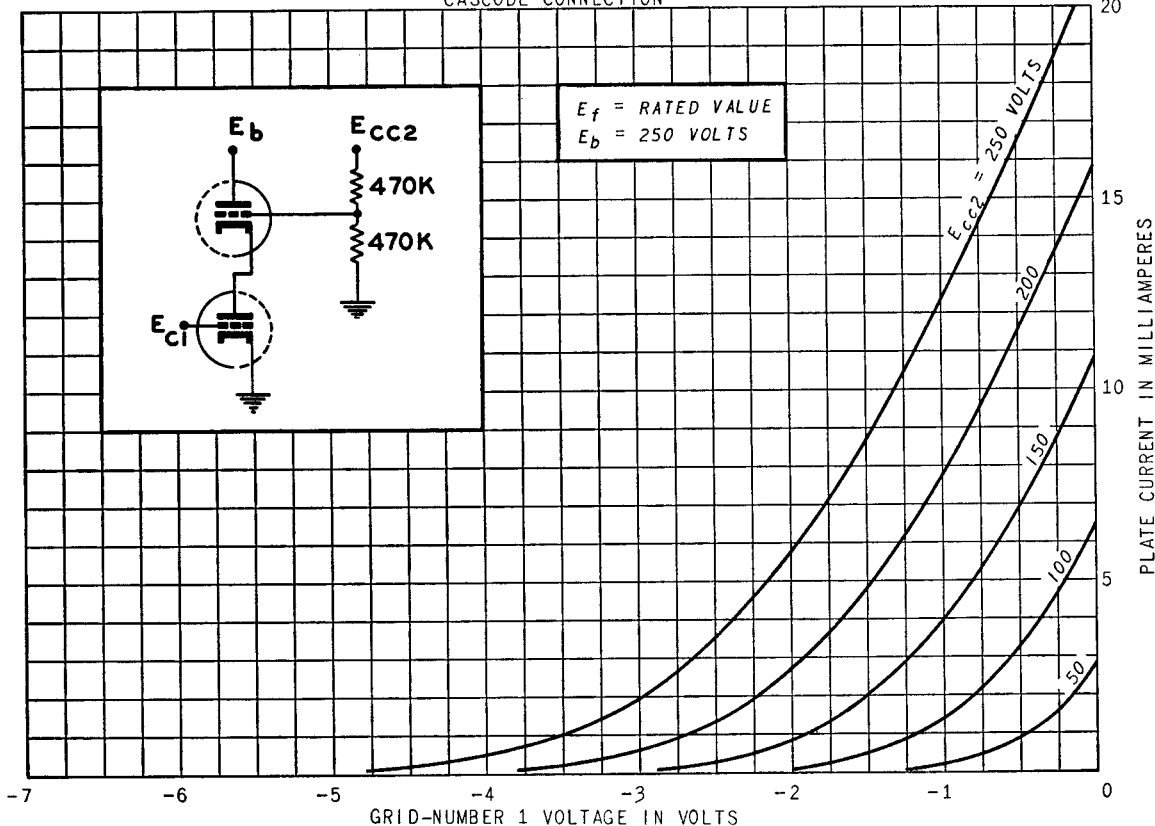

AVERAGE TRANSFER CHARACTERISTICS

CASCADE CONNECTION

