

PG 506

# SERVICETEKNOTES

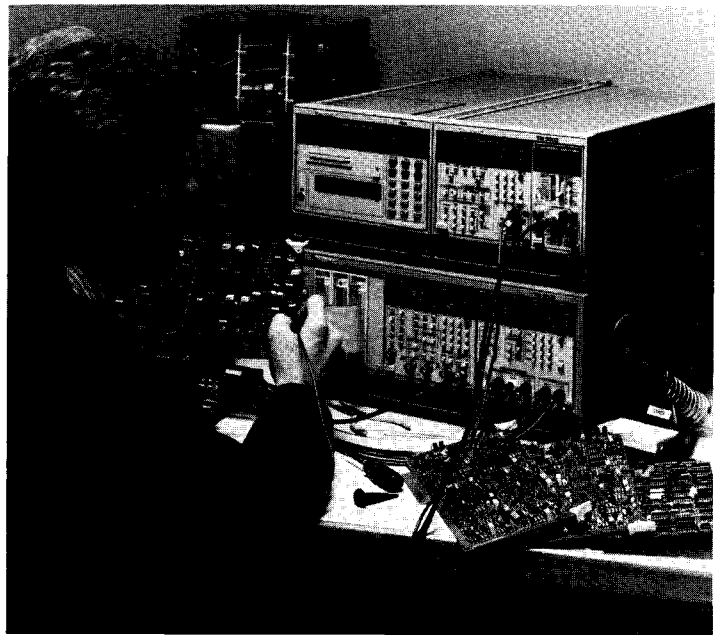
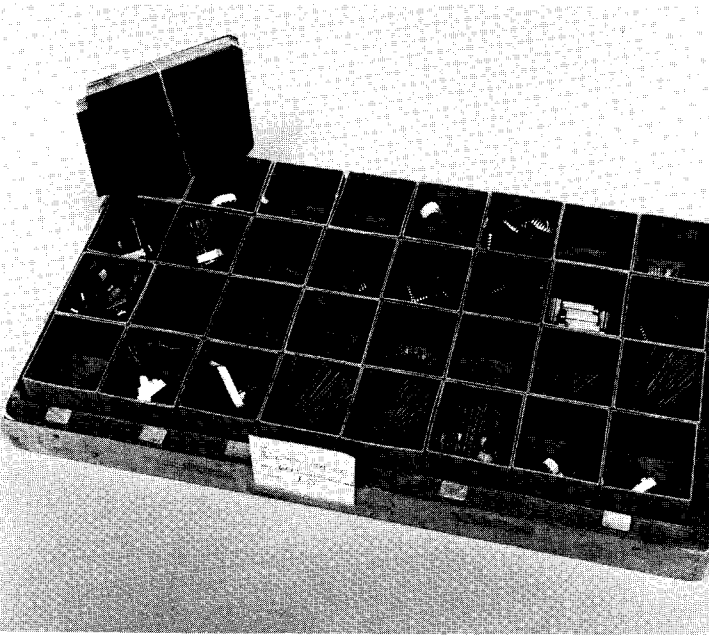
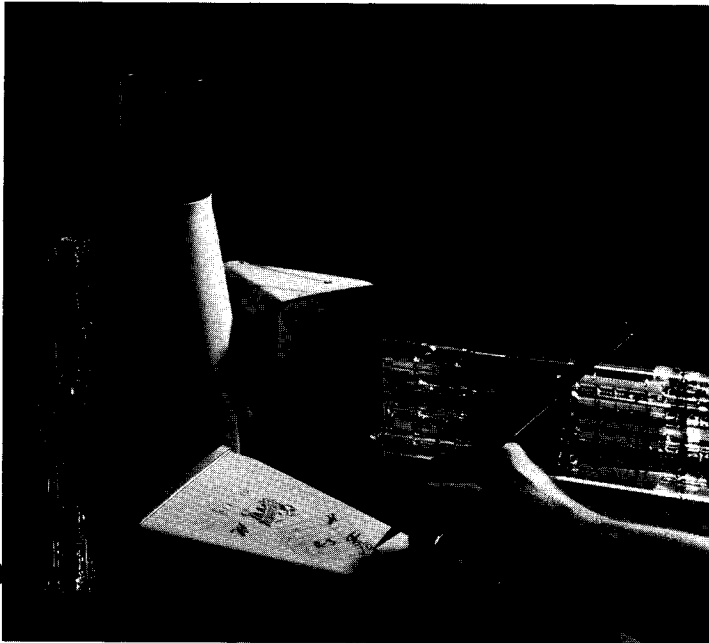

## TABLE OF CONTENTS

DC510/DC5010 X5 ATTENUATOR COMPENSATION AFFECTS RISE TIME MEASUREMENTS . . . .	1
DMs DC VOLT ZERO ADJUSTMENT . . . . .	1
DM502A S1216 REPLACEMENT. . . . .	1
PG506 CAPACITOR C20 FAILURE . . . . .	1
S3200 CLKRCL C085 REQUIRES SPECIAL ADAPTERS . . . . .	2
S3200 DATAPK COMMAND CHANGE . . . . .	2
TV PRODUCT MANUAL REVISIONS . . . . .	2
380/381 BATTERY PACK FEET . . . . .	2
520A BLOCKING OSCILLATOR OPERATION. . . . .	3
69M00/69M01/69M10 VERTICAL SYNC JITTER. . . . .	3
606(A,B)/608 CARBON FILM RESISTORS FAIL . . . . .	4
608 Z-AXIS CHANGE 52923 . . . . .	4
670 SERIES VERTICAL LINES . . . . .	5
1240 PROBE GUIDE DOOR REMOVED . . . . .	5
1410 REMOTE CONNECTOR, J41, HARDWARE. . . . .	5
1440 I3B NOISE IMMUNITY . . . . .	6
1740 SERIES BATTERY OPERATION PROBLEM . . . . .	6
1740 SERIES FIELD CARRYING CASE . . . . .	6
1910 +5 VOLT SUPPLY FAILURES. . . . .	6
1980 TO 405X SERIES PROGRAM . . . . .	7
2236 LOW VOLTAGE POWER SUPPLY FET . . . . .	7
4024/4025/4025A/4027/4027A PRINTS MULTIPLE CHARACTERS . . . . .	7
4115B FET REPLACEMENT ON VIDEO AMPLIFIER. . . . .	7
4115B UNABLE TO DEGAUSS DISPLAY OR ADJUST PURITY. . . . .	8
4115B/4632/4634 ELIMINATING BLACK BOUNDARIES FROM COPIES. . . . .	8
4115B/4691 HOW TO GET A LARGER COPY ON "B" SIZE PAPER . . . . .	8
4611/4612 F1001 FUSE FAILURES . . . . .	9
4623/4631/4632 NEW PROCESSOR MAINTENANCE KIT. . . . .	10
4631/4632/4633A/4634/4663 OPTOCOUPLER CHANGED . . . . .	10
4631/4632/4634 CONTROL BOARD CHANGE 52768 . . . . .	11
4641/4641-1/LP8200 PRINTER MECHANISM DIFFERENCES. . . . .	12
4642/4642-1 PAPER FEED GEAR MOD #52817. . . . .	14

TABLE OF CONTENTS (CONT.)

4691 AIR PUMP ADJUSTMENT PROCEDURES . . . . .14  
4691 INK JET HEAD SCREWS (PURGE). . . . .14  
4691 LOW INK LEVEL DETECTION ADJUSTMENT CORRECTION. . . . .14  
4691 TRANSPARENCY MEDIA CRITERIA. . . . .15  
4695 HEAD MAINTENANCE STATION REGISTRY. . . . .17  
8540 EPROM CHANGE TO 27128'S. . . . .17  
067-0886-XX INSTRUCTION MANUAL, 070-3530-00 . . . . .18  
067-0900-00/01 "SEQUENCE" TEST APPEARS TO HANG 4054A. . . . .18

DC510/DC5010 x5 ATTENUATOR  
COMPENSATION AFFECTS RISE TIME  
MEASUREMENTS

REF: DC510, DC5010 Manual.  
Page 4-17, Step 12.

If the x5 attenuator is not adjusted properly, risetime measurements using the x5 attenuator will read incorrectly, due to peaking or roll off. To adjust the x5 attenuator use the following procedure:

- 1) Connect the Function Generator to the DC510, DC5010 CH. A input as explained in 12a of the Adjustment Procedure, Page 4-17 of the manual.
- 2) Do step 12b.
- 3) Connect a scope, with a compensated x10 probe, to pin 14 of A12U1311. Set the scope to 200mv, AC coupled and a display of 2 cycles.
- 4) Adjust AT1505 for a properly compensated square wave on the scopes display.
- 5) Repeat 1-4 for channel B, except attach the probe to U1331 pin 14 and adjust AT 1533.

W<sup>2</sup> Issue 14-1

DMS DC VOLT ZERO ADJUSTMENT

To obtain a more accurate Zero Adjustment in DC volt ranges, apply an accurate + and - 10mv, switching between the polarities, to adjust for equal voltages around Zero volts. This method will ensure a more accurate zero than just shorting the input.

W<sup>2</sup> Issue 14-1

DM502A S1216 REPLACEMENT

REF: M50043  
SN B040100

Reed switch S1216 has been replaced with a new reed switch (P.N. 260-0722-02) for greater reliability. The improved switch requires a new coil, K1216, (P.N. 108-0966-00) as the old coil is not powerful enough to reliably actuate the new switch.

When replacing either the reed switch or the coil in instruments below serial number B040100, use modification kit P.N. 050-1802-00. DM502A serial number B040100 and above can use the new parts directly.

The manufacturing line has developed a simple test for identifying a marginal reed switch. Place the meter in the Autorange mode, and apply 1000 VDC. Should any sound other than the clicking of the relays be heard, a reed switch is defective, probably S1216. A defective switch usually squeals or buzzes and should be replaced, even if the meter appears to work normally.

W<sup>2</sup> Issue 14-2

PG506 CAPACITOR C20 FAILURE

Ref: M52846  
SN: B058180

Capacitor C20 in the power supply occasionally shorts and may damage the circuit board. A higher rated part is now being used for greater reliability.

When replacing C20, use a .68, 100V capacitor P.N. 283-0179-00. This is a direct replacement for the original 4.7uf, 50V capacitor. Manufacturing has been installing the improved part in units with serial number B058180 and above.

W<sup>2</sup> Issue 14-2

S3200 CLKRCL C085 REQUIRES SPECIAL ADAPTERS

The clock generator recalibration program, C085 Version 452102 3200, calls for the use of a DC blocking adapter, part number 015-0221-00. This is a coupling capacitor (.047 micro farad) in a BNC adapter package. Also, a BNC to probe adapter, part number 013-0084-01, is required.

This latest version of CLKRCL is used with all 2943 and 2944 clock generators. The DC blocking adapter, part number 015-0221-00, requirement addresses clock generators that have been updated with the Clock Generator Standardization Modification #M45157, including those modified via the update kits, part numbers 040-1110-00 and 040-1111-00.

W<sup>2</sup> Issue 14-1

S3200 DATAPK COMMAND CHANGE

Ref. - Command Language Reference Guide 062-3315-01 Manual change C2/783

The DATAPK command will no longer format a diskpack in Tektest IV version 4.xx. In order to perform a diskpack command DKCOPY can be used to format a new diskpack. For the RL02 diskpacks, this will require a copy from DL source drive number to DL destination drive number. Once DKCOPY is complete, the diskpack will be ready for the DATAPK command which will zero and initialize the diskpack.

W<sup>2</sup> Issue 14-1

TV PRODUCT MANUAL REVISIONS

The following manuals have been printed or revised as of the dates shown:

TSG11 Instruction Manual  
070-2328-00 Revised Dec. '83

TSG12 Instruction Manual  
070-2329-00 Revised Oct. '83

TSG13 Instruction Manual  
070-2330-00 Revised Nov. '83

110-S Operators Manual  
070-4422-00  
First Printing Sept. '83

110-S Service Manual  
070-4423-00 Revised Nov. '83

520A Instruction Manual  
070-1709-00 Revised Nov. '83

528A Instruction Manual  
070-3662-00 Revised Dec. '83

69M01 Instruction Manual  
070-3743-00 Revised Nov. '83

1480 Series Instruction Manual  
(B060000 and above)  
070-2338-00 Revised Oct. '83

1980 Programmers Reference Manual  
Measurement Commands  
070-4456-00  
First Printing Dec. '83

1980 Service Manual, Vol. I  
070-2921-00 Revised Dec. '83

W<sup>2</sup> Issue 14-2

380/381 BATTERY PACK FEET

REF: 380 Instruction Manual  
P/N 070-3421-00

381 Instruction Manual  
P/N 070-3422-00

A recent input from the Field pointed out the possibility of breakage in the area of the 380 Series cabinet feet.

A possible cause for breakage in this area can be the fact that the length of the foot (P/N 348-0365-00) allows

(ARTICLE CONTINUED ON THE NEXT PAGE)

380/381 BATTERY PACK FEET (CONT.)

it to get caught on most any obstruction when the instrument is picked up.

Since this longer foot is required to allow for proper ventilation when the battery pack is installed, it will not be changed. However, in those instances where the instrument is routinely used without the battery pack, the long feet can be replaced with 4 short feet (P/N 348-0080-01).

These short feet will also be added to the 380/381 Accessories in the near future to accommodate the needs of customers that don't use the battery pack.

W<sup>2</sup> Issue 14-3

520A BLOCKING OSCILLATOR OPERATION

REF: 520A Instruction Manual  
070-1709-00

A recent call from the Field concerning the proper operation of the 520A brought out the following information:

The problem was a tendency for a portion of the calibration circles to drop out in certain positions of the phase dial when both A and B CAL were selected.

In present 520A's there is a known problem in the ability of the instrument to free-run (no signal applied). The CAL circle problem is one of the symptoms. The blocking oscillator is a key element in providing -H pulses to the rest of the instrument, and without these pulses, properly timed, a variety of problems can result including noisy luminance signals, cal circle problems, etc.

The solution, at this time, is to swap CR1143 and CR1145 (Schematic 9) or

select these two parts to achieve a ramp timing of 68usec. A mod is being proposed that will eliminate the selection requirement, and the details will be published when they are firm.

An easy check can be made to determine if problems are occurring because of the blocking oscillator.

With no signals applied, select Channel A CAL and Channel B for input. This should provide a Cal Circle, and a dot in the center of the CRT. If this dot is somewhat elongated, ramp timing problems are possible.

An additional problem causing noisy luminance signals comes from the luminance clamp generator (Schematic 6). Q691, a 151-0190-00 transistor, may not function properly if a Fairchild transistor is used in this location.

W<sup>2</sup> Issue 14-2

69M00/69M01/69M10 VERTICAL SYNC JITTER

REF: 69M00 Instruction Manual  
P/N 070-3657-00  
69M01 Instruction Manual  
P/N 070-3743-00  
69M10 Instruction Manual  
P/N 070-3744-00

An input from the Field via SAR addressed a problem with sync stability in the 69MXX when the 690SR was operated in the cross-pulse mode. Horizontal sync was distorted in the first few lines (10-16) after the post-equalization pulses.

To fix this problem, C325 on the A1A5 board near the sync separator IC, U335, was changed to a part having tighter tolerances (P/N 283-0167-00).

(ARTICLE CONTINUED ON THE NEXT PAGE)

69M00/69M01/69M10 VERTICAL SYNC JITTER  
(CONT.)

The approximate serial numbers for implementation of this mod in the manufacturing line are:

69M01	S/N B010222
69M10	S/N B010142

W<sup>2</sup> Issue 14-1

606(A,B)/608 CARBON FILM RESISTORS FAIL

Various resistors in the 606(A), 606B and 608 are exhibiting a high failure rate. They are as follows:

Product	Circuit No.	Part Number
606(A)	R770	301-0181-00
606B	R162	301-0391-00
608	R858	301-0470-00
	R879	301-0151-00
	R880	301-0221-00

W<sup>2</sup> Issue 14-2

To correct this, only the carbon composition versions of the above part numbers should be used for these applications. Use of carbon film or metal film versions of these parts should be avoided. The distinction between composition and film parts is easily seen in the illustration below.

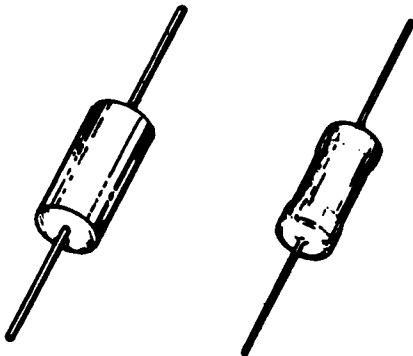

Figure 1.  
Composition and Film, respectively.

Prior to 1980, all 301-XXXX-00 and 302-XXXX-00 were carbon composition. During 1980/81, a projected shortage of composition parts required the purchase of carbon film and metal film resistors to maintain production. As a result, inventories of 301- and 302- components became mixed with both film and composition parts.

In high voltage applications, the film components have shown some distinct disadvantages. Metal film parts tend to open up without giving any visible evidence of their failure. Carbon film parts may drift in value due to migration of conductive particles (the Lorenzo effect). It is therefore advisable to avoid film resistors in any high voltage application.

608 Z-AXIS AMP CHANGE 52923

Ref: 608 Service Manual, Part Number 070-2305-00

The 608 CRT specifications exceed the range of the Z-axis amplifier. As a result, setting cutoff on the 608 may not be possible with some CRTs.

To correct for this problem, a diode is added in series with CR565 in the Z-axis amplifier. The new diode, CR566, is part number 152-0333-00 and is mounted in tee-pee fashion. The part number of the Z-axis amplifier board rolls from 670-5216-02 to 670-5216-04 with this change.

(ARTICLE CONTINUED ON THE NEXT PAGE)

608 Z-AXIS AMP CHANGE 52923 (CONT.)

Figure 1. CR566 Added.

W<sup>2</sup> Issue 14-3670 SERIES VERTICAL LINESREF: 670A/671A Instruction Manual  
P/N 070-2201-01W<sup>2</sup> Issue 14-3

Previous articles have pointed out problems with the display signals on the CRT that were due to deflection board grounding problems, such as loss of display in a small area on the CRT. There have also been several solutions published concerning the appearance of an unwanted vertical line in the Yellow Color Bar, such as selection of Q5030 or replacement of CR5020 and CR5021.

Another place to look for a possible cure for these aberrations is the screws that hold the heat sink to the deflection board. Since these screws

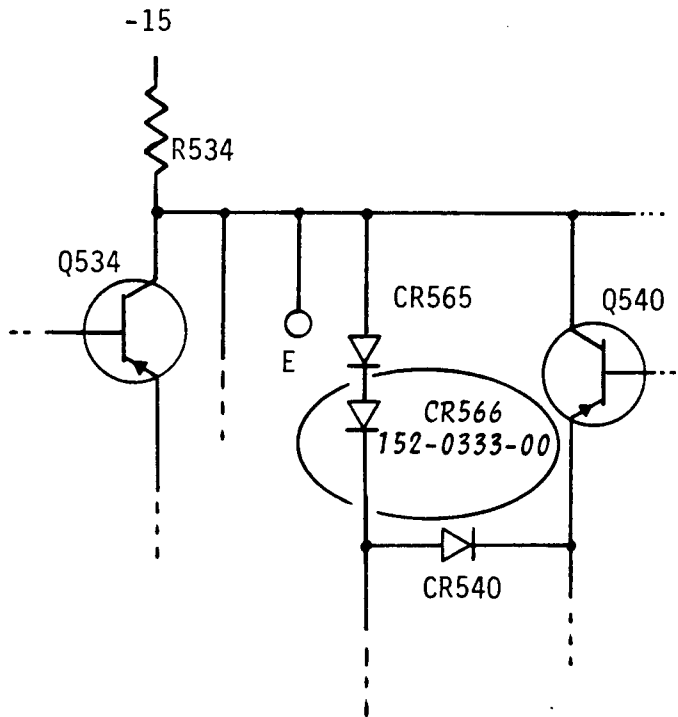
provide the ground return for the parts that are mounted on this heat sink, it is important that they be tight.

Verify the security of all mounting hardware when servicing any instrument as a normal practice. You may find that this cures a lot of problems that are very difficult to isolate otherwise.

W<sup>2</sup> Issue 14-11240 PROBE GUIDE DOOR REMOVEDReference: 1240 Preliminary Service  
Manual pp. 11-3 and 11-4;  
Fig. 1, index 8.

Early versions of the polycarbonate probe guide had a sliding door that covered the pins for the Test Pattern Generator. In later versions, the door was removed; however, the part number, 351-0696-00, was not changed. If you order the probe guide, you will get one without the door.

1410 REMOTE CONNECTOR, J41, HARDWAREREF: 1410 Instruction Manual  
070-2759-00

A hardware kit has been set up for the spring clips used on J41. The part number is 214-2476-00. This is the same kit that is used on the remote connectors in the 1900 and 1910.

W<sup>2</sup> Issue 14-3



1440 I3B NOISE IMMUNITY

REF: 1440 Instruction Manual  
070-1498-02

1440 I3B Manual Insert  
061-1448-00

A recent field inquiry was made concerning the 1440 I3B's susceptibility to noisy signals caused by such things as microwave fades.

A quick check was made on a sample unit in Manufacturing, which indicated that the 1440 I3B will go to the transmitter protect mode if the signal has about 20dB of noise. The problem is inherent in the design of the sync separator in the 1440 I3B, and in studio to transmitter links, may be difficult to overcome. However, if the microwave link in question is coming from an ENG van, the signal will most likely need to be fed through a frame synchronizer in order to be timed to the facility. The use of a high quality frame synchronizer, such as the Tektronix 100-S, that provides high noise immunity plus sync and burst insertion, may help alleviate two problems with one instrument.

W<sup>2</sup> Issue 14-2

1740 SERIES BATTERY OPERATION PROBLEM

REF: 1740 Series Instruction Manual  
P/N 070-4473-00

A modification has been made to the 1740, 1741 and 1742 to correct a D.C. operation problem.

The symptom is a tendency for the instrument to shutdown prematurely or not turn on at all when operated from a D.C. source or battery pack. It is particularly apparent when the D.C. voltage source is less than 13 volts.

The problem is caused by insufficient decoupling in the D.C. converter circuitry.

The solution is to add a 0.47ufd capacitor (P/N 283-0346-00) between the cathode of CR437 and ground. CR437 is located on the DC converter board, A6, and on schematic 10 in the product manual.

W<sup>2</sup> Issue 14-3

1740 SERIES FIELD CARRYING CASE

REF: 1740 Series Instruction Manual  
P/N 070-4473-00

The Field Carrying Case for the 1740 Series instruments is available as a single part number, 020-1241-00. This is the same case that was available from the factory as Option 2.

W<sup>2</sup> Issue 14-3

1910 +5 VOLT SUPPLY FAILURES

REF: 1910 Service Manual  
P/N 070-4523-00

Due to a problem encountered in the Field where the +5 Volt supply was shorted by a screw of excessive length, a mod has been written to change the screw part number.

Referring to Figure 1, item number 71 is being changed to P/N 212-0142-00 (2 per instrument), and item number 81 is being changed to P/N 212-0023-00 (8 per instrument).

Please inspect any 1910 that is returned for service and change these screws where appropriate.

W<sup>2</sup> Issue 14-1

1980 TO 405X SERIES PROGRAM

REF: TECHNIQUES, Vol. 7, No. 4  
Winter 1983

In order to provide mass storage (on tape) for those of you possessing a 1980 and a 405X, I put together a brief program and submitted it to the IDD Program Exchange.

This is a 405X BASIC program that allows you to use your 405X as both a terminal and a mass storage unit for your 1980 using the 405X's tape drive.

A copy of this program and supporting documentation is available by ordering P/N 062-7456-01.

W<sup>2</sup> Issue 14-3

2236 LOW VOLTAGE POWER SUPPLY FET

REF: 2236 Service Manual Schematic 7  
Q9070 N-CHANNEL FET.

The part number for the N-Channel FET that is used in the 2236 Low-Voltage Power Supply was left out of the manual. The part number is 151-1152-00. The FET is chassis mounted and connects to the circuit board at P9070 (See schematic 7 at location J8). Pin 1 of the FET is the Gate; Pin 2 is the Drain; Pin 3 is the Source.

W<sup>2</sup> Issue 14-2

4024/4025/4025A/4027/4027A PRINTS  
MULTIPLE CHARACTERS

Ref: 4024/25 Maintenance Manual Vol II  
P/N 070-2831-00  
4025A Service Manual Vol 2  
P/N 070-4168-00  
4027 Service Manual Vol 2  
P/N 070-2832-00  
4027A Service Manual Vol 2  
P/N 070-4176-00  
Corporate Modification M53174

The keyboards used on the 4024, 4025/25A and 4027/27A have a tendency to create noise spikes on the KDATA-0 line. These spikes usually increase in number over an extended time period as the keyboards are used. These spikes are created as the key contacts close. As the contacts wear (from use) multiple contact points are created which do not all close at the same time thus creating multiple spikes on the signal line.

These multiple spikes were considered during the design of the products and a time window was left to allow the signal line to settle. Later it was found that this window was not large enough so Corporate Modification M37387 was implemented. This modification however did not completely fix this malfunction. Keyboards that were used heavily eventually started to show the old symptoms.

Corporate Modification M53174 has recently been implemented to correct this malfunction by again extending the window. The modification is as follows:

4024 Processor Comm Board  
P/N 670-5258-XX  
Lift pin 13 of U20 and connect it to pin 5 of U5.

4025/25A  
4027/27A Deluxe Comm Board  
P/N 670-5056-XX  
Lift pin 14 of U375 and connect it to pin 5 of U475.

W<sup>2</sup> Issue 14-1

4115B FET REPLACEMENT ON VIDEO  
AMPLIFIER

Ref: Mod 52563

The 4115B CRT may occasionally arc internally, which might take out the FET transistor video amplifiers.  
(ARTICLE CONTINUED ON THE NEXT PAGE)

### 4115B FET REPLACEMENT ON VIDEO AMPLIFIER (CONT.)

Reliability Mod 52563 replaces the six FET's on the Video Amplifier board 670-7651-00 with six Bipolar transistors. The modified Video Amplifier board will roll to 670-7651-01.

A 050-1829-00 kit has been set up for the replacement of the 151-1158-00 FET transistors on an as needed basis. The 050 kit also consists of a number of other parts to complete the transistor conversion.

W<sup>2</sup> Issue 13-26

### 4115B UNABLE TO DEGAUSS DISPLAY OR ADJUST PURITY

REF: 640-0219-00 Display Module  
Service Manual 070-4668-00

In 4115Bs below serial number B010798 a condition may occur where the terminal is unable to degauss the display, thus making purity unacceptable. This is caused by a vendor problem with thermal resistor RT185 on the display low voltage power supply. RT185 will be found darkened or burned out.

The blue 10 ohm thermistors have been purged from stock. A new vendor has been selected. The part number will stay the same (307-0768-00) and the new component can be identified by its color (black). This new thermistor has been tested with less than 1% failure rate. Customer Service and Factory Service now have the new thermistor available.

W<sup>2</sup> Issue 14-3

### 4115B/4632/4634 ELIMINATING BLACK BOUNDARIES FROM COPIES

REF: 4632 Service Manual 070-1686-04  
4634 Service Manual U7U-3030-00

In order to eliminate the black boundary from copies made form a 4632

or 4634 interfaced with a 4115B, set up the Hard Copy Unit as follows:

1. Set SYNC on back panel to EXTERNAL.
2. Set VIDEO SWITCH to INVERT on back panel.
3. Adjust HCU for a 6"x8" image size.
4. On the 670-5723-0X timing board, set BLANKING pots R19, R20, R40 and R50 CW.  
(R numbers may differ on early 4632 timing boards)

To copy video with a dark background, press SHIFT and HARD COPY button on the 4115B keyboard. If the background is light and video dark on the 4115B display, just press the HARD COPY button on the keyboard. The resultant hard copies will have black characters or graphics with a white background and no black boundary.

W<sup>2</sup> Issue 14-1

### 4115B/4691 HOW TO GET A LARGER COPY ON "B" SIZE PAPER

Currently when you copy a 4115B to B-size paper on a 4691, you get an A-size copy on B-size paper. There is one dot on the page for every pixel on the screen, so the picture has 1280 by 1024 dots. The resolution of the 4691 for B-size copy is 2460 by 1560. It is not possible for the 4691 to apply a multiplier of two to the points received from the 4115B. The resulting picture would be 1560 by 2048 which is more points than the 4691 can handle.

### Another Approach

The following (ESC) sequences allow you to get a larger copy on B-size paper on the 4691 by restricting the area on the 4115B display to be copied. The area is restricted to half of the 4691's resolution (1230 by 780). The 4691 can  
(ARTICLE CONTINUED ON THE NEXT PAGE)

### 4115B/4691 HOW TO GET A LARGER COPY ON "B" SIZE PAPER (CONT.)

do a 2:1 duplication for a total of 2460 by 1560 points which is the 4691's maximum resolution.

Step 1: Redefine 4115B's Pixel Viewport, Viewport, Window, and Overview Window.

Setup Commands:

<(ESC)RS 0 0 1229 779>  
Set Pixel Viewport

<(ESC)RV 0 0 3931 2492>  
Set Viewport

<(ESC)RW 0 0 4095 2596>  
Set Window

<(ESC)UW 0 0 5167 4095>  
Set Overview Window

Step 2: Load file you wish to copy.  
NOTE: Any portions of the picture which have Y values greater than the new window maximum of 2596 will be clipped.

LOAD Filename

Step 3: Set up 4691 and 4115B

Attach 4115B to 4691.  
Turn on 4691.  
Put B-size paper in 4691.

On the 4115B in Setup, enter:

<HCI Color>  
Set HCInterface to color

<HCO Horizontal>  
Set HCOrient to horizontal

Step 4A: Copy screen image to 4691

<COPY SC: to HC:>  
(Copy time is approximately 5 1/2 minutes). NOTE: Pressing the 4115B hard copy key will NOT initiate a copy.

Or....

Step 4B:

Copy screen image to file. Copy or spool file to 4691.

<COPY SC: to Filename>

<COPY Filename to HC:>  
(Copy time is approximately 4 minutes).

or  
<SPOOL Filename to HC:>

The file created by the command COPY SC: to Filename is a binary file which can be copied or spooled to the 4691; the file cannot be loaded into the 4115B.

#### Additional Notes

If the 4691 (a) is not connected to the 4115B, or (b) is connected but not turned on, or (c) is connected to the 4115B, turned on, and loaded with A-size paper, the file generated by COPY SC: to Filename, when copied or spooled to the 4691, will generate A-size copy only. If you try to copy the file to B-size paper, the 4115B will generate error:

Terminal Detects Error JS01

HC: Detects data formatted for other size media.

W2 Issue 13-26

#### 4611/4612 F1001 FUSE FAILURES

Numerous reports have been received of failed line fuses in 220 volt versions of 4611/4612 products. In some instances, the cause has been found to be a 110 volt fuser assembly in the 220 volt product. Since no such failures have been encountered in Manufacturing, it is suspected that customers may be

(ARTICLE CONTINUED ON THE NEXT PAGE)

4611/4612 F1001 FUSE FAILURES (CONT.)

attempting to convert 110 volt products to 220 volts without changing the fuser assembly.

To determine which fuser is in a given product, measure the fuser element's resistance. The 110 volt fuser, part number 119-1170-00, has a resistance of about 60 ohms. The 220 volt fuser, part number 119-1349-00, has a resistance of about 220 ohms.

The part number of the 220 volt fuser assembly was mistakenly omitted from the electrical parts list in earlier 4611 and 4612 service manuals. These manuals are now being corrected to include the 119-1349-00 part.

W<sup>2</sup> Issue 14-3

4623/4631/4632 NEW PROCESSOR MAINTENANCE KIT

Ref: 062-2933-02 Processor Maintenance Kit Data Sheet

A new maintenance kit is available for rebuilding the 640-0503-0X processor used in the 4623, 4631 and 4632 dry silver copiers. This new kit, part number 003-0791-01, replaces both the 003-0791-00 and 003-0792-00 kits. It contains:

Qty	Part Number	Description
1	062-2933-02	Data Sheet
1	214-1940-03	Ejector Roller
1	214-1969-01	Heater Belt
8	214-2279-00	Oil Wicks
8	401-0316-00	Plastic Bearings
1	401-0346-00	14 Tooth Spur Gear

W<sup>2</sup> Issue 14-3

4631/4632/4633A/4634/4663 OPTOCOUPLER CHANGED

REF: M46081

The optocoupler, p.n. 156-0417-00, used on the dry silver copier "stepper wheel" and as X and Y-axis limit sensors on the 4663 was discontinued by the manufacturer. A replacement has been selected and part numbered 156-0417-01. The vendor's p.n. is K-2136.

For the 4663, the part is a direct replacement mechanically and electrically. However, the polarity marking on the new optocoupler consists of only a white spot. Orient the new part so the white spot is on the same side as the "D+" (light detector) side of the old optocoupler.

On dry silver copiers (except 4635), the LED drive current must be increased to obtain reliable performance with the new optocoupler. The current limiting resistor (usually 1K) may already be changed on a copier of very recent manufacture.

The required resistor value is 680 ohms, 1/2 w, 5%, p.n. 301-0681-00. It is located on the Control board and designated as follows:

Product	Component No.
4631, 4632, 4634	R17
4633A (std.)	R41
4633AJE, 4633A, Mods VA/VB/VC and 4633AJR	R133*

\*Schematic may erroneously show the value of R133 as 330 ohms.

(ARTICLE CONTINUED ON THE NEXT PAGE)

**4631/4632/4633A/4634/4663 OPTOCOUPLER CHANGED (CONT.)**

The resistor change rolls the part number suffix of Control boards as follows:

- 670-5770-04 to -05 (4631/4632/4634)
- 670-4599-08 to -09 (4633A std.)
- 670-6393-02 to -03 (4633AJE/4633A Mods JL/JN)
- 670-7763-00 to -01 (4633A Mods VB/VC)
- 670-7710-00 to -01 (4633A JR)

**Note:** The resistor change on a new circuit board will not harm an earlier type optocoupler nor degrade its performance.

The figures and table below show proper wiring and orientation for dry silver copiers.

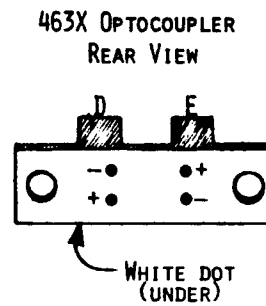

Fig. 1

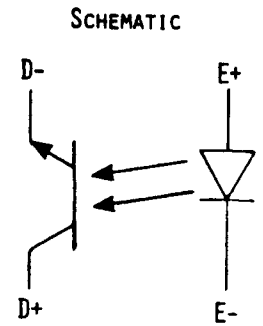

Fig. 2

W2 Issue 14-2

**4631/4632/4634 CONTROL BOARD CHANGE 52768**

- REF: 4631 Service Manual  
 P/N 070-1831-02  
 4632 Service Manual  
 P/N 070-1686-04  
 4634 Instruction Manual  
 P/N 070-3636-00

Engineering change 52768 reduces the idle speed of the 4631, 4632 and 4634 products. This change is primarily to reduce the products' noise at idle, but extended motor life is also expected. Resistor R260 on the control board is reduced from 10k ohms to 510 ohms. The new part number for R260 is 315-0511-00. The part number of the control board rolls from 670-5770-05 to the -06 level.

W2 Issue 14-3

PRODUCT	OPTOCOUPLER WIRING ORIENTATION (REAR VIEW)	
4631/4632 OLD	9-7	9-3
	9-6	9-8
4631/4632 NEW	7-N	3-N
	6-N	8-N
4633AJE 4633A Mods VA/VB/VC	Ø-N	Ø-N
	9-17	9-18
4634	Ø-N	9-3
	9-6	Ø-N
4633AJR 4635	Ø-N	Ø-N
	9-14	9-15

4641/4641-1/LP8200 PRINTER MECHANISM DIFFERENCES

Reference: 4641/4641-1 Service Manual, p.n. 070-2111-00  
 LP8200 Service Manual, p.n. 070-2364-00  
 Mod #51636

The 4641/4641-1/LP8200 is an OEM product that Tektronix purchases from Digital Equipment Corporation (LA-180). Until it was brought to our attention, we were unaware that DEC had modified the printer mechanism assembly. Furthermore, we are not able to establish a serial number break for the printer mechanism modification, because DEC has been shipping to Tektronix from a mixed stock of old and new version printers. The following drawing and parts list should be used in conjunction with the service manual when servicing the newer version printer.

The parts list only covers the parts that were affected by DEC's modification. Refer to the service manual to find part numbers for parts that were not changed. The parts affected by the change are not interchangeable between older and newer version printers. It is not recommended that these parts be purchased for local stock, they should only be ordered on an as needed basis.

Newer Version Printer Mechanism Parts

<u>Index*</u>	<u>DEC Part Number</u>	<u>Tek Part Number</u>	<u>Description</u>
28	74-18137-00	118-3416-00	Clamp, Shaft 4641
29	90-06037-01	118-3417-00	Screw, Phil Pan HD #8-32x.38
30	74-18138-01	-----	Retainer, Shaft 4641
43	74-11816-00	118-3419-00	Spring, Carriage Bumper 4641
47	90-09578-00	-----	Spring, Compression 4641
48	74-13672-00	118-3421-00	Reservoir, Oil 4641
1	74-18142-00	118-3422-00	Plate Side, Left Hand
2	74-18142-01	118-3423-00	Plate Side, Right Hand
7,57	90-09988-01	-----	Screw, Sems Hex HD #6-32x.56 Cone
22	90-09984-00	-----	Screw, Sems Phil HD #6-32x.38 Cone
24	74-18139-00	118-0087-01	Shaft, Carriage 4641
27	74-18138-00	-----	Retainer, 4641 Shaft
--	49-01174-00	-----	Oil, 4641
69	74-17937-00	118-3428-00	Bar, Print, Assembly

\*Refers to the following drawing.

(ARTICLE CONTINUED ON THE NEXT PAGE)

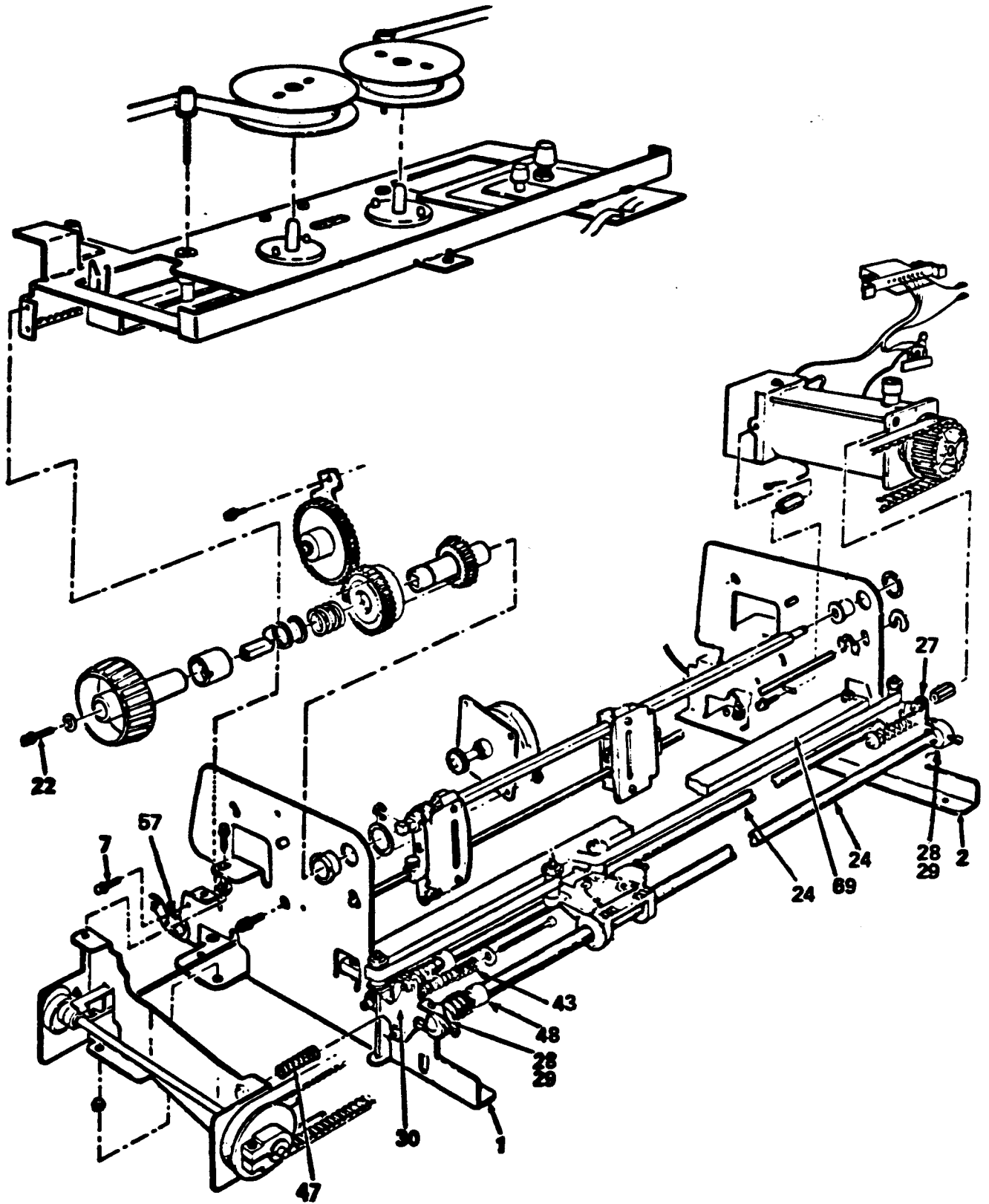

*Printer Mechanism Assembly*

**NEWER VERSION**

**W2 Issue 14-3**



4642/4642-1 PAPER FEED GEAR MOD #52817

REF: 4642/4642-1 Printer Service Manual, p.n. 070-2489-01

The 4642/4642-1 printer paper feed gear, which is part of the platen assembly (118-0293-00), can now be ordered as a separate part. The part number for the paper feed gear is 401-0598-00.

W<sup>2</sup> Issue 14-1

4691 AIR PUMP ADJUSTMENT PROCEDURES

Ref: 4691 Service Manual, P/N 070-4498-00

The following information covers the air pressure adjustment procedure for the 4691 air pump. The front cover will have to be removed to access the air pump's pressure controller. The air pressure is adjusted with the service switch in the air pump only position and the air valve open. The air pressure should be checked whenever a 4691 is being installed or serviced. The air pump is adjusted as follows:

1. Connect the air pressure gauge to one of the unused ports of the air pump. (on side of pump next to service switch)
2. Loosen set screw "B" and screw the brass nozzle fitting "A" in as far as it will go.
3. Loosen locknut "C" and adjust the needlescrew "D" until 39"±1" H<sub>2</sub>O is reached. Then lock the needlescrew "D" into position with locknut "C".
4. Screw the nozzle fitting "A" out until the pressure reaches 36"±2" H<sub>2</sub>O (should be approximately 35" for transparency media) and lock into position with set screw "B".

5. Paint set screw "B" and locknut "C" to prevent them from working loose.

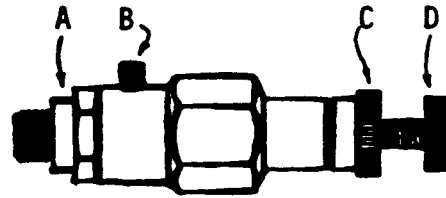

Air Pump Pressure Controller

W<sup>2</sup> Issue 14-3

4691 INK JET HEAD SCREWS (PURGE)

REF: 4691 Service Manual, p.n. 070-4498-00

The 4691 ink jet head screws (purge) are now available in a hardware kit. This hardware kit, p.n. 118-2981-00 consists of 10 screws, 5 of each size, with "O" rings. This kit is expensive

Use of the screw holder (003-0048-00) will aid in holding screws and prevent loss.

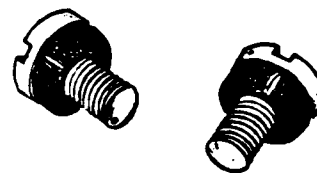

W<sup>2</sup> Issue 13-26

4691 LOW INK LEVEL DETECTION ADJUSTMENT CORRECTION

Ref: 070-4498-00, 4691 Service Manual

The 4691 low ink level detection adjustment on page 5-16 of the service (ARTICLE CONTINUED ON THE NEXT PAGE)

### 4691 LOW INK LEVEL DETECTION ADJUSTMENT CORRECTION (CONT.)

manual is incorrect as far as voltage levels and ink colors. The ink that is now used with the 4691 requires that different detection levels be used for each color of ink.

The voltages are changed as follows:

1. Yellow, VR1 is adjusted so that the voltage on R10 is .4Vdc.
2. Magenta, VR2 is adjusted so that the voltage on R16 is .8Vdc.
3. Cyan, VR3 is adjusted so that the voltage on R22 is .4Vdc.
4. Black, VR4 is adjusted so that the voltage on R28 is .7Vdc.

All 4691s that are shipped from the factory have been adjusted to the correct voltage levels.

A correction to the service manual is being made.

W<sup>2</sup> Issue 14-3

### 4691 TRANSPARENCY MEDIA CRITERIA

Ref: 4691 Transparency Instruction Manual, P/N 070-4871-00  
4691 Service Manual, P/N 070-4498-00

A quality image is harder to obtain when using transparency versus paper media. The very fact that the image is going to be projected will enlarge any imperfections in the media or the actual image itself. Extra care is needed when physically handling or storing the transparency media. The hardware and/or software has to be adjusted to meet the less forgiving requirements that transparency media imposes. Copier induced problems that may or may not be visible with paper media will be exacerbated by the use of transparency media.

A small amount of color bleeding will occur when transparency media is used. The magnitude of color bleeding that will occur on a properly functioning 4691 is approximately 1mm (.04") on boundaries between mixed color combinations (red, green, blue) and .5mm (.02") on boundaries of basic color combinations (magenta, yellow, cyan). Color bleeding is most apparent when fine detail black imagery is overlaid or borders on a mixed color image.

Excessive color bleeding can be held to a minimum by using the following measures:

1. Ensure that the ink jet heads are properly converged. Poor convergence will cause excessive color bleeding in one direction and not another.
2. Remove any entrapped gas bubbles in the ink jet heads by purging the affected head. This will reduce splatter and overspray which can be mistaken for color bleeding. Use the T.V. and/or other test patterns to determine if any entrapped gas bubbles are present in the ink jet heads.
3. Reduce the head drive voltage to the lowest acceptable level, i.e., 190 volts. Lowering the head drive voltage will lower the ink flow rate and its attendant color bleeding.
4. Adjust system air pressure to 34-35" of water. Lowering the air pressure will reduce the ink flow rate and ink droplet velocity which will reduce color bleeding and ink droplet splatter respectively. Note: The procedure for adjusting the air pressure appears in another article in this Wizards Workshop or another SOB.
5. Use dithering instead of direct overlays of basic color to produce

(ARTICLE CONTINUED ON THE NEXT PAGE)

## 4691 TRANSPARENCY MEDIA CRITERIA (CONT.)

different colors. This reduces splattering caused by an ink droplet impacting a previously deposited ink droplet of another color.

Non-uniformities will sometimes occur in solid fill areas. They take the form of small gaps between scan lines in a single (non-overlaid) color image and a slight graininess in a double (overlaid) color image. They are not obvious when they are projected and should be considered normal. Defects such as large streaks, striping, and obvious mottling are caused by problems in one or more of the ink jet heads.

The problems can be diagnosed by using the T.V. and other test patterns and then implementing the appropriate remedy. The measures for reducing color bleeding will also reduce mottling.

Transparency media is very sensitive to any contaminates being deposited on the surface of the image area prior to being printed. The oils on the surface of a persons finger tips will cause obvious defects in the printed image, if care is not exercised while handling the media. After the image is printed, the transparencies are not any more sensitive to fingerprints than any other transparent media. Defects can be caused by dust, dirt, spittle, or a multitude of other contaminates that may settle on the media before it is printed.

Scratches, streaks, smears, and other forms of physical damage in the last 1/2" of the image that was printed last (side opposite the notched corner), are usually caused by handling media that was still wet. A transparency image usually dries quickly (10 seconds), but can be damaged if it is unloaded too soon. Forgetting to place the Test Pattern Switch in the "INTL" position, which adds a 30 second drying time to the end of the copy process, will

greatly increase the probability of the image being damaged while being unloaded from the copier.

A faint track traversing the center of the image may be caused by the feed roller. Handling or touching the foam on the feed roller will contaminate it with dirt and oil that may be resident on your fingers. For this reason, extra care should be taken not to touch the foam on the feed roller. If the feed roller is contaminated and making its mark on the media, then running a few sheets of paper through the feeder will help clean the feed roller.

Periodic pauses in carriage motion may be observed when the 4691 is connected to a host. The MUX may also contribute to the problem to some degree. Periodic pauses in carriage motion will cause streaks and striations to be formed in the image during the printing process. The streaks and striations will appear as evenly spaced, non-uniformities, positioned parallel to the long axis of the transparency media. They are formed when the 4691 prints several scan lines of image and then pauses for the host to continue with the transmission of the image data. Sometimes, the streaks or striations can be corrected by disconnecting and by-passing the MUX. The best remedy is to deliver the data from the host at a rate that never leaves the 4691 waiting (software fix). Dirty carriage rails may also cause similar streaks and striation defects in the image. Cleaning the carriage rails will remedy the situation, assuring that data transmission is constant.

The previous information is provided to be used in conjunction with the appropriate Tektronix manuals.

The purpose of this article is to give information that might be of use in determining which of the defects caused by the copier are correctable and which are not. This information is provided

(ARTICLE CONTINUED ON THE NEXT PAGE)

### 4691 TRANSPARENCY MEDIA CRITERIA (CONT.)

because the 4691 copier cannot make transparencies that are satisfactory for all possible images and color combinations. However, if care is exercised, it is possible to obtain an image, when using transparency media, that will rival paper media in quality.

W<sup>2</sup> Issue 14-3

### 4695 HEAD MAINTENANCE STATION REGISTRY

Ref: 4695 Operators Manual, P/N  
070-4646-00  
4695 Service Manual, P/N  
070-4645-00

When the 4695 parks its head carriage to the extreme left of its travel (during electronic purge or power-down) the maintenance station gasket should fit well against the head itself. Misregistry of the head and gasket can jeopardize the humid atmosphere within the chamber. Some extreme cases have been seen where the gasket has touched the black or yellow orifices and wicked out the ink overnight.

There are no adjustments to correct for this occurrence. If ink is being wicked out by misregistry of the head and gasket, the maintenance station, part number 118-2942-00, must be replaced.

W<sup>2</sup> Issue 14-3

### 8540 EPROM CHANGE TO 27128's

The purpose of this article is to inform Field Service personnel of a pending change of the EPROM type used for option control firmware in the 8540.

Currently option control firmware is shipped in 2764 (8K x 8) EPROMs.

Beginning with shipments of the 80186/80188 Emulator, 8540 control firmware and diagnostics will be contained in 27128 (16K x 8) EPROMs.

A wire strap or zero ohm resistor must be added to each chip location of the System ROM board before they will accept the 27128 devices. The strap should be added as shown in the following illustration:

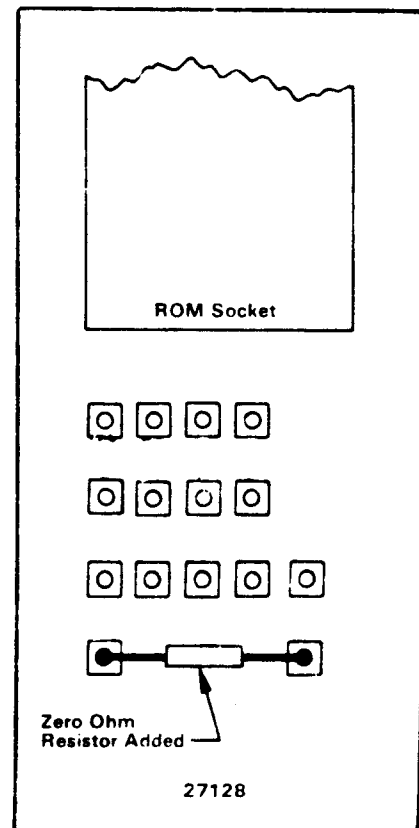

NOTE: This strap enables address line 13 to pin 26 of the corresponding ROM socket. Pin 26 of a 2764 EPROM is not connected internally; therefore a socket that has been modified to accept 27128 EPROMs will work fine with a 2764. New System ROM boards shipped from Manufacturing and Board Exchange have zero ohm resistors installed for all ROM locations.

W<sup>2</sup> Issue 14-3

067-0886-XX INSTRUCTION MANUAL,  
070-3530-00

REF: 067-0886-XX Instruction Manual  
P/N 070-3530-00

Early Test Modulators have, in a few instances, shown a possible problem where the main circuit board assembly (A1) may break loose from its standoffs. (Refer to Figure 2 in the manual, Index Numbers 83, 84 and 91.)

This problem is probably due, in part, to early standoffs that did not press into the circuit board with the desired fit characteristics. Later models were corrected.

One possible solution is to put a screw (P/N 211-0244-00) into the top of the standoff through the circuit board, thereby pressing the board back on to the standoff and insuring a secure fit.

W<sup>2</sup> Issue 14-1

067-0900-00/01 "SEQUENCE" TEST APPEARS  
TO HANG 4054A

Ref: 067-0900-00/01 Diagnostic ROM  
Pack for 4052/54 Manual Part  
Number 070-2750-00

When running the "Sequence" Test in a 4054A (or 4054F39) it appears that the 4054A hangs with all four front panel status lamps on. The usual indication of a completed test (printing "DONE" on the screen) is not displayed.

This apparent abnormality is a result of the 4054A going into the "hold" mode before the test is completed. To recover from this condition wait for the test to complete and type the "Shift" key. The 4054A will then come out of "hold" mode and print "DONE" on the screen. The "Sequence" Test runs for 2 minutes and 42 seconds. The

4054A goes into "hold" mode after approximately 2 minutes and 15 seconds. With the "A" version firmware, the Diagnostic ROM pack cannot bring the 4054A out of "hold" to print "DONE" (and therefore cannot finish its test). The LEDs on the Diagnostic ROM pack, however, do turn off when the ROM pack's firmware has finished executing the test, giving the operator a visual indication that the test is complete.

This abnormality will not be fixed.

W<sup>2</sup> Issue 14-2

The Tektronix Service Organization firmly supports a policy of assuring continued utility of products sold by Tektronix.

This publication is meant to provide technical information to the customer who has decided to maintain his own Tektronix products. It contains product servicing information and is written for the technician.

Articles are submitted primarily by Corporate Service Support & Planning Personnel thoroughly familiar with the products they support. SERVICE TEKNOTES also encourages you to submit articles for publication. If you have knowledge of a technique, procedure or idea that enables you to service your Tektronix product more effectively, write it down so others may benefit from your experience.

Articles for publication should be submitted directly to:

Tektronix, Inc.  
P.O. Box 500  
Beaverton, Oregon 97077

Attention: Janet Hemenway  
SERVICE TEKNOTES Editor

Delivery Station: 53-037

SERVICE TEKNOTES is distributed by Service Administrative Support free of charge to customers who maintain their own Tektronix equipment. A customer may be added to the distribution list by applying through his local Tektronix Sales Engineer.

---

Copyright ©1981, Tektronix, Inc. All rights reserved. Printed in U.S.A. Tektronix products are covered by U.S. and foreign patents, issued and pending. Information in this publication supersedes that in all previously published material. Specification and price change privileges reserved. TEKTRONIX, TEK, SCOPE-MOBILE, and  are registered trademarks of Tektronix, Inc. TELEQUIPMENT is a registered trademark of Tektronix U.K. Limited.

---

The Editor and staff of SERVICE TEKNOTES provide the material in this publication as a service to users of Tektronix Products. While we have tried to be diligent in assuring the accuracy of the material which we have printed, we cannot guarantee its accuracy. Neither SERVICE TEKNOTES, its editor and staff, Tektronix, Inc., nor its representatives assume any responsibility for the use of the material printed in SERVICE TEKNOTES; nor can we assume any responsibility for any errors or for the resulting effects of any errors.