



INSTRUCTION MANUAL **121**
PREAMPLIFIER **TYPE**

WIDE-BAND PREAMPLIFIER TYPE 121

SERIAL NUMBER 1324

INSTRUCTION MANUAL



MANUFACTURERS OF CATHODE-RAY AND VIDEO TEST INSTRUMENTS

Sunset Highway and Barnes Road • P. O. Box 831 • Portland 7, Oregon, U. S. A.

Phone: CYPRESS 2-2611 • Cables: Tektronix

GENERAL DESCRIPTION

The TEKTRONIX Type 121 Wide Band Pre-Amplifier is a self-contained three-stage amplifier designed primarily to increase the sensitivity of the Type 511, 511A and 511AD oscilloscopes. A maximum voltage gain of 100 is available, increasing the sensitivity of the oscilloscope to 2.5 millivolts per centimeter. A combination of step and continuous attenuators on the Tektronix Type 121 provides a complete range of sensitivity from 2.5 millivolts per centimeter to 25 volts per centimeter without the use of the attenuators on the oscilloscope. Connection between the Type 121 and oscilloscope is via a matched 93-ohm coaxial cable so that the separation of the instruments may be 100 feet or more. As in all Tektronix instruments, primary emphasis has been placed on the achievement of optimum transient response. A bandwidth in excess of 10 mc preserves the excellent rise time of the oscilloscope.

Its compactness and versatility make the Type 121 well adapted for use with other oscilloscopes or equipment employing wide-band amplification.

Characteristics

Voltage Gain

100.

Input Impedance, Direct

1 megohm — 25 μ f.

Input Impedance with 10X Probe

(See Operating Instructions.)

10 megohms — 11 μ f.

Band Pass

5 cps to 12 mc.

Maximum Output Voltage

1 v peak to peak in 93-ohm cable.

Front-Panel Power-Supply Socket

6.5 v dc at 0.2 amp.

20 to 100 v dc at 10 ma.

Power Requirement

105-125 or 210-250 volts.

50-60 cycles, 70 watts.

Dimensions

5 $\frac{3}{4}$ " wide, 11 $\frac{1}{4}$ " high, 15" deep.

Weight

18 lbs.

Finish

Panel, photo-etched aluminum with black letters.

Cabinet, gray wrinkle.

Accessories Furnished

Type COP18 power cord.

Type C121 42" 93-ohm terminated output cable.

Functions of Controls and Connections

Panel Markings	Explanation
DEFLECTION SENSITIVITY (VOLTAGE GAIN)	A four-position switch permits control of sensitivity in steps of 10 to 1. Also calibrated in terms of voltage gain. A potentiometer, calibrated over a range of 10 to 1, is used in conjunction with the four-position switch to obtain continuously variable control. Black numbers indicate deflection sensitivity (with .25 v/cm oscilloscope sensitivity), red numbers indicate voltage gain (of Type 121 only).
SIGNAL INPUT	Input connector to amplifier.
OUTPUT	Output connector, for connection to oscilloscope via 93-ohm terminated cable.
+20 V TO +100 V 10 MA +6.3 V .2 AMP ADJUST +20 V TO +100 V	Front-panel connection from power supply for vacuum-tube probe or auxiliary preamplifier. Potentiometer for adjustment of +20 v to +100 v front-panel power - supply socket voltage.
POWER	On-off switch in ac line-voltage supply.

OPERATING INSTRUCTIONS

The Type 121 may be operated in any normal indoor location, or in the open if protected from moisture. If the instrument has been exposed to dampness, it should be left in a warm room until thoroughly dry before being placed in operation.

CAUTION—To prevent excessive interior temperatures, it is important to allow adequate ventilation. Clearance should be provided on the sides, top and back of the case.

If the Type 121 is used continuously for the same application, and only one setting of the controls is required, it is advisable to periodically check the instrument at all control settings to be sure it is in normal operating condition. Operation of the controls also helps to prevent accumulation of dirt and tarnish on their contacts.

Although the components are well supported and the adjustments are very stable in setting to allow for portable operation, the Type 121 should not be subjected to excessive vibration or rough handling.

SIGNAL INPUT CONNECTION

Careful design results in an input impedance of 1 megohm shunted by $20\mu\text{mf}$, maintained for all sensitivity positions by means of frequency-compensated attenuators. This feature permits the use of an rc probe to obtain increased input impedance (at the expense of a reduction in gain), and thus reduced loading on the circuit under observation. The standard Tektronix Type P510 Input Probe (as supplied with the Type 511A Oscilloscope) may be used with the Type 121, and provides an input impedance of 10 megohms shunted by $11\mu\text{mf}$ with an attenuation of 10X.

CAUTION—Since the input capacitance of the Type 121 is lower than the Type 511A, the probe must be readjusted to obtain undistorted waveform. See the adjustment section.

If frequent interchange of probe between the oscilloscope and Type 121 is necessary, it will be desirable to obtain another Input Probe to eliminate the inconvenience of readjustment.

For applications requiring both high-impedance input and high gain, where the attenuation of an rc probe would be objectionable, an amplifier or cathode-follower probe may be employed. The front-panel power-supply socket provides 0.2 amp dc at 6.5 volts for the heater and 10 ma regulated dc at 20 to 100 volts for the plate supply of a vacuum-tube probe. Convenient adjustment of

the plate-supply voltage is provided by a front-panel potentiometer.

OUTPUT CONNECTION

The Type 121 is equipped with a cathode-follower output stage to permit connection to the oscilloscope input by means of a terminated coaxial cable. This feature allows a separation of 100 feet or more between the instruments without introducing appreciable distortion of waveform.

A 42" 93-ohm terminated output cable, equipped with UHF connectors, is supplied. Attach the red connector to the OUTPUT of the Type 121. Attach the other connector, which contains the 93-ohm terminating resistor, to the oscilloscope signal input. If additional length is required, insert a section of RG62U (93 ohm) cable between the Type 121 OUTPUT and the red connector of the supplied cable, leaving the terminated end connected to the oscilloscope input.

CAUTION—The output cable must be properly terminated to prevent reflections and consequent waveform distortion.

A special adapter for connection to the Tektronix Type 511 (predecessor of Type 511A) oscilloscope signal input, and a clip-lead adapter for connection to other equipment not fitted with UHF connectors, is available.

ADJUSTMENT OF SENSITIVITY

Normally it is desirable to set the vertical-deflection sensitivity of the oscilloscope used in conjunction with the Type 121 preamplifier at 0.25 volt per centimeter (peak to peak), and control the overall sensitivity by means of the DEFLECTION SENSITIVITY controls of the preamplifier. This will keep the output voltage required of the Type 121 within the specified 1 volt peak-to-peak value, and thus prevent overload distortion which might occur with the oscilloscope operating at lower sensitivity. Also, this method permits reading of deflection sensitivity (black numbers) directly from the preamplifier controls.

The four-position switch selects the proper networks of a two-section compensated attenuator to permit adjustment in four 10:1 ratio steps. The potentiometer provides continuously variable control over a 10:1 range for each switch position. These two controls are calibrated in DEFLECTION SENSITIVITY (black figures) and VOLTAGE GAIN (red figures). With the

oscilloscope sensitivity set at 0.25 volts per centimeter the deflection sensitivity of the preamplifier and oscilloscope combined may be read directly from the two attenuator controls. The overall deflection sensitivity will be the product of the two scale readings; e.g., with the switch set to 2.5 and the potentiometer set to 4 the overall deflection sensitivity will be $2.5 \times 4 = 10$ volts per centimeter. The product of the red-scale readings indicates the voltage gain of the Type 121 only.

CAUTION—Indicated deflection sensitivity is only approximate, due to manufacturing tolerances and aging of the tubes and other components in both the Type 121 and associated oscilloscope.

If accurate knowledge of sensitivity is required, the equipment should be calibrated against a known voltage, such as the Tektronix Type 104A square-wave generator and calibrator, by adjusting the gain of the oscilloscope until the overall sensitivity is correctly indicated by the preamplifier controls. The four-position switch may be in any position, but greatest accuracy of calibration will be obtained with the potentiometer fully clockwise.

Since the gain changes somewhat with line voltage variation, it may be desirable to supply the Type 121 from a regulating transformer when it is employed in critical applications.



CIRCUIT DESCRIPTION

AMPLIFIER

The amplifier of the Type 121, located on the upper chassis, is divided physically into two sections. One section consists of a shock-mounted assembly including the tubes and many associated components of the first, second and attenuator cathode-follower stages. The other section includes the third and output cathode-follower stages, which operate at higher signal level, and are located on the rear of the main amplifier chassis.

The wide range of deflection sensitivity (10,000:1) provided by the Type 121, requires that large amplitude signals be attenuated before they are applied to the grid of V1, in order to prevent overload distortion. This is accomplished by means of frequency-compensated rc attenuators, which are inserted by sections A and B of the DEFLECTION SENSITIVITY switch, SW1, in the .25 V/CM and 2.5 V/CM positions. The attenuation ratios are 10:1 and 100:1 respectively, and limit the peak-to-peak input signal at the grid of V1 to a 2-volt maximum for the specified 1-volt peak-to-peak maximum output. Constant input impedance for all sensitivities and accurate attenuation are assured by accurate (1%) resistors and variable capacitors. This feature permit the use of a frequency-compensated input probe to obtain reduced loading on the circuit under observation.

Another 10:1 rc attenuator is inserted between V1 and V2 by sections C and D of SW1, in all except the .0025 position.

Tubes V1 and V2 are in the first and second amplifier stages. High-frequency compensation is achieved by means of the adjustable inductors L1, L2, L3 and L4, and low-frequency compensation is provided by C15A and C20.

The sensitivity (gain) control provided by the DEFLECTION SENSITIVITY switch, SW1, consists of four 10:1 steps. To permit continuously variable control, the 500-ohm DEFLECTION SENSITIVITY potentiometer, R21, is employed to fill in between the steps of SW1. The cathode follower V3 feeds a low-impedance attenuator circuit. This is necessary to prevent stray capacitances from appreciably restricting the high-frequency response. R22 limits the maximum attenuation of this control to 10X, and thus limits the output voltage required of the previous circuits to a value well below the point of overload.

V4 is in the third stage. L5, L6 and L7 provide high - frequency compensation. Low - frequency compensation, to correct for the reactance of bypass and coupling capacitors, is obtained by means of C20. R27, a portion of V5 grid resistor,

is made variable to permit accurate adjustment of the low-frequency response.

The output cathode-follower stage, V5, permits connection to the oscilloscope (or other equipment) by means of a low-impedance output cable. This feature allows the use of a long cable between the Type 121 and associated equipment without introducing appreciable waveform distortion.

CAUTION—The output cable must be properly terminated. See operating instructions.

POWER SUPPLY

In order to make the operation of the Type 121 independent of line-voltage fluctuations over the range of 105 to 125 volts, electronically regulated direct current at 170 volts is supplied to all plate and screen circuits. Full-wave rectification is provided by V101 and V102. A filter consisting of C102A, L102 and C102B reduces ripple to a low value. The electronic regulator further reduces the ripple to about 10 millivolts peak to peak. In this circuit, the cathode of V104 is maintained at a fixed potential by the voltage reference tube, V105. Any fluctuations in the 170-volt supply are impressed on the input-section grid of the cathode-coupled amplifier of V106 via the divider, R114, R115 and R116. The fluctuation signal appears at the cathodes of V106 across the common resistor, R112, with the same polarity as at the grid. Since the grid of the output section of V106 is held at constant potential by the voltage reference tube, V105, the fluctuation signal appears, amplified but with the same polarity, across the plate load resistor, R111. This signal is applied to the grid of the amplifier, V104, via R109. Since the cathode voltage of V104 is held constant by V105, the fluctuation signal is amplified, then applied (opposite in phase) to the grid of the series regulator, V103. Thus the voltage drop across V103 is increased when the +170-volt output is high and decreased when it is low, resulting in a stabilized output voltage. The shunt resistor, R103, is employed to reduce the plate current required of V103. Potentiometer R115, labeled ADJ TO 170 V, permits accurate adjustment of the output voltage and has sufficient range to compensate for variation in tube characteristics.

To minimize the introduction of line frequency ripple at the low signal levels which may be experienced in operating the Type 121, the heaters of V1 and V2 are supplied with direct current. This is accomplished by means of a full-wave selenium rectifier, and a filter consisting of C101A, L101 and C101B.

MAINTENANCE AND ADJUSTMENT

Maintenance

REPLACEMENT OF COMPONENTS

Most of the components used in the construction of TEKTRONIX instruments are standard parts obtainable from any well-equipped parts distributor. Some of the components carrying 1% and 2% tolerances may not be so readily obtainable but may be purchased from the manufacturer at these tolerances. The remainder of the low-tolerance components are standard 10%- and 20%-tolerance parts that are checked at the factory for proper value or performance. Replacement parts are available on order from the factory at current net prices but in the case of standard parts it is probably more economical of time to purchase them locally. It is not feasible to attempt to check out low-tolerance parts or matched pairs without a reasonably large stock to choose from as the rejection percentage is quite high in many cases.

IMPORTANT: It is imperative that you get parts-ordering information from the instruction book prepared specifically for the instrument involved. The serial number of the instruction book must agree with the serial number of the instrument.

A TEKTRONIX instruction manual will usually contain hand-made changes of diagrams, parts lists, and text, appropriate only to the instrument it was prepared for. There are good reasons why this is true.

First, TEKTRONIX engineers are continually working to improve TEKTRONIX instruments. When the improved circuitry is developed or when better components become available, they are put into TEKTRONIX instruments as soon as possible. As a result of constant improvement TEKTRONIX instruments are always built as good as we can build them, but the changes caused by these improvements must frequently be entered by hand into the manual.

Second, when TEKTRONIX instruments go through our exhaustive test procedure, TEKTRONIX technicians adjust them individually to obtain optimum operation. This kind of hand tailoring occasionally requires substitution of components differing from the nominal values printed in the manuals.

Third, because of procurement difficulties, equivalent but different parts are sometimes used. Usually such parts are directly interchangeable with those originally specified. No alternate parts have been used which have adversely affected the instrument, and you were able to receive your instrument much earlier than you might have otherwise.

To assure that you will receive the correct re-

placement parts with the minimum of delay it is therefore important that you include the instrument serial number with your order, along with the instrument type and part numbers, of course. And as a further precaution, get ordering information from the instruction manual whose serial number agrees with the instrument.

Equivalent parts, supplied by the factory when the exact replacement parts ordered are not available, will be accompanied by an explanation and will be directly interchangeable in most cases.

Adjustment

CAUTION—Use only silver-bearing solder on the ceramic terminal strips and for tinning the soldering iron, if it becomes necessary to resolder.

The slots in the ceramic terminals are filled with solder containing 3 per cent of silver which is bonded to a film of pure silver fused with the porcelain glaze. Ordinary tin-lead solder absorbs the silver from the fused film to the extent that a bond can no longer be formed between the solder and the porcelain after only a few resoldering operations.

Silver-bearing solder is used in printed- and etched-circuit techniques and is therefore readily available from all principal solder manufacturers. A length of 3 per cent silver solder is included with the instrument, and is located inside at the top of the back plate.

CAUTION—The oscilloscope used in conjunction with the Type 121 must itself be in accurate adjustment before proceeding with the adjustments described in this section. Otherwise the adjustments will be set to compensate for deficiencies in the oscilloscope, and distortion will occur when the Type 121 is employed with properly adjusted equipment.

REMOVAL OF THE CASE

Set the amplifier face downward on a padded flat surface, loosen the fastener at the rear, then lift off the case.

OPERATION ON 210-250 VOLT 50-60 CYCLE LINE

The Type 121 power transformer is wound with two 117-volt primaries. These windings are ordinarily connected in parallel at the factory for 117-volt operation. If 234-volt operation is desired, remove the jumpers connecting terminals 1 to 2 and 3 to 4. Connect terminal 2 directly to terminal 3. With the line still connected to termi-



nals 1 and 4, the instrument is now ready for 234-volt operation.

ADJUSTMENT OF 170-VOLT REGULATED SUPPLY

The output of the regulated supply should be maintained within 3% of the 170-volt nominal value. Check with an accurate voltmeter and correct if necessary by adjustment of R115 (labeled ADJ TO 170 V) on the power-supply chassis. This check should always be made if the voltage-reference tube V105 is changed.

ATTENUATOR ADJUSTMENT

The compensated attenuators used in the Type 121 are the rc type in which the capacitive-divider ratio is made equal to the resistive-divider ratio, and therefore division of voltage is constant at all frequencies. Since stray capacitances represent a considerable portion of the total values, each divider is provided with a variable capacitor which permits accurate compensation.

Adjustment of the attenuator and input variable capacitors may be readily made while observing their square-wave response. A square-wave signal is faithfully reproduced when the capacitors are in correct adjustment. If the capacitive divider has a lower attenuation ratio than the resistive divider, a "spike" appears on the front corners. With high capacitive-divider attenuation, the corners are rounded. A square-wave frequency of approximately 1 kc is suitable for the time constants involved. An amplitude range of 75 millivolts to 50 volts should be available. The Tektronix Type 104A and Type 105 Square-Wave Generators may be used for this purpose.

The following procedure is recommended:

1. Loosen the fastener at the rear of the case and slide the case back 4 inches, which is sufficient to allow access to C13. Ground the case to the chassis.
2. Place an L-shaped shield of sheet metal about 3 inches wide over the top and left side of the instrument to simulate the presence of the case. Otherwise an error in adjustment may occur due to change in stray capacitance.
3. Connect the Type 121 OUTPUT to an oscilloscope set at 0.25 volt (peak-to-peak) per cm sensitivity, and set the sweep time at 2 milliseconds.
4. Connect a suitable 1-kc square-wave source to the Type 121 SIGNAL INPUT via a shielded cable.
5. Set the DEFLECTION SENSITIVITY switch (SW1) at .025 and the potentiometer (R21) at 10 (counterclockwise).

6. Adjust the square-wave generator for a 0.75-volt output. An image consisting of 2 cycles at an amplitude of about 3 cm should now appear on the oscilloscope.
7. Adjust C13 for proper waveform.
8. Remove the sheet metal shield and slide the case forward 2 inches.
9. Move SW1 to .25, increase the square-wave signal to 7.5 volts and adjust C2.
10. Move SW1 to 2.5, increase the square-wave signal to 50 volts and adjust C5.
11. Attach the P510 R-C probe (supplied with the Type 511-A-AD oscilloscope) to the Type 121 SIGNAL INPUT and connect probe to square-wave generator.
12. Move SW1 to .025, reduce the square-wave signal to 7.5 volts, set the oscilloscope sweep at 10 milliseconds, and adjust the probe capacitor.
13. Move SW1 to .25, move R21 to 1 (fully clockwise) and adjust C1.
14. Move SW1 to 2.5, increase the square-wave signal to 50 volts and adjust C4.

NOTE: If an rc probe of other than 10:1 ratio is employed, the square-wave signal amplitude should be varied accordingly.

LOW-FREQUENCY RESPONSE ADJUSTMENT

The capacitance of the electrolytic capacitors employed in the amplifier circuits of the Type 121 may vary somewhat, affecting the low-frequency response. Correction is accomplished by adjusting R29, labeled L F ADJ, while observing the response to a 40- to 60-cycle square wave. The Tektronix Type 104 and Type 105 Square-Wave Generators provide a suitable signal for this adjustment.

HIGH-FREQUENCY RESPONSE ADJUSTMENT

The wide-band amplifier of the Type 121 is adjusted at the factory for optimum transient response. This results in a gradually decreasing high-frequency response, with appreciable gain well above the specified 3-db-down point of 12 mc. The 3-db point may be extended considerably beyond 12 mc by increased settings of the compensating inductors, at the expense of a sharp cut-off and overshoot on high-speed transient signals, but this adjustment is not normally recommended.

NOTE: The high-frequency adjustments are very stable and under normal conditions will not require attention. If waveform distortion is observed, the signal generator, oscilloscope and other equipment should be eliminated as possible sources before attempting to readjust the Type 121.



If improper high-frequency adjustment is suspected, it should be checked by observing the response to a 1-mc square wave having a rise time of 0.03 microseconds or less. This test signal should have the squarest possible corners and a minimum of overshoot so that the compensation adjustments are not inadvertently used to correct for waveform deficiencies originating in the signal source.

The Tektronix Type 104 and Type 105 Square-Wave Generators provide a suitable signal.

The oscilloscope used in conjunction with the Type 121 for this adjustment should have a bandwidth of 8 mc or greater and a rise time of .05 microseconds or less. There should be a minimum of overshoot or other waveform distortion. The square-wave generator should first be connected directly to the oscilloscope and the waveform observed. Then transfer the square-wave generator to the SIGNAL INPUT of the Type 121 via suitable attenuators, and again observe the waveform. Adjustment is indicated only if appreciable difference is observed.

CAUTION—Be sure the 93-ohm terminated output cable is properly connected.

Since it is possible to achieve nearly the same waveform by over-compensating one stage and under-compensating another, considerable re-adjustment may be required to obtain the best bandwidth consistent with the desired transient response.

The recommended procedure follows:

1. Connect a suitable square-wave generator to the SIGNAL INPUT and oscilloscope to the OUTPUT, as directed above.
2. Set square-wave generator frequency at 1 mc and the oscilloscope sweep at 2 microseconds.
3. Set the DEFLECTION SENSITIVITY controls at .0025 v/cm (full gain) and adjust the square-wave generator output to 7.5 millivolts so that a 3-cm deflection will be obtained.
4. Loosen the locknuts on compensating inductors L1, L2, L3, L4, L6 and L7 carefully to avoid change of the core settings.
5. Slightly increase or decrease the inductance of each, while noting the effect produced on the observed waveform. The series inductors, L2, L4 and L7, will be

found to affect the extreme corner, and the shunt inductors the portion immediately following. Proper adjustment is achieved when the square-wave signal amplified by the Type 121 is a facsimile of the waveform observed with the oscilloscope only.

6. Move the DEFLECTION SENSITIVITY switch, SW1, to .025, increase the input signal to 75 millivolts and adjust C12.

NOTE: If suitable attenuators are not available to reduce the square-wave generator output to the specified levels, the adjustments may be made with the DEFLECTION SENSITIVITY potentiometer in the fully counterclockwise position, thus permitting 10 times the specified signal amplitudes.

If the adjustments have been seriously disturbed, it may be desirable to first adjust the 3rd stage independently. This is accomplished by connecting the square-wave generator to the grid of the attenuator cathode-follower stage via a blocking capacitor. The leads must be short. Ground the SIGNAL INPUT to prevent pickup of extraneous signals, then adjust L6 and L7. Transfer the square-wave generator to the SIGNAL INPUT and adjust L1, L2, L3 and L4.

BANDWIDTH MEASUREMENT

The bandwidth of the Type 121 may be measured with the aid of a sine-wave signal generator equipped with calibrated output level controls, and a 0-1 volt range peak-reading vacuum tube voltmeter.

Connect the V T V M to the Type 121 output via the 93-ohm terminated output cable, and also connect the signal generator to the SIGNAL INPUT by means of a suitably terminated cable. Set the signal generator frequency at 1 mc and the output amplitude so that the V T V M indicates 0.8 volt. While maintaining the same signal amplitude, increase the generator frequency and record the meter readings at convenient points. If the 3-db-down point occurs below 12 mc, re-adjustment of the high-frequency compensating inductors is indicated.

NOTE: The bandwidth is slightly reduced at intermediate settings of the DEFLECTION SENSITIVITY potentiometer.

SERIAL NO. 1321

IMPORTANT

Include the INSTRUMENT TYPE and the above SERIAL NUMBER in any correspondence regarding this instrument. The above serial number must match the instrument serial number if parts are to be ordered from the manual. Your help in this will enable us to answer your questions or fill your order with the least delay possible.



WARRANTY

This instrument is guaranteed to the original user to be free from defects in material and workmanship for a period of one year from date of purchase. Our responsibility under this warranty is limited to the repair or replacement of the instrument, or any part thereof, failure of which is not due to abuse.

For service under this warranty, promptly advise the factory of all details pertinent to the failure. Replacement parts will be shipped, via air transportation upon request, prepaid to any point within the continental United States or Canada. Should it be more convenient to ship the entire instrument, transportation prepaid, to the factory, it will be serviced as required, at no charge and returned via surface transportation.

Replacement parts ordered after termination of warranty will be billed at current net prices and shipped via air prepaid to any point within the continental United States or Canada.

All price revision and design modification privileges reserved.

DEFLECTION SENSITIVITY, VOLTS/CM

OSCILLOSCOPE SENS. = .25 V/CM

2.5 .25 .025 .0025

X100 X10 X1

2 .5 .6 1.5

.4 .7

.3 .8

.2 .9

.1

10 1

VOLTAGE GAIN

SIGNAL INPUT



OUTPUT
TO 93Ω CABLE

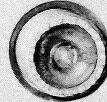

+ 20V TO +100V
10 MA

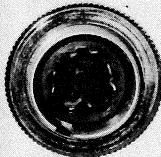

+6.3V
.2 AMP

GND.

ADJUST
+ 20V TO +100V



POWER
ON



TYPE 121 WIDE BAND PRE-AMPLIFIER

SERIAL

TEKTRONIX, INC., PORTLAND, OREGON, U. S. A.

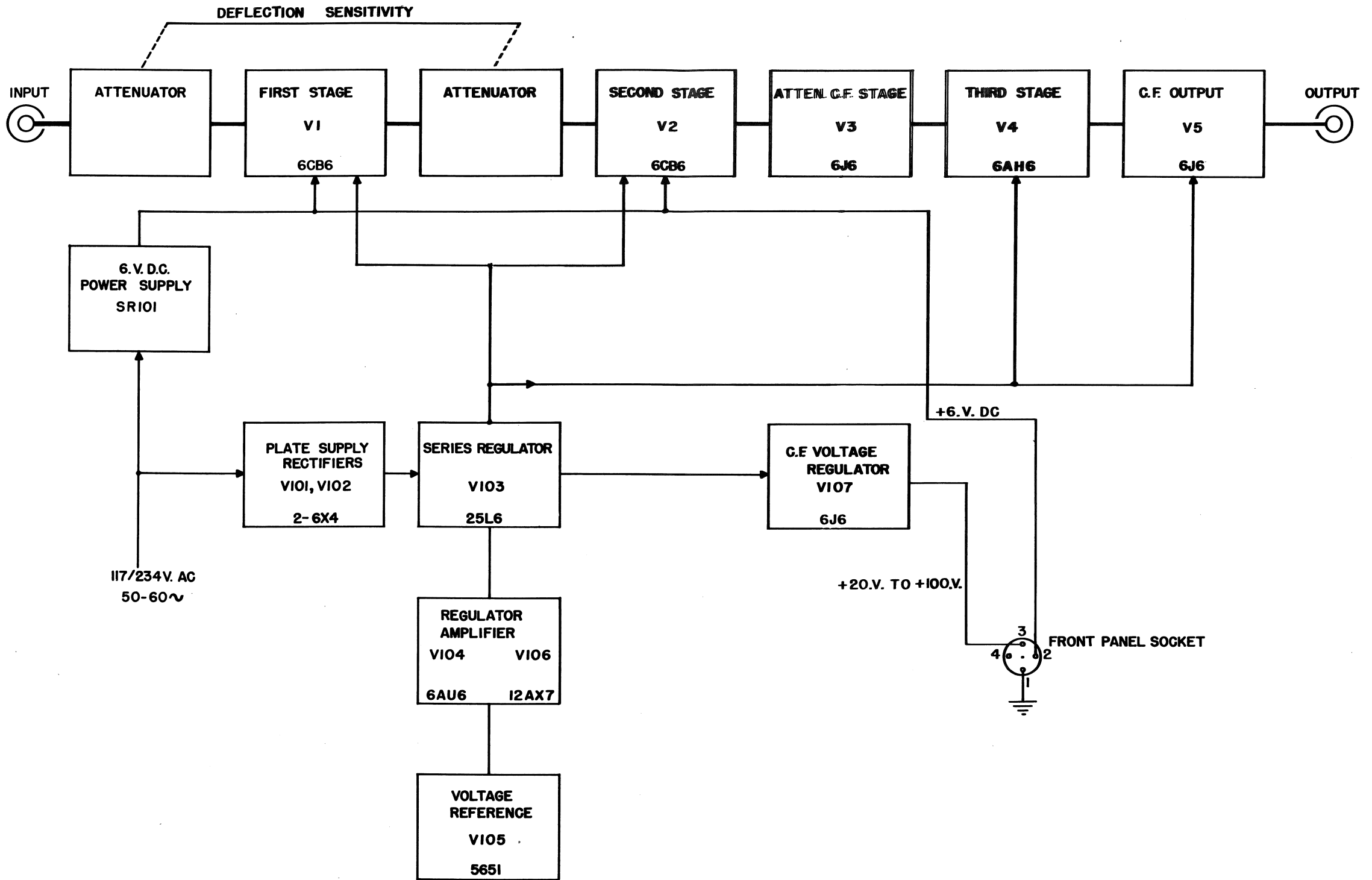

BLOCK DIAGRAM

TYPE 121 WIDEBAND PRE-AMPLIFIER

ABBREVIATIONS

Cer.	ceramic	m	milli or 10 ⁻³
Comp.	composition	Ω	ohm
EMC	electrolytic, metal cased	PMC	paper, metal cased
f	farad	Poly.	polystyrene
GMV	guaranteed minimum value	Prec.	precision
h	henry	PT	paper tubular
k	kilohm or 10 ³ ohms	v	working volts dc
meg	megohm or 10 ⁶ ohms	Var.	variable
μ	micro or 10 ⁻⁶	w	watt
μμ	micromicro or 10 ⁻¹²	WW	wire wound

AMPLIFIER CIRCUITS

Capacitors

C1	5-20 μμf	Cer.	Var.	500 v		
C2	1.5-7 μμf	Cer.	Var.	500 v		
C3	27 μμf	Cer.	Fixed	400 v	20%	
C4	5-20 μμf	Cer.	Var.	500 v		
C5	1.5-7 μμf	Cer.	Var.	500 v		
C6	330 μμf	Mica	Fixed	400 v	20%	
C7	.1 μf	PTM	Fixed	600 v	20%	
C9	.1 μf	PTM	Fixed	400 v	20%	
C10	275 μf	EMC	Fixed	6 v	-20%	+50%
C13	1.5-7 μf	Cer.	Var.	500 v		
C14	12 μμf	Cer.	Fixed	400 v	20%	
C15a	20 μf	EMC	Fixed	450 v	-20%	+50%
C15b	20 μf	EMC	Fixed	450 v	-20%	+50%
C16	275 μf	EMC	Fixed	6 v	-20%	+50%
C18	.1 μf	PTM	Fixed	400 v	20%	
C19	100 μf	EMC	Fixed	25 v	-20%	+50%
C20	6.25 μf	EMC	Fixed	300 v	-20%	+50%
C21	275 μf	EMC	Fixed	6 v	-20%	+50%
C22a	20 μf	EMC	Fixed	450 v	20%	
C22b	20 μf	EMC	Fixed	450 v	-20%	+50%
C23	.047 μf	PTM	Fixed	400 v	20%	
C24	40 μf (2x20)	EMC	Fixed	450 v	-20%	+50%
C25	40 μf (2x20)	EMC	Fixed	450 v	-20%	+50%

Inductors

L1	3.3-7 μh	Var.	CV332
L2	3.3-7 μh	Var.	CV332
L3	3.3-7 μh	Var.	CV332
L4	4.8-9 μh	Var.	CV482
L5	1.0 μh	Fixed	CF102
L6	3.3-7 μh	Var.	CV332
L7	6.5-13 μh	Var.	CV652
L8	7.1 μh	Fixed	CF712

Resistors

R1	900 k	1 w	Fixed	Prec.	1%
R2	111 k	½ w	Fixed	Prec.	1%
R3	990 k	1 w	Fixed	Prec.	1%
R4	10.1 k	½ w	Fixed	Prec.	1%
R5	1 meg	½ w	Fixed	Prec.	1%
R7	820 ohm	½ w	Fixed	Comp.	5%
R8	150 ohm	½ w	Fixed	Comp.	10%
R9	2.7 k	1 w	Fixed	Comp.	10%
R10	900 k	1 w	Fixed	Prec.	1%
R11	111 k	½ w	Fixed	Prec.	1%
R12	1 meg	½ w	Fixed	Comp.	10%
R13	4.7 k	1 w	Fixed	Comp.	10%
R14	1.2 k	½ w	Fixed	Comp.	5%
R15	150 ohm	½ w	Fixed	Comp.	10%
R16	10 ohm	½ w	Fixed	Comp.	10%
R17	1.5 k	2 w	Fixed	Comp.	10%
R18	22 meg	½ w	Fixed	Comp.	10%
R19	1 meg	½ w	Fixed	Comp.	10%
R20	2.2 k	1 w	Fixed	Comp.	10%
R21	500 ohm	2 w	Var.	Comp.	20% DEFLECTION SENSITIVITY
R22	47 ohm	½ w	Fixed	Comp.	10%
R23	10 k	2 w	Fixed	Comp.	10%
R24	1.2 k	½ w	Fixed	Comp.	5%
R25	150 ohm	½ w	Fixed	Comp.	10%
R26	10 ohm	½ w	Fixed	Comp.	10%
R27	22 k	½ w	Fixed	Comp.	10%
R28	220 k	½ w	Fixed	Comp.	10%
R29	1 meg	2 w	Var.	Comp.	20% L. F. ADJ.
R30*	91 ohm	½ w	Fixed	Comp.	0 +5%

*(Part of Output Cable)

Switches

SW1	4 wafer	4 position	Rotary	DEFLECTION SENSITIVITY
-----	---------	------------	--------	------------------------

Vacuum Tubes

V1	6CB6	1st Amplifier
V2	6CB6	2nd Amplifier
V3	6J6	Attenuator cathode follower
V4	6AH6	3rd Amplifier
V5	6J6	Output cathode follower

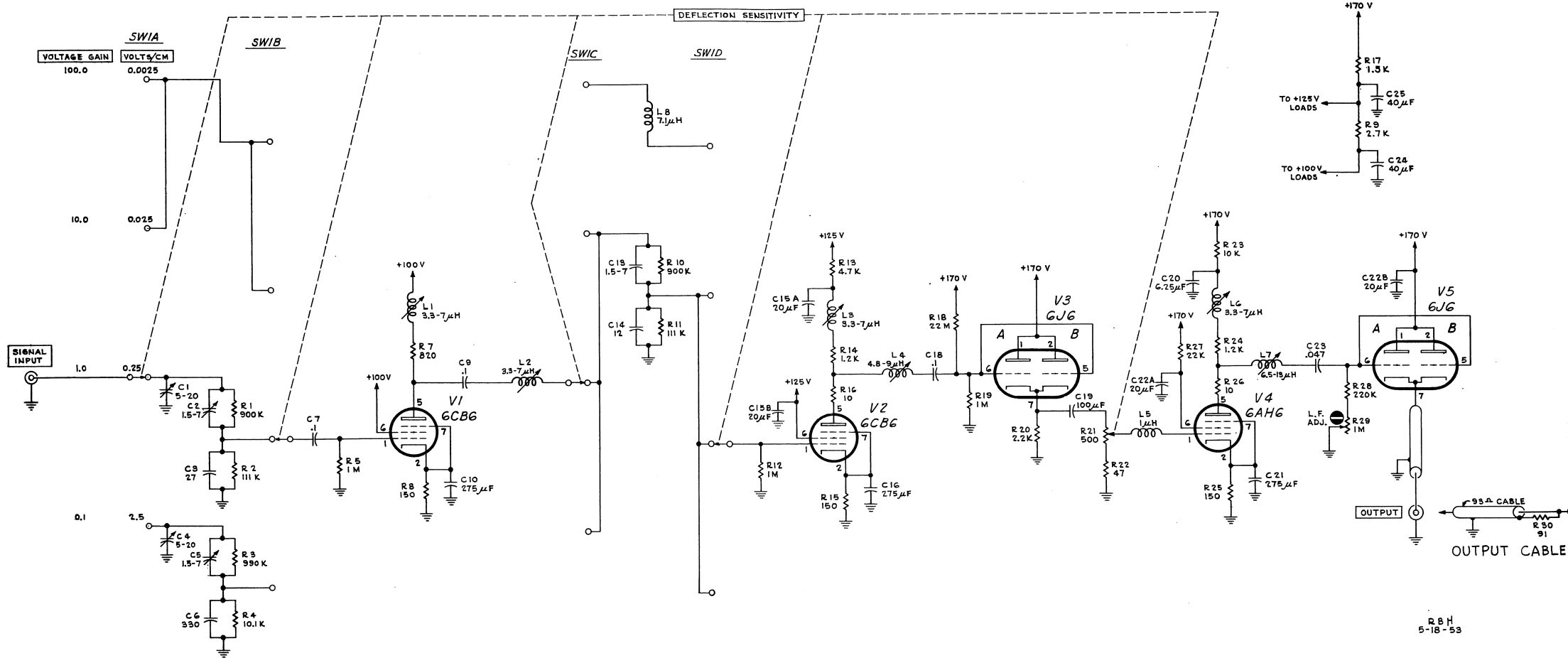

TYPE 121

B

WIDE-BAND PREAMPLIFIER

RBH
5-18-53

PREAMPLIFIER

ABBREVIATIONS

Cer.	ceramic	m	milli or 10 ⁻³
Comp.	composition	Ω	ohm
EMC	electrolytic, metal cased	PMC	paper, metal cased
f	farad	Poly.	polystyrene
GMV	guaranteed minimum value	Prec.	precision
h	henry	PT	paper tubular
k	kilohm or 10 ³ ohms	v	working volts dc
meg	megohm or 10 ⁶ ohms	Var.	variable
μ	micro or 10 ⁻⁶	w	watt
μμ	micromicro or 10 ⁻¹²	WW	wire wound

POWER SUPPLY

Capacitors

C101a	1000 μf (½-2x1000)	EMC	Fixed	15 v	-20%	+50%
C101b	1000 μf (½-2x1000)	EMC	Fixed	15 v	-20%	+50%
C102a	20 μf (½-2x20)	EMC	Fixed	450 v	-20%	+50%
C102b	20 μf (½-2x20)	EMC	Fixed	450 v	-20%	+50%
C103a	20 μf (½-2x20)	EMC	Fixed	450 v	-20%	+50%
C103b	20 μf (½-2x20)	EMC	Fixed	450 v	-20%	+50%
C104	.01 μf	PT	Fixed	400 v		20%
C105	40 μf (2x20)	EMC	Fixed	450 v	-20%	+50%
C106	.01 μf	PT	Fixed	400 v		20%

Inductors

L101	1 h	Fixed	1.4 amp.
L102	10 h	Fixed	80 ma.

Resistors

R101	47 ohm	½ w	Fixed	Comp.	10%
R102	47 ohm	½ w	Fixed	Comp.	10%
R103	2 k	10 w	Fixed	WW	5%
R104	100 ohm	½ w	Fixed	Comp.	10%
R105	470 k	½ w	Fixed	Comp.	10%
R106	10 k	2 w	Fixed	Comp.	10%
R107	4.7 k	2 w	Fixed	Comp.	10%
R108	33 k	1 w	Fixed	Comp.	10%
R109	470 ohm	½ w	Fixed	Comp.	10%
R110	470 ohm	½ w	Fixed	Comp.	10%
R111	470 k	½ w	Fixed	Comp.	10%
R112	330 k	½ w	Fixed	Comp.	10%
R113	470 k	½ w	Fixed	Comp.	10%
R114	68 k	½ w	Fixed	Comp.	10%
R115	20 k	1 w	Var.	Comp.	20% ADJ. TO +170V
R116	68 k	½ w	Fixed	Comp.	10%
R117	1 meg	2 w	Var.	Comp.	20% ADJ. TO +20V TO +100V
R118	470 k	½ w	Fixed	Comp.	10%
R119	27 ohm	½ w	Fixed	Comp.	10%
R120	27 ohm	½ w	Fixed	Comp.	10%
R121	100 ohm	½ w	Fixed	Comp.	10%
R122	220 k	½ w	Fixed	Comp.	10%

Switches

SW101 Single Pole Single Throw Toggle POWER

Transformers

T101 Plate and Heater Supply
Primary: 117/234 volt 50/60 cycle
Secondaries: 235-0-235 V, 80 ma.
 7.2-0-7.2 V, 1.4 amp.
 27 V, .3 amp.
 6.7 V, 1.2 amp.
 6.7 V, 1.2 amp.

Vacuum Tube Complement

V101 6X4 High-Voltage Rectifiers
V102 6X4 High-Voltage Rectifiers
V103 25L6 Series Regulator
V104 6AU6 Regulator Amplifier

V105 5651 Voltage Reference
V106 12AX7 Regulator Comparator
V107 6J6 Front-Panel Power-Supply-Socket Cathode Follower

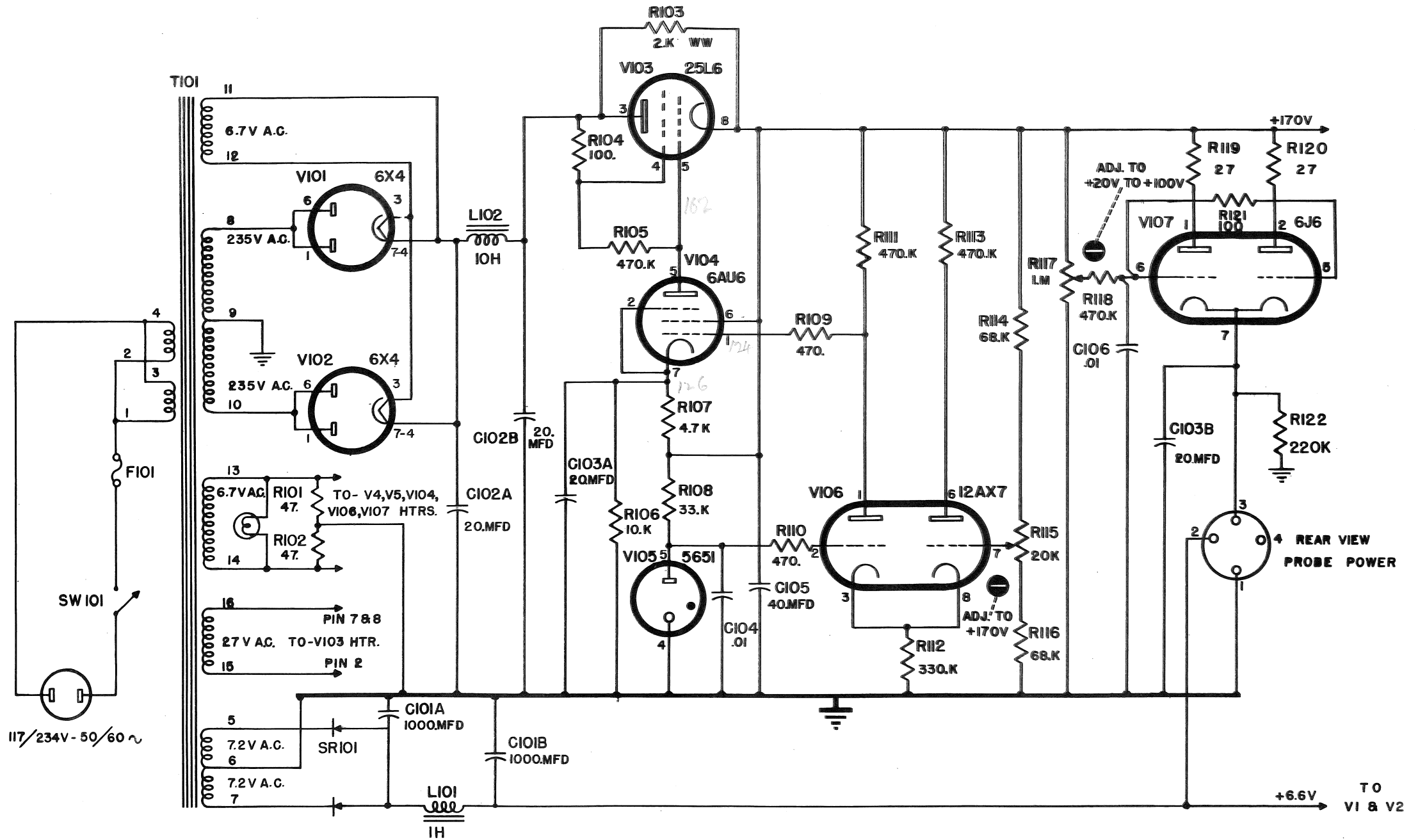

TYPE 121

2-6-53
POWER SUPPLY

POWER SUPPLY

ACCESSORIES

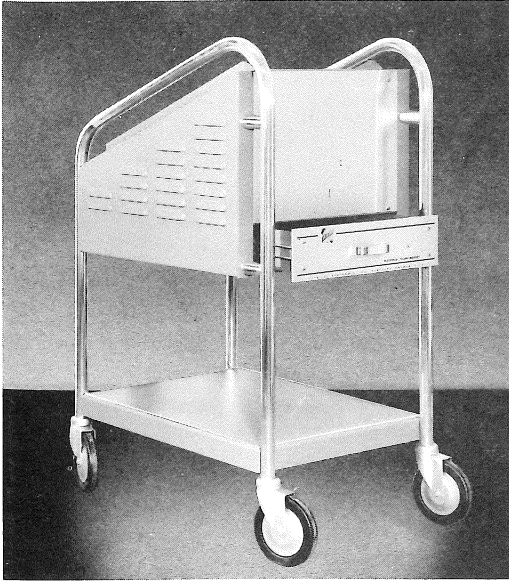

The **TEKTRONIX Type 500 Scope-Mobile** has been especially designed to accommodate the Tektronix Cathode Ray Oscilloscopes. It provides a sturdy yet mobile and therefore highly useful support for the Oscilloscope. Convenient and easy observation of the CRT face is achieved by a 20° tilt back.

A blank panel, 11"x15", fronting a mounting space of approximately 1½ cubic feet allows for auxiliary built-in equipment as an aid in meeting specialized requirements. This space is fully ventilated by means of louvres. A power input connector and three convenience outlets appear at the back.

A drawer is provided for the handy storage of cords, probes, instruction books, small tools, etc. For quietness and ease of operation the drawer, 15"x15"x3" in size, is felt lined and operates in roller bearing support runners. An open shelf, 17"x24" in size and topped with battleship linoleum, is located at the bottom of the unit.

Total "dry" weight of the Scope-Mobile is approximately 42 pounds and clearance dimensions are 18½" wide, 39" high and 30" deep. **Price — \$97.50**

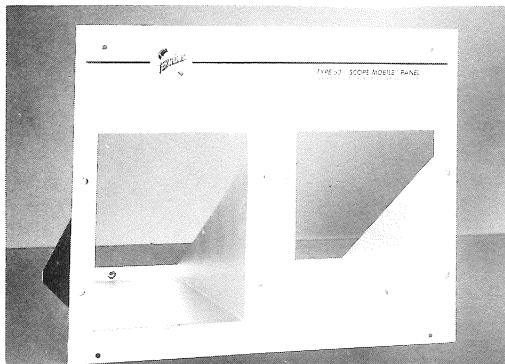

Type 53 Scope-Mobile Panel — replaces standard blank panel in the Scope-Mobile. It has two supporting cradles designed to accommodate the Type 53 Plug-In Preamplifiers used with Type 530 Series Oscilloscopes. 10.50

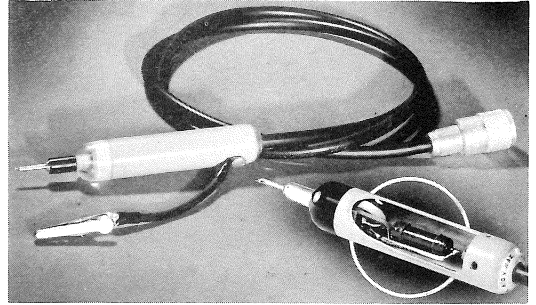

P510A Attenuator Probe provides an attenuation of ten times when used with Tektronix oscilloscopes and amplifiers. The P510A is small and streamlined, and presents an input impedance of 10 megohms paralleled by 14 μmf. The probe is completely insulated — made of high-impact-strength fiberglass-reinforced alkyd — and has an internal brass shield. Two interchangeable tips are furnished — a Klipzon tip and an alligator clip assembly. A ground clip is attached to the probe body. The probe has a 42" coaxial cable with uhf connector, and is rated at 600v peak-to-peak. \$8.50
 Replacement Klipzon tips65
 Replacement alligator tips40

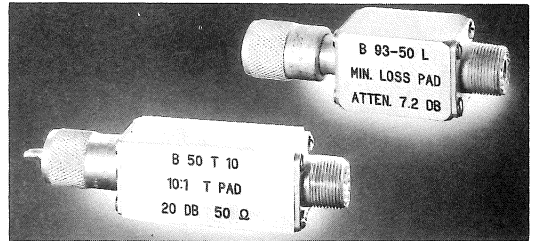

B52-R 52-ohm terminating resistor, 1.5w. \$ 8.50
B52-L5 52-ohm 'L' pad, 5 to 1 voltage ratio, 1.5w 8.50
B52-L10 52-ohm 'L' pad, 10 to 1 voltage ratio, 1.5w 8.50
B52-75L Minimum-loss pad, 52 ohms to 75 ohms. 11.50
B52-170L Minimum-loss pad, 52 ohms to 170 ohms 11.50
B52-T10 52-ohm 'T' pad, 10 to 1 voltage ratio, 1.5w 11.50
B75-R 75-ohm terminating resistor, 1.5 w. 8.50
B75-L5 75-ohm 'L' pad, 5 to 1 voltage ratio, 1.5w 8.50
B75-L10 75-ohm 'L' pad, 10 to 1 voltage ratio, 1.5w 8.50
B75-T10 75-ohm 'T' pad, 10 to 1 voltage ratio, 1.5w 11.50
B93-R 93-ohm terminating resistor, 1.5w. 8.50
B93-L5 93-ohm 'L' pad, 5 to 1 voltage ratio, 1.5w 8.50
B93-L10 93-ohm 'L' pad, 10 to 1 voltage ratio, 1.5w 8.50
B93-52L Minimum-loss pad, 93 ohms to 52 ohms, 1.5w 11.50
B93-T10 93-ohm 'T' pad, 10 to 1 voltage ratio, 1.5w 11.50
B170-R 170-ohm terminating resistor, 1.5w. 8.50
B170-V 170-ohm attenuator, 1 to 64 db in 1 db steps, 0.25w 45.00

ACCESSORIES

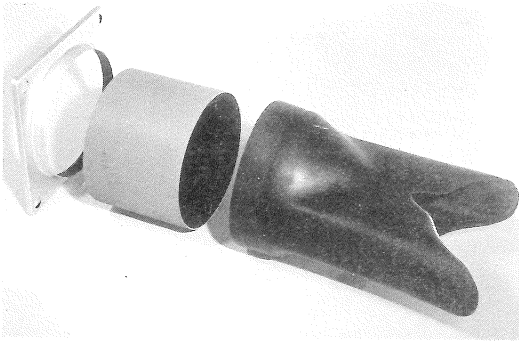

H510 Viewing Hood, for Tektronix 5" Oscilloscopes. Two-piece construction, rubber and aluminum, permits use of aluminum tube as deep light shield for less critical applications. Replacement graticule cover included. 4.50

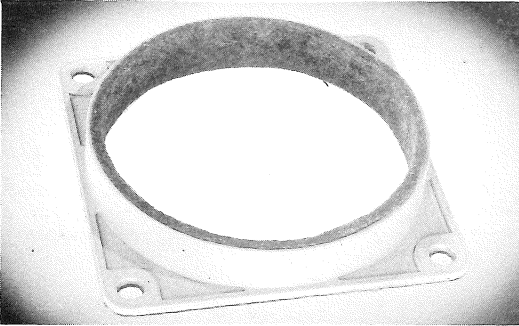

BE510 Bezel, for mounting camera on Tektronix 5" Oscilloscopes. Dimensions — $5\frac{7}{8}$ " square; ring $\frac{7}{8}$ " deep, diameter $5\frac{5}{8}$ " outside, $5\frac{1}{8}$ " inside. Die-cast construction, gray wrinkle finish, felt lined. 4.50

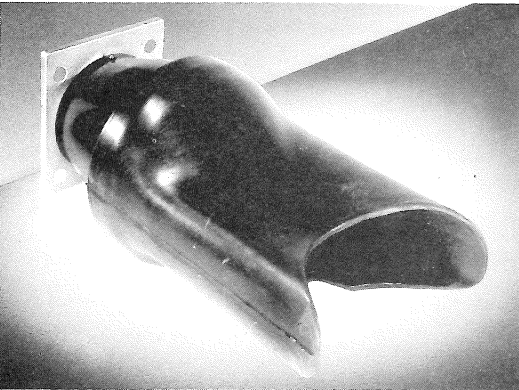

H310 Viewing Hood, for Tektronix 3" Oscilloscopes. Includes rubber eye-piece, spun-aluminum light shield, and replacement graticule cover. 4.50

CATHODE-RAY TUBE LIGHT FILTERS

F310-3 (3" amber)	\$.50
F310-5 (3" green)50
F310-6 (3" blue)50
F510-3 (5" amber)90
F510-5 (5" green)90
F510-6 (5" blue)90

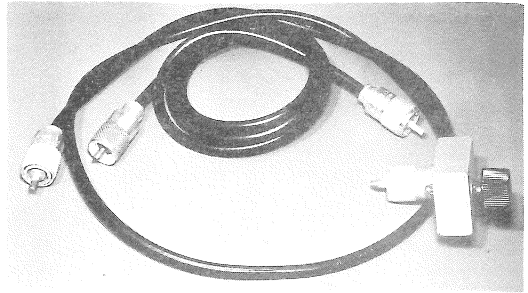

COAXIAL CABLES

P52	Coaxial Cable, 52 ohms nominal impedance, 42" long.	\$ 4.00
P75	Coaxial Cable, 75 ohms nominal impedance, 42" long.	4.00
P93	Coaxial Cable, 93 ohms nominal impedance, 42" long.	4.00
P93A	Coaxial output cable, 93 ohms, terminated at end with variable attenuator, 42" long.	13.50
P93B	Coaxial output cable, 93 ohms, terminated at end with $\frac{1}{2}$ -watt 93-ohm resistor, 42" long.	5.00
P170	Coaxial cable, 170 ohms nominal impedance, 42" long.	9.50

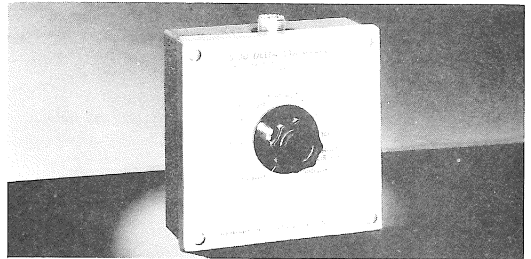

S30 Delta Standards, for calibration of the Type 130 L.C. Meter. The unit provides accurately adjusted steps of capacitance and inductance, selected by a rotary selector switch. Values of the capacitance steps correspond to the full-scale adjustments required on the five scales of the Type 130. Two resistors of identical manufacture and similar capacitance, values of 1 megohm and 0.1 megohm, are provided for the resistance compensation adjustment. A 300- μ h standard permits proper adjustments of the inductance ranges. 22.00

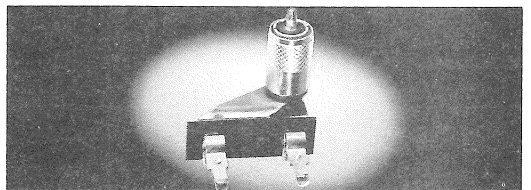

F30 Production Test Fixture, for use with the Type 130 L.C. Meter. Speeds sorting and testing of capacitors and inductors. 3.00

MISCELLANEOUS

A100	Adapter, clip lead.	\$ 2.50
A510	Adapter, binding post.	1.88
FA160	Frame, mounting, for Type 122 and Type 160 series units.	5.00

Tektronix, Inc.

AN OREGON CORPORATION

Main Office and Factory—Sunset Highway and Barnes Road
Mailing Address—P. O. Box 831, Portland 7, Oregon
Phone—CYpress 2-2611 Cable—TEKTRONIX

TEKTRONIX FIELD ENGINEERING OFFICES

BALTIMORE	Tektronix, Inc., 8118 Harford Road, Baltimore 14, Maryland	Boulevard 2600 Washington Area Phone	ENterprise 1-6023
BOSTON	Tektronix, Inc., 18 Austin St., Newtonville 60, Massachusetts	LAsell 7-2212	
CLEVELAND	Tektronix, Inc., 3353 Edgcliff Terrace, Cleveland 11, Ohio	Clearwater 2-2121	
	Dayton Area: ENterprise 7121	Detroit Area: ENterprise 7121	Pittsburgh Area: ZENith 0212
NEW YORK	Tektronix, Inc., 49 Pondfield Road, Bronxville 8, New York	DEerfield 7-3771	
PHILADELPHIA	Tektronix, Inc., 7709 Ogontz Ave., Philadelphia 38, Pennsylvania	WAverly 4-5678	
SYRACUSE	Tektronix, Inc., 313 Nottingham Road, Syracuse 10, New York	Phone: 72-3339	

TEKTRONIX ENGINEERING REPRESENTATIVES

ALBUQUERQUE	Neely Enterprises, 107 Washington St. S. E., Albuquerque, New Mexico	Phone: 5-5586	
ATLANTA	Bivens & Caldwell, 267 East Paces Ferry Road, N. E., Atlanta, Georgia	CHerokee 7522	
CHICAGO	Everett Associates, 6744 N. California Ave., Chicago 45, Illinois	AMBassador 2-3702	
DALLAS	M. F. Klicpera Company, P. O. Box 4117, Sta. A, Dallas 8, Texas	FEderal 0992	
DENVER	Ronald G. Bowen Company, 446 Broadway, Denver 3, Colorado	SHerman 4-2501	
FORT MYERS	Arthur Lynch & Associates, P. O. Box 466, Fort Myers, Florida	Fort Myers 5-6762	
HIGH POINT	Bivens & Caldwell, Security Bank Bldg., High Point, North Carolina	Phone: 3672	
HOUSTON	M. F. Klicpera Company, P. O. Box 3113, Houston 1, Texas	JAckson 2-8459	
INDIANAPOLIS	Everett Associates, P. O. Box 6232, Indianapolis 24, Indiana	BElmont 4893	
KANSAS CITY	Everett Associates, 1629 East 31st St., Kansas City 3, Missouri	ARmour 9539	
LOS ANGELES	Neely Enterprises, 7422 Melrose Ave., Los Angeles 46, Calif.	WEbster 3-9201	
PHOENIX	Neely Enterprises, 1931 West Vermont Ave., Phoenix, Arizona	ALpine 2-5290	
PORTLAND	Hawthorne Electronics, 700 S. E. Hawthorne Blvd., Portland 14, Oregon	FLmore 9375	
SACRAMENTO	Neely Enterprises, 1317 15th St., Sacramento 14, Calif.	GIlbert 2-8901	
SAN DIEGO	Neely Enterprises, 1029 Rosecrans St., San Diego 6, Calif.	ACAdeemy 3-8106	
SAN FRANCISCO	Neely Enterprises, 2830 Geary Blvd., San Francisco 18, Calif.	WAlnut 1-2361	

TEKTRONIX OVERSEAS DISTRIBUTORS

BRUSSELS	Regulation-Mesure, 56, rue des Bollandistes, Brussels, Belgium	Phone: 34.42.96	
COPENHAGEN	Tage Olsen A/S, 4, Vestre Boulevard, Copenhagen, Denmark	Phone: Palae 1369, Palae 1343	
HELSINKI	Into O/Y, 11 Meritullinkatu, Helsinki, Finland	Phone: 21 425, 31 025	
ISRAEL	Landseas Products Corp., 39 Broadway, New York 6, New York	WHitehall 3-6026	
JOHANNESBURG	Protea Holdings, Ltd., 7 Newton St., Wemmer, Johannesburg, South Africa	Phone: 33-2211	
LONDON	Livingston Laboratories Limited, Retcar Street, London N.19, England	Phone: Archway 6251	
OSLO	Eugen Nilsson, Møllergaten 8, Oslo, Norway	Phone: 33 14 28—33 27 62	
PARIS	Relations Techniques Intercontinentales, 10, Rue Pergalese, Paris 16 ^{eme} , France	Phone: PAS. 08-36	
RIO DE JANEIRO	Empresa Comercial Importadora Limitada, Rua Araujo Porto Alegre, 70-8, ^o Rio De Janeiro, Brazil	Phone: 42-9460	
ROME	CESA-Elettronica, viale Liegi N. 62, Rome, Italy	Phone: 846.592—865.722	
STOCKHOLM	Erik Ferner, Björnsonsgatan 197, Bromma, Stockholm, Sweden	Phone: 377700	
TOKYO	Midoriya Electric Co., Ltd., 3,4-Chome, Ginzaishi, Chuo-Ku, Tokyo, Japan	Phone: Kyobashi (56) 0486	
VOORBURG	I. R. C. A., Paradyssstraat 92, Voorburg, Holland	Phone: 0 1700—722449	
ZURICH	Omni Ray AG., Dufourstrasse 56, Zurich 8, Switzerland	Phone: (051) 34-44-30	

Other OVERSEAS areas please write or cable directly to the
Export Department, Portland, Oregon, U.S.A.

Printed in U.S.A.

GENERAL INFORMATION

Terms and Shipment

Our terms are 1% ten days, net thirty days on domestic orders; net thirty days on export orders. Shipping delay may be prevented by establishing credit at time of placing order. When desirable, C.O.D. shipments can be arranged. All prices are f.o.b. Portland (Beaverton), Oregon.

For information relative to discounts on quantity purchases, please contact your nearest Tektronix field office, representative, or distributor.

Although all quotations are for shipment f.o.b. Portland (Beaverton), Oregon, upon request transportation costs can be prepaid and the amount added to the invoice.

Normally, shipments are made by Railway Express or Motor Freight. If shipment by air is desired, please specify Air EXPRESS or Air FREIGHT. Experience has eliminated rail freight as a satisfactory method of surface transportation for electronic instruments.

Export Orders

All orders and inquiries from countries other than the United States should be addressed directly to: Tektronix, Inc., Export Department, P. O. Box 831, Portland 7, Oregon. Cable address: TEKTRONIX.

Delivery

Acceptance of purchase orders is indicated by our acknowledgment, and estimated shipment time is given from date of acknowledged acceptance. Every effort is made to meet the estimated shipment date, but there is the possibility that circumstances beyond our control might make it impossible to meet the quoted schedules.

Field Maintenance

Tektronix Field Maintenance is provided on a non-profit basis, as a service to our customers. Work is expedited whether or not the instrument is in warranty.

Requests for repairs or replacement parts should include type number and serial number and should be directed to our representative or branch office in your area. In an emergency, please wire or phone Field Engineering, Tektronix, Inc., Portland, Oregon, in addition to notifying the local representative. This procedure will assure you the fastest possible service.

If an instrument must be returned to the factory for repairs, notify Field Engineering directly or through the local representative, **indicating type number and serial number**, and you will be notified at once as to procedure to be followed. PLEASE DO NOT RETURN AN INSTRUMENT BEFORE RECEIVING DIRECTIONS. Instruments and parts returned from countries other than the United States *must be accompanied by an invoice* to clear through customs.

It is standard practice for Tektronix to incorporate improvements into production instruments as they are developed in our laboratories. Owners of existing instruments are notified of modifications, and modification kits are made available, when practicable, to those who wish to modernize their own instruments.

For customers who have large quantities of Tektronix instruments and wish to equip their maintenance departments with factory-tested components, integrated kits of parts are available. Kits are designed to cover expected needs of a group of ten instruments of the same type.

Warranty

All Tektronix instruments are fully guaranteed against defective materials and workmanship for one year. Should replacement parts be required, whether at no charge under warranty or at established net prices, they will be shipped from the factory, via air transportation on request, prepaid to any point within continental North America.

Tektronix transformers manufactured in our own plant carry an indefinite warranty. In the event of failure please be sure to contact the nearest Tektronix Field Engineer, Representative or Headquarters.

CALIBRATION RECORD

Tektronix Type 121 — Serial No. 1321

1. Connect output cable.
2. Adjust 170v. regulation.
3. Adjust probe voltage.
4. Check 6 volt D.C. supply and ripple.
5. 72 Watts. Power consumption.
6. Adjust Attenuator.
7. Check Step Attenuator and Vernier Attenuator.
8. 40 DB. Gain.
9. 4.0 Millivolts. Hum level.
10. 2.0 Millivolts. Noise level.
11. Adjust L.F. compensation.
12. Adjust H.F. compensation.
13. 1.1 DB down at 12 MC (.025 position).
14. 2.0 DB down at 12 MC (.0025 position).

By A. Davenport
Test-Calibration Dept.

Date OCT 18, 1954