



Digital  
Multimeters and  
Thermometers



Scientific  
Instruments



System  
Components

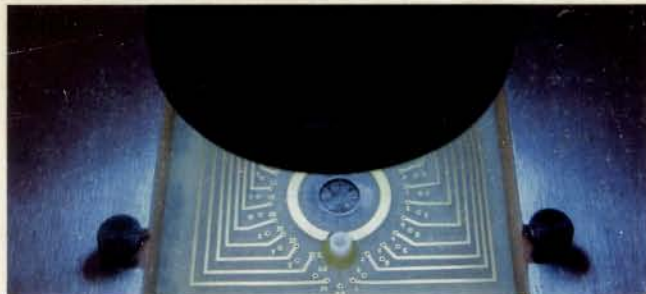

Parametric  
Test Systems



Radiation  
Measurements

For over three decades, Keithley ultrasensitive instruments have made a significant contribution to the electronic research that has led to our present level of technological development. In the process, we have earned a reputation for reliability, and have consistently been honored for innovation in ultra-sensitive instrumentation design. In the sixteen years that *Industrial Research & Development* magazine has annually cited the 100 best new product designs, Keithley products have won eight such "IR-100" awards.

### User-Oriented Design

But the real Keithley differential is that we always combine this sensitivity, reliability and innovation in products with practicality to *address the user's needs*. This application orientation means that you can get a given task done without buying unneeded capacity, without paying for unwanted features, without locking dollars into restrictive, dedicated equipment.

### System Components

This precision with practicality is readily apparent in our growing selection of modular System Components. This family of programmable meters, sources and scanners gives you maximum reconfigurability plus the freedom to use the various components on a stand-alone bench basis. The compatible designs of these products eliminate interfacing problems commonly found in non-modular instrumentation systems.

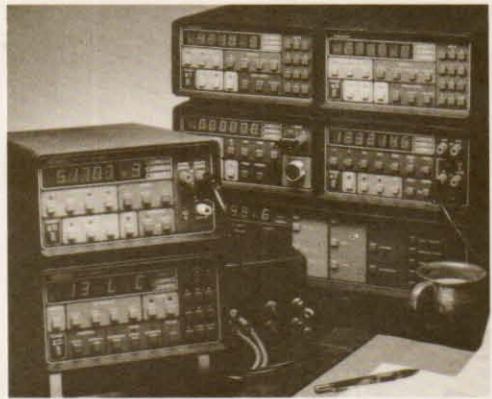

### Temperature Measurement

We have expanded our new product development efforts and extended our handheld meter line to include temperature measurement. We have the right thermometer for many applications, from the stringent requirements of the research scientist to the daily needs of the office copier service technician.

### A Full Line

From digital thermometers, to handheld DMMs, to programmable bench instruments, to parametric test systems, to radiation measurement instrumentation, you can count on Keithley to provide the performance you expect from a world leader in high technology, electronic measurement instrumentation.

# KEITHLEY

# Table of Contents

## SYSTEM COMPONENTS

- 2 Selector Guide
- 3 Product Overview
- 5 705/Scanner
- 7 Scanner Cards
- 9 703/Scanner
- 10 8001, 8002, 8003/Test Boxes
- 11 85/Controller and Peripherals

---

## DIGITAL MULTIMETERS

- 12 Selector Guide
- 14 Technical Data
- 17 130, 131/Handheld DMMs
- 18 128/Handheld Beeper DMM
- 19 135A/4½-Digit Handheld DMM
- 20 132C, 132F/Handheld DMMs
- 22 169/Portable/Bench DMM
- 24 179A/4½-Digit Portable/Bench DMM
- 26 177/μV Bench DMM
- 28 191/5½-Digit Bench DMM
- 30 192/Programmable DMM
- 32 195/System DMM
- 34 195T/System DMM
- 35 Accessory Selector Guide

---

## THERMOMETERS

- 36 Selector Guide
- 37 Technical Data
- 40 871, 872/Thermocouple Thermometers & Probes
- 42 865, 866/Thermistor Thermometers & Probes
- 44 868, 869/RTD Thermometers & Probes

---

## ELECTROMETERS, PICOAMMETERS

- 46 Selector Guide
- 47 Technical Data
- 50 619/Electrometer/Multimeter
- 52 642/FET Electrometer
- 54 614/Digital Electrometer
- 56 616/Autoranging Digital Electrometer
- 58 602/Analog Electrometer
- 59 610C/Analog Electrometer
- 60 427/High Speed Current Amplifier
- 61 480/Digital Picoammeter
- 62 18000-20/Programmable Current Amplifier
- 63 26000 Series/Logarithmic Picoammeters
- 64 301, 302/Electrometer Operational Amplifiers
- 65 Accessory Selector Guide

---

## NANOVOLTMETERS

- 66 Selector Guide
- 67 Technical Data
- 69 148/Nanovoltmeter
- 70 181/Digital Nanovoltmeter
- 72 155/Microvoltmeter/Null Detector
- 73 262/Voltage Divider
- 74 Accessory Selector Guide

---

## SOURCES

- 75 Selector Guide
- 76 220/Programmable Current Source
- 76 230/Programmable Voltage Source
- 78 225/Constant Current Source
- 79 227/Constant Current Source
- 80 261/Picoampere Source
- 81 247/High Voltage Power Supply

---

## 82 ACCESSORIES

- 92 SERVICE & ORDERING INFORMATION
- 92 SYSTEMS DIVISION
- 94 RADIATION MEASUREMENTS DIVISION
- 96 INDEX/Product Description
- 97 INDEX/Model Number
- 98 Sales Representatives/Europe
- 99 Sales Representatives/International
- 100 Sales Representatives/Distributors
- Inside Back Cover Sales Representatives/U.S.

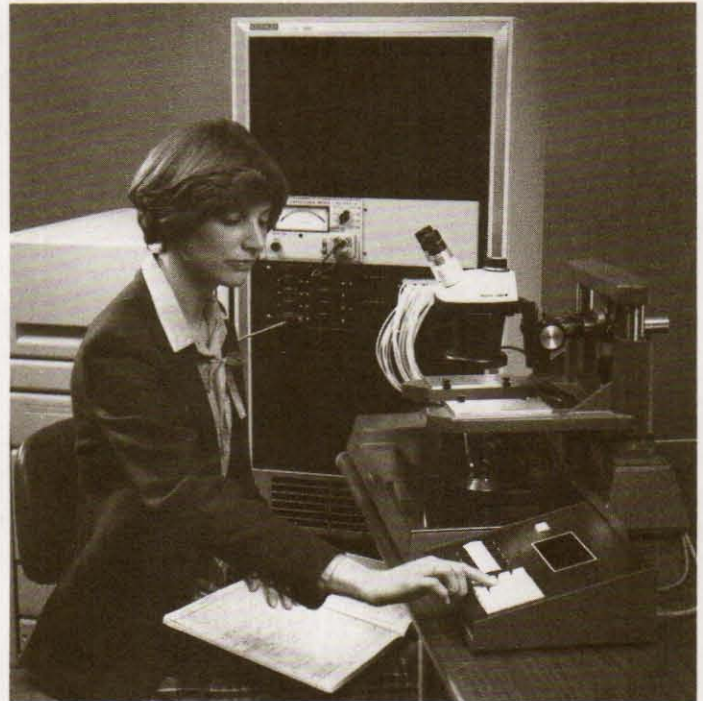

# Selector Guide/System Components

## SYSTEM METERS

MODEL	DESCRIPTION	IEEE	DC VOLTS	AC VOLTS	DC AMPS	AC AMPS	OHMS	COMMENT
181	6½-Digit Nanovoltmeter	Std.	10nV resolution	N/A	N/A	N/A	N/A	Digital filter
192	6½-Digit Programmable DMM	1923 opt.	100nV resolution	1910 opt. avg. 1920 opt. TRMS AC+DC	N/A	N/A	Automatic 2/4 wire	Zero, stored programs
195	5½-Digit Programmable DMM	Std.	100nV resolution	1950 opt. TRMS	1950 opt. 6 ranges	1950 opt. 5 ranges	Automatic 2/4 wire	Digital calibration
619	5½-Digit Electrometer/Multimeter	6193 opt.	10µV resolution	N/A	100fA to 2A	N/A	100mΩ to 2TΩ	Opt. dual channel, A/B, A-B

## SWITCHING

MODEL	DESCRIPTION	IEEE	GUARD	POLE CONFIGURATION	MAXIMUM SWITCHING			CONTACT POTENTIAL	OFFSET CURRENT	COMMENT
					VOLTS	AMPS	V•A			
705	System Scanner	Std.								20 channel main-frame; expandable to 100 channels
7052	5×4 Matrix Card	N/A	Switched	3 Form A	200V	200mA	10	< 50µV	N/A	20 cross points
7053	High Current Scanner Card	N/A	Common	2 Form A	300V	5A	100	< 1mV	N/A	5A switching
7054	High Voltage Scanner Card	N/A	Common	1 Form A	1000V	10mA	10	N/A	N/A	1000V switching
7056	General Purpose Scanner Card	N/A	Common	2 Form A	150V	250mA	10	< 100µV	N/A	Quick disconnect
7057A*	Thermocouple Scanner Card	N/A	Common	2 Form A	42V	100mA	2	< 1µV	N/A	Reference in isothermal block
7058	Low Current Scanner Card	N/A	Common	1 Form C	28V	100mA		N/A	< 1pA	< 1pA leakage
7059	Low Voltage Scanner Card	N/A	Common	2 Form A	200V	100mA	2	< 1µV	N/A	< 1µV, 200nV typ.

## SOURCES

MODEL	DESCRIPTION	IEEE	OUTPUT	COMPLIANCE	OUTPUT IMPEDANCE	DWELL TIME	COMMENT
220	Programmable Current Source	Std.	500fA to 100mA	1V to 100V in 1V increments	> 10 <sup>14</sup> Ω	3ms to 1000s	Guard, 100-point memory buffer, digital I/O, trigger
230	Programmable Voltage Source	Std.	50µV to 100V	2mA, 20mA, 100mA	< 1mΩ	3ms to 1000s	100-point memory buffer, digital I/O, trigger, remote sense

\*7057A replaces 7057 effective 4/83.

# System Components/Overview

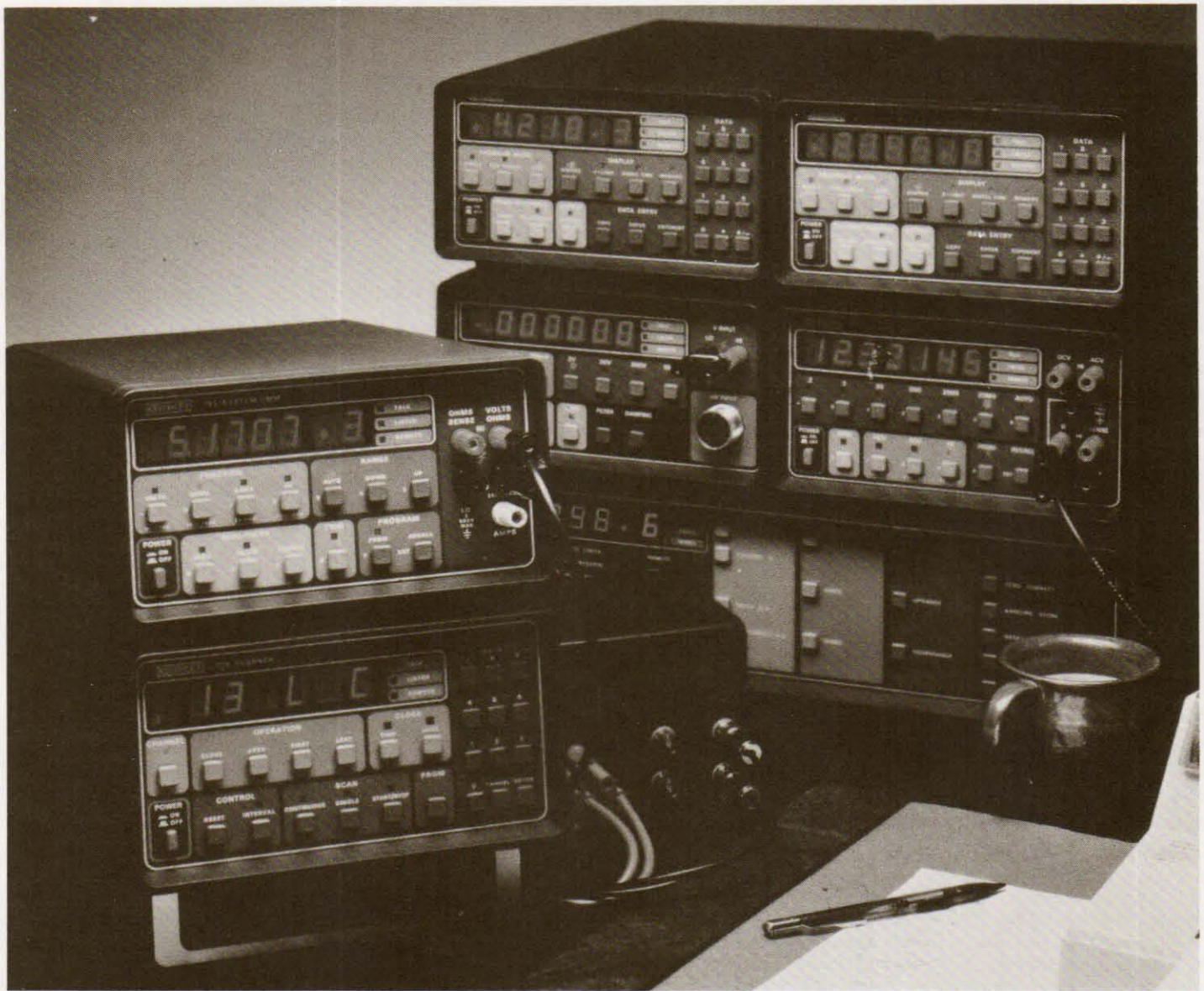

Today's workplace is becoming more competitive. Technological advances and economic pressures have changed the basic character of tests and measurements. The question today revolves around value in terms of measurement efficiency and productivity. Engineers not only expect but insist on solutions to their needs for data, speed, accuracy and resolution, with friendly features that provide flexibility and stimulate ingenuity.

Trends point to increased use of automation spurred by the boom of low-cost controllers. Instrument designers are not standing idle, but are making full use of dedicated microprocessor hardware to simplify operation and to provide flexibility and user-friendly features. To a world where value is so very important, Keithley offers our System Components Line. Designed with your needs in mind, these instruments bring unparalleled performance to your bench or system.

Built-in intelligence makes these products powerful stand-alone units. Standard features such as datalogging memories and program-

mable intervals and triggers can be used in a variety of ways for completely hands-off testing, without a controller. Initiate the test and then use your valuable time for more pressing matters. Accuracy and resolution are satisfied by a selection of capabilities from 3½ to 6½ digits.

Keithley's commitment is to meet your needs, and that includes your future needs. For this reason, we have chosen a modular approach to our instrumentation. Start now with basic bench capability; expand as your applications grow or change, and include a Model 85 controller for full automation at any time. These are your system building blocks, with flexibility to reconfigure or add on as needs change, unlike dedicated instruments where the test problem must be reconfigured to suit the instrument.

Applications and service support are fitted to the needs of our customers. Assistance is only a phone call away. Whether it be questions on measurements, interfacing or the need for service, we enjoy being able to help you work through the problem.

# 705/Scanner

## Small Systems

- IEEE-488 built-in
- Scanning flexibility
- 3 scan modes
- Matrixing
- Quick disconnect
- Expandable to 100 channels



Keithley scanners offer a cost-effective solution for multiple channel requirements. With a low-cost Keithley scanner, a single measuring instrument can monitor signals from several transducers. In an automatic test system, a control signal from a voltage or current source can be sent to multiple points on a device under test.

The Model 705 will scan up to 20 channels and can be interconnected with other units (up to five) for additional channels. The master mainframe can be manually operated or remotely controlled with the IEEE-488 bus.

A variety of plug-in scanner cards is available. Model 7056 offers 10 channels for voltage, current, resistance or matrix operation. For temperature measurements, Model 7057A has a built-in temperature reference. The 10-channel Model 7058 features true current scanning for measurements as low as 0.1pA. Voltage signals as low as 1μV can be scanned with Model 7059. Scanner cards can be mixed in the Model 705 mainframe when multiple signal types must be monitored.

### Scanning

Keithley scanners provide an economical solution for monitoring data from several signal sources with a single measuring instrument. Voltages, currents, resistances and transducer outputs can be scanned in any order. Multiple scanner mainframes can be interconnected to provide up to 200 single-pole (7056 only), 100 two-pole or 50 four-pole channels.

### Controlling

Voltage and current source outputs can be easily distributed to several locations through the use of a Keithley scanner. In many situations,

costly multiple sources can be replaced by a single source and scanner. Scanner relays can be randomly accessed to activate and control external devices.

### Matrixing

Systems with several points to be sourced and/or measured with one test setup require matrixing. The 705 scanner can easily be controlled to activate any combination of multiple channels, thus making it ideal for matrixing. The Model 7052 is a 5×4, 20 crosspoint matrix card with switched guard specifically designed to meet this need.

### 1-pole switching

A 705 mainframe in the single-pole mode and two 7056 general purpose cards can scan 40 thermistors. The single-pole mode is available only with the 7056 card. A separate 1-pole output is provided on the 7056 card to achieve necessary isolation in the 1-pole mode.

### 2-pole switching

Isolated voltages such as those found in various points of a circuit or IC component can be scanned in the 2-pole mode. Incorporating a 705 mainframe in a 2-pole mode with two 7059 low voltage cards will provide 20-channel capability with microvolt sensitivity.

### 4-pole switching

Contact resistances for switches, connectors and/or relays can be measured on several devices. The 705 mainframe in the 4-pole mode with a 7056 general purpose card for the source leads and a 7059 low voltage card for the sense leads provides 10-channel capacity for sensitivity to nanohms.

**705 Specifications**

**CAPACITY:** Two plug-in cards per mainframe.

**EXPANSION CAPACITY:** Daisy chain allows up to 4 SLAVE units with 1 MASTER unit.

**SWITCHING RATE:** 100 channels/second (10ms), programmable to 1 channel/16 minutes (999.999s).

**RELAY DRIVE:** 350mA minimum.

**INTERNAL CLOCK:** Displays hours/minutes/seconds or date/month; less than 1 minute/month error (typical).

**BATTERY BACKUP:** Rechargeable 3.6V nickel-cadmium. 1 month retention of data (typical) with unit turned off.

**IEEE-488 BUS IMPLEMENTATION**

**Multiline Commands:** DCL, LLO, SDC, GET, GTL, UNT, UNL, SPE, SPD.

**Uniline Commands:** IFC, REN, EOI, SRQ, ATN.

**Interface Functions:** SH1, AH1, T6, TE0, L4, LE0, SR1, RL1, PP0, DC1, DT1, CO, E1.

**Programmable Parameters:** Display Mode, Output Format, EOI, SRQ, First, Last, Open, Close, Display Channel, Alternate Output, Pole Mode, Date Format, Save/Restore, Reset, I/O Port, Time, Date, Settling Time, Interval Time, Alarm Time, Program Mode, Trigger Mode, Terminator, Self Test.

**Digital I/O Port:** A separate I/O port consisting of eight input and eight output lines as well as common (IEEE-488) and +5VDC. Outputs will drive one TTL load. Inputs represent one TTL load. Mating connector supplied.

**GENERAL**

**DISPLAY:** Six 0.5" LED digits with decimal point, function and IEEE status annunciators.

**OPERATING ENVIRONMENT:** 0° to 50°C, 0% to 80% relative humidity up to 35°C.

**STORAGE ENVIRONMENT:** -25° to 65°C.

**CONNECTORS:** Four BNC; External Trigger, Alarm Out/Serial-In, Channel Ready, Serial Out (TTL compatible).

**POWER:** 105-125V or 210-250V (internal switch selected), 50Hz to 400Hz, 25 V•A maximum. 90-110V and 180-220V version available.

**DIMENSIONS, WEIGHT:** 127mm high × 216mm wide × 359mm deep (5" × 8½" × 14½"). Net weight 3kg (6½ lbs.).

**FRONT PANEL PROGRAMS**

0 - Digital I/O	Read or change state on digital I/O port.
1* - Date Format	Changes date display between MM.DD and DD.MM.
2* - Settle Time	Time to output CHANNEL READY pulse after closing relay.
3* - IEEE Address	Set bus address; cannot be programmed from bus.
4* - Save Setup	Stores present relay setup in numbered (1 - 5) buffer.
5* - Restore Setup	Recalls relay setup in buffer 1 - 5.
6* - Poles	1, 2 or 4-pole configuration for scanning. 0-pole for matrixing.
7 - Alarm Time	Set time for Alarm output pulse; repeats daily.
8 - Self Test	Check RAM, ROM, LEDs.
90* - Stand Alone	Single 705 configuration.
91* - Master	Daisy chain configuration.
92* - Slave	Daisy chain configuration.
99 - Reset	Reset battery backup parameters to factory values.

\*Battery backed up.

**ACCESSORIES AVAILABLE:**

Model 1019A:	Universal Fixed Rack Mounting Kit
Model 1019S:	Universal Slide Rack Mounting Kit
Model 7008-3:	IEEE-488 Cable, 0.9m (3 ft.)
Model 7008-6:	IEEE-488 Cable, 1.8m (6 ft.)
Model 7010:	IEEE-488 Adapter for Model 85 Computer
Model 7024-3:	Triaxial Cable, 0.9m (3 ft.)
Model 7024-10:	Triaxial Cable, 3.0m (10 ft.)
Model 7052:	5×4 Matrix Scanner Card
Model 7053:	5A Current Scanner Card
Model 7054:	High Voltage Scanner Card
Model 7055:	Quick Disconnect Card
Model 7056:	General Purpose Scanner Card
Model 7057A:	Thermocouple Scanner Card
Model 7058:	Low Current Scanner Card
Model 7059:	Low Voltage Scanner Card
Model 7051-2:	2 ft. BNC to BNC Cable
Model 7051-5:	5 ft. BNC to BNC Cable

**7052/5×4 Matrix Scanner Card**

Model 7052 5×4 Matrix Card is a 20-channel general purpose switching card. Up to 200 crosspoints of 3-pole switching can be achieved with Keithley Model 705 Scanner mainframes and the "daisy chain" mode. It is a cost-effective means of matrix switching and a versatile solution to many system application problems. Each channel of the card is a 3-pole relay consisting of three Form A (SPNO) contacts. Switching is accomplished in less than 2 milliseconds.

The flexibility of matrix switching allows the user to connect any of the input channels to any of the outputs singly or in combinations. Ideal for complex signal and measurement device switching, this matrix card can help minimize your need for custom cables and patch panels because the routings can be customized in software. Switched guards assure high isolation between channels.

The screw terminal strip connectors on the Model 7052 accept wire thickness to 18 AWG. Installation and removal are easily done through the rear panel of the scanner mainframe. Random and/or multiple crosspoints may be selected up to the relay drive capability of the 705 mainframe. Crosspoints are uniquely selected and decoded on the 705 mainframe display up to the 200 crosspoint maximum.

**Model 7052 Specifications**

**CROSSPOINTS PER CARD:** 5×4 configuration, 20 crosspoints.

**CONTACT CONFIGURATION:** 3-pole Form A.

**CONNECTOR TYPE:** Screw terminal, #18 AWG maximum wire size.

**RELAY DRIVE CURRENT:** 12mA per relay.

**SIGNAL LEVEL:** 200V, 200mA, 10V•A maximum (resistive load only).

**CONTACT LIFE:** > 10<sup>7</sup> closures at maximum signal levels.

**CONTACT RESISTANCE:** < 1Ω to rated life.

**CONTACT POTENTIAL:** < 50μV per contact pair input to output with copper leads.

**ACTUATION TIME:** < 2ms, exclusive of mainframe.

**CHANNEL ISOLATION:** > 10<sup>12</sup>Ω, < 20pF.

**INPUT ISOLATION, DIFFERENTIAL:** > 10<sup>9</sup>Ω, < 50pF.

**INPUT ISOLATION, COMMON MODE:** > 10<sup>9</sup>Ω, < 100pF.

**COMMON MODE VOLTAGE:** 200V peak.

**GENERAL**

**OPERATING ENVIRONMENT:** 0° to 50°C, up to 35°C at 70% RH.

**STORAGE ENVIRONMENT:** -25°C to 65°C.

**DIMENSIONS, WEIGHT:** 32mm high × 114mm wide × 272mm long (1¼" × 4½" × 10¾"). Net weight 0.61kg (21.5 oz.).

# Scanner Cards

## 7053/5A Current Scanner Card

Model 7053 Current Scanner Card has 10 channels and features 5A contacts. It will switch any one of ten signals to one output, or switch one signal to any one of ten outputs. For automation of laboratory experiments where AC or DC currents must be monitored, the 7053 offers versatility as well as economy of operation. Used with Model 705 mainframes (in the "daisy chain" mode), scanner configurations of up to 100 channels are possible.

Many applications in research and design development labs can be easily automated using the 7053. Semiconductor testing, material research, power supply testing, solar cell measurements, electrochemical applications and IC testing are among the applications simplified with the 7053 Current Scanner Card.

The switching is designed to maintain current paths for signals not connected to the output, or when internal jumpers are removed, to provide high input resistance for making voltage measurements. AC or DC signals up to 5A or 300V may be switched. Quick disconnect screw terminals accept up to 18 AWG wire size.

## Model 7053 Specifications

**CHANNELS PER CARD:** 10.  
**CONTACT CONFIGURATION:** 2-pole Form A.  
**CONNECTOR TYPE:** Screw terminal, #18 AWG maximum wire size.  
**RELAY DRIVE CURRENT:** 70mA per relay.  
**SIGNAL LEVEL:** 300V, 5A maximum, 100V•A, (resistive load only).  
**CONTACT LIFE:** > 10<sup>5</sup> closures at maximum signal levels.  
**CONTACT RESISTANCE:** < 1Ω to rated life.  
**CONTACT POTENTIAL:** < 1mV.  
**ACTUATION TIME:** < 15ms, exclusive of mainframe.  
**CHANNEL ISOLATION:** > 10<sup>9</sup>Ω, < 50pF with internal jumper removed.  
**INPUT ISOLATION:** > 10<sup>9</sup>Ω, < 50pF.  
**COMMON MODE VOLTAGE:** 300V peak.  
**GENERAL**  
**OPERATING ENVIRONMENT:** 0° to 50°C, up to 35°C at 70% RH.  
**STORAGE ENVIRONMENT:** -25°C to 65°C.  
**DIMENSIONS:** 32mm high × 114mm wide × 272mm long (1¼" × 4½" × 10¾").

## 7054/High Voltage Scanner Card

Model 7054 High Voltage Scanner Card is a 10 channel high voltage relay scanner. Voltages up to 1000V rms can be switched in using 1 pole Form A relays. Low is common to all channels and the output.

This high voltage switch can be used to selectively source voltages to any of ten circuits or to monitor voltages from as many sources. Applications include testing of insulation resistance, breakdown, capacitor leakage, dielectric absorption, voltage coefficients, voltage stress, monitoring of line voltages, motor voltages and more.

Up to 100 channels of high voltage switching can be achieved with the 705 mainframe, or the 7054 may be used in combination with other scanner cards for special measurement needs.

## Model 7054 Specifications

**CHANNELS PER CARD:** 10.  
**CONTACT CONFIGURATION:** Single pole Form A, common guard connection.  
**CONNECTOR TYPE:** Quick disconnect screw terminal, No. 18 AWG maximum wire size.  
**RELAY DRIVE CURRENT:** 55mA (per relay)  
**SIGNAL LEVEL:** 1000V maximum at 10mA, 10V•A maximum resistive loads only.  
**CONTACT LIFE:** > 10<sup>5</sup> closures at maximum signal levels.  
**CONTACT RESISTANCE:** < 1Ω.  
**ACTUATION TIME:** < 20ms, exclusive of mainframe.  
**CHANNEL ISOLATION:** > 10<sup>12</sup>Ω and < 10pF.  
**INPUT ISOLATION:** > 10<sup>9</sup>Ω and < 150pF.  
**GUARD TO CHASSIS VOLTAGE:** 200V maximum.  
**GENERAL**  
**OPERATING ENVIRONMENT:** 0° to 50°C, up to 35°C at 70% non-condensing RH.  
**STORAGE ENVIRONMENT:** -25°C to 65°C.  
**DIMENSIONS, WEIGHT:** 32mm × 114mm wide × 272mm long (1¼" × 4½" × 10¾"). Net weight 0.28kg (10 oz.).

## 7056/General Purpose Scanner Card

Model 7056 General Purpose Relay Scanner Plug-in Card is a 10-channel general purpose scanner card. Up to 100 channels of 2-pole switching can be achieved with Keithley Model 705 Scanner mainframes and the "daisy chain" mode. It is a cost-effective means of scanning and a versatile solution to relay switching problems. Each channel of the card has two Form A (SPNO) contacts. Switching is accomplished in less than 2 milliseconds.

Electrical connection is made through the Model 7055 quick disconnect supplied with the scanner card. The screw terminal strip connectors on Model 7055 accept wire thickness up to 18 AWG. Installation and removal are easily done through the rear panel of the scanner mainframe.

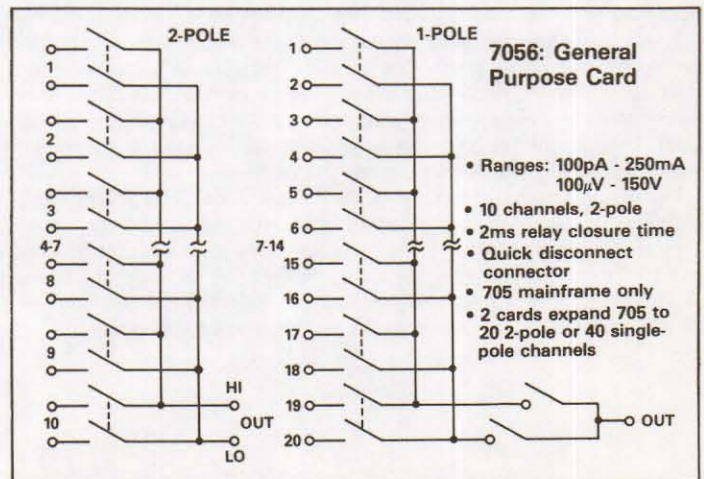



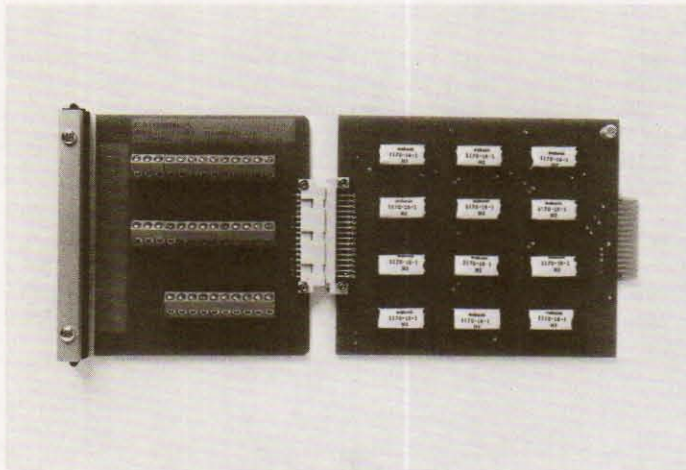

## Model 7056 Specifications

**CHANNELS PER CARD:** 10 in 2-pole mode, 20 in 1-pole mode.  
**CONTACT CONFIGURATION:** 2-pole Form A, includes Model 7055 Quick Disconnect Card. HI or LO switched to a separate output for 1-pole mode, common guard connection.  
**CONNECTOR TYPE:** Screw terminal, #18 AWG maximum wire size. Terminals mounted on 7055 quick disconnect portion of 7056.  
**RELAY DRIVE CURRENT:** 24mA per relay typical.  
**SIGNAL LEVEL:** 150V, 250mA, 10V•A maximum (non-inductive load only).  
**CONTACT LIFE:** >10<sup>6</sup> closures at maximum signal levels.  
**CONTACT RESISTANCE:** < 2Ω to rated life.  
**CONTACT POTENTIAL:** < 100μV per contact pair input to output with copper leads (< 50μV typical).  
**ACTUATION TIME:** < 2ms, exclusive of mainframe.  
**CHANNEL ISOLATION:** > 10<sup>9</sup>Ω, < 50pF.  
**INPUT ISOLATION, DIFFERENTIAL:** > 10<sup>9</sup>Ω, < 50pF.  
**INPUT ISOLATION, COMMON MODE:** > 10<sup>9</sup>Ω, < 150pF.  
**COMMON MODE VOLTAGE:** 150V peak.

## GENERAL

**OPERATING ENVIRONMENT:** 0° to 50°C, up to 35°C at 70% RH.  
**STORAGE ENVIRONMENT:** -25°C to 65°C.  
**DIMENSIONS, WEIGHT:** 32mm high × 114mm wide × 272mm long (1¼" × 4½" × 10¾"). Net weight 0.27kg (9.5 oz.).

## 7057A/Thermocouple Scanner Card

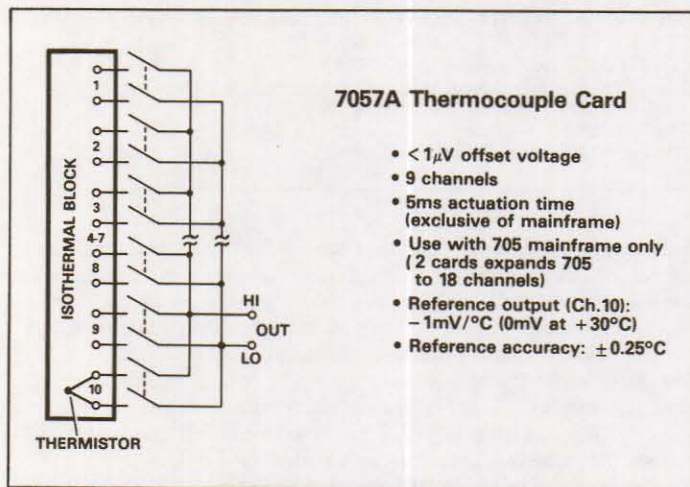

## Model 7057A Specifications

**CHANNELS PER CARD:** 9 plus temperature reference.  
**CONTACT CONFIGURATION:** 2-pole Form A, common guard connection.  
**CONNECTOR TYPE:** Copper screw terminals in isothermal block, No. 18 AWG maximum wire size.  
**RELAY DRIVE CURRENT:** 10mA per relay.  
**TEMPERATURE OFFSET:** ±0.05°C maximum for a reference of temperature 0°C to 50°C. Maximum additional dynamic offset due to 10°C step change in environment: ±0.1°C after 1 hour settling time.  
**TEMPERATURE REFERENCE:** Thermistor in a linearized bridge.  
**REFERENCE OUTPUT:** -1mV/°C (0mV at +30°C).  
**REFERENCE ACCURACY (1 YEAR):** ±0.25°C (10°C to 35°C); ±0.5°C (0°C to 10°C and 35°C to 50°C).  
**CONTACT LIFE:** >10<sup>6</sup> closures.

**Model 7057A Thermocouple Scanner Plug-In Card** permits monitoring of up to nine thermocouples or other transducers. The nine signal channels use a guarded 2-pole configuration, similar to the Model 7059 Low Voltage Card. Used with Model 705 mainframes (in the "daisy chain" mode), scanner configurations of up to 100 channels are possible. All analog connections are made via terminals on the 7057A prior to installation in the mainframe. The 7057A plugs into the rear of the 705 mainframe and can be easily removed for wiring modifications.

The 7057A can be used with a variety of thermocouple types; linearization factors for Types B, E, J, K, R, S and T are provided in the manual. Any combination of thermocouple types may be used. The 7057A has copper terminals and a built-in temperature reference (a thermistor in a linearized bridge) thermally connected in an anodized aluminum isothermal block to minimize thermal offsets.

The reference output (Channel 1) is 1mV/°C with a zero output at 30°C. This reference temperature can then be used to determine the correction factor for the particular thermocouple being used. (The proper correction factor must be used for each type of thermocouple.)

**CONTACT RESISTANCE:** < 2Ω to rated life.  
**CONTACT POTENTIAL:** < 1μV.  
**WARMUP:** 1 hour to rated accuracy.  
**ACTUATION TIME:** < 5ms, exclusive of mainframe.  
**CHANNEL ISOLATION:** > 10<sup>7</sup>Ω, < 100pF.  
**INPUT ISOLATION:** > 10<sup>7</sup>Ω, < 400pF.  
**COMMON MODE VOLTAGE:** 200V peak.

## GENERAL

**OPERATING ENVIRONMENT:** 0° to 50°C, up to 35°C at 70% RH.  
**STORAGE ENVIRONMENT:** -25°C to 65°C.  
**DIMENSIONS, WEIGHT:** 32mm high × 114mm wide × 272mm long (1¼" × 4½" × 10¾"). Net weight 0.54kg (19 oz.).

# Scanner Cards

## 7058/Low Current Scanner Card

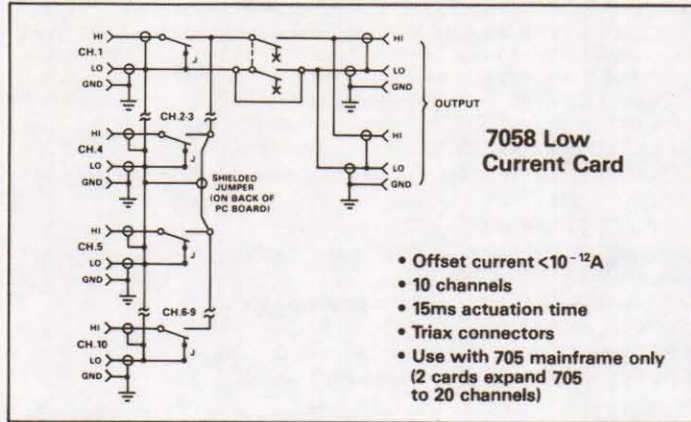

### Model 7058 Specifications

**CHANNELS PER CARD:** 10.

**CONTACT CONFIGURATION:** Single pole, break-before-make for signal HI input. Signal LO is common for all 10 channels. When a channel is off, signal HI is connected to signal LO through an internal jumper.

**CONNECTOR TYPE:** Triaxial.

**RELAY DRIVE CURRENT:** 24mA per relay typical.

**SIGNAL LEVEL:** 28V, 100mA maximum (non-inductive load only).

**CONTACT LIFE:**  $> 10^6$  closures at maximum signal levels.

**CONTACT RESISTANCE:**  $< 1\Omega$  to rated life.

**CONTACT POTENTIAL:**  $< 250\mu$ V.

**ACTUATION TIME:**  $< 15$ ms, exclusive of mainframe.

**CHANNEL ISOLATION:**  $> 10^{15}\Omega$ ,  $< 0.1$ pF with internal jumper removed.

Model 7058 Low Current Scanner Plug-In Card has 10 channels and features low offset current and high isolation between inputs. It will switch any one of ten signals to one output, or switch one signal to any one of ten outputs. For automation of laboratory experiments where multiple AC or DC currents (particularly low currents) must be monitored, the 7058 offers versatility as well as economy of operation.

For optimum low level current switching, the 7058 is designed to introduce minimal offset current error (under 1pA), while guarding ensures that high isolation ( $10^{15}\Omega$ ) is maintained between input signals. AC or DC signals up to 100mA or 28V may be switched. Triaxial input and output connections are easily made using optional triaxial mating cables.

**INPUT ISOLATION:**  $> 10^{10}\Omega$ ,  $< 50$ pF.

**OFFSET CURRENT:**  $< 10^{-12}$ A ( $< 10^{-13}$ A typical).

**COMMON MODE VOLTAGE:** 100V peak.

### GENERAL

**OPERATING ENVIRONMENT:** 0° to 50°C, up to 35°C at 70% RH.

**STORAGE ENVIRONMENT:** -25°C to 65°C.

**DIMENSIONS, WEIGHT:** 32mm high  $\times$  114mm wide  $\times$  272mm long (1¼"  $\times$  4½"  $\times$  10¾"). Net weight 0.54kg (19 oz.).

### ACCESSORIES AVAILABLE:

Model 7024-3: Triaxial Cable, 0.9m (3 ft.)

Model 7024-5: Triaxial Cable, 1.5m (5 ft.)

Model 7024-10: Triaxial Cable, 3.0m (10 ft.)

Model 7023: Female Triaxial Connector

## 7059/Low Voltage Scanner Card

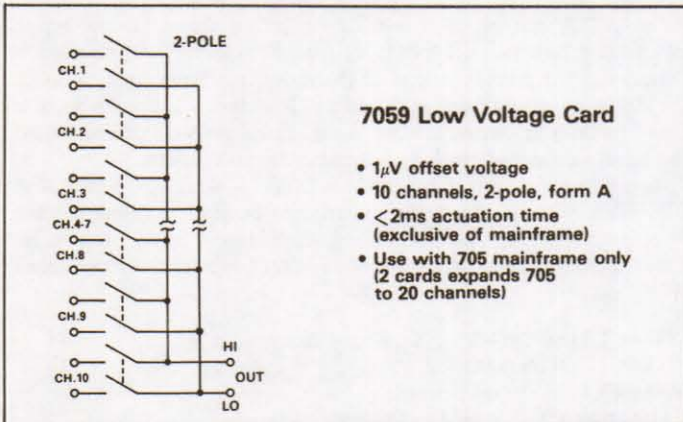

### Model 7059 Specifications

**CHANNELS PER CARD:** 10.

**CONTACT CONFIGURATION:** 2-pole Form A, common guard connection.

**CONNECTOR TYPE:** Screw terminal, #18 AWG maximum wire size.

**RELAY DRIVE CURRENT:** 13mA per relay typical.

**SIGNAL LEVEL:** 200V, 100mA, 2V $\cdot$ A maximum (non-inductive load only).

**CONTACT LIFE:**  $> 10^6$  closures at maximum signal level.

**CONTACT RESISTANCE:**  $< 2\Omega$  to rated life.

**CONTACT POTENTIAL:**  $< 1\mu$ V input to output with copper leads ( $< 200$ nV typical  $< 1$  minute after actuation).

**WARM UP:** 1 hour for thermal stability.

Model 7059 Low Voltage Scanner Plug-In Card has 10 channels and features low thermal offsets and high isolation between inputs. It will switch any one of ten signals to one output, or switch one signal to any one of ten outputs. For automation of laboratory experiments where multiple voltages (particularly low voltages) must be monitored, the 7059 offers versatility as well as economy of operation. For low level transducer switching, the 7059 is designed to introduce thermal voltage errors  $< 1\mu$ V and ensure that high isolation ( $10^{12}\Omega$ ) is maintained between input signals. Switching is accomplished in less than 2 milliseconds. Expected relay life ( $10^6$  closures) is obtained when signals less than 10V or 10mA are switched.

**ACTUATION TIME:**  $< 2$ ms, exclusive of mainframe.

**CHANNEL ISOLATION:**  $> 10^{12}\Omega$ ,  $< 10$ pF.

**INPUT ISOLATION, DIFFERENTIAL:**  $> 10^9\Omega$ ,  $< 50$ pF.

**INPUT ISOLATION, COMMON MODE:**  $> 10^9\Omega$ ,  $< 150$ pF.

**COMMON MODE VOLTAGE:** 200V peak.

### GENERAL

**OPERATING ENVIRONMENT:** 0° to 50°C, up to 35°C at 70% RH.

**STORAGE ENVIRONMENT:** -25°C to 65°C.

**DIMENSIONS, WEIGHT:** 32mm high  $\times$  114mm wide  $\times$  272mm long (1¼"  $\times$  4½"  $\times$  10¾"). Net weight 0.35kg (12½ oz.).

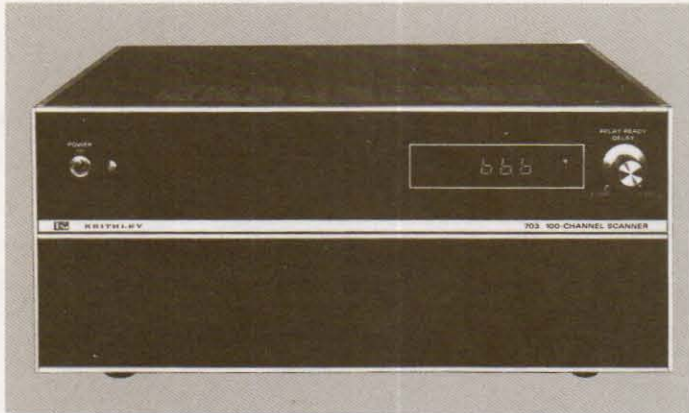

The Model 703 100-Channel Scanner Mainframe is the ideal choice for systems requiring a moderate to large number of signal inputs or outputs. Up to ten 7000-series scanner cards can be used in any combination for up to 100 channels in a single mainframe; multiple 703 mainframes can be connected for up to 1000 channels per scanning system. Multiple active channels in the 703 mainframe may be selected for matrix operation, 4-terminal resistance measurements, capacitor and semiconductor leakage tests, and other applications requiring simultaneous source and sense connections. Individual relay control lines may be paralleled within the 703 so that up to 10 relays can be activated with a single command. Users should select the Model 7033/7031 for use in a Keithley system or with the optional Model 7033 IEEE-488 interface. The Model 703/7032 should be selected when a TTL-compatible, parallel BCD interface is required.

## ACCESSORIES

**Model 7033 IEEE-488 Interface:** Can control up to 10 703s. Device address is switch-selectable.

**Model 7026 General Purpose Relay Scanner Card:** Operation as current scanner, voltage scanner, matrix scanner or independent relay card is determined by easily installed jumpers. Ideal for use in automatic test systems where sources must be switched.

**Model 7027 Thermocouple Scanner Card:** Built-in TC reference consisting of a thermistor in a linearized bridge. An intelligent controller can compute correction factors for TCs referenced to plate temperature & determine TC temperature in °C or °F. Linearization factors provided for TC types B, E, J, K, S and T.

**Model 7028 Low-Current Scanner Card:** Simplifies semiconductor testing, liquid crystal testing, component checkout, IC testing, etc. Guarding ensures at least  $10^{12}\Omega$  isolation between input channels. Single-pole switching maintains currents paths for channels not selected. With internal jumpers removed, the 7028 becomes a voltage scanner card with high input resistance.

**Model 7029 Low-Voltage Scanner Card:** Ideal for thermal measurements, strain gauge monitoring, solar cell experiments and other low-level applications. At least  $10^{12}\Omega$  input resistance is maintained between input signal pairs.

Typical Signal Levels	7026	7027	7028	7029
Current Voltage	100pA-250mA 100 $\mu$ V-200V	3 $\mu$ V-10V	0.1pA-100mA 250 $\mu$ V-28V	3 $\mu$ V-10V
Number of channels per card	10	9	10	10
Connections to Card	Barrier Strip	Copper Screw Terminals	Triax Connectors	Barrier Strip
Maximum active channels/mainframe (w/o external supply)	25	45	10	50
Relay closure time	Less than 5ms	Less than 5ms	Less than 15ms	Less than 5ms
Switching configuration (per channel)	2-pole relay w/one Form A & one Form C contact	2-pole, guarded	Single pole for HI; LO is common for all 10 channels; when channel is off, HI is connected to LO	2-pole, guarded

# Test Fixtures

## Models 8001, 8002, 8003 Test Fixtures

Keithley test fixtures are designed for use with the System Components line of measurement instruments and sources. The fixtures are made of aluminum and have light-tight lids with fasteners. Dimensions of each are 4" high × 6" wide × 4½" deep.



### Model 8001 Semiconductor Test Fixture

Allows convenient semiconductor characterizations with Keithley measurement equipment. Sockets are provided for a bipolar transistor, a MOSFET and a diode.

INPUTS: 3 pair of 5-way binding posts.

OUTPUTS: 4 triaxial connectors.

SUPPLIED CABLES: 3 Model CA-18-1 (for connection to Model 230); 4 Model 7024-5 (for connection to Model 619).

8001

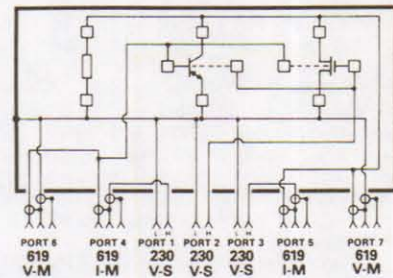

### Model 8002 High Resistance Test Fixture

Enables high resistance measurements up to 100TΩ with a voltage source and current measurement instruments. Because current flow is so minute, the 8002 is designed to minimize leakage currents which could become a significant portion of the measurement if not controlled.

INPUTS: 1 pair of 5-way binding posts.

OUTPUTS: 2 triaxial connectors.

SUPPLIED CABLES: 1 Model CA-18-1 (for connection to Model 230); 2 Model 7024-5 (for connection to Model 619).

8002

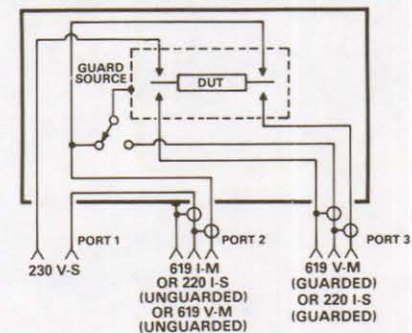

### Model 8003 Low Resistance Test Fixture

Four terminal device which eliminates the effects of test lead resistance by providing separate current source and voltage sensing terminals. The current source may be either the 220 or the ohms source of the Model 192. The voltmeter may be the Model 181 or the ohms sense terminals of the Model 192.

INPUTS: 1 triaxial connector.

OUTPUTS: 2 pairs of 5-way binding posts; 1 special low-thermal connector.

SUPPLIED CABLES: 1 Model 7024-5 (for connection to Model 220); 1 Model 2626 (for connection to Model 181); 2 Model CA-18-1 (for connection to Model 192 ohms source and sense).

8003

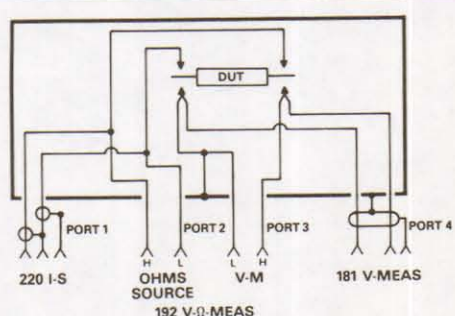

# Controller, Peripherals

KEITHLEY MODEL NUMBER	HP MODEL NUMBER	DESCRIPTION
85	85	<p>The Model 85 is a powerful BASIC language computer with integrated graphics system. Four ports allow you to expand the memory, add enhancement modules and attach peripherals. More than 150 commands and statements are available for problem solving. Enhancement ROMs can add commands and pre-defined functions to the mainframe, increase the capabilities of existing commands, and allow interfacing with peripherals. Memory is expandable to 112K bytes. In addition to the operating features, other built-in features include a typewriter-like alphanumeric keyboard, editing keys, debugging tools and 20-key numeric keypad.</p> <p>The Model 85 has a quiet, bidirectional printer with adjustable intensity that prints two 32-character lines per second, and a built-in tape drive for high-density digital storage of 210K bytes of data or 195K bytes of programs.</p> <p>The Keithley Model 85 comes complete with the following enhancements:</p> <ul style="list-style-type: none"> <li>82903A 16K Memory Module</li> <li>82937A IEEE-488 Interface</li> <li>00085-15005 Advanced Programming ROM: Adds functions, statements and commands for extended control over data, programs and system operations.</li> <li>00085-15001 Mass Storage ROM: Adds 30 operations for complete control and utilization of 82900-Series and 9895A Flexible Disc Memory.</li> <li>00085-15002 Plotter/Printer ROM: Enables interfacing with plotters and printers.</li> </ul>
8504	98200	Tape Cartridges: 210K byte capacity, 42 separate files, 60 IPS search speed, 10 IPS read/write speed. Package of 5.
8505	82931A	Paper for Model 85; 2 rolls, 120m each.
851	82901M	Flexible Disc Drive: Supplies approximately 540K bytes of on-line storage. The unit consists of one master controller with two drives.
8511	92190A	5¼" discs, box of 10.
852	7470A-002	Graphics Plotter: Produces high-quality four-color plots on any size chart up to 210×297mm. Addressable moves may be as small as 0.32mm. The Keithley Model 852 includes the 17601A Option 085 Personality Module to interface with Model 85.
8525	9280-0589	Paper for Model 852 Plotter, 50 sheets.
8526	5060-6810	Multicolor pens for Model 852 Plotter, 4 pens per package.
853	82905B-002	Printer. Operates bidirectionally at 80 characters per second. The 9×9 dot matrix provides a character set with true descending characters. Compressed and expanded modes provide print at 5, 8¼, 10 and 16½ characters per inch, allowing up to 132 characters per line on an 8½-inch page. A special graphics mode allows dot-by-dot control of printing to provide either 72×60 or 72×120 dots per inch. Programmable line spacing allows printing of subscripts and superscripts and specialized forms.
8535	92157A	Paper for Model 853 Printer, 2400 fanfold sheets.
8536	92156A	Ribbon cartridge for Model 853 Printer, package of 2.
854	82939A-001	Serial Interface: Provides RS-232 compatible I/O for communication with printers and terminals. Includes serial interface module with male connector for Model 85, typically used with modems.

For more detailed information, consult individual HP data sheets.

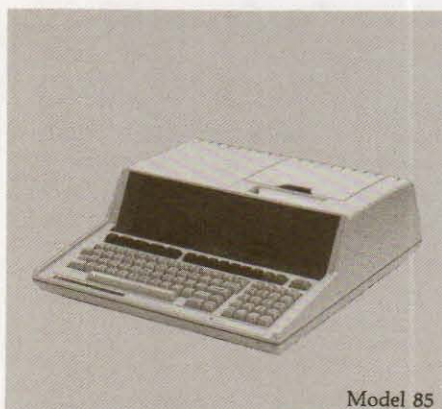

Model 85



Model 851



Model 852



Model 853

# Selector Guide/Digital Multimeters

## Local Distributor Stock

The following instruments are available from stock at distributor locations throughout the U.S. Refer to the distributor listing on page 100, or contact your local Keithley representative for the stocking distributor nearest you.

### Handheld DMMs

Models 128, 130, 131, 132C, 132F, 135A

### Bench DMMs

Models 169, 177, 191

### Thermometers (see pages 36 to 45)

Models 865, 866, 868, 869, 871, 872

## HANDHELD

MODEL	128	130 (131)	132C, 132F	135A
Page	18	17	20	19
Counts	1999	1999	1999	19999
Digits	3½	3½	3½	4½

### DC VOLTS

Sensitivity	1mV	100µV	100µV	100µV
Maximum Reading	1000V	1000V	1000V	1000V
Basic Accuracy	0.5%	0.5% (0.25%)	0.25%	0.05%

### AC VOLTS<sup>2</sup>

Method	Average	Average	TRMS	Average
Sensitivity	1mV	100µV	100µV	100µV
Maximum Reading	750V	750V	750V	750V
Basic Accuracy	1.0%	1.0%	1.0%	1.0%

### OHMS

Special Features	Diode test function.	Diode test on 20kΩ range.	Diode test on 20kΩ range.	Diode test on 20kΩ range.
Sensitivity	100mΩ	100mΩ	100mΩ	100mΩ
Maximum Reading	20MΩ	20MΩ	20MΩ	20MΩ
Basic Accuracy	0.5%	0.5% (0.2%)	0.2%	0.25%

### DC AMPS<sup>2</sup>

Sensitivity	10mA	1µA	1µA	10µA
Maximum Reading	10A	10A	2A	10A
Basic Accuracy	2.0%	1.0% (0.75%)	0.75%	0.25%

### AC AMPS<sup>2</sup>

Method	Average	Average	TRMS	Average
Sensitivity	10mA	1µA	1µA	10µA
Maximum Reading	10A	10A	2A	10A
Basic Accuracy	3.0%	2.0%	2.0%	1.5%

Ranging	Manual	Manual	Manual	Manual
Outputs	—	—	—	—
Battery Operation	Standard	Standard	Standard	Standard
Capsule Comment	Pocket size. 15mm digits. Rugged case. Audible tone threshold detector.	Pocket size. 15mm digits. Rugged case. 0.25% accuracy on Model 131.	Only handheld DMM with both TRMS and temperature capability.	Pocket size. 15mm digits. Rugged case. 4½ digits.

<sup>1</sup>TRMS or average-responding options available on Models 191 and 192.

<sup>2</sup>Optional on Model 195.

# Digital Multimeters/Selector Guide

## BENCH

169	179A	177	191
22	24	26	28
1999	19999	19999	199999
3½	4½	4½	5½

100µV	10µV	1µV	1µV
1000V	1200V	1200V	1200V
0.25%	0.04%	0.03%	0.007%

Average	TRMS	TRMS	Avg/TRMS <sup>1</sup>
100µV	10µV	10µV	10µV
1000V	1000V	1000V	1000V
0.75%	0.5%	0.5%	0.1%

Diode test on 20kΩ range	HI-LO switch selectable	Front panel lead compensation	Auto 2/4 terminal
100mΩ	100mΩ	1mΩ	1mΩ
20MΩ	20MΩ	20MΩ	20MΩ
0.2%	0.04%	0.04%	0.012%

100nA	10nA	1nA	—
2A	20A	2A	—
0.75%	0.2%	0.2%	—

Average	TRMS	TRMS	—
100nA	10nA	10nA	—
2A	20A	2A	—
1.5%	1.0%	0.8%	—

Manual	Manual	Manual	Manual
—	IEEE-488 or BCD option.	IEEE-488 or BCD option. Analog std.	—
Standard. Line option.	Optional	Optional	—
Function & range annunciators. 0.6" digits. 1-year battery. Float up to 1.4kV.	1kV protection on Ω. Float up to 1.4kV. 20A AC, DC current.	1µV, 1nA, 1mΩ sensitivity. Analog output.	µP control. Digital filter. Pushbutton null.

## SYSTEMS

192	195
30	32
1999999	199999
5½-6½	5½

1µV	100nV
1200V	1000V
0.005%	0.025%

Avg/TRMS <sup>1</sup>	TRMS
10µV	1µV
1000V	700V
0.1%	0.3%

Auto 2/4 terminal	Auto 2/4 terminal
1mΩ	100µΩ
20MΩ	20MΩ
0.007%	0.025%

—	100pA
—	2A
—	0.09%

—	TRMS
—	1nA
—	2A
—	0.6%

Auto/Manual	Auto/Manual
IEEE-488 option.	IEEE-488 std.
—	—
Front panel math functions. Pushbutton zero. Fully programmable with IEEE-488 interface.	Fully programmable. Digital cal over bus. Selectable front/rear inputs. Data storage & analysis.

Prices and specifications subject to change without notice.

# Technical Data/Digital Multimeters

Digital multimeters convert analog signals to digital information. The typical five-function DMM measures DC volts, DC amps,

ohms, AC volts and AC amps. While the specifics may vary, virtually every DMM is developed around the same block diagram (Figure 1).

FIGURE 1

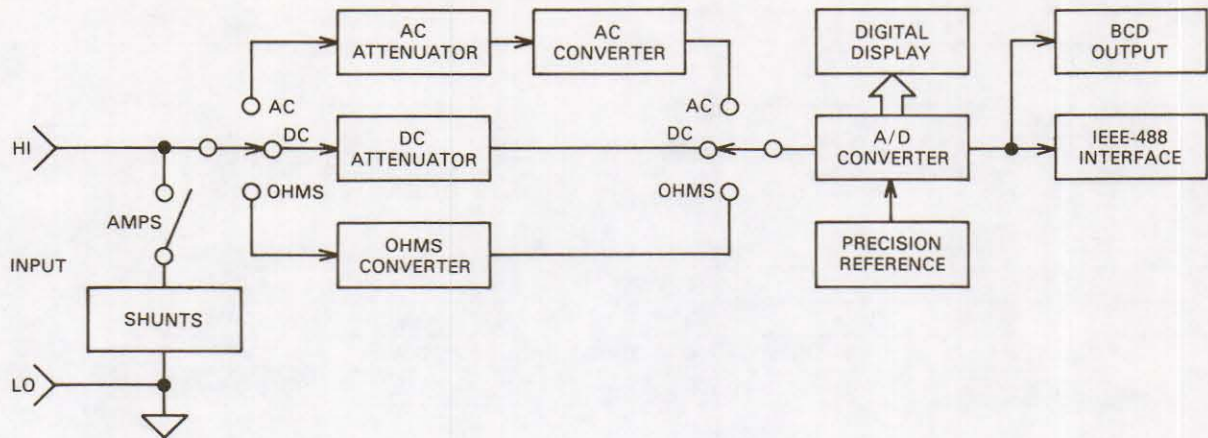

## Analog-to-Digital Conversion

At the heart of every DMM is the A/D converter. Basically, the A/D converts an analog input signal to some kind of digital output. The digital output can be a digital display, IEEE-488 standard interface or BCD output. The A/D converter is largely responsible for the performance characteristics of any DMM.

Low-cost handheld DMMs use a single-chip, 3½-digit A/D converter. High-accuracy 5½-digit meters use a microprocessor-controlled discrete A/D. 4½-digit meters are a tradeoff between 5½-digit performance and 3½-digit price. 4½-digit A/D converters may be discrete or LSI circuits.

## Resolution

The number of digits a DMM can display is the first indication of the resolution of the meter. The number of digits is usually expressed as a

whole number and a fraction (e.g., 3½ or 3¾). The whole number is the number of nines the meter is able to display. The fraction indicates that another digit can be displayed but it will not be a full (0 to 9) digit. A "½" indicates that the most significant digit (MSD) can be a zero (usually blanked) or a one. A "¾" indicates that the MSD can be a zero, one, two or three. A 3½-digit DMM can display from 0 to 1999, a total of 2000 counts. The resolution of the meter is the ratio of the least number of counts that can be displayed to the maximum number of counts that can be displayed. For a 3½-digit DMM this is 1/2000 or 0.05%.

Figure 2 compares two generic DMMs. One is 3½ digits; the other is 4½ digits, and the accuracy will be assumed to be ±(0.1% + 1 count) for both meters.

FIGURE 2

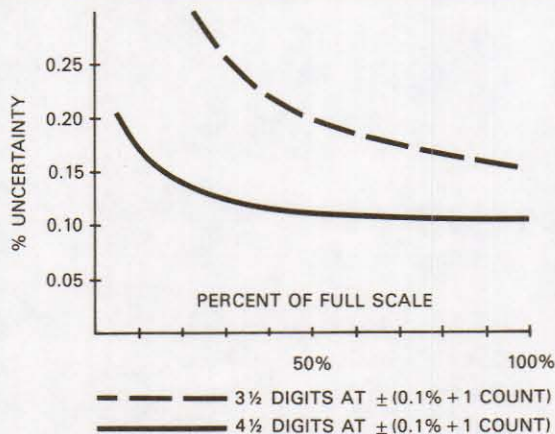

READING UNCERTAINTY

VOLTAGE LEVEL	% OF FULL SCALE	3½ DIGITS ±(0.1% + 1 count)	4½ DIGITS ±(0.1% + 1 count)
1V	5%	1.1 %	0.2 %
5V	25%	0.3 %	0.12 %
10V	50%	0.2 %	0.11 %
19V	95%	0.15%	0.105%

Note how increased resolution improves instrument performance, even though accuracies are identical.

## Sensitivity

Sensitivity refers to the smallest incremental voltage change the instrument can detect. A 3½-digit DMM with a 200mV full scale range has 100µV sensitivity. Sensitivity of 1µV is generally available in

5½-digit DMMs; 4½-digit DMMs are offered with 1µV, 10µV or 100µV sensitivities. 3½-digit DMMs are generally service-oriented instruments, so 100µV sensitivity is sufficient.

## Accuracy

Accuracy is one of the most important specifications a DMM can offer, and it is specified as "percent of the reading" plus "X number of counts".



In order for the accuracy specification to be meaningful, it must be specified in consideration of environmental conditions and time. The accuracy needs to be specified with time because the components making up the DMM have a stability associated with time. Parts with a short time stability will increase the frequency with which calibration needs to be done. For most handheld and bench DMMs, the time stability of the parts allows the meter to be within its accuracy specifications for at least one year.

Environmental conditions such as temperature and humidity will also change the accuracy of the meter. Most DMM manufacturers specify their instruments to work from 0°C to 50°C, but the published accuracy specification is only true in the normal operating environment of 18°C to 28°C. A derating factor called the temperature coefficient must be applied to the meter when above or below the normal operating temperature range. The temperature coefficient is expressed as a change in accuracy for every °C change in temperature above or below the normal operating temperature range.

## Displays

DMMs invariably require some type of digital readout. Light-emitting diodes (LEDs) are popular for line-powered instruments because they are easy to drive and provide good visibility in dimly lit areas. However, high power consumption combined with poor visibility in direct sunlight makes LEDs unsuitable for portable service instruments.

Liquid crystal displays (LCDs) are much better suited to portable instrumentation. LCD operation involves aligning molecules with a polarizer to prevent light from passing through. They require very little power, due to the fact that they generate no light of their own. Also, by their very design they work best in bright light.

The disadvantages of LCDs are that complex waveforms are required to drive them, and they have slower response, particularly at low temperatures.

## Loading/Input Impedance

Loading is the term given to the disturbance of the circuit being measured by the meter being used. It is caused by the finite input impedance of the DMM. Input impedance is the equivalent resistance and capacitance looking into the DMM at the input terminals. With today's technology, it ranges from 10MΩ and up of resistance and 100pF or less of capacitance.

During a measurement, the DMM is placed in parallel with the part of the circuit being measured and causes an error. An example is a 1VDC source and two 100kΩ resistors to ground.

Mathematically, we know the voltage across either resistor is exactly 0.5V; however, when we measure the voltage across one of the resistors, we get 0.497. This is an error of 0.5% and is caused by the input impedance of the DMM. By placing the DMM across the 100kΩ resistor, the circuit changes accordingly.

The capacitance that is part of the input impedance doesn't affect the accuracy of the DC measurement, but can affect AC measurements if the frequency of the signal is high. If the circuit just discussed were an AC circuit, for instance, the signal frequency would have to be 3210Hz for the capacitance portion of the input impedance to contribute another 0.5% error. For both AC and DC measurements, the amount of error caused by loading decreases as the resistance in the circuit decreases. If the 100kΩ resistors were 10kΩ resistors, the error would be reduced by a factor of ten.

Analogous to loading in the voltage mode is voltage burden in the current mode. Voltage burden is the maximum voltage that will be developed across the DMM when the full scale current is applied. It occurs because DMMs measure current by inserting a precision resistor in series with the incoming current and measure the voltage developed across this resistor. This causes a change in the current through the circuit, but if the resistor is kept small enough and if large currents from a low voltage are not being measured, the error

caused by the voltage burden will be small.

## Ohmmeter Full Scale Voltage

Full scale voltage is the term used to describe the maximum voltage present at the test leads in the ohms function when the full scale resistance is across them. The full scale voltage becomes important when in-circuit resistance or semiconductor junctions are going to be checked. When doing in-circuit resistance checks, the full scale voltage should be well below the turn-on voltage of the semiconductor junctions. This will prevent an error in the reading if the resistor being measured is in parallel with a diode. (Remember that a diode has a finite resistance, and caution should be used when attempting to measure large value resistors that are in parallel with semiconductors.) The full scale voltage must be known if semiconductor junctions such as diodes, Darlington's and LEDs are going to be checked. A larger full scale voltage is required to turn on the junctions. Some meters have a HI-LO feature which allows the user to select the LO setting for in-circuit resistance tests or the HI setting for checking LEDs, diodes and Darlington's.

## Speed of Response and Settling Time

The speed of response of a DMM controls how fast a change in the reading can be detected. Frequently it will be found that the speed of response changes from function to function, DCV usually being the fastest at about 1 second. Ohms may take up to 5 seconds or more to respond on the 20MΩ range.

## Normal Mode and Common Mode Rejection

External interference (noise) in the input can interfere significantly with the measurement being taken. It is important to reject as much of this interference as possible. There are two specifications that describe interference rejection: the normal mode rejection ratio (NMRR) and the common mode rejection ratio (CMRR).

Normal mode interference is that which is mixed with the incoming signal. Most normal mode interference is line frequency interference, although interference of other frequencies is not uncommon.

The amount of rejection while making DC measurements is specified as a normal mode rejection ratio and is specified in decibels (dB). A dB is the unit for describing two intensities, and in the case of NMRR and CMRR, it is given by the equation  $\text{dB} = 20 \log(\text{peak output deviation/peak input interference})$ . NMRR is usually specified at 50Hz and 60Hz. This means that the amount of normal mode rejection specified will only occur if the normal mode interference is at 50Hz frequencies, because it is usually power line related.

An NMRR of 46dB means that the incoming interference will be reduced by a factor of 200. For every increase or decrease of 6dB to the NMRR specification, the attenuation of the noise doubles or halves respectively. If the NMRR were 52dB, the attenuation would increase by a factor of 400. If the NMRR were 58dB, the attenuation would be 800.

Common mode interference is so named because it appears in common to both the high and low inputs of the DMM. The common mode rejection ratio (CMRR) is usually specified at DC, 50Hz and 60Hz. It is the ability of the meter to reject signals common to both inputs. The error occurs due to capacitive coupling of the circuitry inside the DMM to earth ground.

Most DMM manufacturers measure CMRR with a 1kΩ resistive imbalance in the low signal lead. The resistive imbalance is used to simulate an actual in-circuit measurement. A large resistive imbalance will make the CMRR appear worse than the CMRR with a low resistive imbalance. If, for example, the imbalance is 100Ω, the CMRR will appear to be better by 20dB than if the imbalance is 1kΩ. Similarly, if the imbalance is 10kΩ, the CMRR will appear lower by 20dB than the 1kΩ imbalance.

## Signal Conditioning

Once the A/D converter has been established, signal conditioning is a matter of converting resistance or AC volts to the proper DC level.

Ohms can be measured by sourcing a precision current through

# Technical Data/Digital Multimeters

the unknown resistor, and then measuring the voltage drop across the resistor. Lower-cost DMMs source the current through the measuring test leads, terminating at the HI-LO inputs of the DMM. This two-wire ohms system works fine for 3½-digit and most 4½-digit DMMs. However, the I-R drop in the test leads alone can cause inaccuracies that become apparent on 5½-digit models. This led to the development of the four-wire ohms circuit. Four-wire ohms allows one pair of test leads to be the current source conductors, and the other pair to be the sense lines which measure the voltage drop across the unknown resistor. The only current flowing in the sense leads for this configuration is the input current of the A/D converter, which is in the picoampere range.

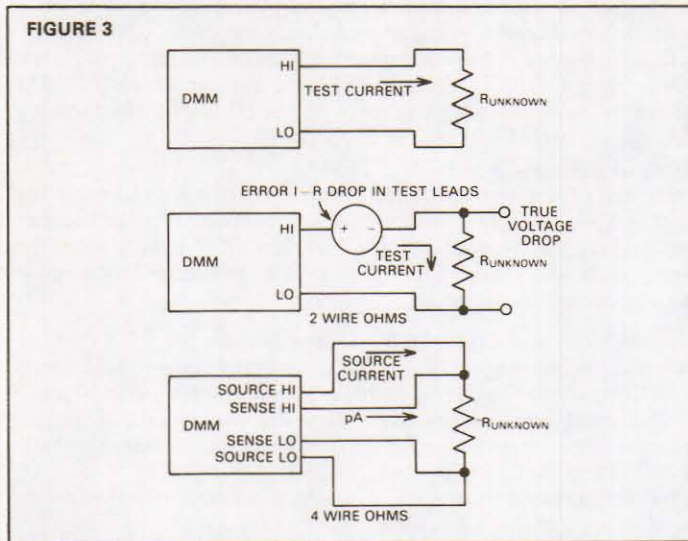

Microprocessor-based instruments such as the Keithley Model 191 also incorporate an offsetting function. The input to the DMM that is present when this null function is activated becomes the new zero reference point. One use for this function is to null out the effects of the test lead resistance before making a measurement. The leads are touched together and the null button is pressed. This will cause the display to read zero, and will essentially subtract the test lead resistance from the measured signal for as long as the null function is activated.

## Overload Protection

Overload protection fits into the category of electrical ruggedness and should be examined closely. It's there to protect the meter from accidental overloads on volts, ohms and amps. The overload protection should be ample enough to protect the meter from line voltages commonly encountered. Typically, the most susceptible ranges for high voltage are the lowest voltage range (200mV) and the ohms ranges.

Along the same line as overload protection is the maximum common mode voltage at which the meter can be used. Common mode voltage is the voltage the meter may be floated at safely, or the maximum voltage the common terminal may be from earth ground. A safety hazard exists for instruments operated above this maximum. The safest way to measure large voltages is to put common of the meter to earth ground whenever possible.

We've gone through most of the terms associated with DMMs, but there are also considerations for extra DMM features available, especially with so many models on the market. Two of these features are audible indicators and true RMS AC capability.

Audible indicators are very helpful for the serviceman who needs to watch his hands and not the display. Some DMM "beeper" models can be used as high impedance logic probes and as continuity testers.

## True RMS and Average Responding Meters

True RMS and average responding meters are terms given to the way a DMM responds to an AC input. When making AC measurements, all DMMs present the amplitude of the AC signal in terms of the RMS value, but few actually measure the RMS value itself. (RMS stands for Root Mean Squared which can be thought of as the DC voltage or current that will generate, in a resistive circuit, the same amount of energy as the AC waveform. Average value stands for the DC voltage or current amplitude that will transfer the same electrical charge to a capacitor as the AC waveform during half a period.)

With an average responding meter, some additional error will result if a square or triangular waveform is being measured. In most cases an average responding meter will give very satisfactory performance at a price much lower than that of a true RMS meter.

**FIGURE 4**

WAVEFORM	RMS VALUE OF WAVEFORM	TRUE RMS READING	AVERAGE DMM READING	ERROR FOR AVG. METER
SINE	14.14V	14.14V	14.14V	0%
SQUARE	10.00V	10.00V	11.11V	11.1%
TRIANGULAR	5.77V	5.77V	5.55V	3.8%

## Outputs

Several useful outputs other than the digital display are available on Keithley DMMs. The Model 177 4½-digit DMM has 1µV resolution and an analog output. The analog output easily interfaces to modern analog recorders, enabling the 177 to act as an amplifier (for µV signals), an attenuator (for kV signals), or a converter to DCV (for AC, current and resistance signals).

With the advance of digital computers, DMMs with some type of digital output have become increasingly useful. Keithley Models 177 and 179A have optional binary coded decimal (BCD) digital outputs. In addition, these models have optional IEEE-488 capability: data output on Models 177 and 179A, and data output, range and function programmability on Models 192 and 195. All of these digital outputs are optically isolated from the analog circuitry, eliminating the problem of common mode voltage.

IEEE-488 compatible instruments are ideal for use with many low-cost controllers, including PET, Apple, Hewlett-Packard and DEC minicomputers. Selecting the proper DMM and adding a low-cost controller allows a completely automated test system to be assembled easily and inexpensively.

## Power

DMMs can be powered in a number of ways. Handheld meters run on a disposable 9V battery. Typical battery life is 200 hours from an alkaline cell. Some bench meters offer extended life (up to 2000 hours) from disposable batteries. All microprocessor-based instruments or instruments with digital outputs are line-operated. These are generally high-resolution, high-sensitivity instruments.

Many Keithley DMMs have provisions for field installation of a rechargeable battery pack. This assures isolation from the power line and allows some degree of portability. The Ni-Cd batteries in these packs will power a typical bench instrument for six hours.

# Digital Multimeter/130, 131

3½-Digit LCD Handheld

- DC volts, DC amps, ohms, AC volts, AC amps
- 10A current range
- Easy-to-use rotary switches

The Keithley Models 130 and 131 are convenient handheld DMMs. Their small size and light weight make them ideal for field service applications which require a portable meter. The difference between the two meters is increased accuracy and extended frequency with the Model 131. With five functions—DC volts, AC volts, DC amps, AC amps and resistance—these DMMs meet many measurement requirements. Diode checks are easily made on the 20kΩ range.



## DC VOLTS

RANGE	RESOLUTION	ACCURACY (1 YEAR) ±(%rdg + digits) 18°-28°C
200mV	100 μV	±(0.5% + 1d)*
2 V	1mV	
20 V	10mV	
200 V	100mV	
1000 V	1 V	

\*0.25% on Model 131

**MAXIMUM ALLOWABLE INPUT:** 1000V DC or peak AC non-switched, 750V peak switched.

**INPUT RESISTANCE:** 10MΩ.

**NORMAL MODE REJECTION RATIO:** Greater than 46dB at 50Hz, 60Hz.

**COMMON MODE REJECTION RATIO:** Greater than 100dB at DC, 50Hz and 60Hz (1kΩ unbalance).

## AC VOLTS

RANGE	RESOLUTION	ACCURACY (1 YEAR)** ±(%rdg + digits) 18°-28°C	FREQUENCY RANGE
200mV	100 μV	±(1% + 5d)*	45Hz-500Hz
2 V	1mV		45Hz-500Hz
20 V	10mV		45Hz-500Hz
200 V	100mV		45Hz-120Hz***
750 V	1 V		45Hz-120Hz***

\*±(1% + 3d) on Model 131 \*\*Above 10 counts \*\*\*45Hz-500Hz on Model 131

**MAXIMUM ALLOWABLE INPUT:** 1000V peak non-switched, 750V peak switched; continuous except 200mV range; 15s max above 300V.

**INPUT IMPEDANCE:** 10MΩ shunted by less than 100pF.

**RESPONSE:** Average responding, calibrated in rms of a sine wave.

## GENERAL

**DISPLAY:** 0.6" LCD digits with decimal and polarity indications, low battery warning.

**OVERRANGE INDICATION:** 3 least significant digits blanked.

**MAXIMUM COMMON MODE VOLTAGE:** 500V peak.

**OPERATING ENVIRONMENT:** 0° to 50°C; less than 70% relative humidity up to 35°C, linearly derate 3% RH/°C from 35°C to 50°C.

**STORAGE ENVIRONMENT:** -35°C to 60°C.

**TEMPERATURE COEFFICIENT (0° to 18°C and 28° to 50°):** Less than 0.1% × applicable accuracy specification per °C.

**POWER:** 9V alkaline or carbon-zinc battery (NEDA 1604).

**BATTERY LIFE:** 100 hours typical with carbon-zinc cells, 200 hours with alkaline cells.

**BATTERY INDICATOR:** Display indicates BAT when less than 10% of life remains.

**DIMENSIONS, WEIGHT:** 178mm long × 78mm wide × 38mm thick (7.0" × 3.1" × 1.5"). Net weight 283gm (10 oz.).

**ACCESSORIES SUPPLIED:** Battery, test leads and operating instructions.

## DC AMPS

RANGE	RESOLUTION	ACCURACY (1 YEAR) ±(%rdg + digits) 18°-28°C	MAXIMUM FULL SCALE VOLTAGE BURDEN
2mA	1 μA	±(1% + 1d)*	0.25V
20mA	10 μA	±(1% + 1d)*	0.25V
200mA	100 μA	±(1% + 1d)*	0.25V
2000mA	1mA	±(2% + 1d)	0.7 V
10 A	10mA	±(2% + 1d)	0.3 V

\*±(0.75% + 1d) on Model 131

**OVERLOAD PROTECTION:** mA input: 2A fuse (250V), externally accessible; 10A input: 20A for 15s unfused.

## AC AMPS

RANGE	RESOLUTION	ACCURACY (1 YEAR)** ±(%rdg + digits) 18°-28°C (45Hz-500Hz)	MAXIMUM FULL SCALE VOLTAGE BURDEN
2mA	1 μA	±(2% + 5d)*	0.25V
20mA	10 μA	±(2% + 5d)*	0.25V
200mA	100 μA	±(2% + 5d)*	0.25V
2000mA	1mA	±(3% + 5d)	0.7 V
10 A	10mA	±(3% + 5d)	0.3 V

\*±(2% + 2d) on Model 131 \*\*Above 10 counts

**OVERLOAD PROTECTION:** mA input: 2A fuse (250V), externally accessible; 10A input: 20A for 15s unfused.

## OHMS

RANGE	RESOLUTION	ACCURACY (1 YEAR) ±(%rdg + digits) 18°-28°C	FULL SCALE VOLTAGE
200 Ω	100mΩ	±(0.5% + 4d)	<0.5V
2 kΩ	1 Ω	±(0.5% + 1d)*	<0.5V
20 kΩ	10 Ω	±(0.5% + 1d)*	>0.7V
200 kΩ	100 Ω	±(0.5% + 1d)*	>0.7V
20MΩ	10 kΩ	±(2% + 1d)	>0.7V

\*±(0.2% + 1d) on Model 131

**MAXIMUM OPEN CIRCUIT VOLTAGE:** 1.5V.

**MAXIMUM ALLOWABLE INPUT:** 300V DC or rms.

## ACCESSORIES AVAILABLE:

- Model 1301: Temperature Probe
- Model 1304: Soft Carrying Case & Stand
- Model 1306: Deluxe Carrying Case
- Model 1309: Spare Parts Kit
- Model 1600A: High Voltage Probe
- Model 1651: 50-Ampere Current Shunt
- Model 1681: Clip-On Test Lead Set
- Model 1682A: RF Probe
- Model 1683: Universal Test Lead Kit
- Model 1685: Clamp-On Current Probe
- Model 1691: General Purpose Test Lead Set

# 128/Digital Multimeter

## Threshold Indication

- Multifunction beeper—works on volts, amps and ohms
- Diode test suitable for LEDs and Darlingtonts
- 0.5% accuracy

The Model 128 Digital Multimeter shares other Keithley handhelds' rugged mechanical package, and adds additional features designed to satisfy the needs of both bench and field service users. Among these features is a beeper which audibly signals when a resistance is below a threshold or when a current or voltage is above a threshold. This feature allows the serviceman to make a diagnosis without removing his eyes from the equipment being tested.

The 128 maintains high input impedance (suitable for CMOS) and keeps the display active. The beeper may be disabled with a side mounted slide switch. Always present is a visual display of ↑ (above threshold) or ↓ (below threshold).

The diode test position will check multiple junctions, so it can be used on Darlingtonts and LEDs as well as single diodes. All calibration adjustments, including the threshold adjustment potentiometer, are externally accessible through a rear cover.



### DC VOLTS

RANGE	RESOLUTION	ACCURACY (1 YEAR) ±(% rdg + digits) 18°-28°C
2V	1mV	±(0.5% + 1d)
20V	10mV	
200V	100mV	
1000V	1 V	

**MAXIMUM ALLOWABLE INPUT:** 1000V DC or peak AC.

**INPUT RESISTANCE:** 10MΩ.

**NORMAL MODE REJECTION RATIO:** Greater than 46dB at 50Hz, 60Hz.

**COMMON MODE REJECTION RATIO:** Greater than 100dB at DC, 50Hz and 60Hz (1kΩ unbalance).

### AC VOLTS

RANGE	RESOLUTION	ACCURACY (1 YEAR) ±(% rdg + digits) 18°-28°C	FREQUENCY RANGE
2V	1mV	±(1% + 5d)	45Hz-500Hz
20V	10mV		45Hz-500Hz
200V	100mV		45Hz-500Hz
750V	1 V		45Hz-500Hz

**MAXIMUM ALLOWABLE INPUT:** 1000V peak.

**INPUT IMPEDANCE:** 10MΩ shunted by less than 100pF.

**RESPONSE:** Average responding, calibrated in rms of a sine wave.

### OHMS

RANGE	RESOLUTION	ACCURACY (1 YEAR) ±(% rdg + digits) 18°-28°C	FULL SCALE VOLTAGE
200 Ω	100mΩ	±(0.5% + 3d)	< 0.3V
20 kΩ	10 Ω	±(0.5% + 1d)	< 0.3V
2MΩ	1kΩ	±(0.5% + 1d)	< 0.4V
20MΩ	10kΩ	±(2% + 1d)	< 0.4V

**DIODE TEST:** On-scale reading for 1 or 2 forward biased silicon diodes (@ 1mA).

**MAXIMUM OPEN CIRCUIT VOLTAGE:** 3.2V on diode test and 200Ω ranges; 0.8V on all other ranges.

**MAXIMUM ALLOWABLE INPUT:** 300V DC or rms.

### DC AMPS

RANGE	RESOLUTION	ACCURACY (1 YEAR) ±(% rdg + digits) 18°-28°C	MAXIMUM FULL SCALE VOLTAGE BURDEN
10A	10mA	±(1.5% + 1d)	0.3V

**MAXIMUM ALLOWABLE INPUT:** 20A for 15 seconds (unfused).

### AC AMPS

RANGE	RESOLUTION	ACCURACY (1 YEAR) 45Hz-500Hz 18°-28°C	MAXIMUM FULL SCALE VOLTAGE BURDEN
10A	10mA	±(2% + 5d)	0.3V rms

**MAXIMUM ALLOWABLE INPUT:** 20A for 15 seconds (unfused).

### THRESHOLD DETECTOR

Display indicates above (↑) or below (↓) the set threshold on any range. An audio tone (switch enabled) sounds for a voltage or current above the threshold or a resistance below the threshold. Threshold is adjustable from +0.5% to +15% of full scale on volts, amps and the 200Ω range.

### GENERAL

**DISPLAY:** 3½-digit LCD, 15mm (0.6") height, with polarity and range indication.

**OVERRANGE INDICATION:** 3 least significant digits blanked.

**MAXIMUM COMMON MODE VOLTAGE:** 500V peak.

**OPERATING ENVIRONMENT:** 0° to 50°C; less than 80% relative humidity up to 35°C; linearly derate 3% RH/°C, 35° to 50°C.

**STORAGE ENVIRONMENT:** -35° to 60°C, less than 90% relative humidity up to 35°C; linearly derate 3% RH/°C, 35°C to 50°C.

**TEMPERATURE COEFFICIENT (0°-18°C & 28°-50°C):** Less than 0.1 × applicable accuracy specification/°C.

**POWER:** 9V alkaline or C-Zn battery (NEDA 1604).

**BATTERY LIFE:** 200 hours typical with C-Zn cells; 350 hours with alkaline cells.

**BATTERY INDICATOR:** Display indicates "BAT" when less than 10% of life remains.

**DIMENSIONS, WEIGHT:** 178mm long × 76mm wide × 38mm thick (7" × 3" × 1.5"). Net weight, 315gm (11 oz.).

**ACCESSORIES SUPPLIED:** Test leads, battery, operator's manual.

### ACCESSORIES AVAILABLE:

- Model 1301: Temperature Probe
- Model 1304: Soft Carrying Case & Stand
- Model 1306: Deluxe Carrying Case
- Model 1600A: High Voltage Probe
- Model 1681: Clip-On Test Lead Set
- Model 1682A: RF Probe
- Model 1683: Universal Test Lead Kit
- Model 1685: Clamp-On Current Probe
- Model 1691: General Purpose Test Leads

# Digital Multimeter/135A

4½-Digit LCD Handheld

- 0.05% DCV accuracy
- 50mA and 10A current range
- Fully protected

Keithley's revolutionary Model 135A Digital Multimeter is both the most precise handheld DMM on the market and the lowest priced 4½-digit instrument ever made. Compared to ordinary handhelds, the 135A has 3 to 4 times better accuracy and 10 times better resolution.

The 135A shares other Keithley handhelds' rugged construction. The entire package is encased in 2.5mm (0.1") thick impact-resistant plastic. The LCD is protected by a tough, scratch-resistant window. Even the front panel overlay is printed on the back surface to make the labeling wear-proof.

The 135A has five functions: DCV, ACV, DCA, ACA and ohms. Diode checks are easily made on the 20kΩ range.



## DC VOLTS

RANGE	RESOLUTION	ACCURACY (1 YEAR) ±(%rdg + digits) 18°-28°C	TEMPERATURE COEFFICIENT ±(%rdg + digits)/°C 0°-18°C & 28°-50°C
2 V	100 μV	0.05% + 1d	0.012% + 0.3d
20 V	1mV	0.05% + 1d	0.012% + 0.3d
200 V	10mV	0.1% + 1d	0.012% + 0.3d
1000 V	100mV	0.1% + 1d	0.012% + 0.3d

INPUT RESISTANCE: 10MΩ.

NORMAL MODE REJECTION RATIO: Greater than 60dB @ 50Hz, 60Hz.

COMMON MODE REJECTION RATIO (1kΩ unbalance): Greater than 120dB @ DC, 50Hz & 60Hz.

MAXIMUM ALLOWABLE INPUT: 1000V DC or peak AC non-switched, 750V peak switched.

## AC VOLTS

RANGE	RESOLUTION	ACCURACY (1 YEAR) ±(%rdg + digits) 18°-28°C
2 V	100 μV	1% + 15d, 45Hz-10kHz*
20 V	1mV	1% + 15d, 45Hz-500 Hz
200 V	10mV	1% + 15d, 45Hz-120 Hz
750 V	100mV	1% + 15d, 45Hz-120 Hz

\*Above 2000 counts.

Extended range accuracy: 5% + 15d, 10kHz-20kHz

RESPONSE: Average responding, calibrated in rms of a sine wave.

INPUT IMPEDANCE: 10MΩ shunted by less than 100pF.

COMMON MODE REJECTION RATIO (1kΩ unbalance): Greater than 60dB @ DC, 50Hz & 60Hz.

MAXIMUM ALLOWABLE INPUT: 750V rms, 1000V peak continuous on 20V, 200V, 750V ranges, 10°V•Hz max; 300V rms continuous, 750V momentary (3 seconds) on 2V range

TEMPERATURE COEFFICIENT: Less than (0.1×applicable accuracy)/°C (0°-28°C & 35°-50°C).

## OHMS

RANGE	RESOLUTION	ACCURACY (1 YEAR) ±(%rdg + digits) 18°-28°C	TEMPERATURE COEFFICIENT ±(%rdg + digits)/°C 0°-18°C & 28°-50°C	MAXIMUM TEST CURRENT
2 kΩ	100mΩ	0.25% + 5d	0.05% + 0.3d	-750 μA
20 kΩ	1 Ω	0.2% + 2d	0.01% + 0.5d	-150 μA
200 kΩ	10 Ω	0.2% + 2d	0.01% + 0.5d	-15 μA
2000 kΩ	100 Ω	0.2% + 2d	0.01% + 0.5d	-1.5 μA
20MΩ	1 kΩ	1% + 2d	0.1% + 0.5d	-0.15μA

MAXIMUM FULL SCALE VOLTAGE: -1V.

MAXIMUM OPEN CIRCUIT VOLTAGE: -2V.

OVERLOAD PROTECTION: 300V DC or rms on all ranges.

DIODE TEST: On-scale reading for forward biased silicon diode.

## DC AMPS

RANGE	RESOLUTION	ACCURACY (1 YEAR) ±(%rdg + digits) 18°-28°C	TEMPERATURE COEFFICIENT ±(%rdg + digits)/°C 0°-18°C & 28°-50°C	MAXIMUM VOLTAGE BURDEN
50mA	10 μA	0.25% + 2d	0.05% + 0.3d	0.6V
10 A	10mA	1% + 2d	0.05% + 0.3d	0.3V

OVERLOAD PROTECTION: 50mA input: 0.75A fuse (250V), externally accessible. 10A input: 20A for 15s unfused.

## AC AMPS

RANGE	RESOLUTION	ACCURACY (1 YEAR) 45Hz-1kHz ±(%rdg + digits) 18°-28°C	TEMPERATURE COEFFICIENT ±(%rdg + digits)/°C 0°-18°C & 28°-50°C
50mA	10 μA	1.5% + 5d	0.15% + 0.5d
10 A	10mA	1.5% + 5d	0.15% + 0.5d

OVERLOAD PROTECTION: 50mA input: 0.75A fuse (250V), externally accessible. 10A input: 20A for 15s unfused.

## GENERAL

DISPLAY: 4½-digit LCD, 0.6" height, polarity and range indication, low battery warning.

CONVERSION PERIOD: 400ms (2.5 readings/second).

OVERRANGE INDICATION: 4 least significant digits blanked.

MAXIMUM COMMON MODE VOLTAGE: 500V DC or peak AC.

OPERATING ENVIRONMENT: 0° to 50°C; less than 80% relative humidity up to 35°C; linearly derate 3% RH/°C, 35° to 50°C.

STORAGE ENVIRONMENT: -35° to 60°C, less than 90% relative humidity up to 35°C; linearly derate 3% RH/°C, 35°C to 50°C.

POWER: One 9V alkaline or carbon-zinc battery (NEDA 1604).

BATTERY LIFE: 100 hours typical with alkaline battery; 50 hours typical with carbon-zinc battery.

BATTERY INDICATOR: Display indicates "BAT" when less than 10% of life remains.

DIMENSIONS, WEIGHT: 178mm long × 78mm wide × 42mm thick (7.0" × 3.1" × 1.6"). Net weight 400gm (14.1 oz.).

ACCESSORIES SUPPLIED: Battery, instruction manual, Model 1691 Test Lead Set.

## ACCESSORIES AVAILABLE:

- Model 1301: Temperature Probe
- Model 1304: Soft Carrying Case & Stand
- Model 1306: Heavy Duty Carrying Case
- Model 1359: Spare Parts Kit
- Model 1600A: High Voltage Probe
- Model 1651: 50-Ampere Current Shunt
- Model 1681: Clip-On Test Lead Set
- Model 1682A: RF Probe
- Model 1683: Universal Test Lead Kit
- Model 1685: Clamp-On Current Probe
- Model 1691: General Purpose Test Lead Set

# 132C, 132F/Digital Multimeter

## TRMS + Temperature

- 0.25% basic DC accuracy
- Temperature measurement (Type K TC) to 2000°F/1370°C
- °C or °F versions



The Model 132 combines the rugged field service capabilities of Keithley's basic handheld DMMs with the most often required additional measurement capabilities: TRMS AC and temperature. Available in both a °F version (132F) and a °C version (132C), the 132 has complete DC voltage ranges from 200mV to 1000V with 0.25% accuracy, current ranges from 2mA to 2A and resistance ranges from 200Ω to 20MΩ. The 132C measures temperature from -20°C to 1370°C, the 132F from 0°F to 2000°F using optional Type K thermocouple sensors or probes.

### Type K thermocouple

There are several advantages to employing a Type K (NiCr-NiAl) thermocouple input for temperature measurement:

- Wide use throughout industry
- Broad selection of probes and sensors available
- Low cost, versatile, durable

### Standard TC connector

In order to fully realize all the advantages of a Type K thermocouple,

the 132 provides a standard TC connector for sensor termination. This effectively eliminates stabilization time required with banana jack inputs for immediate, accurate readings. Cold junction electronic circuitry automatically compensates for ambient temperature changes. And the TC input is protected from overloads up to 300V.

### TRMS

TRMS AC response is provided to make precision measurements of non-sinusoidal waveforms that averaging cannot handle. Examples include square waves, pulse trains and SCR waveforms. The Model 132's AC bandwidth is designed to capture the necessary spectral components for minimal error on 50Hz and 60Hz waveforms, where most measurements are made.

### AC coupled

The Model 132 blocks out any DC signal combined with the AC information that you are really after. This allows you to measure the AC and DC components of a signal separately, as when measuring AC ripple on a DC voltage, for example.

# Digital Multimeter/132C, 132F

TRMS + Temperature

## DC VOLTS

RANGE	RESOLUTION	ACCURACY (1 YEAR) ±(%rdg + digits) 18°-28°C
200mV	100 μV	±(0.25% + 1d)
2 V	1mV	
20 V	10mV	
200 V	100mV	
1000 V	1 V	

**MAXIMUM ALLOWABLE INPUT:** 1000V DC or peak AC non-switched, 750V peak switched.

**INPUT RESISTANCE:** 10MΩ.

**NORMAL MODE REJECTION RATIO:** Greater than 46dB at 50Hz, 60Hz.

**COMMON MODE REJECTION RATIO:** Greater than 100dB at DC, 50Hz and 60Hz (1kΩ unbalance).

## TRMS AC VOLTS

RANGE	RESOLUTION	ACCURACY (1 YEAR) ±(%rdg + digits) 18°-28°C	FREQUENCY RANGE
200mV	100 μV	±(1% + 9d)	45Hz-500Hz
2 V	1mV		
20 V	10mV		
200 V	100mV		
750 V	1 V		

**MAXIMUM ALLOWABLE INPUT:** 1000V peak non-switched, 750V peak switched; continuous except 200mV range: 15s max above 300V.

**INPUT IMPEDANCE:** 10MΩ shunted by less than 100pF.

**RESPONSE:** True root mean square; AC coupled.

**CREST FACTOR:** Up to 3:1 allowable. Less than 2% additional error, 50Hz or 60Hz rectangular pulse train with crest factor of 3:1.

## DC AMPS

RANGE	RESOLUTION	ACCURACY (1 YEAR) ±(%rdg + digits) 18°-28°C	MAXIMUM FULL SCALE VOLTAGE BURDEN
2mA	1 μA	±(0.75% + 1d)	0.25V
20mA	10 μA	±(0.75% + 1d)	0.25V
200mA	100 μA	±(1% + 1d)	0.25V
2000mA	1mA	±(2% + 1d)	0.7 V

**OVERLOAD PROTECTION:** 2A fuse (250V), externally accessible.

## TRMS AC AMPS

RANGE	RESOLUTION	ACCURACY (1 YEAR) ±(%rdg + digits) 18°-28°C (45Hz-500Hz)	MAXIMUM FULL SCALE VOLTAGE BURDEN
2mA	1 μA	±(2% + 9d)	0.25V
20mA	10 μA	±(2% + 9d)	0.25V
200mA	100 μA	±(2% + 9d)	0.25V
2000mA	1mA	±(3% + 9d)	0.7 V

**OVERLOAD PROTECTION:** 2A fuse (250V), externally accessible.

**RESPONSE:** True root mean square, AC coupled.

**CREST FACTOR:** Less than 1.5% additional error, 50Hz or 60Hz rectangular pulse train with crest factor of 3:1 at 40% of full scale.

## OHMS

RANGE	RESOLUTION	ACCURACY (1 YEAR) ±(%rdg + digits) 18°-28°C	FULL SCALE VOLTAGE
200 Ω	100mΩ	±(0.5% + 4d)	< 0.5V
2 kΩ	1 Ω	±(0.2% + 1d)	< 0.7V
20 kΩ	10 Ω	±(0.2% + 1d)	> 0.7V
200 kΩ	100 Ω	±(0.2% + 1d)	> 0.7V
20MΩ	10 kΩ	±(2% + 1d)	> 0.7V

**MAXIMUM OPEN CIRCUIT VOLTAGE:** 1.5V.

**MAXIMUM ALLOWABLE INPUT:** 300V DC or rms.

## TEMPERATURE

MODEL	RANGE	RESOLUTION	ACCURACY (1 YEAR) 18°-28°C
132C	-20°C to 1370°C	1°C	±(3° + 1d) up to 150°C ±3% of reading over 150°C Chart correctable to ±1.5% of reading over 350°C
132F	0°F to 2000°F	1°F	±(5° + 2 digits) up to 225°F ±3% of reading over 225°F Chart correctable to ±1.5% of reading over 600°F

Accuracy includes NBS conformity, calibration stability, zero and reference junction, but not thermocouple errors.

**SENSOR:** Type K (NiCr-NiAl) (not included).

**INPUT CONNECTIONS:** Miniature TC connector.

**OVERLOAD PROTECTION:** 150V continuous, 300V momentary (10s).

## GENERAL

**DISPLAY:** 0.6" LCD digits with decimal and polarity indications, low battery warning.

**OVERRANGE INDICATION:** 3 least significant digits blanked.

**MAXIMUM COMMON MODE VOLTAGE:** 500V peak.

**OPERATING ENVIRONMENT:** 0° to 50°C; less than 80% relative humidity up to 35°C. Linearly derate 3% RH/°C, 35°C to 50°C.

**STORAGE ENVIRONMENT:** -35° to 60°C; less than 90% relative humidity up to 35°C. Linearly derate 3% RH/°C, 35°C to 60°C.

**TEMPERATURE COEFFICIENT:** From 18° to 28°C: Included in accuracy specifications; from 0° to 18°C and 28° to 50°: Less than 0.1 × applicable accuracy specification per °C.

**POWER:** 9V alkaline or carbon-zinc battery (NEDA 1604).

**BATTERY LIFE:** 75 hours typical with carbon-zinc cells, 150 hours typical with alkaline cells.

**BATTERY INDICATOR:** Display indicates BAT when less than 10% of life remains.

**DIMENSIONS, WEIGHT:** 178mm long × 78mm wide × 42mm thick (7.0" × 3.1" × 1.6"). Net weight 370gm (13 oz.).

**ACCESSORIES SUPPLIED:** Battery, instruction manual, Model 1691 General Purpose Test Lead Set.

## ACCESSORIES AVAILABLE:

- Model 1304: Soft Carrying Case & Stand
- Model 1306: Heavy Duty Carrying Case
- Model 1600A: High Voltage Probe
- Model 1651: 50-Ampere Current Shunt
- Model 1681: Clip-On Test Lead Set
- Model 1682A: RF Probe
- Model 1683: Universal Test Lead Kit
- Model 1685: Clamp-On AC Current Probe
- Model 1691: General Purpose Test Lead Set
- Model 8700: Carrying Case with Belt Clip and Holster
- Model 8711A: Thermocouple Kit
- Model 8712: Thermocouple Sensor
- Model 8713: General Purpose Probe
- Model 8714A: Penetration Probe with Coiled Cable
- Model 8715: Surface Probe
- Model 8716: Air/Gas Probe
- Model 8717: Hypodermic Probe

# 169/Digital Multimeter

3½-Digit LCD Portable/Bench

- Display annunciators indicate range and function
- 2000 hour battery life
- Line power option

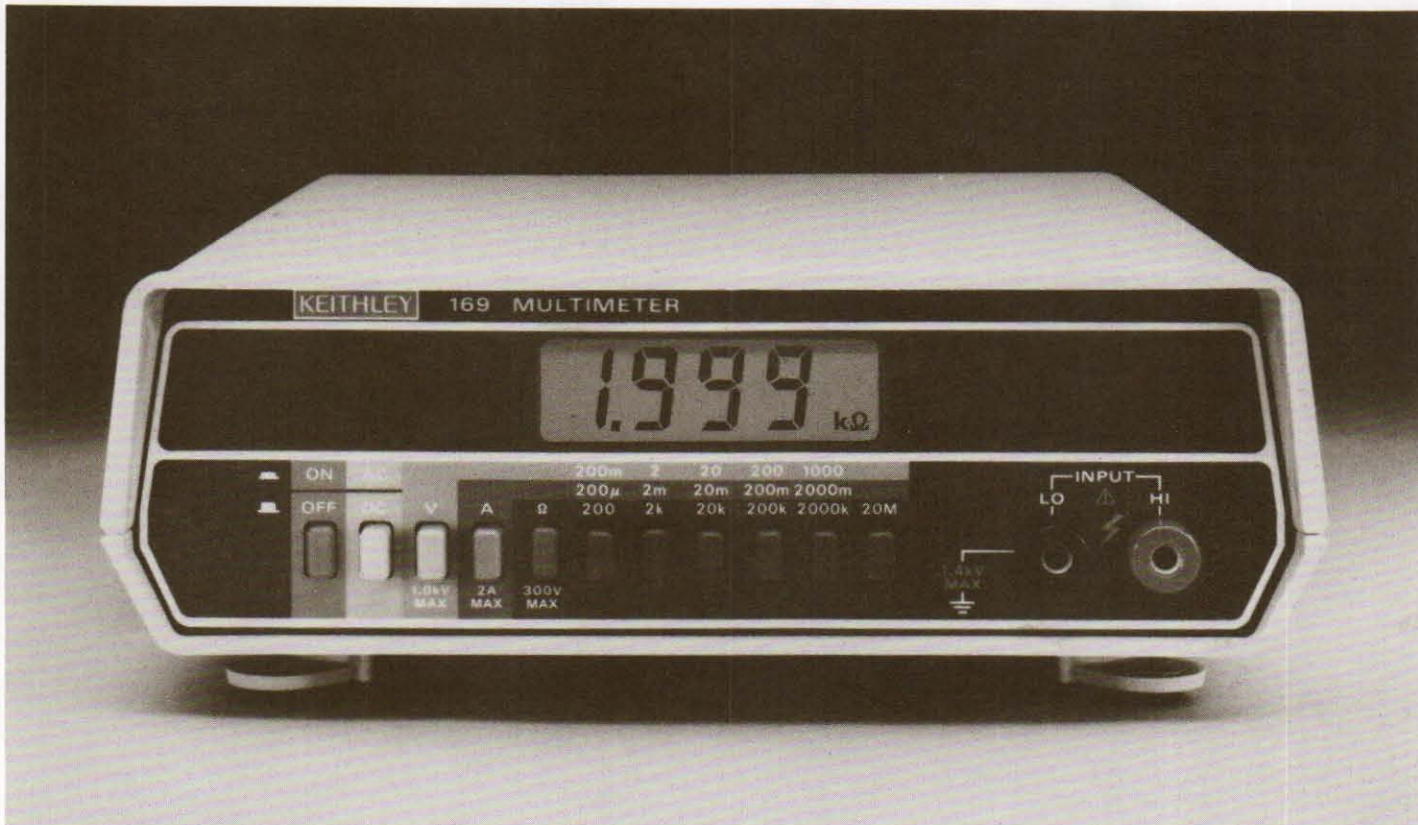

The Keithley 169 provides full capability for many general purpose applications. It has five functions: DC volts, DC amps, AC volts, AC amps and ohms. The full bench-sized case, molded from impact-resistant flame-retardant plastic, is the same case used on more sophisticated Keithley DMMs. Input protection prevents damage on all functions. Voltage ranges are protected to 1400V peak, ohms is protected to 300V rms, and current ranges are protected by an externally accessible 2A (250V) fuse.

#### Easy to use

The 169 has both range and function annunciators. Pushbutton switches are color-coded to the front panel. Two input jacks and auto polarity mean no lead changing. The decimal point is switched automatically when range is changed. A sixteen-position tilt bail/handle allows the meter to be positioned for easiest reading and convenient use. Zeroing is automatic. Low battery condition is automatically indicated.

By using alkaline batteries, 2000 hours (1 year) of operation can be expected. Thus, battery life can be the same as the calibration cycle. Only 1 adjustment is required. MTBF is 20,000 hours, so most units

will never need repair. If they do, all components are on one easily accessible PC board.

#### Wide range

Sensitive down to 100 $\mu$ V, 100nA and 100m $\Omega$ , the Model 169 spans the most used ranges up to 1000V, 2000mA and 20M $\Omega$ . Out-of-range inputs are indicated by a leading "1" with the rest of the digits blanked. Improper range-function combinations are indicated by contradicting function/range annunciators appearing simultaneously.

#### Line power option

A line power option, Model 1766 can be installed in place of the batteries. This option, which includes a fully isolated power supply and 3-wire grounded line cord, operates over the entire voltage range of 105-250V AC, 50-60Hz, without switching. The Model 1766 is field installable. When ordering the Model 169 with the 1766 installed, specify Model 169/1766.

#### Schools and colleges

The Model 169's ease of use and bench package make it an ideal unit for use in school labs. Its rugged mechanical and electrical design allow it to withstand most student use.



# Digital Multimeter/169

3½-Digit LCD Portable/Bench

## DC VOLTS

RANGE	RESOLUTION	ACCURACY (1 YEAR) 18°-28°C
200mV	100 µV	±(0.25% of reading + 1 digit)
2 V	1mV	
20 V	10mV	
200 V	100mV	
1000 V	1 V	

MAXIMUM ALLOWABLE INPUT: 1000V DC, 1400V peak AC.

INPUT RESISTANCE: 10MΩ.

NORMAL MODE REJECTION RATIO: Greater than 50dB at 50Hz, 60Hz.

COMMON MODE REJECTION RATIO: Greater than 100dB at DC, 50Hz and 60Hz (1kΩ unbalance, 500V).

## AC VOLTS

RANGE	RESOLUTION	ACCURACY (1 YEAR) 18°-28°C	
		45Hz-1kHz	1kHz-5kHz
200mV	100 µV	±(0.75% rdg + 5d)	±(5% rdg + 7d)
2 V	1mV		
20 V	10mV		
200 V	100mV		
1000 V	1 V		

MAXIMUM ALLOWABLE INPUT: 1000V rms, 1400V peak, 10°V•Hz, continuous except 200mV range: 350V continuous, 15s maximum above 350V.

RESPONSE: Average responding, calibrated in rms of a sine wave.

INPUT IMPEDANCE: 10MΩ shunted by less than 100pF.

## DC AMPS

RANGE	RESOLUTION	ACCURACY (1 YEAR) 18°-28°C	MAXIMUM VOLTAGE BURDEN
200 µA	100 nA	±(0.75% rdg + 1d)	0.25V
2mA	1 µA		0.25V
20mA	10 µA		0.25V
200mA	100 µA		0.3 V
2000mA	1mA		0.7 V

OVERLOAD PROTECTION: 2A fuse (250V), externally accessible.

## AC AMPS

RANGE	RESOLUTION	ACCURACY (1 YEAR)	MAXIMUM VOLTAGE BURDEN
		18°-28°C (45Hz-1kHz)	
200 µA	100 nA	±(1.5% rdg + 1d)	0.25V
2mA	1 µA		0.25V
20mA	10 µA		0.25V
200mA	100 µA		0.3 V
2000mA	1mA		0.7 V

OVERLOAD PROTECTION: 2A fuse (250V), externally accessible.

## OHMS

RANGE	RESOLUTION	ACCURACY (1 YEAR) 18°-28°C	FULL SCALE VOLTAGE
200 Ω	100mΩ	±(0.3% rdg + 3d)	< 0.5V
2 kΩ	1 Ω	±(0.2% rdg + 1d)	< 0.5V
20 kΩ	10 Ω	±(0.2% rdg + 1d)	> 0.7V
200 kΩ	100 Ω	±(0.2% rdg + 1d)	> 0.7V
2000 kΩ	1 kΩ	±(0.2% rdg + 1d)	> 0.7V
20MΩ	10 kΩ	±(2.0% rdg + 1d)	> 0.7V

MAXIMUM OPEN CIRCUIT VOLTAGE: 1.5V except 200Ω range: 3.5V.

MAXIMUM ALLOWABLE INPUT: 300V DC or rms.

## GENERAL

DISPLAY: 3½-digit LCD, 0.6" numeral height, with polarity, range and function annunciators.

OVERRANGE INDICATION: 3 least significant digits blanked.

MAXIMUM COMMON MODE VOLTAGE: 1400V peak.

OPERATING ENVIRONMENT: 0° to 50°C; less than 80% RH up to 35°C, less than 70% RH from 35° to 60°C.

STORAGE ENVIRONMENT: -35° to 60°C.

TEMPERATURE COEFFICIENT (0°-18°C & 28°-50°C): Less than 0.1 × applicable accuracy specification per °C.

POWER: Six 1.5V "C" cells. Optional line power (Model 1766) 105-250V, 50-60Hz.

BATTERY LIFE: 1000 hours typical with C-Zn cells; 2000 hours with alkaline cells.

BATTERY INDICATOR: Display indicates "BAT" when less than 5% of life remains.

DIMENSIONS, WEIGHT: 85mm high × 235mm wide × 275mm deep (3½" × 9¼" × 10¾"). Net weight 1.4kg (3 lbs.).

## ACCESSORIES AVAILABLE:

Model 1010: Single Rack Mounting Kit

Model 1017: Dual Rack Mounting Kit

Model 1301: Temperature Probe

Model 1600A: High Voltage Probe

Model 1651: 50A Current Shunt

Model 1681: Clip-On Test Lead Set

Model 1682A: RF Probe

Model 1683: Universal Test Lead Kit

Model 1684: Hard Shell Carrying Case

Model 1685: Clamp-On AC Current Probe

Model 1691: General Purpose Test Leads

Model 1699: Spare Parts Kit

Model 1766: Line Power Option

Model 1768: Battery Pack (for converting 169/1766 to battery power)

# 179A/Digital Multimeter

4½-Digit TRMS Bench

- TRMS AC
- IEEE-488 option
- 20 amps
- LED display
- Hi-Lo ohms

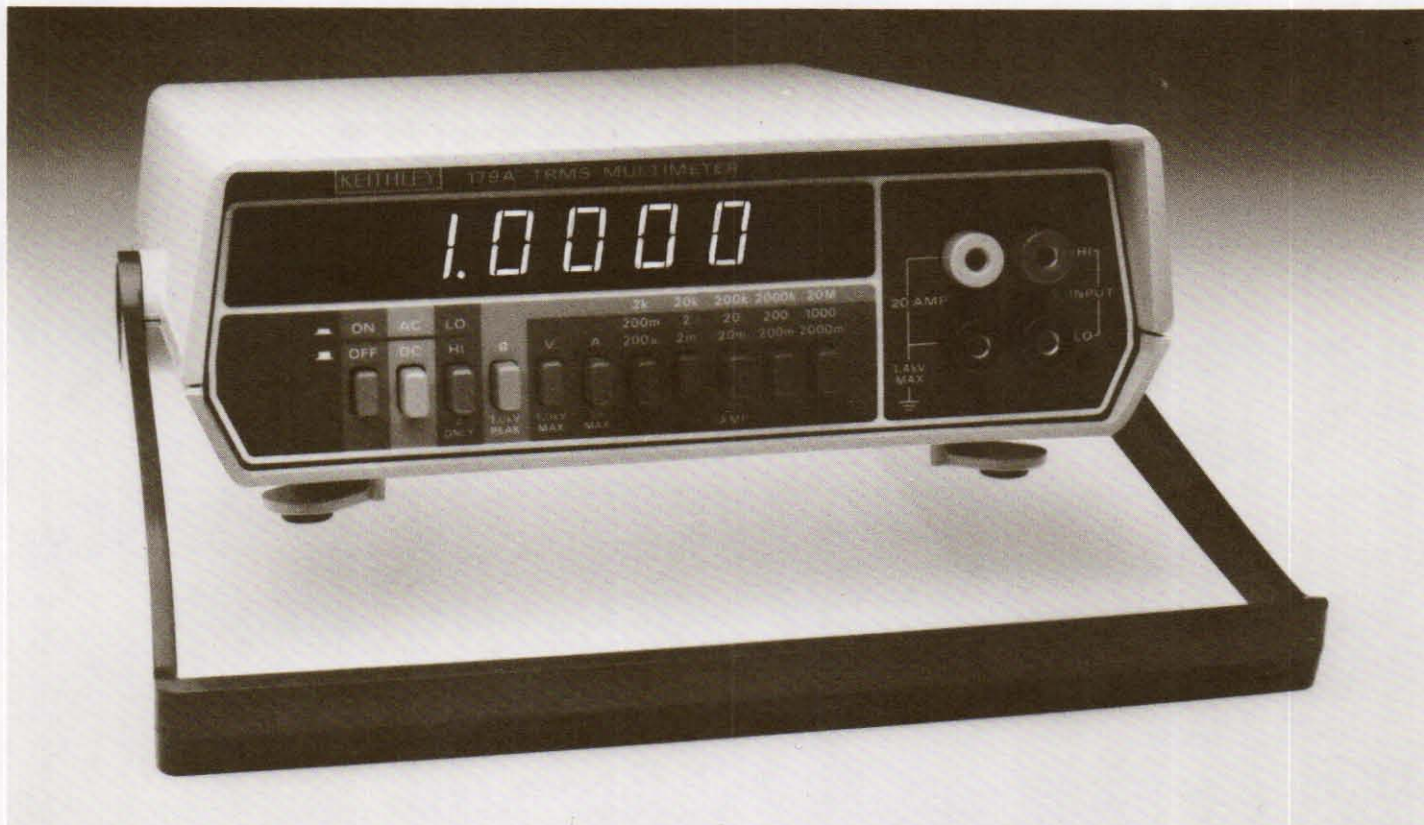

The Keithley Model 179A is a precision 4½-digit multimeter with expanded range of current measuring capability. This extra range uses separate input terminals and allows continuous measurement of up to 15A AC/DC or periodic measurements up to 20A AC/DC. The 179A is needed for many applications beyond the 2A range of most DMMs, such as measurement of the 5V, 10A logic supply of a computer mainframe or peripheral, measurement of the output of a current transformer, or to monitor battery charging.

## TRMS

TRMS AC measurement capability gives waveform insensitive measurement accuracy to applications such as solid-state regulator design, measurement of power transformer input currents and capacitor ripple currents. TRMS AC is especially necessary since as little as 2% distortion can seriously degrade the accuracy of an average-responding meter.

## HI-LO ohms

In the HI mode, enough voltage can be applied to semiconductors to turn them on for a test. LO can be used for in-circuit measurements without turning on semiconductor junctions. Full-scale compliance voltage is 2V on HI, 200mV on LO.

## IEEE-488 Interface

The 179A is part of Keithley's 488 Line of low-cost interfaceable DMMs. A single plug-in PC board can be installed when ordered or easily field-installed later to enable communication of measured data to monitoring devices such as desk-top computers or printers at affordable prices.

### System flexibility

The Model 1793 IEEE-488 Interface offers all the operational output variations you'll require. For example, in the ADDRESSABLE trigger mode, the controller initiates the measurement and receives the output reading 400ms later. In the ADDRESSABLE non-trigger mode, the instrument will output the reading immediately. Either mode may be commanded under software control using separate addresses.

In the TALK ONLY mode, the instrument will output readings to a printer at a selectable rate from 2.5 readings per second to one reading per hour. No controller is required in this mode. The Model 1793 is field installable and supplied with a new top cover for the instrument. When ordering Model 179A with 1793 option installed, specify Model 179A/1793.

# Digital Multimeter/179A

4<sup>1</sup>/<sub>2</sub>-Digit TRMS Bench

## DC VOLTS

RANGE	RESOLUTION	ACCURACY (1 YEAR) 18°-28°C		MAXIMUM ALLOWABLE INPUT
		±(%rdg+digits)		
200mV	10 μV	0.04%+3d		1200V <sup>1</sup>
2 V	100 μV	0.04%+1d		1200V <sup>1</sup>
20 V	1mV	0.04%+1d		1200V <sup>2</sup>
200 V	10mV	0.04%+1d		1200V <sup>2</sup>
1200 V	100mV	0.04%+1d		1200V <sup>2</sup>

<sup>1</sup>For 10 seconds. <sup>2</sup>Continuous.

TEMPERATURE COEFFICIENT (0°-18°C & 28°-55°C): ±(0.006%+0.2d)  
/°C except ±(0.006%+0.4d)/°C on 200mV range.

INPUT RESISTANCE: 10MΩ±0.1%.

NORMAL MODE REJECTION RATIO: Greater than 60dB at 50Hz and 60Hz.

COMMON MODE REJECTION RATIO (1kΩ unbalance): Greater than 120dB at DC, 50Hz and 60Hz.

SETTLING TIME: 1 second to within 1 digit of final reading.

## TRMS AC VOLTS

RANGE	RESOLUTION	ACCURACY (1 YEAR) (above 2000 counts)		TEMPERATURE COEFFICIENT	
		18°-28°C; 100Hz-10kHz		0°-18°C & 28°-55°C	10kHz-20kHz
		±(%rdg+digits)		±(%rdg+digits)/°C	
200mV	10 μV	0.7%+15d		0.07%+2d	0.15%+3d
2 V	100 μV	0.6%+15d		0.07%+2d	0.15%+3d
20 V	1mV	0.5%+15d		0.05%+2d	0.05%+2d
200 V	10mV	0.5%+15d		0.05%+2d	0.05%+2d
1000 V	100mV	0.5%+15d		0.05%+2d	0.05%+2d

### EXTENDED FREQUENCY ACCURACY:

(45Hz-100Hz): ±(0.7%+15d).

(10kHz-20kHz): ±(0.8%+15d) on 20V and higher ranges;

±(1.5%+15d) on 2V range;

±(2%+15d) on 200mV range.

RESPONSE: True root mean square.

CREST FACTOR (ratio of peak value to rms value): 3:1.

INPUT IMPEDANCE: 1MΩ shunted by less than 75pF.

MAXIMUM ALLOWABLE INPUT VOLTAGE: 1000V rms, 1400V peak,  
10°V•Hz maximum.

COMMON MODE REJECTION RATIO (1kΩ unbalance): 60dB at DC,  
50Hz and 60Hz.

SETTLING TIME: 2 seconds to within 15 digits of final reading.

## DC AND TRMS AC AMPS

RANGE	RESOLUTION	ACCURACY (1 YEAR) 18°-28°C		MAXIMUM VOLTAGE	SHUNT RESISTANCE
		±(%rdg+digits)			
		DC	AC 45Hz-10kHz (above 2000 cts)	BURDEN	
200 μA	10 nA	0.2%+2d	1%+15d	0.2 V	1 kΩ
2mA	100 nA	0.2%+2d	1%+15d	0.2 V	100 Ω
20mA	1 μA	0.2%+2d	1%+15d	0.2 V	10 Ω
200mA	10 μA	0.2%+2d	1%+15d	0.25V	1 Ω
2000mA	100 μA	0.2%+2d	1%+15d	0.6 V	100mΩ
20 A	1mA	0.5%+2d <sup>1*</sup>		0.5 V	10mΩ

<sup>1</sup>Add 0.1% rdg. above 15A for self-heating.

<sup>2</sup>±1kHz max.

MAXIMUM INPUT: 2A, 250V DC or rms (fuse protected) except for 20A  
range: 15A continuous, 20A for 1 minute (unfused).

TEMPERATURE COEFFICIENT (0°-18°C & 28°-55°C):

DC ±(0.01%+0.2d)/°C.

AC ±(0.07%+2d)/°C.

CREST FACTOR (ratio of peak value to rms value): 3:1.

SETTLING TIME: DC: 1 second to within 1 digit of final reading. AC: 2  
seconds to within 15 digits of final reading.

## OHMS

RANGE	RESOLUTION	ACCURACY (1 YEAR) 18°-28°C		MAXIMUM VOLTAGE ACROSS UNKNOWN ON RANGE		TEMPERATURE COEFFICIENT 0°-18°C & 28°-55°C		NOMINAL APPLIED CURRENT	
		±(%rdg+digits)		HI Ω	LO Ω	HI Ω	LO Ω	HI Ω	LO Ω
2 kΩ	100mΩ	0.15%+15d		2V	0.2V	0.003%+0.2d	0.02%+2d	100 μA	100 μA
20 kΩ	1 Ω	0.04%+1d 0.15%+15d		2V	0.2V	0.003%+0.2d	0.02%+2d	10 μA	10 μA
200 kΩ	10 Ω	0.04%+1d 0.15%+15d		2V	0.2V	0.003%+0.2d	0.02%+2d	1 μA	1 μA
2000 kΩ	100 Ω	0.04%+1d 0.15%+15d		2V	0.2V	0.003%+0.2d	0.03%+2d	1 μA	0.1μA
20MΩ	1 kΩ	0.10%+1d		2V	2V	0.02%+0.2d		0.1μA	

MAXIMUM ALLOWABLE INPUT: 1kV DC or peak AC for 10 seconds,  
450V rms continuous.

MAXIMUM OPEN CIRCUIT VOLTAGE: 5V.

SETTLING TIME: 1 second to within 1 digit of final reading except 2 sec-  
onds on 20MΩ range. Ohms settling time is specified for on-scale  
readings. 20MΩ is 5s for overrange to on-scale readings.

## GENERAL

DISPLAY: Five 0.5" LED digits, appropriate decimal position and polarity  
indication.

CONVERSION PERIOD: 400ms.

OVERRANGE INDICATION: Display blinks all zeroes.

MAXIMUM COMMON MODE VOLTAGE: 1400V peak.

ENVIRONMENT: Operating: 0°-55°C, 0% to 80% relative humidity up  
to 35°C. Storage: -25°C to +65°C.

POWER: 105-125V (switch selected), 90-110V available. 50-60 Hz, 5.5W.  
Optional 6-hour battery pack. Model 1788 is field installable. When  
ordering 179A with 1788 installed, specify Model 179A/1788. Note:  
1788 cannot be installed in units with 1792 or 1793 options.

DIMENSIONS, WEIGHT: 85mm high × 235mm wide × 275mm deep  
(3<sup>1</sup>/<sub>2</sub>" × 9<sup>1</sup>/<sub>4</sub>" × 10<sup>3</sup>/<sub>4</sub>"). Net weight 1.8kg (4 lbs.).

ACCESSORIES SUPPLIED: Instruction Manual and Model 1691 Test  
Leads.

## ACCESSORIES AVAILABLE:

Model 1010: Single Rack Mounting Kit

Model 1017: Dual Rack Mounting Kit

Model 1301: Temperature Probe

Model 1600A: High Voltage Probe (40kV)

Model 1651: 50-Ampere Current Shunt

Model 1681: Clip-On Test Lead Set

Model 1682A: RF Probe

Model 1683: Universal Test Lead Kit

Model 1684: Hard Shell Carrying Case

Model 1685: Clamp-On AC Probe

Model 1691: General Purpose Test Lead Set

Model 1788: Rechargeable Battery Pack

Model 1792: Isolated BCD Output

Model 1793: Isolated IEEE-488 Output

Model 7008-3: IEEE-488 Cable (3 ft.)

Model 7008-6: IEEE-488 Cable (6 ft.)

# 177/Digital Multimeter

4½-Digit with 1μV/1mΩ/1nA Sensitivity

- Analog and BCD or IEEE-488 outputs
- TRMS AC
- 1μV, 1mΩ, 1nA sensitivity



Keithley's Model 177 Microvolt DMM features extended capabilities for the most sensitive bench measurements. The Model 177's 1μV sensitivity lets you measure a multitude of low-level DC signals, including transducer outputs at practical limits of detectability. And its 4½-digit precision lets you resolve these even in the presence of large steady-state signals.

#### Analog output

The Model 177 has a rear panel output where 1V DC corresponds to 10,000 counts. The Model 177 serves as an amplifier (for microvolt signals), an attenuator (for kilovolt signals), or as a converter to DCV (for AC, current and resistance signals).

#### 1mΩ

The Model 177's 1mΩ resolution and 4½-digit accuracy bring economy and ease to low-resistance measurement tasks. Measurements are simple with the 2-terminal input and front-panel control for lead resistance compensation.

#### 1nA

The Model 177's 1nA DC resolution is a decade greater sensitivity than found in most DMMs.

#### TRMS AC

The Model 177's TRMS response lets you measure real-life waveforms. Specified accuracy is retained for sinusoids, distorted sinusoids and non-sinusoid waveforms alike. Crest factor is 3:1 at full scale (19999 counts), increasing downscale. Frequency response spans the standard audio range from 45Hz to 20kHz.

#### Diode test

Check semiconductor junctions using the 2kΩ range where the applied current is 1mA ± 1% and the forward voltage drop is displayed dir-

ectly (to 1.9999 volts). Reverse bias registers as overrange (5 volts open circuit).

#### Battery option

The Model 1788 Battery Pack is for those who need isolation from line, whether for field use or for minimum coupling in critical measurements. This rechargeable lead-acid pack can be purchased with the Model 177 or later for simple field installation.

#### IEEE-488 Interface

The 177 is part of Keithley's 488 Line of low-cost interfaceable DMMs. A single plug-in PC board can be installed when ordered or easily field-installed later to enable communication of measured data to monitoring devices such as desk-top computers or printers at affordable prices.

#### System flexibility.

The Model 1793 IEEE-488 Interface offers all the operational output variations you'll require. For example, in the ADDRESSABLE trigger mode, the controller initiates the measurement and receives the output reading 400ms later. In the ADDRESSABLE non-trigger mode, the instrument will output the reading immediately. Either mode may be commanded under software control using separate addresses.

In the TALK ONLY mode, the instrument will output readings to a printer at a selectable rate from 2.5 readings per second to one reading per hour. No controller is required in this mode. The Model 1793 is field installable and supplied with a new top cover for the instrument. When ordering Model 177 with 1793 option installed, specify Model 177/1793.

# Digital Multimeter/177

4<sup>1</sup>/<sub>2</sub>-Digit with 1 $\mu$ V/1m $\Omega$ /1nA Sensitivity

## DC VOLTS

RANGE	RESOLUTION	ACCURACY (1 YEAR)		MAXIMUM ALLOWABLE INPUT
		18°-28°C ±(% rdg + digits)		
20mV*	1 $\mu$ V	0.4 % + 2		1200V momentary
200mV*	10 $\mu$ V	0.4 % + 1		1200V momentary
2 V	100 $\mu$ V	0.3 % + 1		1200V momentary
20 V	1mV	0.3 % + 1		1200V
200 V	10mV	0.3 % + 1		1200V
1200 V	100mV	0.35 % + 1		1200V

\*Front panel zero

TEMPERATURE COEFFICIENT (0°-18°C & 28°-55°C):  $\pm(0.005\% + 0.1 \text{ digit})/^\circ\text{C}$  except  $\pm(0.005\% + 0.6 \text{ digit})/^\circ\text{C}$  on 20mV range.

INPUT RESISTANCE: 10M $\Omega$   $\pm$ 0.5%.

NMRR: Greater than 80dB on 20mV range at 50Hz and 60Hz; greater than 60dB on all other ranges.

CMRR (1k $\Omega$  unbalance): Greater than 120dB at DC, 50Hz and 60Hz.

## DC & TRMS AC AMPS

RANGE	RESOLUTION	DC*	ACCURACY (1 YEAR)		MAXIMUM VOLTAGE BURDEN
			18°-28°C ±(% rdg + digits)		
			AC 45Hz-10kHz (above 2000 counts)		
20 $\mu$ A	1nA	0.2% + 2	—		0.02V
200 $\mu$ A	10nA	0.2% + 1	0.8% + 15		0.2 V
2mA	100nA	0.2% + 1	0.8% + 15		0.2 V
20mA	1 $\mu$ A	0.2% + 1	0.8% + 15		0.2 V
200mA	10 $\mu$ A	0.2% + 1	0.8% + 15		0.25V
2000mA	100 $\mu$ A	0.2% + 1	0.8% + 15		0.6 V

\*Front panel zero

MAXIMUM INPUT: 2A, 250V DC or rms (fuse protected).

TEMPERATURE COEFFICIENT (0°-18°C & 28°-55°C): DC:  $\pm(0.01\% + 0.2 \text{ digit})/^\circ\text{C}$  except  $\pm(0.01\% + 0.6 \text{ digit})/^\circ\text{C}$  on 20 $\mu$ A range. AC:  $\pm(0.07\% + 2 \text{ digits})/^\circ\text{C}$ .

CREST FACTOR: 3.

## GENERAL

DISPLAY: Five 0.5" LED digits, appropriate decimal position and polarity indication.

CONVERSION PERIOD: 400ms

OVERRANGE INDICATION: Display blinks all zeros above 19999 counts.

MAXIMUM COMMON MODE VOLTAGE: 1400V peak.

ANALOG OUTPUT:

Output Voltage: 1V = 10,000 counts.

Output Resistance: 5000 $\Omega$ .

CONNECTORS: Input: Binding posts. Output: Banana jacks.

ENVIRONMENT: Operating: 0°C to 55°C, 0 to 80% relative humidity up to 40°C. Storage: -25° to 65°C.

POWER: 105-125V or 210-250V (switch selected), 90-110V available. 50-60Hz, 8W. Optional 6-hour battery pack, Model 1788.

DIMENSIONS, WEIGHT: 85mm high  $\times$  235mm wide  $\times$  275mm deep (3<sup>1</sup>/<sub>2</sub>"  $\times$  9<sup>1</sup>/<sub>4</sub>"  $\times$  10<sup>3</sup>/<sub>4</sub>"). Net weight, 1.7kg (4 lbs.).

ACCESSORY SUPPLIED: Instruction manual.

## TRMS AC VOLTS

RANGE	RESOLUTION	ACCURACY (1 YEAR)	
		18°-28°C; 100Hz-10kHz ±(% rdg + digits)	
200mV	10 $\mu$ V	0.5% + 15	
2 V	100 $\mu$ V	0.5% + 15	
20 V	1mV	0.5% + 15	
200 V	10mV	0.5% + 15	
1000 V	100mV	0.5% + 15	

EXTENDED FREQUENCY ACCURACY (45Hz-20kHz):  $\pm(0.7\% + 15d)$ .  
TEMPERATURE COEFFICIENT (0°-18°C & 28°-55°C, 45Hz-20kHz):  $\pm(0.05\% + 2 \text{ digits})/^\circ\text{C}$ .

RESPONSE: True root mean square.

CREST FACTOR: 3.

INPUT IMPEDANCE: 1M $\Omega$   $\pm$ 1% shunted by less than 75pF.

MAXIMUM ALLOWABLE INPUT: 1000V rms, 1400V peak, 10<sup>7</sup>V $\cdot$ Hz.

CMRR (1k $\Omega$  unbalance): 60dB at DC, 50Hz and 60Hz.

## OHMS

RANGE	RESOLUTION	ACCURACY (1 YR.)		TEMPERATURE COEFFICIENT 0°-18°C & 28°-55°C ±(% rdg + digits)/°C	NOMINAL APPLIED CURRENT
		18°-28°C ±(% rdg + digits)			
20 $\Omega$ *	1m $\Omega$	0.05% + 3		0.004% + 0.6	1 mA
200 $\Omega$ *	10m $\Omega$	0.05% + 2		0.004% + 0.2	1 mA
2 k $\Omega$	100m $\Omega$	0.04% + 1		0.004% + 0.2	1 mA
20 k $\Omega$	1 $\Omega$	0.04% + 1		0.004% + 0.2	100 $\mu$ A
200 k $\Omega$	10 $\Omega$	0.04% + 1		0.004% + 0.2	10 $\mu$ A
2000 k $\Omega$	100 $\Omega$	0.04% + 1		0.005% + 0.2	1 $\mu$ A
20M $\Omega$	1 k $\Omega$	0.10% + 1		0.02 % + 0.2	0.1 $\mu$ A

\*Front panel zero

MAXIMUM ALLOWABLE INPUT: 350V peak.

OPEN-CIRCUIT VOLTAGE: 5V.

## ACCESSORIES AVAILABLE:

- Model 1010: Single Rack Mounting Kit
- Model 1017: Dual Rack Mounting Kit
- Model 1301: Temperature Probe
- Model 1600A: High Voltage Probe (40kV)
- Model 1641: Kelvin Test Leads
- Model 1651: 50-Ampere Current Shunt
- Model 1681: Clip-On Test Lead Set
- Model 1682A: RF Probe
- Model 1683: Universal Test Lead Kit
- Model 1684: Hard Shell Carrying Case
- Model 1685: Clamp-On AC Probe
- Model 1691: General Purpose Test Lead Set
- Model 1779: Spare Parts Kit
- Model 1788: Rechargeable Battery Pack
- Model 1792: Isolated BCD Output
- Model 1793: Isolated IEEE-488 Output

# 191/Digital Multimeter

5½-Digit Bench

- Pushbutton null
- Automatic 2/4-terminal ohms
- Averaging and TRMS AC volts options



The Keithley 191 is a 5½-digit,  $\pm 200,000$  count, manual ranging bench DMM with DCV and ohms ranges standard. It is capable of 0.0005% resolution and  $1\mu\text{V}$  and  $1\text{m}\Omega$  sensitivity.

Unique in its use of a microprocessor to replace expensive analog circuitry, the 191 delivers unsurpassed accuracy from  $1\mu\text{V}$  to 1200V on five ranges. This DMM measures over a 200,000:1 span with no need to change ranges.

#### $\mu$ Processor design

The 6802-based design allows many analog functions to be done digitally, resulting in fewer parts and higher reliability. Combining both charge balance and single-slope A/D conversion techniques, the 191 automatically zeros and calibrates itself twice a second. At the same time, the 191 offers high conversion and settling speeds. Depending on the function, the 191 converts as fast as 4 times a second, while settling time is 0.5 second on DC voltage ranges.

#### No-noise readings

The microprocessor facilitates digital filtering. On the 200mV and 200 $\Omega$  ranges, the 191's non-linear digital filter eliminates noise by displaying a moving average of eight readings. If it senses an input change of greater than 8 digits, however, the new conversion is displayed. On higher ranges, the threshold and the number of conver-

sions in the average are reduced.

#### Pushbutton null

A front panel pushbutton nulls any on-scale reading. It permits instant nulling of external input offsets. It allows the user to automatically make arithmetic corrections by setting the desired zero reference on any function or range.

#### 2/4-terminal ohms.

Resistance readings are easy with the 191; not only does it have  $1\text{m}\Omega$  sensitivity, but it has automatic 2-wire/4-wire ohms. There are no links or switches; simply hook up the leads.

#### ACV options

Choice of either average-responding (Model 1910) or TRMS (Model 1920) is available. Model 1910 provides four ACV ranges from  $10\mu\text{V}$  resolution to 1000V full scale, and can be ordered with the 191 or installed later. Model 1920 with TRMS offers high accuracy for non-sinusoidal waveforms with crest factors up to 3. Model 1910 with average response offers even better accuracy at lower cost for use on sine waves. The Model 1910 or 1920 options can be field installed requiring partial recalibration after installation. To order Model 191 with option installed, specify 191/1910 or 191/1920.

### DC VOLTS

RANGE	RESOLUTION	ACCURACY ±(% rdg + digits)		TEMPERATURE COEFFICIENT ±(% rdg + digits)/°C 0°-18°C & 28°-50°C	INPUT RESISTANCE	MAXIMUM ALLOWABLE INPUT	SETTLING TIME <sup>3</sup>
		24 HR., 22°-24°C	1 YR., 18°-28°C				
200mV	1 μV	0.005 + 2 d <sup>1</sup>	0.007 + 3d <sup>1</sup>	0.0007 + 1.6d	> 1000MΩ	1200V <sup>2</sup>	0.5s <sup>4</sup>
2 V	10 μV	0.004 + 1.5d	0.007 + 2d	0.0007 + 0.2d	> 1000MΩ	1200V <sup>2</sup>	0.5s
20 V	100 μV	0.004 + 1.5d	0.010 + 2d	0.0008 + 0.2d	10MΩ	1200V	0.5s
200 V	1mV	0.004 + 1.5d	0.010 + 2d	0.0008 + 0.2d	10MΩ	1200V	0.5s
1200 V	10mV	0.005 + 1.5d	0.010 + 2d	0.0012 + 0.2d	10MΩ	1200V	0.5s

NMRR: Greater than 60dB at 50 and 60Hz.

CMRR: Greater than 120dB at DC, 50 at 60Hz (with 1kΩ in either lead).

<sup>1</sup>With zero set by null function.

<sup>2</sup>To within 5 digits of final reading.

<sup>3</sup>1 minute max., 700V continuous.

<sup>4</sup>1.6s for input changes less than 10μV.

### AC VOLTS (Option 1910)

RANGE	RESOLUTION	ACCURACY ±(% of rdg + digits)			
		1 YEAR, 18°-28°C (Above 1000 counts) <sup>1</sup>		±(%rdg + digits)/°C 0°-18°C & 28°-50°C	
		50Hz-20kHz	20-50Hz & 20kHz-100kHz	50Hz-20kHz	20-50Hz & 20kHz-100kHz
2V	10 μV	0.1 + 10	1.0 + 20	0.015 + 0.5	0.05 + 0.5
20V	100 μV	0.1 + 10	1.0 + 20	0.015 + 0.5	0.05 + 0.5
200V	1mV	0.1 + 10	1.0 + 20	0.015 + 0.5	0.05 + 0.5
1000V	10mV	0.15 + 10 <sup>2</sup>	1.0 + 20 <sup>3</sup>	0.020 + 0.5 <sup>2</sup>	0.05 + 0.5 <sup>3</sup>

RESPONSE: Average, calibrated in rms of a sine wave.

MAXIMUM ALLOWABLE INPUT: 1000V rms sine or DC, 2 × 10<sup>7</sup>V•Hz.

SETTLING TIME: Less than 1.3s to within 0.05% of final reading for zero to full-scale step input.

BENCH READING RATE: 2/s.

CMRR: Greater than 60dB at DC, 50 & 60Hz (1kΩ in either lead).

INPUT IMPEDANCE: 2MΩ shunted by less than 50pF.

<sup>1</sup>With input shorted, display reads approximately 20 digits.

<sup>2</sup>50Hz-10kHz.

<sup>3</sup>20Hz-50Hz & 10kHz-20kHz.

### TRMS AC VOLTS (Option 1920)

RANGE	RESOLUTION	ACCURACY ±(% rdg + counts) 1YR., 18°-28°C			
		20-50Hz*	50Hz-10kHz*	10kHz-20kHz*	20kHz-100kHz**
2V	10 μV	1 + 100	0.25 + 100	0.35 + 150	1 + 500
20V	100 μV	1 + 100	0.25 + 100	0.35 + 150	1 + 500
200V	1mV	1 + 100	0.25 + 100	0.35 + 150	1 + 500
700V	10mV	1 + 100	0.35 + 100	0.5 + 150	1 + 500

\*Above 2000 counts. \*\*Above 20000 counts; 3% typical below 20000.

CREST FACTOR: Rated accuracy to 3 at full range, increasing down-range; specified for pulse waveforms with width at least 10μs.

RESPONSE: True root mean square.

3dB BANDWIDTH: 500kHz typical.

CMRR: Greater than 60dB at 50Hz & 60Hz (1kΩ unbalance).

MAXIMUM INPUT: 1000V peak AC + DC, 2 × 10<sup>7</sup>V•Hz.

SETTLING TIME: 0.5s to within 0.1% of final reading.

INPUT IMPEDANCE: 2MΩ shunted by less than 50pF.

TEMPERATURE COEFFICIENT (0°-18°C & 28°-50°C): Less than ±(0.1 × applicable accuracy specification)/°C.

### OHMS

RANGE	RESOLUTION	ACCURACY ±(% rdg + digits)		TEMPERATURE COEFFICIENT ±(% rdg + digits)/°C 0°-18°C & 28°-50°C	MAXIMUM OUTPUTS		SETTLING TIME <sup>3</sup>	4-TERMINAL LEAD RESISTANCE <sup>4</sup>
		24 HR., 22°-24°C	1YR., 18°-28°C		I short	V open		
200 Ω	1mΩ	0.006 + 2 d <sup>1</sup>	0.012 + 3d <sup>1</sup>	0.0015 + 2 d	-4 mA	-400mV	1s <sup>3</sup>	7Ω
2 kΩ	10mΩ	0.006 + 1.5d	0.012 + 2d	0.0015 + 0.2d	-4 mA	-4 V	1s	22Ω
20 kΩ	100mΩ	0.006 + 1.5d	0.012 + 2d	0.0015 + 0.2d	-400 μA	-4 V	1s	70Ω
200 kΩ	1 Ω	0.006 + 1.5d	0.012 + 2d	0.0015 + 0.2d	-40 μA	-4 V	1s	220Ω
2000 kΩ	10 Ω	0.01 + 1.5d	0.03 + 2d	0.002 + 0.2d	-4 μA	-4 V	1s	700Ω
20MΩ	100 Ω	0.04 + 1.5d	0.08 + 2d	0.006 + 0.2d	-0.4 μA	-4 V	2s	2200Ω

CONFIGURATION: 2-terminal or 4-terminal.

MAXIMUM ALLOWABLE INPUT: 360V peak, 250V rms.

<sup>1</sup>With zero set by null function.

<sup>3</sup>3s for input changes less than 10mΩ.

<sup>2</sup>To within 5 digits of final reading.

<sup>4</sup>Max. resistance per lead for additional 1 digit error.

### GENERAL

NULL: Pushbutton allows zeroing of on-scale readings. Front panel annunciator indicates null mode.

DISPLAY: Six 0.5" LED digits with appropriate decimal.

CONVERSION SPEED: 4 rdg/s on DCV.

3 rdg/s on Ω.

2 rdg/s on ACV.

POLARITY: Automatic; minus indicated, plus implied.

RANGING: Manual.

OVERLOAD INDICATION: Display indicates polarity and overrange digit only.

INVALID RANGE/FUNCTION SELECTION: Display reads -1EEEE.

ISOLATION: Input LO to power line ground, greater than 1000MΩ shunted by approx. 300pF. Maximum input between LO and power line ground, 1400V peak, 5 × 10<sup>5</sup>V•Hz.

WARMUP: 1 hour to rated accuracy.

ENVIRONMENTAL LIMITS: Operating: 0°-50°C, 0%-80% relative humidity up to 35°C. Storage: -25°C to 65°C.

POWER: 105-125V or 210-250V (internal switch selected), 50-60Hz, 20VA maximum; 90-110V available.

INPUT CONNECTORS: 5-way binding posts.

DIMENSIONS, WEIGHT: 85mm high × 235mm wide × 275mm deep (3½" × 9¼" × 10¾"). Net weight 2.3kg (5 lbs.).

ACCESSORY SUPPLIED: Instruction/Service Manual.

ACCESSORIES AVAILABLE:

Model 1010: Single Rack Mounting Kit

Model 1017: Dual Rack Mounting Kit

Model 1301: Temperature Probe

Model 1600A: High Voltage Probe (40kV)

Model 1641: Kelvin Test Leads

Model 1651: 50-Ampere Shunt

Model 1681: Clip-On Test Lead Set

Model 1682A: RF Probe

Model 1683: Universal Test Lead Set

Model 1684: Hard Shell Carrying Case

Model 1685: Clamp-On Current Probe

Model 1691: General Purpose Test Leads

Model 1901: Current Adapter

Model 1910: Averaging AC Volts Option

Model 1913: Calibration Cover

Model 1919: Spare Parts Kit

Model 1920: TRMS AC Volts Option

# 192/Programmable DMM

6½-Digit System/Bench

- Front panel math functions
- 100-point data logging
- 0.007% DCV accuracy



The Model 192 offers the systems/bench DMM user more practical measurement capability than competitively priced DMMs. The unit has 6½-digit resolution and, with the optional IEEE-488 bus, has 100nV DC sensitivity.

Additional measurement capability is demonstrated by the 192's optional AC response choices. The Model 1920 TRMS plug-in card

can be programmed from the front panel or the IEEE-488 bus for AC coupling. The Model 1910 Averaging AC option provides higher accuracy for pure sinusoidal waveforms.

The Model 192's front panel zero is activated by one button. Zero offset is automatically scaled when the range is changed, and different offsets are saved for each function.

## FRONT PANEL PROGRAMS

PROGRAM	NAME	DESCRIPTION
0	CLEAR	Cancels Programs 3 through 7.
1	RESOLUTION	Selects 5½- or 6½-digit resolution.
2	FILTER	Selects extra digital filtering.
Programs 1 and 2 may be used with Programs 3 through 7.		
3	OFFSET/SCALE	Displays the result of $Y=sX+b$ ; s and b entered on front panel. Allows readout in engineering units from such inputs as strain gages.
4	% DEVIATION	Displays % deviation from entered value; for example, calibrating voltage to within 0.01% of a nominal value.
5	MIN/MAX	Remembers minimum and maximum readings for front panel recall.
6	HI/LO/PASS	Displays HI, LO or PASS as defined by entered limits. A status output is available with the 1923 IEEE-488 option, which can drive relays for interfacing with mechanical handlers and sorting equipment. This function adds programmable controller capabilities to a systems/bench DMM.
7	DATA LOGGER	Saves up to 100 readings for front panel or IEEE-488 recall. Reading interval is programmable from the front panel from 1 second to 1 hour.

## MODEL 1923 IEEE-488 INTERFACE (Option)

### I. IEEE-488 BUS IMPLEMENTATION:

**Multiline Commands:** DCL, SDC, GET, LLO, GTL, UNT, UNL, SPE, SPD.

**Uniline Commands:** IFC, REN, EOI, SRQ, ATN.

**Interface Functions:** SH1, AH1, T5, TE0, L4, LE0, SR1, RL1, PP0, DC1, DT1, C0, E1.

**Programmable Parameters:** Function, Range, Zero, Trigger Modes, Delay, EOI State, SRQ Bus Response, Data Terminators, Data Store to 100 Readings.

**Conversion Rates:** Nine different conversion rates may be selected; fastest modes for DC volts are:

RESOLUTION	INTEGRATION PERIOD	TRIGGER TO FIRST BYTE OUT	READINGS PER SECOND
4½ digits	4.4ms	27ms	31
5½ digits	16.67ms*	39ms	22
6½ digits	100ms	134ms	2.2

\*20ms at 50Hz.

**Data String:** 16 bytes (excluding terminators).

**4½-Digit Accuracy:**  $\pm(0.015\% + 1 \text{ count})$  for 1 year on DCV & Ohms (below 2000kΩ).

**Address Modes:** TALK ONLY and ADDRESSABLE.

### II. STATUS PORT:

Separate port providing function and HI/LO/PASS outputs (open collector, 100mA sink).



# Programmable DMM/192

6½-Digit System/Bench

## DC VOLTS

RANGE	RESOLUTION			INPUT RESISTANCE	5½-DIGIT ACCURACY ±(% of rdg + counts)			TEMP. COEFFICIENT ±(% rdg+counts)/6°C 0°-18°C & 28°-50°C
	6½*	5½	4½**		24 HR. 23°C ±1°C	90 DAYS 18°-28°C	1 YEAR 18°-28°C	
0.2V	100 nV	1 µV	10 µV	> 1000MΩ	0.004+2***	0.005+2***	0.009+2***	0.0003+1
2 V	1 µV	10 µV	100 µV	> 1000MΩ	0.003+1.5	0.005+1.5	0.007+1.5	0.0003+0.1
20 V	10 µV	100 µV	1mV	> 1000MΩ	0.003+1	0.005+1	0.009+1	0.0003+0.1
200 V	100 µV	1mV	10mV	10MΩ	0.004+2	0.007+2	0.010+2	0.0003+0.1
1200 V	1mV	10mV	100mV	10MΩ	0.004+1	0.007+1	0.011+1	0.0003+0.1

\*Multiply digit error by 10; 100nV on IEEE only. \*\*Using 1923 Interface. \*\*\*After pushbutton zeroing.

MAXIMUM ALLOWABLE INPUT: 1200V peak.

NMRR: Greater than 60dB at 50 or 60Hz.

CMRR: Greater than 120dB at DC and 50 or 60Hz (with 1kΩ in either lead).

BENCH READING RATE: 8/s.

SETTLING TIME: 250ms to within 6 digits at 5½-digit resolution.

## AC VOLTS (Option 1910)

RANGE	RESOLUTION			5½-DIGIT ACCURACY ±(% of rdg + counts)				
	6½*	5½	4½**	1 YEAR, 18°-28°C (above 1000 counts)	50Hz-20kHz	20Hz-50Hz & 20kHz-100kHz	50Hz-20kHz	TEMPERATURE COEFFICIENT ±(% rdg + counts)/°C 0°-18°C & 28°-50°C
2V	1 µV	10 µV	100 µV	0.1 +10	1+20	1+20	0.015+0.5	0.05+0.5
20V	10 µV	100 µV	1mV	0.1 +10	1+20	1+20	0.015+0.5	0.05+0.5
200V	100 µV	1mV	10mV	0.1 +10	1+20	1+20	0.015+0.5	0.05+0.5
1000V	1mV	10mV	100mV	0.15+10†	1+20‡	1+20‡	0.020+0.5†	0.05+0.5‡

\*Multiply digit error by 10. \*\*Using Model 1923 Interface.

RESPONSE: Average, calibrated in rms of a sine wave.

MAXIMUM ALLOWABLE INPUT: 1000V rms sine or DC, 2 × 10<sup>7</sup>V•Hz.

CMRR: Greater than 60dB at DC, 50 & 60Hz (1kΩ in either lead).

‡150Hz-10kHz. †20Hz-50Hz & 10kHz-20kHz.

INPUT IMPEDANCE: 2MΩ shunted by less than 50pF.

BENCH READING RATE: 2/s.

SETTLING TIME: Less than 1.3s to within 0.05% of final reading.

## TRMS AC VOLTS (Option 1920)

RANGE	RESOLUTION			5½-DIGIT ACCURACY ±(%rdg + counts) 1 YR., 18°-28°C			
	6½	5½	4½	20-50Hz*	DC, 50Hz-10kHz*	10kHz-20kHz	20kHz-100kHz**
2V	1 µV	10 µV	100 µV	16*100	0.25+100	0.35+300	1+500
20V	10 µV	100 µV	1mV	1+100	0.25+100	0.35+300	1+500
200V	100 µV	1mV	10mV	1+100	0.25+100	0.35+300	1+500
700V	1mV	10mV	100mV	1+100	0.35+100	0.5 +300	1+500

\*Above 2000 counts.

\*\*Above 2000 counts; 3% +500 typical below 20000.

RESPONSE: True root mean square.

CREST FACTOR: Rated accuracy to 3 at full range, specified for pulse waveforms with width at least 10µs.

AC+DC: Add 60 counts to specified accuracy.

MAXIMUM INPUT: 1000V peak AC + DC, 2 × 10<sup>7</sup>V•Hz.

SETTLING TIME: 0.5s to within 0.1% of final reading.

INPUT IMPEDANCE: 2MΩ shunted by less than 50pF.

TEMPERATURE COEFFICIENT (06°-18°C & 28°-50°C): Less than ±(0.1 × applicable accuracy specification)/°C below 50kHz; (0.2×) for 50kHz to 100kHz.

3dB BANDWIDTH: 500kHz typical.

CMRR: Greater than 60dB at 50 and 60Hz (1kΩ unbalance).

## OHMS

RANGE	RESOLUTION			MAXIMUM OUTPUT		5½-DIGIT ACCURACY ±(% of rdg 6 <sup>4</sup> counts)			TEMP. COEFFICIENT ±(% rdg+counts)/°C 0°-18°C & 28°-50°C
	6½*	5½	4½**	I SHORT	V OPEN	24 HR. 23°C ±1°C	90 DAYS 18°-28°C	1 YR. 18°-28°C	
0.2 kΩ	100 µΩ	1mΩ	10mΩ	-5 mA	-0.5V	0.0035+2***	0.007+2***	0.010+2***	0.001 +0.7
2 kΩ	1mΩ	10mΩ	100mΩ	-5 mA	-5 V	0.0035+2	0.007+2	0.010+2	0.001 +0.1
20 kΩ	10mΩ	100mΩ	1 Ω	-500 µA	-5 V	0.0035+1	0.007+2	0.010+2	0.001 +0.1
200 kΩ	100mΩ	1 Ω	10 Ω	-50 µA	-5 V	0.0035+1	0.007+2	0.010+2	0.001 +0.1
2000 kΩ	1 Ω	10 Ω	100 Ω	-5 µA	-5 V	0.005 +1	0.010+2	0.010+2	0.0012+0.1
20 MΩ	10 Ω	100 Ω	1 kΩ	-0.5 µA	-5 V	0.040 +1	0.070+1	0.070+1	0.01 +0.1

\*Multiply digit error by 10; 100µΩ on IEEE only. \*\*Using 1923 Interface. \*\*\*After pushbutton zeroing.

CONFIGURATION: Automatic 2- or 4-terminal.

MAXIMUM ALLOWABLE INPUT: 360V peak or 250V rms.

BENCH READING RATE: 8/s on 0.2kΩ-2000kΩ ranges; 4/s on 20MΩ range.

SETTLING TIME: 250ms to within 6 counts at 5½-digit resolution on 0.2kΩ-200kΩ ranges; 500ms on 20MΩ range.

## GENERAL

RANGING: Manual or Fast Autoranging (less than 150ms per range change on DCV).

ZERO: Pushbutton zeroing of offsets.

DISPLAY: Seven 0.5-inch LED digits with appropriate decimal point.

OVERRRANGE INDICATION: Display indicates polarity and OFLO.

ISOLATION: Input LO to IEEE LO or power line ground: 1400V peak, 5 × 10<sup>5</sup>V•Hz; greater than 10<sup>9</sup>Ω paralleled by 1200pF.

WARMUP: 2 hours to rated accuracy.

ENVIRONMENTAL LIMITS: Operating: 0°-50°C, 0% to 80% relative humidity up to 35°C. Storage: -25°C to 65°C.

POWER: 105-125 or 210-250 volts (internal switch selected), 50Hz-400Hz, 30V•A maximum.

INPUT CONNECTORS: 5-way binding posts.

DIMENSIONS, WEIGHT: 127mm high × 216mm wide × 359mm deep (5" × 8½" × 14¼"). Net weight 3.4kg (7.5 lbs.).

## ACCESSORIES AVAILABLE:

- Model 1019A: Universal Rack Mounting Kit
- Model 1301: Temperature Probe
- Model 1600A: High Voltage Probe
- Model 1641: Kelvin Test Lead Set
- Model 1651: 50-Ampere Shunt
- Model 1681: Clip-On Test Lead Set
- Model 1682A: RF Probe
- Model 1683: Universal Test Lead Kit
- Model 1685: Clamp-On Current Probe
- Model 1910: Averaging AC Volts Option
- Model 1920: TRMS AC Volts Option
- Model 1923: IEEE-488 Interface
- Model 1924: Rear Input Adapter
- Model 7008-3: IEEE-488 Cable (3 ft.)
- Model 7008-6: IEEE-488 Cable (6 ft.)

# 195/System DMM

5½-Digit System/Bench

- 5 full functions
- Front and rear panel inputs
- Standard IEEE-488, digital calibration, storage buffer



The Model 195 System DMM is a fully programmable instrument with 5½-digit resolution. In standard configuration, the Model 195 is capable of DC voltage measurements between 100nV and 1000V, and 2-terminal and 4-terminal resistance measurements between 100μΩ and 20MΩ. With the optional Model 1950 ACV, ACA and DCA option installed, the Model 195 can make TRMS AC voltage measurements from 1μV to 700V, AC current measurements between 1nA and 2A and DC current measurements from 100pA to 2A. The versatility of the Model 195 is further enhanced by the inclusion of a standard IEEE-488 interface. A highlight of Model 195 operation is its digital calibration feature which allows the user to easily perform calibration from the front panel or via the IEEE bus.

## Data storage

A data storage buffer is included to allow up to 100 readings to be internally stored at a user-selected rate. The buffer can also be integrated at any time for the highest, lowest and the average of the readings stored. The buffer may be read and controlled from the front panel or over the IEEE-488 bus.

## Front and rear panel input terminals

Input terminals are duplicated on the front and rear panels. The selected set of inputs is controlled by a rear panel switch.

## Trigger input and output

The Model 195 may be triggered to take readings by applying an external trigger pulse or by pushing a front panel button. A separate output pulse, which is active when the instrument completes a reading, is also available on the rear panel.

## IEEE-488 BUS IMPLEMENTATION

Multiline Commands: DCL, LLO, SDC, GET, GTL, UNT, UNL, SPE, SPD.

Uniline Commands: IFC, REN, EOI, SRQ, ATN.

Interface Functions: SH1, AH1, T5, TE0, L4, LE0, SR1, RL1, PP0, DC1, DT1, C0, E1.

Programmable Parameters: Range, Function, Zero, Integration Period, Averaging, EOI, Trigger, Terminator, Delay\*, 100-rdg. Storage, Calibration, Display, Multiplex Off, Status, Service Request, Self Test, Output Format.

\*First reading is correct when step input is coincident with trigger.

## Conversion Rates (DC Volts):

USEABLE RESOLUTION	INTEGRATION PERIOD	TRIGGER TO FIRST BYTE OUT	MAXIMUM READING RATE†
3½-Digit	3.3 ms	17ms	76
4½-Digit	16.66ms‡	30ms	36
5½-Digit	100 ms	114ms	9

Address Modes: TALK ONLY and ADDRESSABLE. †Readings/second. ‡120ms at 50Hz.

## FRONT PANEL PROGRAMS

- 0 Clear - Cancels program mode.
- 1 Non-volatile RAM storage - Store programs 3, 4, 5 and 8 data in NVRAM
- 2 Multiplex - Defeats input amplifier multiplexing.
- 3 IEEE bus mode - ADDRESSABLE and TALK ONLY entry.
- 4 Line frequency - Selects 50Hz or 60Hz operation.
- 5 Calibration - Performs digital calibration.
- 6 Extended programs - Enables entry to optional expansion programs.
- 7 Data logger - Allows 100-reading storage at 9 programmable rates; also stores highest, lowest and average reading.
- 8 Diagnostics - Troubleshooting aid and self-test.
- 9 Trigger - Enables front panel or external triggering.

### DC VOLTS

RANGE	RESOLUTION	INPUT RESISTANCE	ACCURACY††		TEMPERATURE COEFFICIENT
			±(%rdg+counts)	±(%rdg+counts)/°C	
			24 Hr.,	1 Yr.,	0°-18°C & 28°-50°C
20mV	100 nV	>1 GΩ	0.01+40	0.025+40	0.003+2
200mV	1 μV	>1 GΩ	0.01+6	0.025+6	0.003+0.5
2 V	10 μV	>1 GΩ	0.01+8	0.020+8	0.003+0.5
20 V	100 μV	10MΩ	0.01+6	0.030+6	0.003+0.5
200 V	1mV	10MΩ	0.01+8	0.025+8	0.003+0.5
1000 V	10mV	10MΩ	0.01+6	0.025+6	0.003+0.5

†After pushbutton or bus zeroing.

‡In 4<sup>1</sup>/<sub>2</sub>-digit mode, counts=±2 (except ±4 on 20mV range after zeroing).

NMR: Greater than 60dB at 50 or 60Hz.

CMRR: Greater than 120dB at DC and 50 or 60Hz (with 1kΩ in either lead).

MAXIMUM ALLOWABLE INPUT: 1000V peak.

BENCH READING RATE: 5 readings/second.

### TRMS AC VOLTS (Option 1950)

RANGE	RESOLUTION	20Hz-45Hz	ACCURACY (1 YEAR)†		
			±(%rdg+counts)	±(%rdg+counts)	±(%rdg+counts)
18°-28°C					
200mV†	1 μV	0.8+200	0.6+300	0.7+200	2.0+300
2 V	10 μV	0.8+200	0.6+300	0.7+200	2.0+250
20 V	100 μV	0.8+200	0.6+300	0.7+200	1.5+250
200 V	1mV	0.8+200	0.6+300	0.7+200	1.5+250
700 V	10mV	0.8+200	0.6+300	0.7+200	1.5+250

†In 4<sup>1</sup>/<sub>2</sub>-digit mode, divide count error by 10.

‡Above 1mV.

TEMPERATURE COEFFICIENT (0°-18°C & 28°-50°C): Less than ±(0.1× applicable accuracy specification)/°C.

RESPONSE: True root mean square, AC coupled.

CREST FACTOR (ratio of peak to rms): Up to 3:1 allowable.

INPUT IMPEDANCE: 2MΩ shunted by less than 75pF.

MAXIMUM ALLOWABLE INPUT: 1000V peak, 10°V•Hz.

BENCH READING RATE: 3 readings/second.

CMRR: Greater than 60dB at DC, 50 or 60Hz (with 1kΩ in either lead).

BANDWIDTH: -3dB at 250kHz typical.

### OHMS

RANGE	RESOLUTION	OUTPUT		ACCURACY††		TEMPERATURE COEFFICIENT
		I short	Vopen	±(%rdg+counts)	±(%rdg+counts)	
24 Hr., 1 Yr., ±(%rdg+counts)/°C						
20 Ω	100 μΩ	-2mA	-2V	0.015+25	0.025+25	0.003+2
200 Ω	1mΩ	-2mA	-2V	0.015+7	0.025+7	0.003+0.5
2 kΩ	10mΩ	-2mA	-2V	0.015+5	0.022+5	0.003+0.5
20 kΩ	100mΩ	-20 μA	-2V	0.015+7	0.025+7	0.003+0.5
200 kΩ	1 Ω	-20 μA	-2V	0.015+5	0.022+5	0.003+0.5
2MΩ	10 Ω	-200 nA	-2V	0.03+7	0.050+7	0.015+1
20MΩ	100 Ω	-200 nA	-2V	0.06+5	0.100+5	0.025+1

†After pushbutton or bus zeroing.

‡In 4<sup>1</sup>/<sub>2</sub>-digit mode, counts=±2 (except ±4 on 20Ω range after zeroing).

CONFIGURATION: Automatic 2- or 4-terminal.

MAXIMUM ALLOWABLE INPUT: 360V peak or 250V rms.

BENCH READING RATE: 3 readings/second except 20MΩ range, 1 reading/second.

### DC AMPS (Option 1950)

RANGE	RESOLUTION	ACCURACY (1 YEAR)††	TEMPERATURE COEFFICIENT	MAXIMUM VOLTAGE BURDEN
18°-28°C				
20 μA	100pA	0.14+40†	0.01+2	0.03 V
200 μA	1nA	0.09+10	0.01+0.5	0.25 V
2mA	10nA	0.09+10	0.01+0.5	0.25 V
20mA	100nA	0.09+10	0.01+0.5	0.25 V
200mA	1μA	0.09+10	0.01+0.5	0.28 V
2 A	10μA	0.09+10	0.01+0.5	1 V

†In 4<sup>1</sup>/<sub>2</sub>-digit mode, counts=±2 (except ±4 on 20μA range after zeroing).

‡After pushbutton or bus zeroing.

OVERLOAD PROTECTION: 2A fuse (250V), externally accessible.

BENCH READING RATE: 5 readings/second.

### TRMS AC AMPS (Option 1950)

RANGE	RESOLUTION	ACCURACY (1 YEAR)††	TEMPERATURE COEFFICIENT	MAXIMUM VOLTAGE BURDEN
45Hz-10kHz				
18°-28°C				
200 μA	1nA	0.6+300	0.04+10	0.25V
2mA	10nA	0.6+300	0.04+10	0.25V
20mA	100nA	0.6+300	0.04+10	0.25V
200mA	1μA	0.6+300	0.04+10	0.28V
2 A	10μA	0.6+300	0.04+10	1 V

†In 4<sup>1</sup>/<sub>2</sub>-digit mode, divide count error by 10.

‡Above 0.5% of range.

RESPONSE: True root mean square, AC coupled.

CREST FACTOR (ratio of peak to rms): Up to 3:1 allowable.

OVERLOAD PROTECTION: 2A fuse (250V), externally accessible.

BENCH READING RATE: 3 readings/second.

### GENERAL

DISPLAY: Six 0.5" LED digits with decimal point, exponent and polarity. Function and IEEE bus status also displayed.

RANGING: Manual or fast autoranging (150ms per range change on DCV).

ISOLATION: Input LO to IEEE LO or power line ground: 500V max, 5 × 10<sup>5</sup> V•Hz; greater than 10<sup>9</sup>Ω paralleled by 300pF.

WARMUP: 1 hour to rated accuracy.

OPERATING ENVIRONMENT: 0°-50°C, 0% to 80% relative humidity up to 35°C.

STORAGE ENVIRONMENT: -25° to 65°C.

POWER: 105-125V or 210-250V (internal switch selected), 50Hz to 400Hz, 24V•A maximum. 90-110V and 180-220V version available upon request.

CONNECTORS: Analog: Switch selectable front or rear, 5-way gold plated binding posts. Digital: "Trigger" input and "Voltmeter Complete" output on rear panel, BNCs.

DIMENSIONS, WEIGHT: 127mm high × 216mm wide × 359mm deep (5" × 8<sup>1</sup>/<sub>2</sub>" × 14<sup>1</sup>/<sub>2</sub>"). Net weight 3.2kg (7 lbs.).

### ACCESSORIES AVAILABLE:

Model 1019A: Universal Fixed Rack Mounting Kit

Model 1019S: Universal Slide Rack Mounting Kit

Model 1600A: High Voltage Probe

Model 1641: Kelvin Test Lead Set

Model 1651: 50-Ampere Shunt

Model 1681: Clip-On Test Lead Set

Model 1682A: RF Probe

Model 1683: Universal Test Lead Set

Model 1685: Clamp-On Current Probe

Model 1950: TRMS ACV, ACA, DCA Option

Model 7008-3: IEEE-488 Cable, 3 ft. (0.9m)

Model 7008-6: IEEE-488 Cable, 6 ft. (1.8m)

Model 7051-1: BNC to BNC Cable (1 ft.)

Model 7051-3: BNC to BNC Cable (3 ft.)

Model 7051-5: BNC to BNC Cable (5 ft.)

# 195T/System DMM

## System/Bench

- High accuracy
- Dual scale temperature measurement
- Front panel calibration

The Model 195T is an enhanced version of the Model 195 that includes temperature measuring capabilities. The Model 195T is capable of temperature measurements in the range of  $-220^{\circ}\text{C}$  to  $+630^{\circ}\text{C}$  ( $-360^{\circ}\text{F}$  to  $+1100^{\circ}\text{F}$ ). The instrument is designed to work with platinum RTD probes. Because RTD probes have predictable resistance change with temperature, temperature measurements are made with a greater degree of accuracy than is possible with thermistor type probes. The temperature measuring mode is easily entered from the front panel or over the IEEE bus. Sophisticated software automatically measures the probe resistance and calculates the reading. Temperature readout may be obtained in either  $^{\circ}\text{C}$  or  $^{\circ}\text{F}$ . Readings are available on the display and over the IEEE bus. Temperature calibration may be performed from the front panel. Probe errors near  $0^{\circ}\text{C}$  ( $32^{\circ}\text{F}$ ) can be minimized with the calibration procedure. Probe resistance measurements are performed using the 4-terminal method to minimize the effects of lead resistance.



TEMPERATURE (5½ DIGITS)		RESOLUTION	4-WIRE ACCURACY <sup>1</sup> ± (%rdg + counts) 1 YR., 18°-28°C	TEMPERATURE COEFFICIENT ± (%rdg + counts)/°C 0°-18°C & 28°-50°C
SPAN				
°C				
-200.00° to 230.00°	0.01°	0.03 + 10	0.003 + 0.4	
230.00° to 630.00°	0.01°	0.03 + 40	0.003 + 4	
-220.00° to -200.00°	0.01°	0.03 + 40	0.003 + 4	
°F				
-328.00° to 446.00°	0.01°	0.03 + 18	0.003 + 0.7	
446.00° to 1100.00°	0.01°	0.03 + 72	0.003 + 7	
-360.00° to -328.00°	0.01°	0.03 + 72	0.003 + 7	

<sup>1</sup>Autorange mode, excluding probe errors.

RTD TYPE: 100Ω platinum, DIN 43 760 or IPTS-68 curve conformity,  $\alpha = 0.00380$  to  $0.00395$ , 3- or 4-wire.

MAXIMUM LEAD RESISTANCE (each lead): 4-wire: 200Ω. 3-wire: 20Ω.  
 SENSOR CURRENT: 1.4mA maximum.  
 BENCH READING RATE: 4 readings/second.  
 MAXIMUM COMMON MODE VOLTAGE: 500V (42V with Model 1951 connected).  
 COMMON MODE REJECTION: Less than  $0.005^{\circ}\text{C}/\text{volt}$  at DC, 50Hz and 60Hz (100Ω unbalance, LO driven).  
 MAXIMUM ALLOWABLE INPUT: 360V peak, 250V rms.  
 ACCESSORIES SUPPLIED: Model 1951 Input Adapter, Model 8693 General Purpose/Immersion Probe (4-wire).  
 ACCESSORIES AVAILABLE:  
 Model 1951: Input Adapter  
 Model 8691: Connector Kit (enables connecting to 3- or 4-wire RTDs)  
 Model 8693: General Purpose/Immersion Probe (4-wire)  
 Model 8695: Surface Probe (4-wire)  
 Model 8696: Air/Gas Probe (4-wire)

# DMM Accessories/Selector Guide

	128	130	131	132C 132F	135A	169	177	179A	191	192	195
Rack Mount Kits											
Single						1010	1010	1010	1010		
Dual						1017	1017	1017	1017		
Universal Fixed										1019A	1019A
Universal Slide										1019S	1019S
Probes											
Temperature	1301	1301	1301	8712 <sup>2</sup>	1301	1301	1301	1301	1301	1301	1301
High Voltage	1600A	1600A	1600A	1600A	1600A	1600A	1600A	1600A	1600A	1600A	1600A
RF	1682A	1682A	1682A	1682A	1682A	1682A	1682A	1682A	1682A	1682A	1682A
Current	1685	1685	1685	1685	1685	1685	1685	1685	1685	1685	1685
Carrying Case											
Soft, with Stand	1304	1304	1304	1304	1304						
Deluxe, Heavy Duty	1306	1306	1306	1306	1306	1684	1684	1684	1684		
Holster	8700	8700	8700	8700	8700						
Spare Parts Kit		1309	1309		1359	1699	1779	1919			
Maintenance Kit									1913		
Test Leads											
Kelvin									1641	1641	1641
Clip On	1681	1681	1681	1681	1681	1681	1681	1681	1681	1681	1681
Universal	1683	1683	1683	1683	1683	1683	1683	1683	1683	1683	1683
General Purpose	1691 <sup>1</sup>	1691 <sup>1</sup>	1691 <sup>1</sup>	1691 <sup>1</sup>	1691 <sup>1</sup>	1691 <sup>1</sup>	1691	1691 <sup>1</sup>	1691	1691	1691
Current Options											
Shunt (50A)	1651	1651	1651	1651	1651	1651	1651	1651			1651
TRMS AC				Std.			Std.	Std.	1920	1920	1950
Averaging AC	Std.	Std.	Std.		Std.	Std.			1910	1910	
Output Options											
BCD							1792	1792			
IEEE-488							1793	1793		1923A	Std.
Cables											
BCD							1796	1796			
IEEE-488							7008	7008		7008	7008
Power Options											
Line						1766	Std.	Std.	Std.	Std.	Std.
Battery	Std.	Std.	Std.	Std.	Std.	Std.	1788	1788			
Rear Inputs										1924	Std.

<sup>1</sup>Supplied accessory.

<sup>2</sup>Model 871 Thermometer probes may also be used (see page 41).

# Selector Guide/Thermometers

SENSOR TYPE	MODEL NUMBER	RANGE	RESOLUTION	ACCURACY	INDUSTRY
K Thermocouple	871	-40 to 1999°F	0.1° to 200°, 1° over 200°	±0.25%	Electronics, metals, chemicals
		-40 to 1370°C	0.1° to 200°, 1° over 200°		
J Thermocouple	872	-40 to 1400°F	0.1° to 200°, 1° over 200°	±0.25%	Plastics, paper, petroleum
		-40 to 760°C	0.1° to 200°, 1° over 200°		
Thermistor	865	-70 to 300°F	0.1° to 200°, 1° over 200°	±0.3%	Food, HVAC/plant maintenance, photography, life sciences, electronics
	866	-55 to 150°C	0.1°	±0.3%	
Platinum RTD	868	-360 to 1100°F	0.1° to 200°, 1° over 200°	±0.4°F	Chemicals, petroleum, electronics, life sciences.
	869	-220 to 630°C	0.1° to 200°, 1° over 200°	±0.3°C	

**Thermistor Handheld Thermometer (865, 866):** Highest accuracy and lowest cost up to 150°C.

**RTD Handheld Thermometer (868, 869):** Accuracy and stability from low to moderately high range.

**Thermocouple Handheld Thermometer (871, 872):** Widest range at low cost.

Keithley offers a complete line of professional grade thermometers, from research lab instruments to rugged field service units. Keithley was the first to bring the precision of bench thermometry to handheld meters at an affordable price. We make them rugged as well as accurate. And we put as much into the design and construction of our probes as we do into the meters themselves.

**Models 871 and 872** thermocouple based units satisfy most applications in research, service and manufacturing where wide or high range combined with fast response is necessary. The Model 871's type K input is best for most general purpose applications. Probes are rugged, easily interchanged, and come in a variety of configurations. Model

872's type J input is suited for specific type J applications, including many existing sensor installations.

**Models 865 and 866** thermistor based units offer < 1°C accuracy over the environmental temperature range. They are especially suited to laboratory applications, life sciences, food processing and heating and ventilating.

**Models 868 and 869** are RTD based units. Their 100Ω platinum sensors offer excellent accuracy, more stability and wider temperature range than thermistor units. They are well suited for petrochemical use and broad research applications, as well as precision process monitoring.

## INTRODUCTION

Temperature is one of the most measured physical quantities in the world. Its measurement is essential in industrial process control, engineering, and scientific and biochemical research. Over time, three basic sensors have gained popularity: thermocouples (TCs), resistance temperature detectors (RTDs) and thermistors. Using these sensors to determine temperature requires instruments which accurately measure microvolt or milliohm signals.

Deciding which thermometer to use requires the determination of: 1) the proper sensor; 2) the probe configuration; and 3) the instrumentation required. Table 1 lists the useful temperature ranges of the most popular sensor types, along with their standard limits of error.

The following sections discuss these considerations in depth.

Sensor	Range	Accuracy
Type K Thermocouple	0°C to 1370°C	* ± 2.2°C or 0.75%  t
Type J Thermocouple	0°C to 760°C	* ± 2.2°C or 0.75%  t
2252Ω Thermistor	-80°C to 150°C	± 0.2°C (0°C to 70°C)
100Ω Platinum RTD	-200°C to 630°C	± (0.3°C + 0.5%  t )

\*whichever is greater

## SELECTING THE SENSOR

### Thermocouples

Despite the disadvantages of low sensitivity and moderate accuracy, thermocouples are still the most widely used method of temperature measurement. They feature wide temperature span, up to 1800°C (3270°F) for noble metal types, and low cost. They are available in fine wire for millisecond response times and up to very heavy gauges for durability and high temperatures. Due to their operating principle, they are useful for point sensing temperature measurements.

Thermocouples generate a voltage that is proportional to temperature differences rather than to absolute temperature. Their construction is, simply, two dissimilar metals of known composition electrically connected at one end to form the measurement or "hot" junction. The other ends, although not electrically connected, must be maintained at the same temperature. This isothermal connection is called the reference or "cold" junction.

Since a thermocouple's output is a function of the difference in temperature between the measurement and reference junctions, it is necessary to fix the reference junction at a known temperature if repeatable and accurate measurements are to be made. The National Bureau of Standards publishes thermoelectric voltage vs. temperature tables of many standardized thermocouple wire pairs. These tables fix the reference junction at the ice point of water (0.00°C).

Producing a reference temperature may be feasible in a laboratory environment, but it is impractical for use in handheld instrumentation. The technique used to overcome this limitation is called ice point or cold junction compensation.

Cold junction compensation theory can be best explained by the Thermoelectric Law of Intermediate Temperatures (see Figure 1). It implies that if T2 is the instrument's ambient temperature and T3 is the ice point temperature, then the thermocouple, with its junctions between T1 and ambient, can be compensated by a voltage equivalent to that generated by the same thermocouple if the measurement junction is ambient and the reference junction is at the ice point.

Thermocouples have a very non-linear voltage output over their temperature span. Special electronic circuits are required to compensate for this non-linearity and provide a digital output which conforms very closely to the NBS tables. Typical sensitivities for base metal thermocouples are in the range of 40 to 80μV/°C.

Changing characteristics over time (aging) when used at extremely high temperatures requires frequent replacement of the sensor.

### Resistance Temperature Detectors

RTDs are essentially wire wound resistors, mounted strain-free, that exhibit moderate positive temperature coefficients of resistance vs. temperature. Platinum is the most popular resistance wire used due to its high melting point, chemical stability and very predictable characteristics with temperature. In fact, platinum resistance thermometers are used to interpolate between fixed point temperatures on the International Practical Temperature Scale (IPTS-68) from -259.34°C to 630.74°C.

The most outstanding features of platinum RTDs are their excellent long term stability, high accuracy and repeatability. In most industrial applications it is not as important to know the absolute temperature as it is to be able to repeat that temperature on a month-to-month basis. Typical decalibration drifts are less than 0.1°C per year.

Compared with thermocouples, platinum RTDs do not require cold junction compensation, utilize low-cost copper connections and are fairly linear in response over short intervals. Due to their construction, RTDs are slower responding compared to fine wire thermocouples, operate over lower temperature spans and are area sensitive.

Wire wound sensors are subject to mechanical shock and vibration and have a relatively high cost. Most of their disadvantages have been addressed by the development of thin film platinum elements. Thin film RTDs have 20 to 100 times less volume than wire wounds, substantially improved response time and reduced sensing area. Their construction and the manufacturing process used allow a lower cost and more resistance to shock.

Measuring temperature using RTDs requires measuring resistance. Since the RTD's resistance is 100Ω at 0°C and changes only 0.0385Ω per 0.1°C, several tenths of an ohm of connection lead resistance can be a major source of error. Special circuits have been developed to compensate for lead resistance. The most popular is a 3-wire connection scheme, while 4-wire connections virtually eliminate these errors.

The resistance change of a platinum RTD vs. temperature is described by the Callendar-Van Dusen equation:

$$t = [1/\alpha][(R_t/R_0) - 1] + \delta[t/100][(t/100) - 1] + \beta[(t/100) - 1][t/100]^3$$

for  $t < 0^\circ\text{C}$ ;  $\beta = 0$

where  $R_t$  is the resistance at temperature  $t$ ,  $R_0$  is the resistance at 0°C, and  $\alpha$ ,  $\delta$  and  $\beta$  are constants which are determined from resistance measurements at 3 fixed point temperatures. This equation is the basis for industrial standards such as the internationally recognized German DIN 43 760.

Two of the terms used in the Callendar equation,  $R_0$  and  $\alpha$ , are useful in describing the platinum element.  $R_0$ , the ice point resistance, is available in values from 25Ω to greater than 1000Ω. An  $R_0$  of 100Ω is usually specified in industrial standards. Alpha ( $\alpha$ ) describes the fundamental interval in units of ohms per ohm per °C. The value of  $\alpha$  is determined by the following equation:

$$\alpha = (R_{100} - R_0)/100R_0$$

where  $R_0$  is the resistance at 0°C and  $R_{100}$  is the resistance at 100°C. The value of  $\alpha$  in any given element is influenced primarily by the purity of the annealed platinum used and by any strain placed on the wire

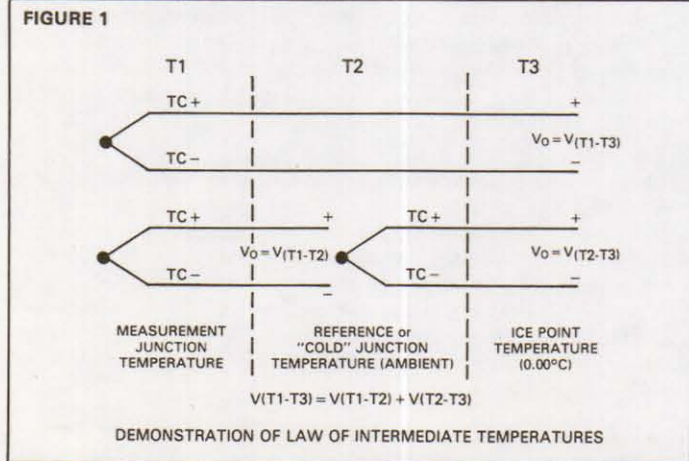

by its construction. To qualify as an interpolation standard the value of  $\alpha$  must not be less than 0.00392. Industrial standards specify a nominal value of 0.00385.

## Thermistors

Thermistors are made from sintered mixtures of metal oxides which exhibit large negative coefficients of resistance change with increasing temperature. Resistance changes of  $-2\%$  to  $-6\%$  per degree Celsius are common, providing high resolution to  $0.01^\circ\text{C}$ . The advantage of high resolution is complicated by the exponential R-T response of the thermistor, changing approximately one decade in resistance over  $50^\circ\text{C}$ . Over the useful range, a thermistor's resistance can change 5 to 6 orders of magnitude, causing problems with the measuring instrument's dynamic range. Several sensor manufacturers have addressed this problem of extreme non-linearity with elements that contain multiple thermistors. These sensors, when used with an external resistance network, provide a linear output deviation of less than  $0.3^\circ\text{C}$  over a  $0^\circ$  to  $100^\circ\text{C}$  range. Although this approach improves linearity, it does so at the expense of sensitivity ( $4\%/^\circ\text{C}$  to  $0.75\%/^\circ\text{C}$ ), increased circuit complexity and cost.

Thermistors are identified by the value of their resistance at  $25^\circ\text{C}$  ( $77^\circ\text{F}$ ). The most popular, those used in Yellow Springs Instruments' (YSI) series 400 probes, is the  $2252\Omega$ . This thermistor is suitable for temperature measurements in the range of  $-80^\circ\text{C}$  ( $-112^\circ\text{F}$ ) to  $150^\circ\text{C}$  ( $302^\circ\text{F}$ ). Using them for measurements above  $150^\circ\text{C}$  can result in damage or unpredictable drift from calibration.

Interchangeability is one of the major advantages of thermistors. The  $2252\Omega$  elements have a unit-to-unit variation of less than  $\pm 0.2^\circ\text{C}$  from  $0^\circ$  to  $70^\circ\text{C}$ .

The resistance-temperature characteristics for negative temperature coefficient thermistors is best characterized by the Steinhart-Hart equation, which is usually presented in terms of T:

$$1/T = a + b[\ln R] + c[\ln R]^3$$

where T is temperature in degrees Kelvin ( $^\circ\text{C} = ^\circ\text{K} - 273.15^\circ$ ) and  $\ln R$  is the logarithm of R to the base e. The a, b and c coefficients are determined measuring R at three temperatures and then solving the resulting three equations simultaneously.

## SELECTING THE PROBE

Once the decision is reached on the sensor type, the probe must be the next consideration. An important characteristic of probe performance is the time constant. This is defined as the amount of time required for the probe to reach 63% of an applied step change in temperature. The response time, to 99% of final value, is equal to five time constants. These specifications are normally associated with testing conditions such as in stirred liquids. Both of these terms may be used interchangeably, so it is important to determine the specific manufacturer's definition.

It is important to note that sensors do not measure surrounding temperatures; they measure their own temperatures. Although this is not a very profound statement, it is often overlooked when making temperature measurements requiring minimal thermal loading. Thermal loading effects are more pronounced with surface temperature measurements than with immersion, penetration or air measurements. Consider measuring the temperature of a heated rubber surface. When the probe is first touched to the surface, heat transfers from the rubber to the sensing element. This transfer effectively cools the surface. If the mass of the probe is sufficiently large and the surface material has poor thermal conductivity, then the heat will be removed faster than it can be replaced. Eventually the surface and probe will settle to an equilibrium temperature; however, it may be several degrees lower than the actual initial surface temperature. Thermal loading can affect the response time when measuring the temperature of other materials.

Probe construction should be rugged, utilizing heavy gauge, strain relieved wire to minimize fraying and breakage. The wall of the stainless steel sheath used to house the sensing element should be thin

enough to produce quick response times, yet thick enough not to be fragile.

## SELECTING THE INSTRUMENTATION

Total measurement error is the sum of both probe and meter errors. The choice of instrumentation is a function of reliability and specifications relative to accuracy. Paging through specifications from several manufacturers can be a tedious process. This section will define these specifications and relate them to actual temperature measurement uncertainty.

Accuracy is the difference, or possible difference, between the displayed reading of an instrument system and an accepted standard. The standards in the case of thermometry are usually published NBS or DIN tables. There are many factors which contribute to the inaccuracy, or measurement uncertainty, of an electronic thermometer.

### 1. Conformity

Since most relationships of sensor output to temperature are non-linear, the thermometer must compensate. The instrument's inability to conform ideally to a published table adds to the instrument's inaccuracy. Conformity is the absolute worst case deviation from a standard sensor curve by the instrument's transfer function over its entire temperature span.

### 2. Calibration

This source of error has many contributors, including resolution, conformity at the calibration point and inaccuracies of the sources used for calibration. Inaccuracy due to resolution is based on the inability to calibrate to less than plus or minus  $1/2$  of a least significant digit. In the case of a thermometer which resolves  $0.1^\circ$ , this error contributes  $\pm 0.05^\circ$ .

### 3. Temperature Drift

Most components' characteristics change with temperature. These changes cause gain or span errors (% of reading) and zero errors (% of full scale, number of least significant digits, or degrees).

### 4. Operating Environment

Humidity can have a drastic effect on the instrument's performance. It is important that the instrument is specified to operate in the environment where it is likely to be used.

### 5. Time Drift

Like temperature coefficient, time also affects component characteristics and is specified in the same manner.

### 6. Repeatability

Repeatability is the ability of the instrument to reproduce the same reading if it is subjected to the same input and operating conditions. It is largely a result of the instrument's internally generated noise and short term time stability.

### 7. Cold Junction

In thermocouple-based thermometers, additional errors are caused by the cold junction compensation circuitry. These errors originate from the inability of the circuit to accurately simulate an ice point referenced thermocouple measuring the ambient temperature. They are normally specified as degrees of error versus ambient temperature change ( $^\circ\text{C}/^\circ\text{C}$  or  $^\circ\text{F}/^\circ\text{F}$ ).

### 8. Resolution

A common source of confusion is the difference between accuracy, repeatability and resolution. Accuracy and repeatability have already been defined. Resolution is the smallest incremental temperature change that the instrument can display. For example, a  $3\frac{1}{2}$ -digit thermometer with a full scale of  $199.9^\circ$  has resolution of  $0.1^\circ$ .

Although repeatability and resolution contribute to the instrument's inaccuracy, they do not assure accuracy. A digital thermometer, therefore, can have good repeatability and high resolution and still have low accuracy.

## Conclusion

Keithley thermometer specifications include all of the previously



mentioned error sources combined into one guaranteed specification. This specification includes conformity, calibration, repeatability, temperature coefficient (18°C to 28°C; 64°F to 82°F), humidity effects (up to 80% RH) and time stability (1 year) errors. Some manufacturers separate these contributions to their instrument's accuracy to make their products appear superior in performance. This complicates the determination of the instrument's uncertainty of measurement. Make certain that all of these error sources are considered before making a decision to purchase.

Keithley specifies accuracy as either a percent of reading plus an offset (in degrees) or simply the total error in degrees. This provides the user with an easy, concise method of determining the limits of uncertainty when making temperature measurements.

## ADDITIONAL SOURCES OF MEASUREMENT ERROR

### Thermocouples

Other instrument characteristics can affect measurement accuracy, although they may not be contained in the general error specification. Input bias current of thermocouple thermometers can be an additional source of error if long thermocouple wires are used. This bias current is normally due to the input amplifier and open sensor detection circuitry. For example, with an input bias current of 200nA ( $2 \times 10^{-7}$ A), an additional 0.1°C of error can be expected with as little as 15 feet of 24 gauge type K thermocouple wire. Extremely low bias currents, however, will not provide an open sensor indication if the insulation on the wire is contaminated by moisture. Keithley thermocouple thermometers have typical input bias currents of less than 25nA.

### RTDs

A major source of uncertainty in the measurement of temperature with RTDs is the resistance of the lead wires that connect the sensor to the instrument. The copper lead wires, which are normally used for platinum RTDs, also have a positive temperature coefficient of resistance. Two wire sensor connections do not provide any distinction between the sensor's resistance change and that of the lead wires.

Several measurement methods have been developed to reduce the effects of lead wire resistance. The most popular has been the Sieman's 3-wire connected Wheatstone bridge (Figure 2) or a modified version of it. In this connection, L1 and L2 (lead resistances) are placed in opposite legs of the bridge. L3 is in series with the measurement indicator, M. The impedance of M is very high, so that no current flows through L3 and, therefore, has no effect on measurement accuracy. R1 and R2 are usually set equal to each other for maximum sensitivity. R3 is a precision decade resistance source. Its value is adjusted until the bridge is in balance. The bridge is balanced when the voltage developed at point A is equal to that at point B. If L1 exactly equals L2, then the value of R3 will be set to the resistance value of the RTD sensor,  $R_T$ .

Two important conditions in the previous discussion are:

1. Lead resistances L1 and L2 are equal.

FIGURE 2

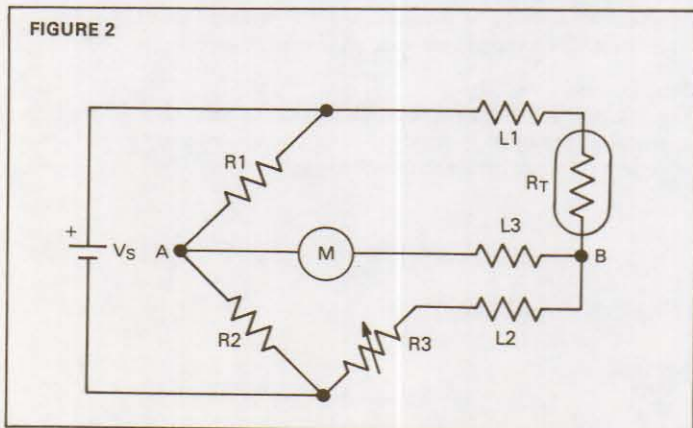

Two different spools of wire from the same manufacturer can vary in resistance by 5%. This means that less than 30 feet of 24 gauge wire can yield an additional zero error of 0.1°C. If stranded lead wires are used, some strands may break over a period of time. This further increases the difference in lead wire resistance. In a practical sense, L1 and L2 also contain the contact resistance of any connectors, which can increase over time with use. These problems may defeat one major advantage of using platinum RTDs: repeatability.

2. For R3 to equal  $R_T$ , the bridge must be in balance.

In handheld RTD thermometers that use this circuit, the bridge must generate a differential output for digitization. This requires an unbalanced condition for other than a 0° reading. Even if the lead resistances are matched, as little as 15 feet of 24 gauge wire can cause an additional span or gain error of 0.2% at full scale (1.2°C at 600°C). Changes in lead resistance with temperature will result in additional span errors.

Because of these unpredictable errors, Keithley RTD thermometers and probes were designed for a four wire measurement (Figure 3). Here, a stable known current is forced through the sensor and the lead resistances, L1 and L4. Due to the high input impedance of the measurement circuit M, there is essentially no current flow and, therefore, no errors caused by L2 and L3. Lead resistance effects are eliminated.

FIGURE 3

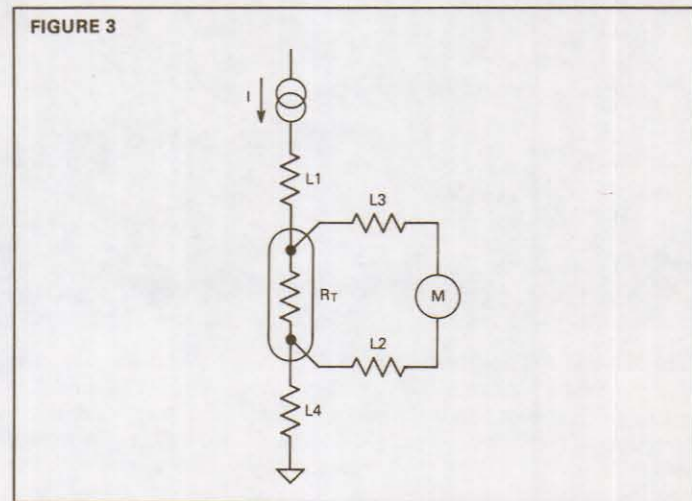

Because of the many 3-wire probes already in use, Keithley's thermometers also have 3-wire measurement capability (see Figure 2). They monitor the voltage across L2 and make the appropriate corrections. Accordingly, the span errors normally associated with 3-wire bridges are eliminated; however, differences in lead and contact resistance will still cause errors. For the highest accuracy and repeatability, only 4-wire RTD temperature measurements should be made.

One additional error source for RTD thermometers is the self-heating of the sensor due to the excitation current of the instrument. To eliminate the need for low noise, high cost amplification, some RTD thermometers use higher sensor currents to maintain large enough signal levels for digitization. If a thin film sensor with a dissipation constant of 2mW/°C is used, a 2mA sensor current will cause a 0.2°C error due solely to sensor self-heating. Keithley handheld RTD thermometers, using the same sensor, cause less than 0.015°C of additional error.

### Thermistors

Self-heating is also a problem with thermistors. Due to their small size, dissipation constants on the order of 1mW/°C are typical. Keithley thermistor thermometers cause self-heating errors of less than 0.01°C from -50° to 100°C.

# 871, 872/Digital Thermometers

871: Type K Thermocouple 872: Type J Thermocouple

- Dual thermocouple inputs
- 0.1° resolution
- Wide choice of probes & accessories



The 871 and 872 are thermocouple (TC) based digital thermometers that put the performance and versatility of expensive bench models in a rugged, low cost handheld package. They offer 0.25% accuracy, temperature measurements to 1370°C (760°C on the 872), dual inputs, selectable scales (°C/°F), 0.1° resolution up to 200°, analog output and low price.

Compared to thermistors, RTDs and semiconductor devices, TCs have the following advantages:

- widest temperature range of thermometry techniques;
- broad sensor interchangeability, as TCs are characterized by standard NBS tables;
- moderate cost and excellent durability.

The 871's type K (NiCr-NiAl) TCs offer low cost with good chemical inertness, physical durability and wide temperature span. The 872's type J TCs provide compatibility with many existing TC applications.

#### Probe matching

Keithley offers a wide range of handheld probes designed to give users

good value and quality. Zero error associated with a particular probe can be easily corrected by adjusting the meter's calibration. Place the probe in an ice-water bath, allow the reading to stabilize, then reset the zero adjustment for a reading of 0.0°C.

#### TC sensor included

The purchase price of a Keithley thermometer also includes a TC sensor, Model 8712 with the 871 or Model 8722 with the 872. You can begin temperature measurements without having to spend additional funds on probes which you may not yet need.

Cold junction electronic circuitry automatically compensates for ambient temperature changes. A special integrating A/D converter corrects for TC non-linearity during each digitization cycle. The resulting conformity to the standard TC voltage table is within 1°C over the entire temperature span of the instrument.

#### Dual channel

The 871 and 872 both feature two inputs for dual channel measurements, and the built-in analog output permits interfacing with chart recorders or other data acquisition devices.

# Digital Thermometers/871, 872

871: Type K Thermocouple 872: Type J Thermocouple

RANGE	TEMPERATURE SPAN	RESOLUTION
200°F	-40.0 to 199.9	0.1°F
2000°F*	-40 to 1999 *	1 °F
200°C	-40.0 to 199.9	0.1°C
1370°C*	-40 to 1370 *	1 °C

\*Maximum ranges and readings on 872 are 1400°F, 760°C.

**INPUTS:** Two type K NiCr-NiAl thermocouples (871), switch selected.  
Two type J Fe-CuNi thermocouples (872), switch selected.

**ACCURACY:**  $\pm(0.25\%$  of reading  $+1^\circ\text{C})$  for one year,  $18^\circ$  to  $28^\circ\text{C}$  ambient. Includes NBS conformity, cold junction compensation and repeatability errors. Excludes thermocouple errors; however, thermocouple errors around  $0^\circ\text{C}$  may be compensated for by internal zero adjustment. Extended span accuracy,  $-40^\circ\text{C}$  to  $-55^\circ\text{C}$ :  $+2^\circ\text{C}$ ,  $-0^\circ\text{C}$ .

**REPEATABILITY:**  $\pm 0.2^\circ\text{C}$  typical for 1 week at constant ambient temperature.

**TEMPERATURE COEFFICIENT:**  $18^\circ$  to  $28^\circ\text{C}$ : Included in accuracy specification.  $0^\circ$  to  $18^\circ\text{C}$  and  $28^\circ$  to  $50^\circ\text{C}$ : Less than  $\pm(0.025\%$  of reading  $+0.1^\circ\text{C})/^\circ\text{C}$ .

**INPUT CURRENT:** 25nA typical; 50nA maximum.

**THERMOCOUPLE LINEARIZATION:** Multi-slope A/D with 11 piece-wise-linear segments from  $-40^\circ\text{C}$  to  $1370^\circ\text{C}$  (9 piece-wise-linear segments from  $-40^\circ\text{C}$  to  $760^\circ\text{C}$  on 872).

**MAXIMUM ALLOWABLE TC INPUT OVERLOAD:** 150V continuous, 300V momentary (10 seconds).

**NORMAL MODE REJECTION RATIO:** Greater than 45dB at 50 & 60Hz.

**COMMON MODE REJECTION RATIO:** Greater than 120dB at DC, 50 & 60Hz.

**THERMOCOUPLE ISOLATION (TC1 to TC2):** 500V peak.

**MAXIMUM COMMON MODE VOLTAGE:** 500V peak to earth (with mV output not connected to earth). Rating applies only to instrument, not to probes or sensors.

## ACCESSORY PROBES

**MATERIALS (unless otherwise noted):**

Thermocouple: Type K (NiCr-NiAl) for 871 probes

Type J (Fe-CuNi) for 872 probes

Sheath: 304 stainless.

Handle: Phenolic.

Cable: Vinyl clad, high temperature, 0.91m (36").

**ACCURACY:**  $\pm 2.2^\circ\text{C}$  or 0.75%, whichever is greater.

## THERMOCOUPLE SENSOR

**Application:** General purpose.

**Insulation Material:** Glass braid.

**Insulation Temperature Rating:**  $480^\circ\text{C}$  continuous.

**Time Constant:** Less than 1 second.

Specify 8712 for 871, 8722 for 872.

## IMMERSION PROBE

**Application:** Liquids, gasses, solids.

**Maximum Temperature:**  $900^\circ\text{C}$  continuous.

**Time Constant:** 1 second (liquids).

**Dimensions:** Handle 104mm (4.1"), Probe 127mm (5.0").

Specify 8713 for 871, 8723 (316 stainless; max. temp  $760^\circ\text{C}$ ) for 872.

## PENETRATION PROBE

**Cable:** Coiled, vinyl clad, high temperature

**Application:** Penetration of soft/semi-soft materials.

**Maximum Temperature:**  $900^\circ\text{C}$  continuous.

**Time Constant:** 2 seconds (liquids).

**Dimensions:** Handle 104mm (4.1"), Probe 76mm (3.0").

Specify Model 8714A for 871. Not available with Type J thermocouple.

## SURFACE PROBE

**Application:** Flat surfaces of solids.

**Maximum Temperature:**  $400^\circ\text{C}$  continuous.

**Time Constant:** 3 seconds (high thermal capacity/conductivity solids).

**Dimensions:** Handle 104mm (4.1"), Probe 152mm (6.0").

Specify 8715 for 871, 8725 for 872.

**DISPLAY:**  $3\frac{1}{2}$ -digit LCD, 15mm (0.6") height, minus polarity & decimal point. Overflow and open thermocouple indication: 3 least significant digits blanked.

**READING RATE:** 2.5 per second.

**BATTERY LIFE, CONTINUOUS:** 100 hours typical with 9V alkaline battery, 50 hours with carbon-zinc (NEDA 1604A).

**BATTERY INDICATOR:** Display reads "BAT" when less than 10% of life remains.

**mV OUTPUT:** Non-linearized, cold-junction compensated thermocouple output (not isolated from selected TC input).

**mV OUTPUT ACCURACY ( $18^\circ$  to  $28^\circ\text{C}$  ambient):**  $\pm 40\mu\text{V}$  ( $\pm 50\mu\text{V}$  on 872) on  $^\circ\text{C}$  ranges;  $\pm 80\mu\text{V}$  ( $\pm 100\mu\text{V}$  on 872) on  $^\circ\text{F}$  ranges;  $0^\circ\text{C} = 0.0\text{mV}$ . Output resistance:  $17\text{k}\Omega$  ( $10\text{k}\Omega$  on 872).

**mV OUTPUT PROTECTION:** 35V DC (42V peak) maximum; mV+ to mV- and selected TC input to mV+ or mV-.

**OPERATING ENVIRONMENT:**  $0^\circ$  to  $50^\circ\text{C}$ , less than 80% relative humidity up to  $35^\circ\text{C}$ ; linearly derate 3% RH/ $^\circ\text{C}$ ,  $35^\circ$  to  $50^\circ\text{C}$ . If the instrument has been stored above  $18^\circ\text{C}$ , it may typically be operated at  $-10^\circ\text{C}$  for 15 minutes.

**STORAGE ENVIRONMENT:**  $-35^\circ$  to  $60^\circ\text{C}$ , less than 90% relative humidity up to  $35^\circ\text{C}$ ; linearly derate 3% RH/ $^\circ\text{C}$ ,  $35^\circ$  to  $60^\circ\text{C}$ . (NOTE: Extended storage of 872 in high humidity environment is not recommended due to iron content of type J connectors.)

**DIMENSIONS, WEIGHT:** 178mm long  $\times$  78mm wide  $\times$  42mm thick (7.0"  $\times$  3.1"  $\times$  1.6"). Net weight 300gm (10.6 oz.).

**ACCESSORIES SUPPLIED:** Battery, operator's manual, Model 8712 Thermocouple Sensor (Model 8722 for 872).

## ACCESSORIES AVAILABLE:

Model 1304: Soft Carrying Case & Stand

Model 1306: Heavy Duty Carrying Case

Model 8700: Carrying Case with Belt Clip & Holster (for 8714A Probe)

Model 8711A: Thermocouple Kit (for 871): Includes Model 8712 Thermocouple Sensor, 6m (20') of AWG -24 Type K duplex TC wire, miniature TC plug/jack, standard TC plug/jack.

Model 8721: Thermocouple Kit (for 872): Includes Model 8722 Thermocouple Sensor, 6m (20') of AWG -24 Type J duplex TC wire, miniature TC plug/jack, standard TC plug/jack.

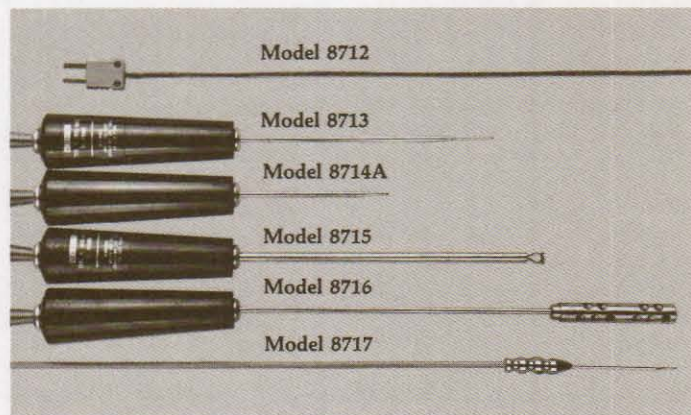

## AIR/GAS PROBE

**Application:** Air, gasses.

**Maximum Temperature:**  $300^\circ\text{C}$  continuous.

**Time Constant:** 3 seconds (5m/s air flow).

**Dimensions:** Handle 104mm (4.1"), Probe 213mm (8.4").

Specify 8716 for 871, 8726 for 872.

## HYPODERMIC PROBE

**Handle:** 304 Stainless

**Application:** Penetration of soft/semisoft materials.

**Maximum Temperature:**  $500^\circ\text{C}$  continuous.

**Time Constant:** 1 second (liquids).

**Dimensions:** Handle 32mm (1.2"), Probe 51mm (2.0").

Specify 8717 for 871. Not available with Type J thermocouple.

# 865, 866/Digital Thermometers

## Thermistor

- Rugged, drop proof, splash proof
- High accuracy
- $-55^{\circ}$  to  $150^{\circ}\text{C}$



Models 865 and 866 are handheld digital thermometers designed to use a thermistor sensor. The 865 reads in Fahrenheit from  $-70^{\circ}\text{F}$  to  $300^{\circ}\text{F}$  with  $0.1^{\circ}$  or  $1^{\circ}$  resolution. The Model 866 reads in Celsius from  $-55^{\circ}\text{C}$  to  $150^{\circ}\text{C}$  with  $0.1^{\circ}$  resolution. Their high accuracy over the environmental temperature range makes these meters especially suited to applications in electronics, life sciences, food processing, and heating and ventilating. The industrial grade construction includes a rugged, high impact ABS plastic case that can withstand a 6 foot drop, and is splash resistant, which makes it suitable for use in harsh environments. The large liquid crystal displays (LCD) make these instruments particularly easy to read. The input connection for each instrument consists of a  $\frac{1}{4}$ " phone jack. The resistance value of the thermistor at  $25^{\circ}\text{C}$  ( $77^{\circ}\text{F}$ ) is  $2252\Omega$ . This is the same thermistor used in all YSI-series 400 probes, allowing compatibility to standard thermistor probes.

A complete line of accessory probes is available for Models 865 and 866. All probes offer the best combination of industrial grade, rugged, user-oriented features, each with stainless steel tips and coiled cable. A strain relief eliminates potential problems with frayed cords. Also available is a cordless general purpose probe which plugs directly into the meter via the  $\frac{1}{4}$ " phone jack.

In addition to probes, other available accessories include the Model 8668 soft carrying case and the Model 8660 tilt stand/belt clip/probe holder. The 8660 allows you to use your thermometer on the bench in a tilt stand, in the field with the belt clip and probe holder, or in the lab at eye level.

Models 865 and 866 are calibrated with NBS traceable equipment. The calibration statement of compliance is included with each instrument.



Model 8660  
(shown with 865  
and probe)

MODEL	RANGE	TEMPERATURE SPAN	RESOLUTION	ACCURACY* (1 YEAR) (18°-28°C)
865	200°F	- 40.0 to + 199.9	0.1°	±(0.3%rdg+0.5°F)
		- 70.0 to - 40.1	0.1°	±(0.3%rdg+1.0°F)
	300°F	- 70 to + 300	1°	±(0.3%rdg+1 °F)
866	150°C	- 40.0 to + 150.0	0.1°	±(0.3%rdg+0.3°C)
		- 55.0 to - 40.1	0.1°	±(0.3%rdg+0.6°C)

**TEMPERATURE SENSOR:** Thermistor (2252Ω @ 25°C).

**ACCURACY\*:** Includes repeatability, temperature coefficient (18° to 28°C), time stability (1 year) and linearization conformity errors. Excludes probe errors; however, probe errors around 0°C may be compensated by an internal adjustment.

**REPEATABILITY:** 0.1°C (0.2°F on 865) typical for 1 week at constant ambient temperature.

**TEMPERATURE COEFFICIENT:** 18° to 28°C: Included in accuracy specification. -10° to 18°C and 28° to 50°C: Less than ±(0.06% rdg + 0.01°C)/°C.

**SENSOR VOLTAGE:** 40mV rms, maximum.

### GENERAL:

**DISPLAY:** 3½-digit LCD, 13mm (0.5") height. Polarity and decimal point indication.

**CONVERSION RATE:** 1.5 readings per second.

**OPEN SENSOR INDICATION:** Display reads between -100.0° and -199.0°.

**OVERRANGE INDICATION:** 3 least significant digits blanked.

**MAXIMUM COMMON MODE VOLTAGE:** 42V peak to earth.

**COMMON MODE REJECTION:** Less than 0.01°F/volt (0.01°C/volt on 866) at DC, 50Hz and 60Hz (2kΩ unbalance, LO driven).

**ENVIRONMENTAL LIMITS (OPERATING):** -10° to 50°C, less than 80% relative humidity up to 35°C; linearly derate 3% RH/°C from 35° to 50°C.

**ENVIRONMENTAL LIMITS (STORAGE):** -35° to 60°C, less than 90% relative humidity up to 35°C; linearly derate 3% RH/°C from 35° to 60°C.

**THERMISTOR LINEARIZATION:** Ratiometric dual-slope A/D with continuous linearization.

**INPUT CONNECTION:** ¼" (6mm) phone jack.

**POWER:** 9V alkaline or carbon-zinc (NEDA 1604) battery.

**BATTERY LIFE, CONTINUOUS:** 350 hours typical with alkaline battery; 200 hours typical with carbon-zinc battery.

**BATTERY INDICATOR:** Display indicates "LO BAT" when less than 10% of life remains.

**DIMENSIONS, WEIGHT:** 160mm long × 69mm wide × 31mm thick (6.5" × 2.4" × 1"). Net weight 210gm (7.5 oz.).

**CONSTRUCTION:** Heavy duty ABS plastic housing.

**ACCESSORIES SUPPLIED:** Battery, instruction manual.

### ACCESSORIES AVAILABLE:

Model 8660: Tilt Stand/Belt Clip/Probe Holder

Model 8662: Encapsulated Thermistor

Model 8663: General Purpose/Immersion Probe

Model 8663A: General Purpose Probe (cordless)

Model 8664: Penetration Probe

Model 8665: Surface Probe

Model 8666: Air/Gas Probe

Model 8668: Soft Carrying Case

### THERMISTOR PROBES

#### SPECIFICATIONS (unless otherwise noted):

**Sensor Type:** NTC (Negative Temperature Coefficient) thermistor.

**Value:** 2252Ω at 25°C.

**Temperature Range:** -55°C to +150°C.

**Tolerance:** ±0.2°C from 0°C to 75°C.

**Dissipation Constant:** 1mW/°C in still air.

**Sheath:** 304 Stainless.

**Connector:** ¼" phone plug, nickel plated brass.

**Base:** Molded high temperature polystyrene, temperature rating 80°C continuous.

**Maximum Tip Temperature:** 150°C continuous.

**Sensor to Sheath Isolation:** Greater than 10MΩ at 150°C at 300V.

**Cable:** Coiled, vinyl clad.

#### MODEL 8662 ENCAPSULATED THERMISTOR

**Application:** General purpose temperature measurements.

**Wire:** Thermoplastic insulated pair, temperature rating 65°C continuous, 80°C momentary.

**Maximum Tip Temperature:** 150°C continuous.

**Time Constant:** 6 seconds (stirred liquids).

#### MODEL 8663 GENERAL PURPOSE/IMMERSION PROBE

**Application:** Liquids and general purpose applications.

**Time Constant:** 3 seconds (stirred liquids).

**Sheath:** 316 stainless.

#### MODEL 8663A GENERAL PURPOSE PROBE

The Model 8663A is a general purpose probe that is inserted directly into the instrument via the ¼" phone jack. The difference between the 8663 and 8663A is that the Model 8663 has a cord that is expandable to 3 feet while the Model 8663A inserts directly into the instrument with no cord.

**Application:** Liquids and general purpose applications.

**Time Constant:** 4 seconds (stirred liquids).

**Sheath:** 316 stainless.

#### MODEL 8664 PENETRATION PROBE

**Application:** Soft and semi-frozen solids.

**Time Constant:** 4 seconds (stirred liquids).

#### MODEL 8665 SURFACE PROBE

**Application:** Flat surfaces of solids.

**Time Constant:** 5 seconds (brass block).

#### MODEL 8666 AIR/GAS PROBE

**Application:** Air and other gases.

**Time Constant:** 5 seconds (5m/sec airflow).

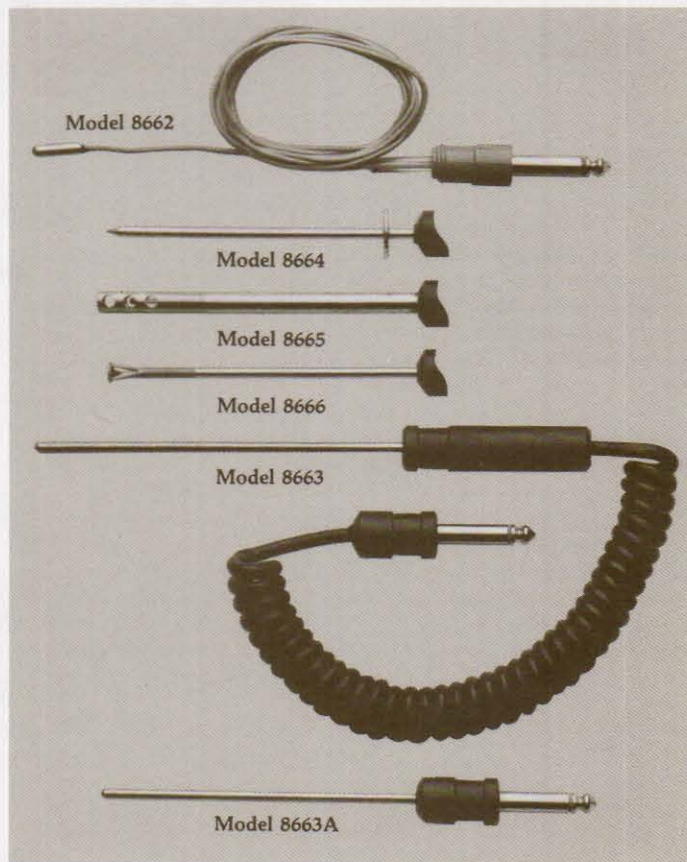

# 868, 869/Digital Thermometers

## Platinum RTD

- Rugged, drop proof, splash proof
- 3 or 4 wire compatible
- High accuracy, wide range



Models 868 and 869 are handheld digital thermometers designed to use 100 $\Omega$  platinum RTD temperature sensors. Model 868 reads in Fahrenheit from  $-360^{\circ}\text{F}$  to  $1100^{\circ}\text{F}$ ; Model 869 reads in Celsius from  $-220^{\circ}\text{C}$  to  $630^{\circ}\text{C}$ . Both have 0.1 $^{\circ}$  resolution to 200 $^{\circ}$ . The instruments are designed for use with probes conforming to the DIN 43 760 standard ( $\alpha = 0.00385$ ).

The platinum RTD sensors of Models 868 and 869 offer excellent repeatability, high accuracy over a wide range, and time stability. They are particularly well suited for petrochemical use and broad research applications, as well as precision process monitoring.

These units are the only 4-wire RTD handhelds on the market. The 3-wire RTDs assume that both main leads and connections have the same resistance. The 4-wire RTD method is preferred for precision laboratory and industrial measurements. Although these units are designed for 4-wire accuracy, they may be used with either 3-wire or 4-wire temperature probes. An internal switch selects the 3-wire or

4-wire mode, and the supplied mating connector can be wired to 3-wire or 4-wire probes. Additionally, the 8691 accessory kit includes adapters for the two most commonly used 3-wire connectors.

A full line of accessory 4-wire probes is available for Models 868 and 869, offering the best combination of industrial grade, user oriented features. The stainless steel probes have large handles, tips designed for specific applications, and strain reliefs to eliminate problems with frayed cords. In addition to probes, other available accessories include the Model 8660 tilt stand/belt clip and the Model 8668 soft carrying case. The 8660 allows you to use your thermometer on the bench in the tilt stand, in the field with the belt clip or in the lab at eye level. The 8668 case will hold the meter with or without the 8660 stand.

Models 868 and 869 are calibrated with NBS traceable equipment. The calibration statement of compliance is included with each instrument.

MODEL	RANGE	TEMPERATURE SPAN	RESOLUTION	4-WIRE ACCURACY* (1 YEAR) (18°-28°C)
868	200°F	-150.0 to + 199.9	0.1°	±0.4°F
	1100°F	-199.9 to - 150.1 -360 to +1100	0.1° 1°	±1 °F ±2 °F
869	200°C	-150.0 to + 199.9	0.1°	±0.3°C
		-199.9 to - 150.1	0.1°	±1.5°C
	630°C	-220 to + 630	1°	±1 °C

**TEMPERATURE SENSOR:** 3-wire or 4-wire 100Ω platinum RTD ( $\alpha=0.00385$ ).

**ACCURACY\*:** Includes DIN 43 760 conformity, repeatability, temperature coefficient (18° to 28°C), time stability (1 year) and errors with up to 50Ω of resistance in each lead. Excludes probe errors; however, probe errors around 0°C may be compensated by an internal adjustment.

**REPEATABILITY:** Less than 0.1°C (0.2°F on 868) typical for 1 week at constant ambient temperature.

**TEMPERATURE COEFFICIENT:** 18° to 28°C: Included in accuracy specification. -10° to 18°C & 28° to 50°C: Less than  $\pm(0.015^\circ\text{C})/^\circ\text{C}$ .

**MAXIMUM LEAD RESISTANCE:** 4-wire: 50Ω max.  
3-wire: 10Ω max.

**SENSOR CURRENT:** 500μA max.

### GENERAL:

**DISPLAY:** 3½-digit LCD, 13mm (0.5") height. Polarity and decimal point indication.

**CONVERSION RATE:** 1.5 readings per second.

**OVERRANGE AND OPEN SENSOR INDICATION:** 3 least significant digits blanked.

### PLATINUM RTD PROBES

**SPECIFICATIONS (unless otherwise noted):**

**Sensor Type:** 100Ω platinum RTD.

**Fundamental Interval:** 38.5Ω.

**Temperature Range:** -70°C to +260°C.

**Tolerance:**  $\pm 0.1\%$  at 0.0°C. Conformance to DIN 43 760 standard.

**Self-Heating:** Less than 0.05°C/mW in stirred water at the ice point.

**Long Term Stability:** Less than  $\pm 0.1\%$  change in  $R_0$  after 10 cycles between -70°C and 260°C and after 2000 hours at 260°C.

**Sheath:** 304 stainless.

**Handle:** Phenolic (100°C continuous).

**Cable:** 4-wire coiled vinyl clad high temperature (80°C continuous).

**Connector:** Switchcraft TA 4F or equivalent.

**Maximum Tip Temperature:** 260°C continuous.

**Sensor to Sheath Isolation:** Greater than 10MΩ at 100°C. Greater than 1MΩ at 260°C.

### MODEL 8693 IMMERSION PROBE

**Temperature Range:** -200°C to +630°C.

**Long Term Stability:** Less than  $\pm 0.1\%$  change in  $R_0$  after 10 cycles between -70°C and 600°C and after 2000 hours at 600°C.

**Sheath:** 316 Stainless

**Maximum Tip Temperature:** 400°C continuous, 630°C momentary.

**Application:** Liquids, gasses, solids.

**Time Constant:** 3 seconds (stirred liquids).

**Minimum Immersion Depth:** 2 inches.

**Sensor to Sheath Isolation:** Greater than 10MΩ at 100°C. Greater than 1MΩ at 600°C.

### MODEL 8695 SURFACE PROBE

**Application:** Flat surfaces or solids.

**Time Constant:** 3 seconds (against aluminum-bronze block).

**MAXIMUM COMMON MODE VOLTAGE:** 42V peak to earth.

**COMMON MODE REJECTION:** Less than 0.001°F/volt (0.001°C/volt on 869) at DC, 50Hz and 60Hz (100Ω unbalance, LO driven).

**ENVIRONMENTAL LIMITS (OPERATING):** -10° to 50°C, less than 80% relative humidity up to 35°C; linearly derate 3% RH/°C from 35° to 50°C.

**ENVIRONMENTAL LIMITS (STORAGE):** -35° to 60°C, less than 90% relative humidity up to 35°C; linearly derate 3% RH/°C from 35° to 60°C.

**RTD LINEARIZATION:** Ratiometric dual-slope A/D with continuous linearization.

**INPUT CONNECTION:** 4-pin miniature instrumentation connector.

**POWER:** 9V alkaline or carbon-zinc (NEDA 1604) battery.

**BATTERY LIFE, CONTINUOUS:** 500 hours typical with alkaline battery; 300 hours typical with carbon-zinc battery.

**BATTERY INDICATOR:** Display indicates "LO BAT" when less than 10% of life remains.

**DIMENSIONS, WEIGHT:** 160mm long × 69mm wide × 31mm thick (6.3" × 2.7" × 1.2"). Net weight 210gm (7.5 oz.).

**CONSTRUCTION:** Heavy duty ABS plastic housing.

**ACCESSORIES SUPPLIED:** Battery, instruction manual, mating input connector.

### ACCESSORIES AVAILABLE:

Model 8660: Tilt Stand/Belt Clip/Probe Holder

Model 8668: Soft Carrying Case

Model 8691: Accessory Kit

Model 8693: General Purpose/Immersion Probe

Model 8695: Surface Probe

Model 8696: Air/Gas Probe

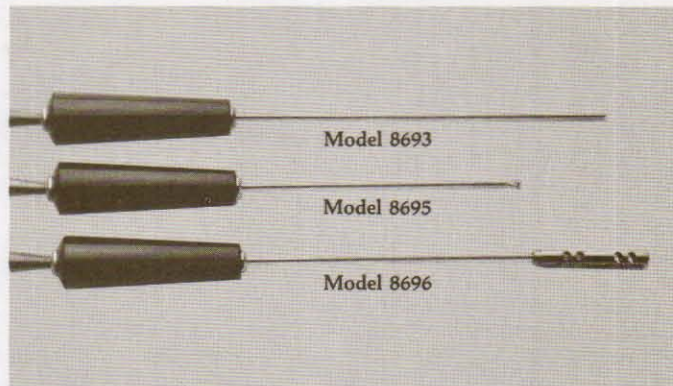

### MODEL 8696 AIR/GAS PROBE

**Application:** Air, gasses.

**Time Constant:** 3 seconds (5m/sec air flow).

### MODEL 8691 ACCESSORY KIT

The Model 8691 Accessory kit includes a mating connector provided with 5 ft. (1.5m) of coiled cable for connection to the user's RTD. Also included are male and female 3-prong "quik" disconnects to enable connecting to the two most commonly used 3-wire probes.

# Selector Guide/Electrometers, Picoammeters

MODEL	FEATURES	INPUT CONNECTION	CURRENT				VOLTAGE			RESISTANCE		CHARGE	
			MEASURES		INPUT CURRENT	RISE TIME	MEASURES		INPUT IMPEDANCE	MEASURES		MEASURES	
			FROM	TO			FROM	TO		FROM	TO	FROM	TO
614	4½ digits. Low cost. Current suppression. Battery powered. Analog output.	TRIAx	10fA	2mA	< 60fA	2.5ms-0.5s	10µV	20V	50TΩ	1Ω	200GΩ	10fC	20nC
619	Dual channel.* Systems. Flexible.	TRIAx	100fA	2A	< 400fA	1-10ms	10µV	200V	20TΩ 20pF	100mΩ	2TΩ	External Capacitor	
642	4½ digits. High sensitivity. BCD, IEEE, battery options.	BNC, GR874®, Special	40aA	100nA	< 50aA	20ms-500ms	20µV	11V	10,000TΩ 2pF	N/A	N/A	800aC	100pC
616	3½ digits. Autoranging. Sensitive. Versatile.	TRIAx	400aA	200mA	< 5fA	50µs-3s	10µV	200V	100TΩ 20pF	1Ω	100TΩ	1fC	10µC
602	Battery power. Analog. Floating input.	TRIAx	1fA	300mA	< 5fA	3ms-2s	10µV	10V	100TΩ 20pF	10Ω	10TΩ	1fC	1µC
610C	Low cost. Analog.	UHF	1fA	300mA	< 5fA	30ms-2s	10µV	100V	100TΩ 20pF	1Ω	100TΩ	1fC	10µC
480	Low cost. Battery option.	BNC	1pA	2mA	< 4pA	1ms-70ms							
427	High speed amplifier.	BNC	3fA	1mA	< 1pA	15µs-330ms							
18000-20	High speed. Programmable.	Microdot	600fA	1mA	< 10pA	200µs-2ms							
26000 Series	Logarithmic.	BNC	10fA	1mA	100fA-1pA	1s-3s							

\*Optional

The "Input Current" above is a DC error current contributed by the electrometer or picoammeter. It tends to be a constant for a particular instrument in a constant environment after warmup. The smallest current that can be detected (listed under "Measures From") indicates the noise current of the instrument.

## Standard Symbols

PREFIXES			QUANTITIES		
SYMBOL	PREFIX	EXPONENT	SYMBOL	UNIT	QUANTITY
a	atto-	10 <sup>-18</sup>	V	volts	EMF
f	femto-	10 <sup>-15</sup>	A	amperes	current
p	pico-	10 <sup>-12</sup>	Ω	ohms	resistance
n	nano-	10 <sup>-9</sup>	C	coulombs	charge
µ	micro-	10 <sup>-6</sup>	s	seconds	time
m	milli-	10 <sup>-3</sup>	W	watts	power
(none)	(none)	10 <sup>0</sup>	F	farads	capacitance
k	kilo-	10 <sup>3</sup>			
M	mega-	10 <sup>6</sup>			
G	giga-	10 <sup>9</sup>			
T	tera-	10 <sup>12</sup>			

Electrometers are high-impedance DC multimeters with very low input current. Digital models operate in a manner similar to DMMs, and are in fact an extension of DMMs into more sensitive current and higher resistance regions. Thus they are useful in situations where current resolution below 1nA, resistance measurement above 200MΩ, or input resistance of 1GΩ or higher is required.

### Model 614: Impressive in a lot of ways

Model 614 is an optimum synthesis of careful design, basic simplicity, quality components and pragmatic performance capabilities. It makes the difficult job of sensitive measurements as easy as operating a DMM, yet it is extremely sensitive and eminently affordable.

### Model 619: Electrometer sensitivity, multimeter ease

Model 619 is designed with full system capabilities in mind. It is optimized to measure V, I and Ω in an automatic system. A dual channel option enables independent measurement of different parameters. Simple front panel controls or bus commands select range, function, zero correction, baseline suppression and filter. Annunciators indicate IEEE-488 interface status.

### Model 642: The most sensitive electrometer

The Model 642 is capable of detecting 10<sup>-17</sup>A. 4½ digits, FET input and modern technology combine to make this a significant improvement over older vibrating reed instruments. IEEE-488 or BCD output, battery adapter and various input connectors are available.

### Model 616: The most versatile electrometer

Model 616 measures current below 1fA, voltage with 100TΩ input resistance up to 200V, 14 decades of resistance, and charge as low as

1fC. Triaxial input and internal shields provide isolation approaching that of battery powered instruments. Its 3½-digit format, with optional interface, makes it suitable for digital data collection.

### Model 610C and Model 602

Both have sensitivity similar to the 616, but are analog instruments. The Model 602 is battery operated and capable of floating up to 1500V. The Model 610C is a line operated instrument.

### Model 480: Lowest cost digital picoammeter

The Model 480 has a 3½-digit display, analog output, and optional IEEE-488 or BCD output or battery pack. It is a professional instrument that is extremely easy to operate. It is also an extremely cost-effective instrument for use in development, research or student laboratory applications.

### Model 427

The Model 427 is a current amplifier with selectable gain, suppression and rise time. Rise time is fast as 15µs (1.5s at 10<sup>11</sup>V/A).

### Model 18000-20

Model 18000-20 is a high speed programmable current amplifier (25mm × 76mm × 127mm) which has 200µs to 2ms rise time. It has 1pA sensitivity, and is designed for digital systems use.

### Model 26000

The Model 26000 series picoammeters are logarithmic instruments covering the ranges of 10pA to 1mA (261XX), 1pA to 100µA (262XX), and 100fA to 100nA (263XX). A 300V bias supply option is also available.



# Electrometers, Picoammeters/Technical Data

## Low current

The goal of any electrical current measurement is to insert an ammeter in the circuit in a way that allows the current measured on the ammeter to be equal to the current originally flowing through the wire. This measurement is carried out to within an acceptable uncertainty, denoted  $U$ . Any ammeter can be modeled as consisting of three separate circuit elements: a shunt resistance  $R_{SH}$  that arises from the cable connected to the meter; a generator of unwanted electrical current  $I_E$ , which represents mainly currents generated by interconnections; and an internal resistance  $R_M$  which includes series cable resistance. The internal resistance is in series with an ideal ammeter  $M_I$  having no resistance or current source of its own.

When the ammeter model is connected in the circuit to be measured, the current indicated on the meter is equal to the current that would flow through the circuit if the ammeter were not inserted, less errors due to elements in the circuit model. These errors consist of currents flowing through the model shunt resistance, currents generated in the interconnections, inherent meter uncertainty, and errors induced by voltage burden (or drop) across the entire ammeter model.

In measurements of "normal" current levels, errors due to the ammeter voltage burden, shunt currents, and noise currents are often

small enough to be ignored. In these cases, the displayed current reading is equal to simply the meter display plus or minus the inherent meter uncertainty,  $U_M$ . Meters designed to measure these normal currents generally consist of a voltmeter circuit that reads a voltage drop across a precision resistor inserted in series with the measured circuit. The reading provided by the voltmeter is thus directly proportional to current flow.

Unfortunately, the voltage burden induced by such meters generally ranges from 200mV to as much as 2V. This voltage drop is enough to cause errors in current measurements below the normal range. To avoid such large voltage drops, picoammeters use negative feedback to a high-gain amplifier followed by a conventional voltage-measuring circuit. The voltage burden of the picoammeter is then equal to the voltage drop of the voltage-measuring circuit divided by the amplifier gain. The resulting voltage burden is small, on the order of 100 $\mu$ V. This low voltage burden reduces both measurement errors and the amount of shunt resistance in the connecting cable that must be maintained to provide a given meter accuracy. Consequently, no special measures need to be taken to obtain high cable resistances. Typical feedback ammeters generally provide sensitivities of 0.001pA to 1pA and accuracy of 0.5% to 3%.

## Sources of Current Measurement Errors

Errors in current-measuring instruments arise from currents flowing through various circuit elements. The current  $I_M$  indicated on a current meter is actually equal to the current  $I_I$  through the meter, plus some meter uncertainty  $U_M$ . The correct equation for indicated current, including error terms, comes from writing a node equation for currents passing through the various elements in the model, then expressing measured current  $I_I$  as  $I_X = (V - V_M)/R_S$ . A similar circuit model gives the location of noise and error currents

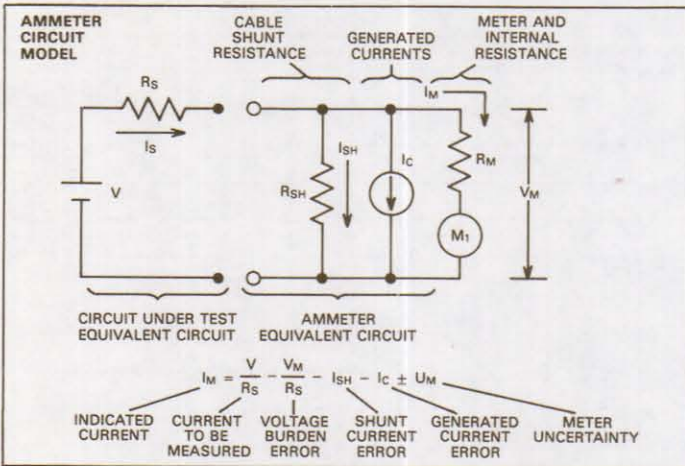

generated during the current measurement. The  $I_{SE}$  current generator represents noise currents generated within the tested circuit itself. These currents could arise due to leakage, piezoelectric or triboelectric effects. Similarly, the  $I_{CE}$  current generator represents currents generated in the interconnection between the current meter and the measured circuit.

The same sources that generate noise currents in the circuit under test may produce noise in the interconnection. Some of the triboelectrically generated currents can be reduced by using low-noise coaxial cable, which contains a conductive coating to reduce friction of the metal/insulator boundary. The  $I_{RE}$  is generated by thermal activity in the shunt resistance. This current is given by  $I_{RE} = (4kTF/R)^{1/2}$  where  $k$  is Boltzmann's constant,  $T$  is temperature in  $^{\circ}$ K,  $F$  is the noise bandwidth and  $R$  is the value of the resistance. Generally, this current can be ignored for measuring currents above  $10^{-14}$ A.

Leakage currents arise when small currents "leak" between voltage sources and nearby current-carrying conductors. When these currents leak into the current path measured by picoammeters, significant errors can result, but metal guards can be used to reduce leakage currents.

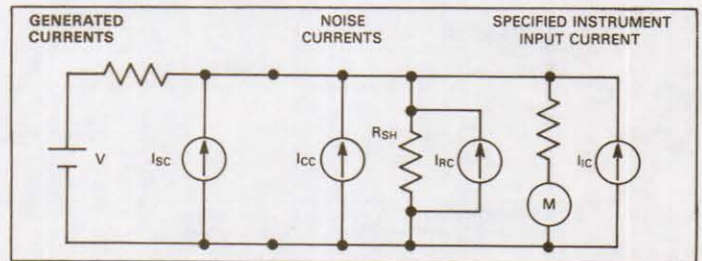

## Guarding

Guarding consists of using a conductor supplied by a low-impedance voltage source to totally surround the leads carrying the high-impedance signals. Maintaining the guard conductor at approximately the same potential as the high impedance circuitry results in drastically reduced leakage currents from those leads.

For example, a coaxial cable with a grounded shield and high voltage applied to the

center conductor from a voltage source with high internal resistance will have a reduced output voltage due to the leakage resistance of the cable. If, instead, the shield is connected to a low-impedance voltage source of approximately the same potential as the high-impedance source, leakage from the center conductor to the shield will all but vanish. Leakage from the outer braid to ground may be considerable, but this flow is of no consequence since the current is supplied by the low impedance source.

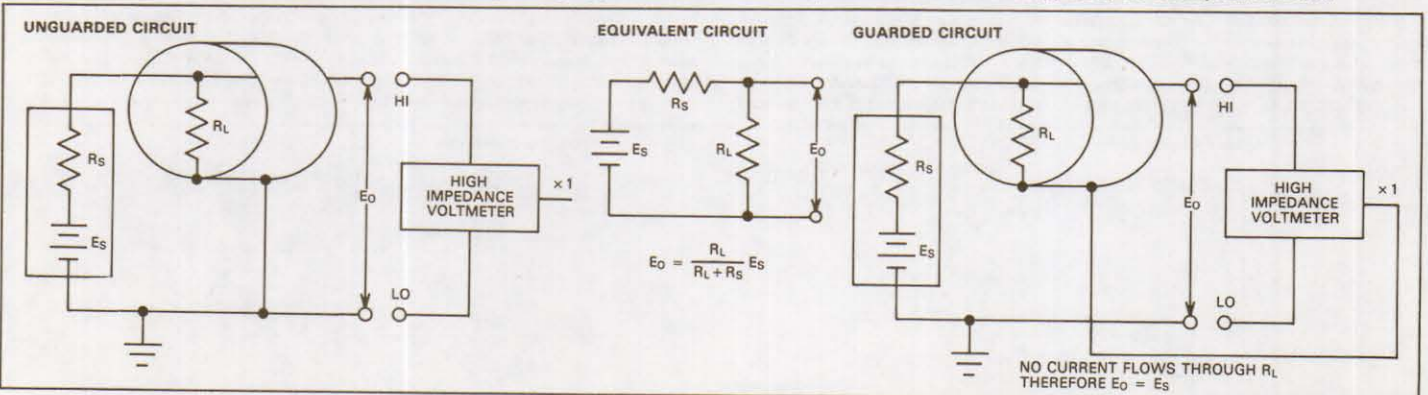

# Technical Data/Electrometers, Picoammeters

## Noise currents

The noise current generator  $I_{CE}$  in the picoammeter model represents currents generated in the connection between the meter and the measured circuit. These currents arise from triboelectric, piezoelectric and electrochemical effects, or resistive leakage.

Triboelectric currents are generated by charges created at the interface between a conductor and an insulator due to friction. Here, free electrons rub off the conductor and create a charge imbalance that causes the current flow. A typical example would be electrical currents generated by insulators and conductors rubbing together in a coaxial cable.

Piezoelectric currents are generated when mechanical stress is applied to certain insulating materials. The effect occurs in ceramics and other crystalline material, as well as some plastics used for insulated terminals and interconnecting hardware.

Noise currents also arise from electrochemical effects when ionic chemicals create weak batteries between two conductors on a circuit board. For example, commonly used epoxy printed circuit boards, when not thoroughly cleaned of etching solution, flux or other material, can generate currents of a few nanoamps between board conductors. To prevent these currents, a cleaning agent such as Freon or methanol should be applied to all interconnecting circuitry. Moisture-resistant coatings applied after cleaning will prevent electrochemical current generation over long time periods.

Finally, high-resistance paths between low-current conductors and nearby voltage sources can generate significant leakage error currents. For example, if a printed-circuit element has a leakage path with a resistance of  $10^9\Omega$  to a nearby 15V supply terminal, a  $15V/10^9\Omega$

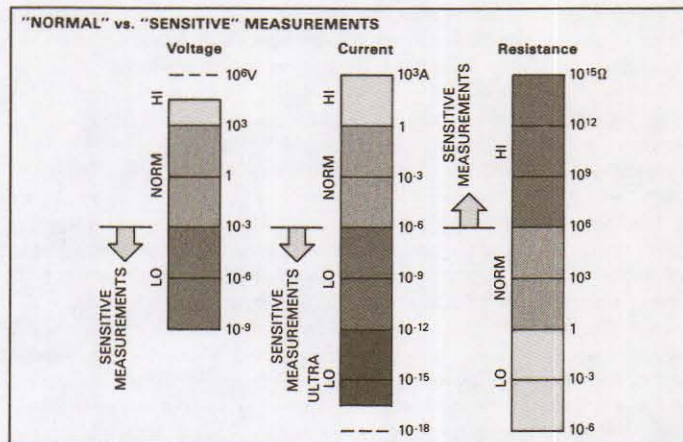

= 15nA noise current exists.

To obtain leakage currents below 10pA, leakage resistance to a 15V supply would have to be above  $1.5 \times 10^{12}\Omega$ . Resistances of this magnitude are difficult to maintain. Consequently, guarding techniques are used to eliminate the need for such stringently held insulation resistance. Here, a metal guard surrounds the input wire to the picoammeter so that leakage currents flow between the voltage source and the grounded metal guard, instead of to the input wire.

One final source of error currents consists of noise generated by any resistor due to thermal activity. This noise current is the theoretical

## TYPICAL MAGNITUDES OF NOISE CURRENT

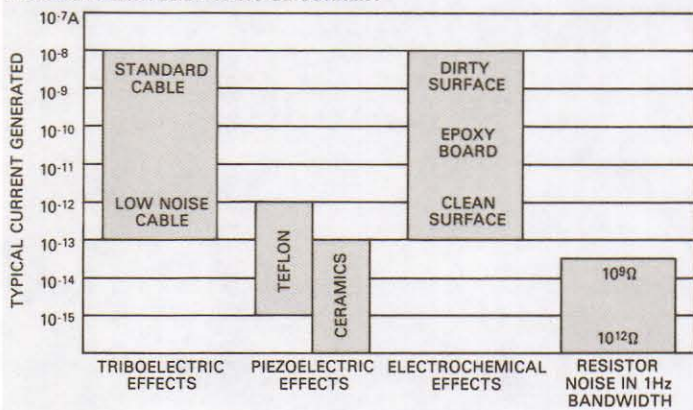

## INSULATION RESISTANCE

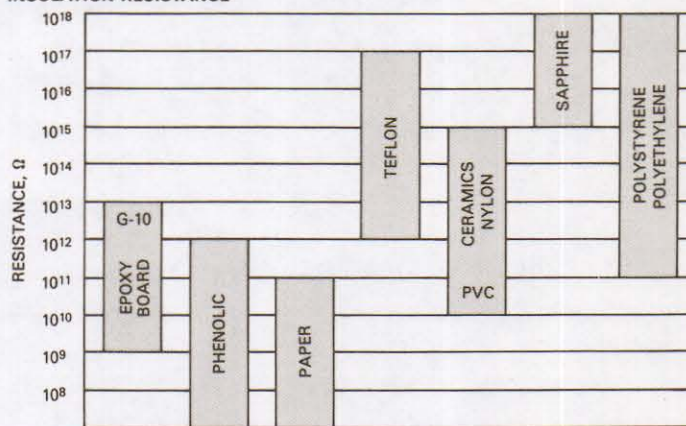

## The difference between normal and low-current instruments.

Conventional ammeters as commonly found in DMMs are usually shunt-type ammeters; a voltmeter reads the voltage across a resistor which is placed in the circuit to be measured. The voltage read is then a measure of current through the resistor. Unfortunately, this method induces large voltage drops of 0.2 to 2V into the measured circuit.

Feedback ammeters are used to measure current in situations where voltage drops are unacceptable, such as in the measurement of very low currents. The voltage drop of these meters is 1mV or less. Feedback ammeters feed the current to be measured to a high-gain amplifier, which drives a voltmeter to give an indication of current.

In this configuration, the magnitude of the voltage drop  $V_M$  induced in the measured

circuit is equal to the voltage drop across the meter  $V_O$  divided by the amplifier gain. Since amplifier gain is large, the resulting  $V_M$  becomes very small.

The error induced by the voltage burden of the current meter may be calculated from the relationships (using a Thevenin equivalent circuit to represent the circuit under test)  $I_S = (V - V_M)/R_S$  and  $I_A = V/R_S$ . The error is  $(I_S - I_A)/I_A$ , which reduces to  $-V_M/V$ .

As an illustration of how this error becomes significant in low-level measurements, consider the measurement of a silicon diode, where the forward voltage drop is 700mV. The error for a conventional DMM whose  $V_M = 200mV$  is  $-200mV/700mV = -28\%$ . In a typical picoammeter whose  $V_M = 1mV$ , error becomes  $-1mV/700mV = -0.14\%$ .

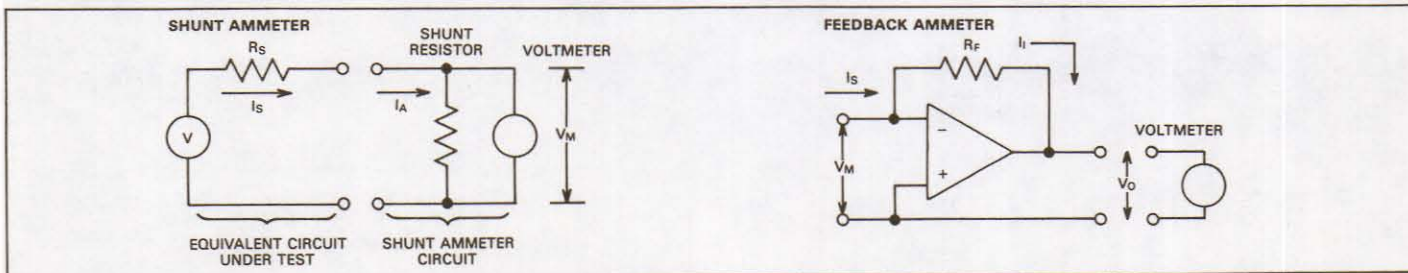

# Electrometers, Picoammeters/Technical Data

## Measuring high resistances.

There are two methods of measuring resistances: the constant voltage method and the constant current method. In the constant voltage method, a constant voltage is impressed across the resistance to be measured, and the resulting current flow is measured to indicate resistance. In the constant current method, a current source is connected to the resistance to be measured; the resulting voltage is measured to indicate resistance.

Electrometers generally employ the constant-current measurement technique. This constant-current technique is often preferred because it requires only one piece of test equipment, whereas constant voltage tests require separate high-accuracy voltage sources and ammeters. Electrometers generally employ an amplifier containing a high input resistance to allow the accurate measurement of high resistances. The factor that usually limits measurement accuracy in these meters is the shunt resistance of the associated cables and noise current generated in the interconnections.

To minimize error currents caused by these shunt resistances, the electrometer amplifier output can be used as a guard connection for insulators connected to the electrometer input. This connection makes the voltage across the input insulators equal to the output voltage divided by amplifier gain. Amplifier gain is very high. Guarding also reduces the input cable capacitance, since this factor is also divided by amplifier gain.

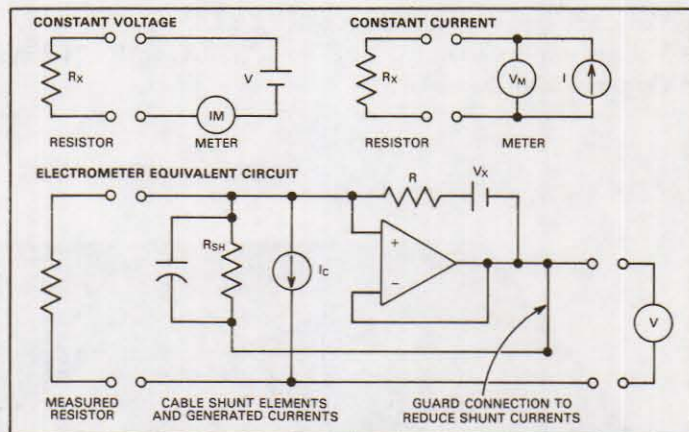

measurement limit for any given temperature and bandwidth. In practice, thermal noise is usually not a limiting factor for measurements of currents above about  $10^{-14}$ A. Since typical picoammeters gauge currents of  $10^{-14}$ A or higher, thermal noise is seldom considered. However, thermal noise may significantly affect measurements of currents  $10^{-15}$ A and lower.

## High resistances

Low current measurement techniques must often be used to determine the value of high resistances. In some cases a constant voltage technique is used. Here, a constant voltage source is impressed across the resistance to be measured, and the resulting current is read from a series ammeter to indicate resistance. This measurement technique provides the advantage of rigidly defining the voltage used in the test. Test voltage is important for some measurements, such as insulation resistance at high voltages. The technique also requires two pieces of test equipment: an accurate, low-noise voltage source and a picoammeter.

A different high-resistance measurement using a constant current impresses current from a constant-current source through the resistance to be measured. The resulting voltage across the resistance is then measured by an electrometer—a high-resistance voltmeter.

This technique is often used for measuring semiconductor I vs. V characteristics and for measuring insulation breakdown voltages at low currents. Typical multifunction electrometers designed for these measurements can measure resistances up to  $2 \times 10^{14}\Omega$ , low currents down to  $10^{-15}$ A, voltages up to 200V across input resistances greater than  $10^{14}\Omega$ , and electronic charges from  $10^{-15}$  to  $10^{-5}$  coulombs.

Typical electrometers directly measure high resistances using an internal constant-current source connected to the input of a high-resistance voltmeter circuit. This configuration eliminates the need for

more than one piece of test equipment, as required by constant-voltage tests.

Electrometers are designed with a high input resistance to allow the accurate measurement of high resistance. Their high input resistance results from the use of a non-inverting amplifier whose effective input resistance is so high that the main factor limiting input resistance is the insulation resistance of mechanical hardware connected to the input, such as input connectors. Input resistances with this configuration can be as high as  $10^{16}\Omega$ . As in the case of low-current measuring instruments, the electrometer circuit model contains a shunt resistance across the input terminals as well as a noise-current generator that represents the sum of all generated currents. The meter uncertainty  $U_M$  is determined by the uncertainty in the amplifier feedback current (due to feedback resistor tolerances) and the amplifier gain. Typical accuracies range from 2% to 5%. Measurement error is limited primarily by the degree to which generated noise current and current through the shunt resistance can be minimized. Thus, the shunt resistance in these meters must be made much greater than the resistance to be measured.

Shunt resistance in high-resistance measurements is determined by the resistance of the cabling and interconnection hardware. The resistance of particular insulators that may contribute to this shunt resistance depends on insulator surface condition, moisture content and temperature. For example, ceramic or glass insulators cleaned with methanol which have not been touched may have  $10^{14}\Omega$  or  $10^{15}\Omega$  resistance. But these same insulators may degrade to  $10^{11}\Omega$  or  $10^{12}\Omega$  if they develop hairline cracks or if they accumulate a surface film such as that acquired from sitting in a dirty atmosphere for months. Absorbed moisture may also change the resistance of certain insulators by orders of magnitude.

To minimize shunt currents, most electrometer amplifiers include a guard connection to their amplifier outputs. This guard connection makes the voltage drop across insulators located between the input and the guard equal to the output voltage divided by the amplifier gain, thus reducing the voltage stress across the insulator to nearly zero. In general, the same techniques used to minimize leakage current in low-current measurements can minimize these same errors in high-resistance measurements.

One additional source of error in high-resistance measurements is parasitic capacitance normally associated with cables and connectors. At high resistance levels, even a few picofarads of capacitance can create appreciable time constants. For example, a  $10^{13}\Omega$  resistance and a cable capacitance of 100pF has an RC time constant of 1000 seconds. However, use of guarding and feedback techniques will reduce this capacitance. Amplifier gain is normally in the range of  $10^4$  to  $10^6$ . The effective input capacitance will be the unfeedback input capacitance divided by this value. With this configuration, most electrometers will tolerate at least 1000pF of source capacity without affecting measurements.

COMMON ELECTRICAL INSULATOR PROPERTIES

MATERIAL	RESISTANCE TO WATER ABSORPTION	MINIMAL PIEZOELECTRIC EFFECTS	MINIMAL TRIBOELECTRIC EFFECTS
Sapphire	+	+	0
Teflon	+	-	-
Polyethylene	0	+	0
Polystyrene	0	0	-
Kel-F	+	0	-
Ceramic	-	0	+
Nylon	-	0	-
Glass Epoxy	-	0	-
PVC	+	0	0
Phenolic	-	+	+

## KEY

- + Material very good in regard to the property
- 0 Material moderately good in regard to the property
- Material weak in regard to the property

# 619/Digital Electrometer

## System/Bench

- Current measurement from 10fA to 2A DC
- Voltage measurement from 1 $\mu$ V to 200V DC with 20T $\Omega$  input resistance
- Optional dual channels

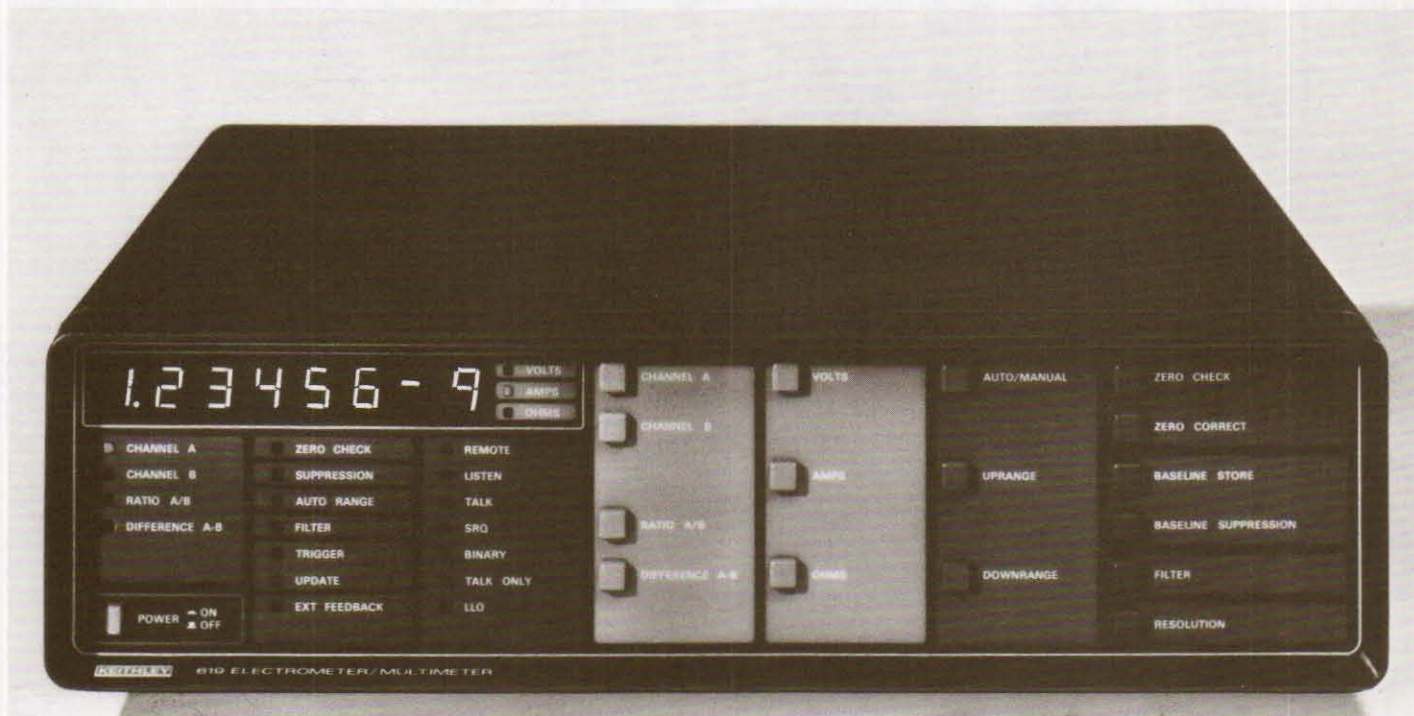

The 619 provides researchers, semiconductor designers and component evaluators with two independent, separately programmable 5½-digit measurement channels, each with 1 $\mu$ V DC, 10fA DC and 10m $\Omega$  sensitivities.

### System compatibility

Keithley designed the 619 to be a convenient and easily reconfigurable System Component:

- Dual channels allow measurements at each node of a device without using switching systems that degrade the signal.
- "External Trigger" initiates a measurement. An "Electrometer Complete" signal is issued at the end of the measurement.
- Data Store capability allows storage of up to 50 readings.

### Guarding and fast sensitive measurements

The 619 uses feedback circuitry pioneered by Keithley for low current measurements. In Amps, the HI input is held within 1mV of circuit LO on the 2nA through 20mA ranges. This provides a convenient GUARD point (circuit LO) and minimizes the charge stored in connecting cables, permitting fast measurements in an automatic system.

### Ratio, Difference

Computes the ratio (A/B) or difference (A-B) of the readings from each channel.

### External Feedback

An "external feedback" range may be selected which permits measurement of charge, logarithmic currents, or provides nonlinear response characteristics.

### Baseline Store, Baseline Suppress

The Baseline Suppress button will modify readings (on any range within that function) by subtracting the stored value.

### Filter

Selection activates a low-pass filter for additional line frequency or noise rejection.

### Digital Self Test

Digital Self Test on power up checks the RAM, ROM, circuit board functionality and opto-isolators.

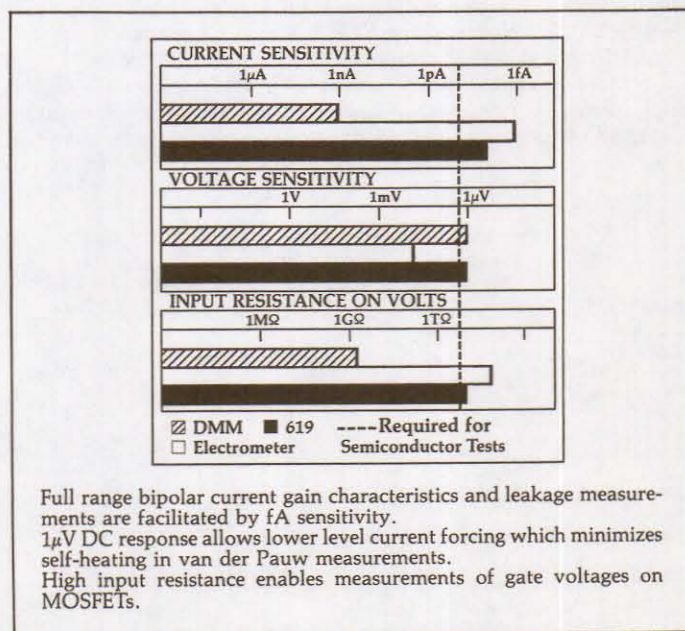

### DC VOLTS

RANGE	MAXIMUM READING	ACCURACY	TEMPERATURE COEFFICIENT
		1 YR., 23° ± 5°C ± (%rdg + counts)	0-18°C & 28-50°C ± (%rdg + counts)/°C
200mV	199,999 × 10 <sup>-3</sup>	0.01% + 25	0.002% + 30
2 V	1.99999	0.01% + 3	0.002% + 3
20 V	19.9999	0.02% + 1	0.002% + 0.3
200 V	199.999	0.02% + 1	0.002% + 0.3

INPUT CAPACITANCE: Less than or equal to 20pF.

INPUT RESISTANCE: Greater than or equal to 20TΩ.

NMRR: Greater than 55dB (greater than 80dB with FILTER).

CMRR: Greater than 100dB (greater than 125dB with FILTER).

ANALOG SETTling TIME (to 0.1% of final value, unfiltered): Less than 5ms.

### DC AMPS

RANGE	MAXIMUM READING	ACCURACY	TEMPERATURE COEFFICIENT	INVERTING FULL SCALE ANALOG OUTPUT
		1 YR., 23° ± 5°C ± (%rdg + counts)	0-18°C & 28-50°C ± (%rdg + counts)/°C	
2 nA	1.99999 × 10 <sup>-9</sup>	0.35% + 65	0.02% + 3	0.2V
20 nA	19.9999 × 10 <sup>-9</sup>	0.35% + 35	0.02% + 3	2.0V
200 nA	199.999 × 10 <sup>-9</sup>	0.15% + 25	0.01% + 30	0.2V
2 μA	1.99999 × 10 <sup>-6</sup>	0.15% + 3	0.01% + 3	2.0V
20 μA	19.9999 × 10 <sup>-6</sup>	0.15% + 25	0.01% + 30	0.2V
200 μA	199.999 × 10 <sup>-6</sup>	0.15% + 3	0.01% + 3	2.0V
2mA	1.99999 × 10 <sup>-3</sup>	0.15% + 25	0.01% + 30	0.2V
20mA	19.9999 × 10 <sup>-3</sup>	0.15% + 3	0.01% + 3	2.0V
2 A	1.99999	0.15% + 25	0.01% + 20	None

INPUT VOLTAGE DROP: Less than 1mV at full-scale except less than 0.6V on 2A range.

ANALOG SETTling TIME (to 0.1% of final value, unfiltered): 2nA through 2μA: 50ms; 20μA through 2A: 5ms.

NMRR: 2nA through 2μA: 70dB; 20μA through 2A: 55dB.

### OHMS

RANGE	MAXIMUM READING	ACCURACY	TEMPERATURE COEFFICIENT	MAXIMUM OPEN-CIRCUIT VOLTAGE
		1 YR., 23° ± 5°C ± (%rdg + counts)	0-18°C & 28-50°C ± (%rdg + counts)/°C	
2 kΩ	1.99999 × 10 <sup>3</sup>	0.2 % + 25	0.01% + 30	5V
20 kΩ	19.9999 × 10 <sup>3</sup>	0.2 % + 3	0.01% + 3	5V
200 kΩ	199.999 × 10 <sup>3</sup>	0.15% + 25	0.01% + 30	5V
2MΩ	1.99999 × 10 <sup>6</sup>	0.15% + 3	0.01% + 3	5V
20MΩ	19.9999 × 10 <sup>6</sup>	0.35% + 25	0.02% + 30	5V
200MΩ	199.999 × 10 <sup>6</sup>	0.35% + 3	0.02% + 3	5V
2 GΩ	1.99999 × 10 <sup>9</sup>	0.35% + 10	0.02% + 0.3	300V
20 GΩ	19.9999 × 10 <sup>9</sup>	1 % + 10	0.15% + 3	300V
200 GΩ	199.999 × 10 <sup>9</sup>	4 % + 10	0.5 % + 0.3	300V
2 TΩ	1.99999 × 10 <sup>12</sup>	10 % + 10	0.5 % + 0.3	300V

OHMS CURRENT SOURCES: 2kΩ, 20kΩ: 100μA.

200kΩ, 2MΩ: 1μA.

20MΩ, 2GΩ: 10nA.

20GΩ through 2TΩ: 100pA.

ANALOG OUTPUT: Analog output voltage level is the product of the Ohms current source and the resistance being measured.

ANALOG SETTling TIMES:

To 0.1% of final value, unfiltered, with less than 100pF input capacitance:

2kΩ through 2MΩ: 5ms.

20MΩ: 20ms.

200MΩ: 200ms.

To 10% of final value, unfiltered, using 6191 Guarded Input Adapter with less than 1pF unguarded input capacitance:

2GΩ: 150ms.

20GΩ: 1.5s.

200GΩ: 15s.

2TΩ: 150s.

### GENERAL

DISPLAY: Numeric; 0.56" LED digits, 4½ digits @6.2 rdg/s (5½ digits @2.4 rdg/s in high resolution mode), decimal point, signed 2-digit exponent.

OVERRANGE INDICATION: Display reads OFLO.

MAXIMUM ALLOWABLE INPUT: 250V rms DC to 60Hz sinewave.

INPUT CURRENT (18°-28°C): Less than 0.4pA.

EXTERNAL TRIGGER: TTL compatible EXTERNAL TRIGGER and ELECTROMETER COMPLETE.

INPUT CONNECTORS (6194 Electrometer rear panel): 2A range: 5-way binding posts. All other functions and ranges via Teflon® insulated triaxial connector.

OUTPUT CONNECTORS: Analog: Amphenol Series 80 (Microphone), 6194 Electrometer rear panel. IEEE: Amphenol or Cinch Series 57, 6193 IEEE-488 Interface rear panel. BNC (chassis isolated) connections for EXTERNAL TRIGGER and ELECTROMETER COMPLETE.

MAXIMUM ALLOWABLE COMMON MODE VOLTAGES:

Input LO (Channel A) to line ground: 250V rms, DC to 60Hz sinewave.

Input LO (Channel B) to line ground: 250V rms, DC to 60Hz sinewave.

Input LO (Channel A) to Input LO (Channel B): 250V rms, DC to 60Hz sinewave.

WARMUP: 1 hour to rated accuracy.

POWER: 90-110, 105-125, 180-220 or 210-250V, 50 or 60Hz (internal switch selected). 75W max., 100V•A max. (internally fan cooled).

ENVIRONMENTAL LIMITS: Operating: 0°-50°C, up to 35°C at 70% non-condensing R.H. Storage: -20°C to 70°C.

DIMENSIONS, WEIGHT: 432mm wide × 127mm high × 406mm deep (17" × 5" × 16"), stackable enclosure. Net weight, 9.8kg (22 lbs.) with Channel B Electrometer module and IEEE-488 Interface module.

ACCESSORIES SUPPLIED: One Model 6194 Electrometer Module and one Model 6011 Input Cable.

ACCESSORIES AVAILABLE:

Model 1019A: Universal Fixed Rack Mounting Kit

Model 1019S: Universal Slide Rack Mounting Kit

Model 6011: Triaxial Input Cable, 1m (3 ft.)

Model 6191: Guarded Input Adapter

Model 6193: IEEE-488 Interface

Model 6194: Electrometer Module

Model 6195: Maintenance Kit

Model 7008-3: IEEE-488 Cable (3 ft.)

Model 7008-6: IEEE-488 Cable (6 ft.)

### READING RATES

Programmed Reading Rate	Number Of Integrations Averaged	Time Per Integration (ms)	Trigger To First Byte (ms)	Readings Per Second
S0	1	4.1	32 (18 binary)	40
S1	1	16.67*	35	21
S2	2	16.67*	80	10
S3	4	16.67*	168	5.4
S4	1	100	120	4.7
S5	2	100	328	2.4
S6	4	100	742	1.2
S7	8	100	1680	0.6
S8	16	100	3360	0.3
S9	32	100	6720	0.15

\*20 @ 50Hz.

### IEEE-488 BUS IMPLEMENTATION

(Requires installation of Model 6193):

Multiline Commands: DCL, LLO, SDC, GET.

Uniline Commands: IFC, REN, EOI, SRQ, ATN. Compatible with IEEE-488-1978 standard.

PROGRAMMABLE PARAMETERS:

Front Panel Controls: Function, Range, Filter, Zero Check, Zero Correct, Baseline Store, Baseline Suppress.

Internal Parameters: SRQ Response, Trigger Modes, Binary or ASCII Data Formats, number of readings to be stored, data terminators, reading rates, integration period.

ADDRESS MODES: TALK ONLY and ADDRESSABLE.

# 642/Digital Electrometer

## Most Sensitive

- $10^{-17}$  A (10aA) sensitivity
- Over 100,000:1 dynamic range at analog output
- Fast response: 22ms time constant on  $10^{-10}$  A range

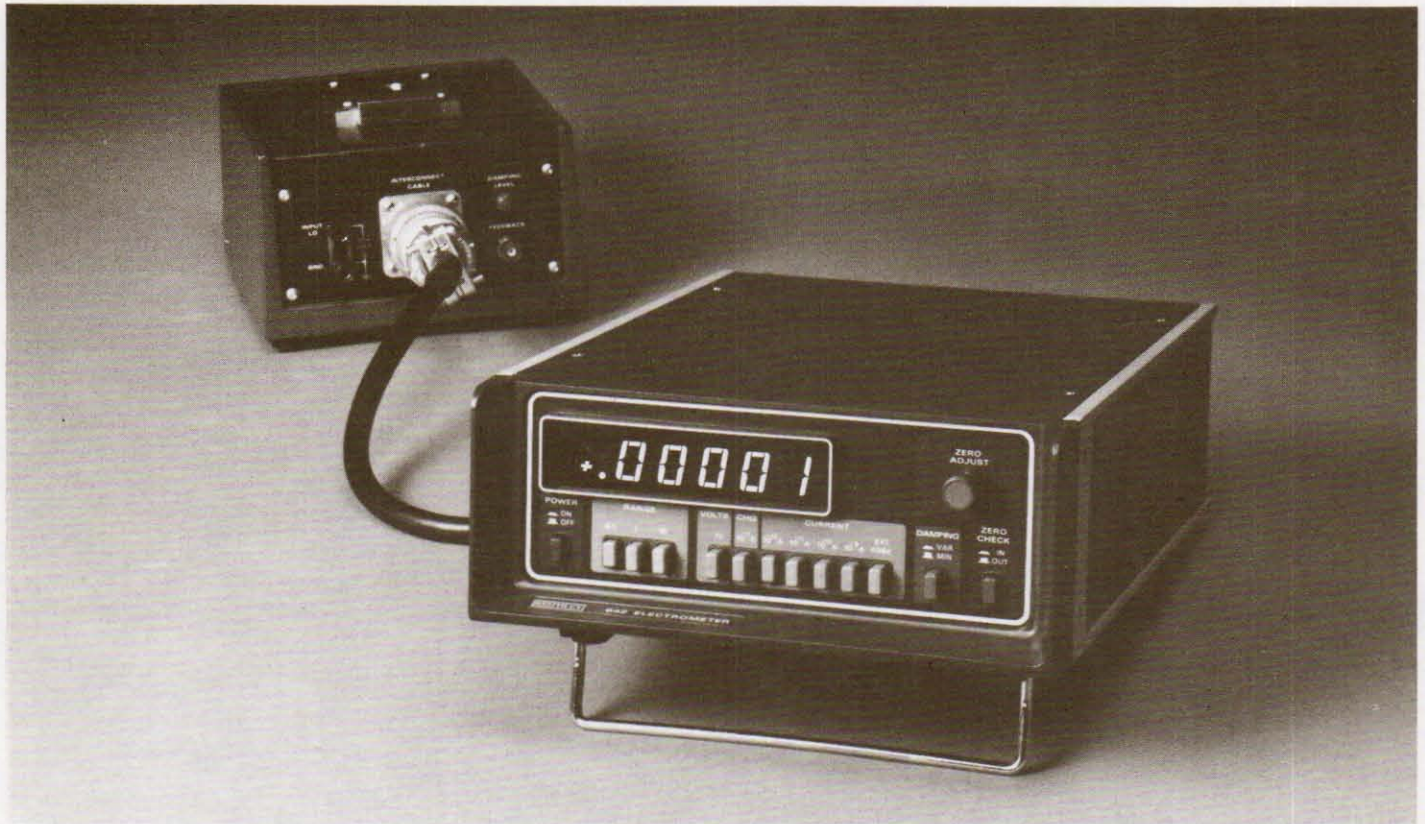

The Keithley 642 is a direct reading MOSFET-based electrometer for sensitive measurement of current, voltage or charge. Its current measurement range is 10aA to 200nA with typically less than 1mV voltage burden. Voltage reading capabilities are  $10\mu\text{V}$  to 10V with  $10,000\text{T}\Omega$  input resistance. Charge can be measured from 800aC to 100pC. Maximum sensitivity is obtained when using the Charge mode to integrate current applied to the input. All functions and ranges are easily selected on the mainframe front panel using color-keyed push-buttons.

### High resolution

The digital format permits observation of small changes in large signals with resolution to 1 part in 20,000 at the digital display. The FEEDBACK output has low noise and non-linearity of only about 5ppm. This wide dynamic range (from noise level to maximum output) provides constant gain over the full span, and eliminates the need for range changing.

### State-of-the-art design

The 642 uses a specially packaged dual monolithic MOSFET with compensated temperature coefficient in a guarded package. Variations in ambient temperature do not cause significant errors because compensation circuitry is individually adjusted for each FET to give a voltage coefficient of only  $30\mu\text{V}/^\circ\text{C}$ .

In the design of the remote head, the active input volume has been minimized. Less than 15 ionization current pulses per hour are observed.

The preamplifier is a direct-coupled circuit with a single, well-controlled time constant. It is a first-order system which produces an exponential response to step inputs. Response time can be varied over a 100:1 span on the  $10^{-12}$  A range.

The remote head is sealed and contains desiccant paper to maintain low internal humidity. The internal humidity can be observed on an indicator located on the bottom of the remote head.

The zero check switching mechanism has been designed for minimum charge transfer, typically less than 10fC. Internal adjustments may be used to further compensate the average charge transfer.

### Analog outputs

Three analog outputs are provided: The FEEDBACK output on the remote head has the widest dynamic range (over  $10^5$ ), lowest noise, and fastest speed.

The 1-VOLT/10,000-COUNT output on the rear of the mainframe normalizes the output to 1V per 10,000 counts regardless of range.

The 1-VOLT/100-COUNT output (also on the rear panel) is useful in sensitive measurements to amplify the signal so that 1V corresponds to 100 counts.

### Accessories

Input connections are described on the Input Connection Chart. In addition, an isolated BCD output option (Model 6422), IEEE-488 interface (Model 6423), 12V battery adapter (Model 6428) and individually sealed desiccant paper refills (Model 6421) are available.

### AS A DC AMMETER

CURRENT SETTING	MAXIMUM READING ON 0.1 RANGE	MAXIMUM READING ON 10 RANGE
10 <sup>-9</sup> A	0.19999 × 10 <sup>-8</sup> A	10.999 × 10 <sup>-9</sup> A
10 <sup>-10</sup> A	0.19999 × 10 <sup>-10</sup> A	10.999 × 10 <sup>-10</sup> A
10 <sup>-11</sup> A	0.19999 × 10 <sup>-11</sup> A	10.999 × 10 <sup>-11</sup> A
10 <sup>-12</sup> A	0.19999 × 10 <sup>-12</sup> A	10.999 × 10 <sup>-12</sup> A

CURRENT SETTING	23°C ±1°C 6-MONTH ACCURACY ±(%rdg + digits)	1% SETTLING TIME ON 10 RANGE AT 1V/10k COUNT ANALOG OUTPUT, AT MINIMUM DAMPING
10 <sup>-9</sup> A	1 % + 3d	≤ 40ms
10 <sup>-8</sup> A	1 % + 3d	≤ 100ms
10 <sup>-11</sup> A	1.3 % + 3d	≤ 400ms
10 <sup>-12</sup> A	1.5 % + 6d	≤ 1 s

NOISE: 4 × 10<sup>-12</sup>A rms (2 × 10<sup>-16</sup>A p-p); less than 15 self-generated alpha pulses per hour.

### AS A DC VOLTMETER

RANGE	MAXIMUM READING	6-MO. ACCURACY 18°C to 28°C (Exclusive of Noise)	1% SETTLING TIME AT 1V/10k COUNT ANALOG OUTPUT
0.1V	.19999	0.05% + 3d	3 s
1 V	1.9999	0.05% + 1d	0.3 s
10 V	10.999	0.05% + 1d	0.03s

NOISE: Less than 20μV rms (100μV p-p).

ZERO STABILITY: 24 hours, ±3°C: ±180μV.

TEMPERATURE COEFFICIENT OUTSIDE OF ±3°C SPAN: ±(30μV + 0.5 digit)/°C.

INPUT RESISTANCE: Greater than or equal to 10<sup>16</sup> Ω.

### AS A COULOMBMETER

RANGES: 10<sup>-11</sup> coulombs, 0.1, 1, or 10 ranges.

INPUT CURRENT (23°C ±1°C): Less than 5 × 10<sup>-17</sup>A.

ACCURACY (23°C ±1°C for 6 months, exclusive of noise): ±(0.3% + 5 digits).

NOISE: 8 × 10<sup>-16</sup> coulombs rms (4 × 10<sup>-15</sup> coulombs p-p), 0.1 range; less than 15 self-generated alpha pulses per hour.

CHARGE ERROR DUE TO ACTUATION OF ZERO CHECK: Typically less than 10<sup>-14</sup> coulombs.

### GENERAL

MAXIMUM INPUTS: Normal or Common Mode: 30V rms DC to 60Hz.  
DISPLAY: Five 0.5 inch LED digits with decimal point and polarity indication.

CONVERSION PERIOD FOR DIGITAL DISPLAY: 400ms.

ANALOG OUTPUTS: Two analog outputs are provided on mainframe rear panel; 1V per 10,000 counts and 1V per 100 counts of the digital display.

POWER REQUIREMENTS:

90V to 110V  
105V to 125V  
180V to 220V  
or 210V to 250V, 50Hz to 60Hz, 30VA max.

DIMENSIONS, WEIGHTS:

MAINFRAME: 3½ in. half rack, overall bench size 100mm high × 217mm wide by 308mm deep (4" × 8½" × 12½"). Net weight 2.9kg (6 lb., 6 oz.).

REMOTE HEAD: 102mm high × 162mm wide × 165mm deep (4" × 6½" × 6½"), exclusive of connectors. Net wt. 0.6kg (9 lb., 2 oz.).

INTERCONNECT CABLE: 4 ft. long. Net wt. 0.6kg (1 lb., 3 oz.).

ACCESSORY SUPPLIED: Four-foot remote head to mainframe interconnect cable.

ACCESSORIES AVAILABLE:

Model 6421: Dessicant Paper Refill

Model 6422: Isolated BCD Output

Model 6423: Isolated IEEE-488 Output

Model 6424: BNC Input Adapter

Model 6425: GR874 Air Line Input Adapter

Model 6426: Sapphire-Insulated Test Box

Model 6427-10: 10-foot Interconnect Cable

Model 6427-50: 50-foot Interconnect Cable

Model 6428: Battery Adapter

Input Connection Chart, showing recommended input connections for various current sensitivities:

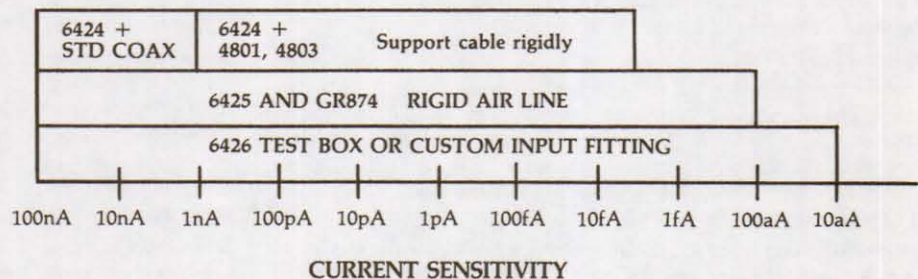

### 642 LNFP

The 642 LNFP is a version of the 642 with improved performance for use with mass spectrometers. A lower noise input stage is combined with faster response on the 10<sup>-11</sup>A range. This provides improved signal-to-noise ratios in mass spectrometer readings.

The fast rise time permits settling to within ±0.01% of the final

value in about 1.5 to 2 seconds. Thus, the precision FEEDBACK output (from the remote head) may be integrated by external equipment for many seconds. This measurement method provides lower noise than that obtained by severely damping the response. Voltage noise is individually documented and is less than 50μV.

# 614/Digital Electrometer

## Economical Sensitivity

- $10^{-14}$ A sensitivity
- Current suppression
- $5 \times 10^{13}\Omega$  input impedance



No single feature can summarize our newest electrometer. Rather, the 614 is an optimum synthesis of careful design, basic simplicity, quality components and pragmatic performance capabilities. It makes the difficult job of sensitive measurements as easy as operating a DMM, yet it is extremely sensitive and eminently affordable.

### Pushbutton easy

The handsome appearance of the 614 is an example of form following function. The pushbutton configuration is precise, simple, quick and easy to use. Color-coded range and function selection is as functional as it is attractive. The front panel is designed to be legible with a large, 4½-digit LED display and clear legends for all functions.

### Battery/line.

For ground isolation from AC line interference, the 614 features a built-in, rechargeable lead-acid battery pack. The pack provides over 10 hours of off-line operation, automatically recharges when the power line is plugged in, and automatically cuts in should line power be interrupted.

### Flexible & convenient

The 614 rear panel includes two analog outputs: a 2V output for

recorders and a preamp output for use as a driven guard with the 6167 guarded input adapter. The Current Suppress feature allows offset currents to be zeroed out at the touch of a button. Durable construction and a full range of capabilities assure a long and cost-effective life cycle replacing a number of delicate, single-function instruments.

### Sensitive performer

The 614 performs four functions: current, resistance, voltage and charge measurement. It is capable of detecting currents as low as  $10^{-14}$ A and resistances up to  $2 \times 10^{11}\Omega$ . It provides more than  $5 \times 10^{13}\Omega$  input impedance on the voltage ranges, and can detect charge over a range of  $10^{-14}$  to  $2 \times 10^{-8}$ C. It is appropriate for a wide range of applications.

### Budgetable

Our optimal design approach to the Model 614 allowed us to reduce production costs without sacrificing the sophisticated performance capabilities traditional with electrometers. The combination of modern assembly techniques, reduced raw material requirements and streamlined circuit boards have helped to keep the cost of the Model 614 extremely low and assure a high return on your investment.



# Digital Electrometer/614

Economical Sensitivity

## VOLTS

RANGE	RESOLUTION	ACCURACY (1 YEAR)		TEMPERATURE
		18°-28°C		COEFFICIENT
		± (%rdg + digits)		0°-18°C & 28°-35°C
				± (%rdg + digits)/°C
0.2V	10 μV	0.08% + 2d <sup>1</sup>		0.005% + 2 d
2 V	100 μV	0.08% + 2d		0.005% + 0.2d
20 V	1mV	0.08% + 1d		0.005% + 0.1d

<sup>1</sup>When properly zeroed.

NMRR: Greater than 60dB at 50Hz and 60Hz.

CMRR: Greater than 120dB at DC, 50Hz and 60Hz.

INPUT IMPEDANCE: Greater than  $5 \times 10^{13} \Omega$  in parallel with 20pF.

MAXIMUM OVERLOAD: 350V peak.

## AMPS

RANGE	RESOLUTION	ACCURACY (1 YEAR)		TEMPERATURE	MAXIMUM SUPPRESSION
		18°-28°C		COEFFICIENT	
		± (%rdg + digits)		0°-18°C & 28°-35°C	
				± (%rdg + digits)/°C	
20pA	10fA	1.5% + 5d <sup>1</sup>		0.1% + 1 d	± 20pA
200pA	100fA	1.5% + 3d		0.1% + 0.3d	± 200pA
2000pA	1pA	1.5% + 1d		0.1% + 0.3d	± 200pA
20nA	10pA	0.5% + 2d		0.02% + 0.3d	± 20nA
200nA	100pA	0.5% + 1d		0.02% + 0.3d	± 200nA
2000nA	1nA	0.5% + 1d		0.02% + 0.3d	± 200nA
20μA	10nA	0.3% + 2d		0.01% + 0.3d	± 20μA
200μA	100nA	0.3% + 1d		0.01% + 0.3d	± 200μA
2000μA	1μA	0.3% + 1d		0.01% + 0.3d	± 200μA

<sup>1</sup>With current suppress.

INPUT BIAS CURRENT: Less than 60fA at 23°C.

INPUT VOLTAGE BURDEN: Less than 200μV.

PREAMP SETTling TIME (to 1% of final value): pA, 0.6s. nA, 5ms. μA, 2.5ms.

NMRR: pA and nA, 70dB. μA, 55dB. At 50Hz and 60Hz.

MAXIMUM OVERLOAD: pA and nA, 350V peak. μA, 75V peak.

## OHMS

RANGE	RESOLUTION	ACCURACY (1 YEAR)		TEMPERATURE	TEST CURRENT
		18°-28°C		COEFFICIENT	
		± (%rdg + digits)		0°-18°C & 28°-35°C	
				± (%rdg + digits)/°C	
2 kΩ	1 Ω	0.5% + 2d		0.03% + 0.3d	100μA
20 kΩ	10 Ω	0.5% + 2d		0.03% + 0.3d	100μA
200 kΩ	100 Ω	0.5% + 2d		0.03% + 0.3d	10μA
2MΩ	1 kΩ	0.8% + 2d		0.04% + 0.3d	100nA
20MΩ	10 kΩ	0.8% + 2d		0.04% + 0.3d	100nA
200MΩ	100 kΩ	0.8% + 2d		0.04% + 0.3d	100nA
2 GΩ	1MΩ	2.0% + 3d		0.12% + 0.3d	100pA
20 GΩ	10MΩ	2.0% + 2d		0.12% + 0.3d	100pA
200 GΩ	100MΩ	2.0% + 2d		0.12% + 0.3d	100pA

MAXIMUM OPEN CIRCUIT VOLTAGE: 32V DC.

MAXIMUM OVERLOAD: kΩ, 75V peak. MΩ, GΩ, 350V peak.

## COULOMBS

RANGE	RESOLUTION	ACCURACY (1 YEAR)	
		18°-28°C	
		± (%rdg + digits)	
0.2nC	10fC	5% + 50d	
2 nC	100fC	5% + 5d	
20 nC	1pC	5% + 1d	

INPUT BIAS CURRENT: Less than 60fA at 23°C.

MAXIMUM OVERLOAD: 350V peak.

## GENERAL

DISPLAY: Five LED digits with appropriate decimal point, polarity and overload indication.

CURRENT SUPPRESS: Active in Current mode; allows correction for input currents on any given range.

CONVERSION TIME: 400ms.

2V ANALOG OUTPUT: 2V out for full range input. Inverting in Voltage and Resistance modes. Output impedance: 10kΩ.

PREAMP OUTPUT: Provides a guard output for Voltage and Resistance measurements. Can be used as an inverting output or with external feedback in Current and Coulombs modes. Output impedance: 1kΩ.

MAXIMUM COMMON MODE VOLTAGE: 500V peak.

CONNECTORS: Input: Triax. Output: 5-way binding posts.

ENVIRONMENT: Operating: 0°C to 35°C up to 70% relative humidity. Storage: -25°C to +65°C.

POWER: Line or battery operated. 105-125V or 210-250V (switch selected), 90-110V available. 50-60Hz, 5VA typical; 18VA maximum during battery charge. 10 hour operation from full charge, 20 hours to recharge.

DIMENSIONS, WEIGHT: 127mm high × 216mm wide × 359mm deep (5" × 8½" × 14⅞"). Net weight 3.3kg (7.2 lbs.).

ACCESSORY SUPPLIED: Model 6011 Triaxial Input Cable.

### ACCESSORIES AVAILABLE:

Model 1019A: Universal Fixed Rack Mounting Kit

Model 1019S: Universal Slide Rack Mounting Kit

Model 6011: Input Cable

Model 6102A: Voltage Divider Probe (up to 200V with 614)

Model 6103C: Voltage Divider Probe (up to 20kV with 614)

Model 6104: Test Shield

Model 6105: Resistivity Chamber

Model 6146: Triax Tee Adapter

Model 6147: Triax to BNC Adapter

Model 6167: Guarded Adapter

# 616/Digital Electrometer

## Autoranging

- Measures V, I, R and Q, and is a current source
- $2 \times 10^{14}\Omega$  input resistance
- $2 \times 10^{-15}\text{A}$  current noise



The 616 is an autoranging digital electrometer with sensitivity to  $10\mu\text{V}/\text{digit}$  and 0.2% voltage accuracy. The easy-to-read  $3\frac{1}{2}$ -digit LED display includes the convenience of automatic polarity and decimal point. The 616 is essentially a digital multimeter optimized for measurements from high source impedance.

The input amplifier provides high input resistance ( $2 \times 10^{14}\Omega$ ), low offset current (less than  $5 \times 10^{-15}\text{A}$ ) and low noise. The double-shielded input section permits floating operations up to  $\pm 1000\text{V}$  above chassis. The Model 616's box-within-a-box construction keeps unshielded capacitance from input HI to chassis ground below 0.1pF, so that CMRR is greater than 140dB with up to  $10^{11}\Omega$  source resistance.

When combined with the optional Model 6162 Isolated Output/Control, the 616 can be used in measurement systems with control of sensitivity as well as digital output data.

### Voltage measurements

As a high input resistance voltmeter, the 616 provides fully automatic ranges from  $\pm 10\text{mV}$  ( $10\mu\text{V}$  sensitivity) to  $\pm 200\text{V}$  DC. Voltage sensitivity can be selected over a range of five decades - automatically, manually or remotely with the optional Model 6162 Isolated Output/Control. With an input resistance greater than  $2 \times 10^{14}\Omega$ , the 616 accurately measures over a wide range of source resistances with negligible loading error. The 616 also provides quick recovery from overloads. Voltage stability is better than  $50\mu\text{V}/^\circ\text{C}$ .

### Current measurements

As a picoammeter, the 616 has ranges from  $10^{-13}\text{A}$  ( $10^{-16}\text{A}$  digital sensitivity) to  $10^{-1}\text{A}$  with 100% overranging. Measurements can be made in either the shunt (normal) mode or the feedback (fast) mode, thus permitting an optimum speed/noise/input voltage tradeoff.

### Resistance measurements

As an ohmmeter, the 616 employs a two terminal, constant current method of resistance measurement to read  $10^3\Omega$  to  $10^{14}\Omega$  full range with 100% overranging. The constant current source may also be used to test semiconductors for breakdown voltage and other I-V characteristics.

### Charge measurements

As a coulombmeter, the 616 measures from  $10^{-5}\text{C}$  to  $10^{-12}\text{C}$  full range with 100% overranging. The instrument can be used for current integration with voltages from  $10\mu\text{V}$  to 200V developed on the integrating capacitor.

### Optional output/control

With the Model 6162 Isolated Output/Control, remote control lines allow selection of measurement sensitivity over five decades, by means of controlling the voltage gain of the amplifier. Individual strobe lines permit data transfer using a minimum of four control lines (bit-parallel, character serial output). The 6162 outputs are fully isolated, providing complete data, timing outputs and multiple strobe lines. The open-collector BCD outputs are compatible with most TTL and DTL logic.

### AS AN AUTORANGING VOLTMETER

**RANGE:**  $\pm 10\mu\text{V}$  per digit (10mV full range) to  $\pm 100\text{V}$  full range in five decade ranges. 100% overranging to 1999 on all ranges.

**ACCURACY (18°C to 28°C):**  $\pm(0.2\%$  of reading + 0.1% of range).

**READING TIME:** Less than 4 seconds to within 0.1% of final reading, except where limited by source characteristics.

**ZERO DRIFT:** Less than ( $50\mu\text{V}$  + 0.01% of range) per °C, and less than  $100\mu\text{V}$  per 24-hour period after two hours warmup.

**NOISE:**  $\pm 10\mu\text{V}$  with input shorted.

**INPUT IMPEDANCE:** Greater than  $2 \times 10^{14}\Omega$  shunted by 20pF. Input resistance may be selected in decade steps from 10 to  $10^{11}\Omega$ .

#### NORMAL MODE REJECTION RATIO

RANGE	NMRR	MAXIMUM AC
10mV	94dB	2V p-p
100mV	80dB	2V p-p
1 V	80dB	20V p-p
10 V	60dB	20V p-p
100 V	60dB	200V p-p

For voltage of line frequency and at least 10% of full range DC reading. Maximum total input 200V peak AC & DC.

**COMMON MODE REJECTION RATIO:** Greater than 140dB at line frequency with 300V peak-to-peak from LO to ground, up to  $10^{11}\Omega$  source resistance, and at least 10% of full range DC reading.

### AS AN AMMETER

**RANGE:**  $\pm 10^{-16}\text{A}$  per digit ( $10^{-13}\text{A}$  full range) to  $\pm 0.1\text{A}$  full range in 13 decade ranges. 100% overranging to 1999 on all ranges.

**ACCURACY (18°C to 28°C):**

RANGE SWITCH SETTING	ACCURACY
$10^{-1}$ to $10^{-7}\text{A}$	$\pm(0.5\%$ of reading + 0.1% of range)
$10^{-8}\text{A}$	$\pm(2\%$ of reading + 0.1% of range)
$10^{-9}$ to $10^{-11}\text{A}$	$\pm(5\%$ of reading + 0.1% of range)

**NOISE:**  $2 \times 10^{-15}\text{A}$  peak-to-peak on the most sensitive range, exclusive of alpha particle disturbance.

**OFFSET CURRENT:** Less than  $5 \times 10^{-15}\text{A}$ .

**COMMON MODE REJECTION:** 300V peak-to-peak at line frequency from circuit LO to chassis ground on any range and with at least 10% of full range DC reading will not degrade accuracy more than 0.3% of range. (Equivalent to 140dB CMRR.)

### AS AN OHMMETER

**RANGE:**  $1\Omega$  per digit (1000 $\Omega$  full range) to  $10^{14}\Omega$  full range in 12 decade ranges. 100% overranging to 1999 on all ranges.

**ACCURACY (18°C to 28°C):**

RANGE SWITCH SETTING	ACCURACY
$10^5$ to $10^7$	$\pm(0.5\%$ of reading + 0.1% of range)
$10^8\Omega$	$\pm(2\%$ of reading + 0.1% of range)
$10^9$ to $10^{12}\Omega$	$\pm(5\%$ of reading + 0.1% of range)

**METHOD:** Two-terminal constant-current. Current equals reciprocal of Ohms range.

### AS A COULOMB METER

**RANGE:**  $\pm 10^{-15}\text{C}$  per digit ( $10^{-12}\text{C}$  full range) to  $\pm 10^{-5}\text{C}$  full range in 8 decade ranges. 100% overranging to 1999 on all ranges.

**ACCURACY (18°C to 28°C):**  $\pm(5\%$  of reading + 0.1% of range).

### AS A CONSTANT CURRENT SOURCE

**RANGE:** 8 currents in decade steps from  $10^{-5}$  to  $10^{-12}\text{A}$  using Ohms ranges. HI terminal is positive.

**COMPLIANCE:** Up to 200V.

**ACCURACY (18°C to 28°C):**  $\pm 0.5\%$  from  $10^{-5}$  to  $10^{-7}\text{A}$ .  $\pm 2\%$  at  $10^{-8}\text{A}$ .  $\pm 5\%$  from  $10^{-9}$  to  $10^{-12}\text{A}$ .

**LOAD REGULATION:** Better than 0.1% for loads up to  $10^{11}\Omega$ .

### GENERAL

**DISPLAY:** 3 digits plus 1 overrange digit; decimal position, polarity and overload indication; 5 readings per second. Depending on sensitivity setting, 3 least-significant digits blink or blank when overload condition exists.

**POLARITY SELECTION:** Automatic.

**SENSITIVITY SELECTION: Automatic:** Voltage sensitivity selection is fully automatic. Sensitivity selection is automatic two decades above and below range switch setting for resistance, charge and most current measurements. **Manual:** Front panel switch. **Remote:** Programmable with the Model 6162 Output/Control (optional).

**ISOLATION:** Circuit LO to chassis ground greater than  $10^9\Omega$  shunted by 500pF (decreasing to  $10^8\Omega$  at 30°C and 70% relative humidity). Circuit LO may be floated up to  $\pm 1000\text{V}$  with respect to chassis ground.

**ANALOG OUTPUTS: Unity Gain:** For DC inputs, output is equal to input within 20ppm for output currents of 1mA or less. In the fast mode, output polarity is opposite input polarity. **1V:**  $\pm 1\text{V}$  at up to 1mA with respect to circuit LO for full range input; 100% overrange capability. In the normal mode, the output polarity is opposite input polarity.

**OPERATING ENVIRONMENT:** 18°C to 28°C, 0% to 70% relative humidity. 10°C to 50°C with derated specifications. **Storage:** 0°C to 70°C.

**CONNECTORS: Input:** Teflon-insulated triaxial. **Analog Outputs:** Unity gain, 1V, chassis, LO and guard; binding posts. **BCD Output:** Internal connectors for interfacing the Model 6162 Isolated Output/Control.

**DIMENSIONS, WEIGHT:** Style M, 90mm (3½") half-rack, overall bench size 100mm high  $\times$  220mm wide  $\times$  400mm deep (4"  $\times$  8¾"  $\times$  15¾"). Net weight, 4.8kg (11 lbs.).

**POWER:** Line operation: 90-125 or 180-250V (switch selected), 50-60 Hz, 9W.

**ACCESSORY SUPPLIED:** Model 6011 Input Cable: 1m (3 ft.) triaxial cable with triaxial connector and 3 alligator clips.

### SPECIFICATIONS/6162

**DIGITAL OUTPUT: BCD (8421)** open collector logic represents each of 3 digits (0 = "0000"), overrange digit, uprange ("0"), polarity (+ = "1"), decimal position (5 lines), exponent (5 line, BCD), exponent polarity (+ = "1"), downrange ("0"), zero check ("1"), and function (2 bit code).

**ACCURACY:**  $\pm 1$  digit with respect to 616 display.

**FLAG (FLAG):** Logic "1" ("0") from 50ms to 7 seconds depending on Print Rate setting. No change in digital output is made during this interval.

**OUTPUT LOGIC LEVELS:** Output Logic "1"  $\equiv$  open collector to output LO. Output Logic "0"  $\equiv$  closure to output LO. Output Device MC858P or equivalent (greater than 6V breakdown, 0.5V at +35mA sink).

**REMOTE CONTROLS:**

**Zero Check:** Logic "0" actuates 616 Zero Check.

**Sensitivity:** 4-line code for remote sensitivity setting of 616.

**Display Hold:** Logic "0" retains last reading on display (except polarity).

**Output Hold:** Logic "0" retains data from last reading.

**Strobe:** 8 lines for serializing in multiples of 4 bits. Logic "1" inhibits controlled output lines.

**CONTROL LOGIC LEVELS:** Logic "1"  $\equiv$  either an open circuit or a voltage between +2 and +12V referenced to output LO. Logic "0"  $\equiv$  closure to output LO within 0.5V while sinking 2.5mA.

**PRINT RATE:** Variable via front panel control from ½ second per reading to 7 seconds per reading in ½ second increments.

**ISOLATION:** Input LO to output LO: sufficient to maintain 616 isolation specifications except adds 200pF capacitance. Output LO to ground: greater than  $10^8\Omega$  shunted by 0.1 $\mu\text{F}$ . Output LO may be floated up to  $\pm 100\text{V}$  with respect to ground.

**CONNECTORS: Input:** Attached cable connects to 616. **Output:** 50-pin AMP type 205211-1. Mating connector supplied.

**ENVIRONMENT: Operating:** 10°C to 50°C, 0% to 70% relative humidity. **Storage:** 0°C to 70°C.

**POWER:** 90-125 or 180-250V (switch selected), 50-60Hz, 9W.

**DIMENSIONS, WEIGHT:** Style M, 90mm (3½") half-rack, overall bench size 100mm high  $\times$  220mm wide  $\times$  400mm deep (4"  $\times$  8¾"  $\times$  15¾"). Net weight, 3.2kg (7 lbs.).

**ACCESSORY SUPPLIED:** Model 1007 Dual Rack Mounting Kit.

# 602/Electrometer

## Floating

- Battery operated: 1000 hours life
- $3 \times 10^{-15}$ A current noise
- 1500V floating capability

This battery-operated solid state electrometer measures voltage, amperes, ohms and coulombs with sensitivity equal to line-operated electrometers. Battery operation permits complete isolation from line and fast warm-up.

For off-ground operation, the 602 provides user safety by maintaining the case at ground potential with up to 1500V applied to the LO terminal of the input. It also allows complete guarding of the HI terminal to increase effective input resistance or decrease effective input capacitance.

Input current is  $5 \times 10^{-15}$ A. Current ranges extend from  $10^{-14}$ A to 0.3A full scale.

Voltage may be measured from 1mV full scale with  $10^{14}\Omega$  input resistance.

Resistance up to  $10^{13}\Omega$  may be measured using the constant current source method, which may also be used for determining semiconductor I-V characteristics.

Charge may be measured from  $10^{-15}$ C to  $10^{-6}$ C. The 1000-hour battery life makes the 602 particularly valuable for remote monitoring of background radiation levels.

The high gain amplifier may be used as a high impedance unity gain buffer with less than 10ppm error.

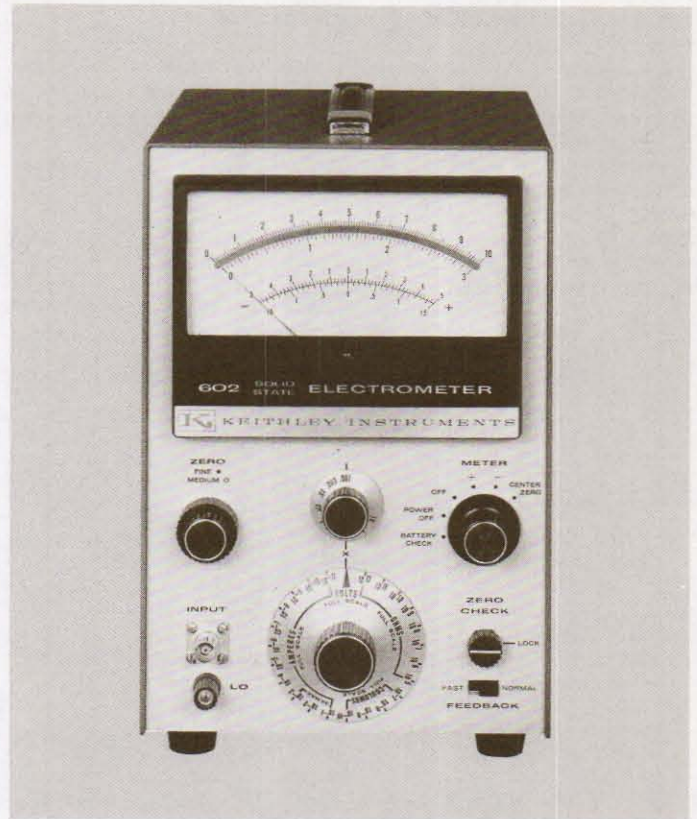

### AS A VOLTMETER

**RANGE:** 0.001V full scale to 10V in nine 1× and 3× ranges.

**ACCURACY:**  $\pm 1\%$  of full scale on all ranges, exclusive of noise and drift.

**ZERO DRIFT:** Less than 1mV per 24 hours; less than  $150\mu\text{V}$  per  $^{\circ}\text{C}$ .

**METER NOISE:**  $\pm 25\text{mV}$  maximum with input shorted on most sensitive range.

**INPUT IMPEDANCE:** Greater than  $10^{14}\Omega$  shunted by 20pF. Input resistance may also be selected in decade steps from 10 to  $10^{11}\Omega$ .

### AS AN AMMETER

**RANGE:**  $10^{-14}$ A full scale to 0.3A in twenty-eight 1× and 3× ranges.

**ACCURACY:**  $\pm 2\%$  of full scale on 0.3 to  $10^{-11}$ A ranges using the smallest available multiplier setting;  $\pm 4\%$  of full scale on  $3 \times 10^{-12}$  to  $10^{-14}$ A ranges.

**METER NOISE:** Less than  $\pm 3 \times 10^{-15}$ A.

**OFFSET CURRENT:** Less than  $5 \times 10^{-15}$ A.

### AS AN AMPLIFIER

**INPUT IMPEDANCE:** Greater than  $10^{14}\Omega$  shunted by 20pF. Input resistance may also be selected in decade steps from 10 to  $10^{11}\Omega$ .

**OUTPUTS:** Unity gain output and either voltage or current recorder output.

**UNITY GAIN OUTPUT:** At DC, output is equal to input within 10 ppm, exclusive of noise and drift, for output currents of  $100\mu\text{A}$  or less. Up to 1mA may be drawn for input voltages of 10V or less. Output polarity is the same as input polarity.

**VOLTAGE RECORDER OUTPUT:**  $\pm 1\text{V}$  for full-scale input. Internal resistance is  $910\Omega$ . Output polarity is opposite input polarity.

**Gain:** 0.1, 0.33, etc. to 1000.

**Frequency Response (within 3dB):** DC to 40kHz at a gain of 1 and lower, decreasing to DC to 100Hz at maximum gain. Full output response limited to 3kHz on any gain.

**Noise:** Less than 3% rms of full scale at gain of 1000, decreasing to less than 0.5% at gains below 10.

**CURRENT RECORDER OUTPUT:**  $\pm 1\text{mA}$  for full scale input, variable  $\pm 5\%$  with  $1400\Omega$  recorders.

### AS AN OHMMETER

**RANGE:**  $100\Omega$  full scale to  $10^{13}\Omega$  in twenty-three linear 1× and 3× ranges.

**ACCURACY:**  $\pm 3\%$  of full scale on 100 to  $10^6\Omega$  ranges using the largest available multiplier setting; 5% of full scale on  $3 \times 10^9$  to  $10^{13}\Omega$  ranges.

### AS A COULOMB METER

**RANGE:**  $10^{-15}$ C full scale to  $10^{-6}$ C in fifteen 1× and 3× ranges.

**ACCURACY:**  $\pm 5\%$  of full scale on all ranges. Drift due to offset current does not exceed  $5 \times 10^{-15}$ C per second.

### GENERAL

**POLARITY:** Meter switch selects left-zero (positive or negative) or center-zero scales. Output polarity is not reversed.

#### CONNECTORS:

**Input:** Teflon-insulated triaxial.

**LO:** Binding post.

**Voltage or current output:** Amphenol 80-PC2F.

**Unity gain output, chassis ground:** Binding posts.

**POWER:** Six 2N6 (or 246, VS305, NEDA 1602); one RM-1W. 1000 hours battery life. Condition of all batteries may be checked with front panel controls.

**ISOLATION:** Circuit ground to chassis ground: Greater than  $10^9\Omega$  shunted by  $0.0015\mu\text{F}$ . Circuit ground may be floated up to  $\pm 1500\text{V}$  with respect to chassis ground.

**DIMENSIONS, WEIGHT:** Overall bench size 275mm high  $\times$  175mm wide  $\times$  290mm deep ( $10\frac{3}{4}'' \times 7'' \times 11\frac{1}{2}''$ ). Net weight, 5.7kg (13 lbs.).

**ACCESSORIES SUPPLIED:** Model 6011 Input Cable: 1m (36'') triaxial cable with triaxial connector and 3 alligator clips. Mating output connector.

- $10^{-15}$ A input current
- $10^{14}\Omega$  input resistance to 100V
- Measures V, I, R, Q, and is a current source

The 610 series of electrometers was introduced by Keithley more than 25 years ago. Thousands of laboratories have used this series of electrometers as the standard "work-horse" for sensitive measurements.

The 610C is a low cost solid state electrometer which indicates from 1mV full scale to 100V, and has an input resistance of  $10^{14}\Omega$ . Variable gain and unity-gain outputs make the meter useful as a high impedance amplifier.

For current measurements, the 610C displays from  $10^{-14}$ A full scale to 0.3A. Input current is  $5 \times 10^{-15}$ A.

Two modes of operation are available for low current measurements: a FAST mode, which has high speed and low input voltage drop, and a NORMAL mode, which tends to have lower noise, and may be used with high source capacitance.

The 610C also measures resistances to  $10^{14}\Omega$  and may be used as a current source in the resistance mode.

Charge measuring capability extends from  $10^{-15}$ C to  $10^{-5}$ C.



### AS A VOLTMETER

**RANGE:** 0.001V full scale to 100V in eleven  $1\times$  and  $3\times$  ranges.  
**ACCURACY:**  $\pm 1\%$  of full scale on all ranges, exclusive of noise and drift.  
**ZERO DRIFT:** Less than 1mV per 24 hours; less than  $150\mu\text{V}$  per  $^{\circ}\text{C}$ .  
**METER NOISE:**  $\pm 25\mu\text{V}$  maximum with input shorted on most sensitive range.

**INPUT IMPEDANCE:** Greater than  $10^{14}\Omega$  shunted by 20pF. Input resistance may also be selected in decade steps from 10 to  $10^{13}\Omega$ .

### AS AN AMMETER

**RANGE:**  $10^{-14}$ A full scale to 0.3A in twenty-eight  $1\times$  and  $3\times$  ranges.  
**ACCURACY:**  $\pm 2\%$  of full scale on 0.3 to  $10^{-11}$ A ranges using the smallest available multiplier setting;  $\pm 4\%$  of full scale on  $3 \times 10^{-12}$  to  $10^{-14}$ A ranges.

**METER NOISE:** Less than  $\pm 3 \times 10^{-15}$ A.

**OFFSET CURRENT:** Less than  $5 \times 10^{-15}$ A.

### AS AN AMPLIFIER

**INPUT IMPEDANCE:** Greater than  $10^{14}\Omega$  shunted by 20pF. Input resistance may also be selected in decade steps from 10 to  $10^{13}\Omega$ .

**OUTPUTS:** Unity gain output and either voltage or current recorder output.

**UNITY GAIN OUTPUT:** At DC, output is equal to input within 10 ppm, exclusive of noise and drift, for output currents of  $100\mu\text{A}$  or less. Up to 1mA may be drawn for input voltages of 10V or less. Output polarity is the same as input polarity.

**VOLTAGE RECORDER OUTPUT:**  $\pm 3\text{V}$  for full-scale input. Internal resistance is  $3\text{k}\Omega$ . Output polarity is opposite input polarity.

Gain: 0.03, 0.1 to 3000.

**Frequency Response (within 3dB):** DC to 40kHz at a gain of 1 and lower, decreasing to DC to 100Hz at maximum gain.

**Noise:** Less than 3% rms of full scale at gain of 3000.

**CURRENT RECORDER OUTPUT:**  $\pm 1\text{mA}$  for full-scale input, variable  $\pm 5\%$  with  $1400\Omega$  recorders.

### AS AN OHMMETER

**RANGE:**  $100\Omega$  full scale to  $10^{14}\Omega$  in twenty-five linear  $1\times$  and  $3\times$  ranges.  
**ACCURACY:**  $\pm 3\%$  of full scale on 100 to  $10^9\Omega$  ranges using the largest available multiplier setting; 5% of full scale on  $3 \times 10^{10}$  to  $10^{14}\Omega$  ranges.

### AS A COULOMB METER

**RANGE:**  $10^{-13}\text{C}$  full scale to  $10^{-5}\text{C}$  in seventeen  $1\times$  and  $3\times$  ranges.  
**ACCURACY:**  $\pm 5\%$  of full scale on all ranges. Drift due to offset current does not exceed  $5 \times 10^{-15}\text{C}$  per second.

### GENERAL

**POLARITY:** Meter switch selects left-zero (positive or negative) or center-zero scales. Output polarity is not reversed.

#### CONNECTORS:

**Input:** Teflon-insulated UHF type; ground binding post.

**Voltage or current output:** Amphenol 80-PC2F.

**Unity gain output:** Binding posts.

**POWER:** 105-125 or 210-250V (switch selected), 50-60Hz, 10W.

**LINE STABILITY:** A 10% change in line voltage will cause less than a  $10\mu\text{V}$  meter deflection on all ranges.

**DIMENSIONS, WEIGHT:** (Model 610C): Overall bench size 275mm high  $\times$  175mm wide  $\times$  290mm deep ( $10\frac{3}{4}'' \times 7'' \times 11\frac{1}{2}''$ ). Net weight, 4.8kg (11 lbs.). (Model 610CR): Standard 135mm  $\times$  485mm rack mounting, 280mm (11") depth behind front panel. Net weight, 5.4kg (12 lbs.).

**ACCESSORIES SUPPLIED:** Mating input, output connectors and binding post adapter.

# 427/Current Amplifier

## Current Amplifier

- High speed - as fast as  $15\mu\text{s}$
- Current suppression
- Low noise

The Keithley Model 427 Amplifier provides high speed combined with low noise and selectable gain, current suppression and rise time.

It is the fastest Keithley picoammeter, with rise times as fast as  $15\mu\text{s}$  at  $10^{-8}\text{V/A}$  gain. Rise times as fast as 1.5ms at the maximum gain of  $10^{11}\text{V/A}$  may be selected.

By selecting slower rise times, wider dynamic range and lower noise are obtained: at  $10^{11}\text{V/A}$  gain, noise of  $3 \times 10^{-15}\text{A rms}$  is achieved, with a dynamic range of 13,000:1.

The built-in current suppression with 10-turn resolution permits compensation of large steady-state currents to observe small changes on a more sensitive range. Eight decade ranges of current suppression are provided, from  $10^{-10}$  to  $10^{-3}\text{A}$ .

Transient overloads up to 1000V are absorbed without damage, and to prevent unrecognized distortion, the 427 gives visible indication of all overloads.

These features, plus the its combination of speed, dynamic range and sensitivity, make the 427 an extremely useful instrument with scanning electron microscopes, sensitive spectrum analyzers, mass spectrometers and photomultiplier systems. It is also widely used for measurement of photo effects in biological systems and membrane



transport studies, as well as measurement of beam currents and semiconductor properties.

**RANGE:**  $10^4$  to  $10^{11}\text{V/A}$  in eight decade ranges. ( $10^{-13}\text{A}$  resolution to  $10^{-3}\text{A}$  full output.)

**OUTPUT:**  $\pm 10\text{V}$  at up to 3mA.

**OUTPUT RESISTANCE:** Less than  $10\Omega$  DC to 30kHz.

**OUTPUT ACCURACY:**  $\pm 2\%$  reading up to  $10^9\text{V/A}$  range,  $\pm 4\%$  of reading on the  $10^{10}$  and  $10^{11}\text{V/A}$  ranges exclusive of noise, drift and current offset.

**RISE TIME (10% to 90%):** Adjustable in  $1\times$  and  $3.3\times$  steps from "Fast Rise Time" listed below to 330ms.

**NOISE vs. RISE TIME\*:**

GAIN V/A	FAST RISE TIME		WIDE DYNAMIC RANGE			
	RISE TIME (10%-90%)	DYNAMIC RANGE	NOISE (A RMS)	DYNAMIC RANGE	NOISE (A RMS)	RISE TIME (10%-90%)
$10^{11}$	1.5ms	100	$4 \times 10^{-13}$	$1.3 \times 10^4$	$3 \times 10^{-15}$	330ms
$10^{10}$	400 $\mu\text{s}$	200	$2 \times 10^{-12}$	$2 \times 10^4$	$2 \times 10^{-14}$	100ms
$10^9$	200 $\mu\text{s}$	400	$1 \times 10^{-11}$	$2 \times 10^4$	$2 \times 10^{-13}$	10ms
$10^8$	60 $\mu\text{s}$	800	$5 \times 10^{-11}$	$2 \times 10^4$	$2 \times 10^{-12}$	1ms
$10^7$	40 $\mu\text{s}$	2000	$2 \times 10^{-10}$	$2 \times 10^4$	$2 \times 10^{-11}$	100 $\mu\text{s}$
$10^6-10^4$	15 $\mu\text{s}$	2000	—	$2 \times 10^4$	—	100 $\mu\text{s}$

\*With up to 100pF input shunt capacitance. Noise and/or rise time increase as input shunt capacitance increases (1000pF maximum).

**STABILITY:** Current offset doubles per  $10^\circ\text{C}$  above  $25^\circ\text{C}$ . Voltage drift is less than  $0.005\% / ^\circ\text{C}$  and less than  $0.005\%$  per day of full output after 1-hour warmup.

**OFFSET CURRENT:** Less than  $10^{-12}\text{A}$  at  $25^\circ\text{C}$  and up to 70% relative humidity.

**CURRENT SUPPRESSION:**  $10^{-10}\text{A}$  to  $10^{-3}\text{A}$  in eight decade ranges with 0.1% resolution (10-turn potentiometer). Stability is  $\pm 0.2\%$  of suppressed value per  $^\circ\text{C}$ ,  $\pm 0.2\%$  per day.

**INPUT VOLTAGE DROP:** Less than  $400\mu\text{V}$  for full-scale output on the  $10^6$  to  $10^{11}\text{V/A}$  ranges when properly zeroed.

**EFFECTIVE INPUT RESISTANCE:** Less than  $15\Omega$  on the  $10^4$  and  $10^5\text{V/A}$  ranges, increasing to less than  $4\text{M}\Omega$  on the  $10^{11}\text{V/A}$  range.

**MAXIMUM INPUT OVERLOAD:** Transient: 1000V on any range for up to 3 seconds using a Keithley (or other 10mA-limited) high-voltage supply. Continuous: 500V on the  $10^{11}$  to  $10^7\text{V/A}$  ranges, decreasing to 200 on the  $10^6$ , 70 on the  $10^5$  and 20V on the  $10^4\text{V/A}$  ranges.

**OVERLOAD INDICATION:** Lamp indicates pre-filter or post-filter overload.

**DYNAMIC RESERVE:** 10 (20dB).

**CONNECTORS:** Input (front): BNC. Output (front and rear): BNC.

**POWER:** 90-125V or 180-250V (switch selected), 50-60Hz, 5W.

**DIMENSIONS, WEIGHT:** Style M, 90mm ( $3\frac{1}{2}$ " ) half-rack, overall bench size 100mm high  $\times$  220mm wide  $\times$  315mm deep ( $4" \times 8\frac{3}{4}" \times 12\frac{1}{2}"$ ). Net weight, 3.0kg (7 lbs.).

# Digital Picoammeter/480

Low Cost

- 1pA resolution
- Analog output
- Optional BCD or IEEE-488 outputs

The Model 480 is an easy-to-use, sensitive ammeter which resolves 1pA at an incredibly low price. Simple controls, shielded BNC input, high normal mode rejection and excellent overload specifications make it easy to use. The 480 measures DC current from 1pA per digit (2nA full range) to 2mA, with 3½-digit precision. Seven ranges cover the full span of low-current measurements. The input is simply connected into the circuit under test, the appropriate range selected and the current read from the digital display.

The 480 is extremely easy to use for measuring pA currents. The input voltage drop (burden) is actively constrained by feedback techniques to less than 200µV. This keeps the voltage burden in the circuit to a negligible level, permitting high accuracy measurements even with very low source voltages. High normal-mode line frequency rejection precludes the need for extensive shielding of the circuit being measured. High common-mode rejection and a floating input permit in-circuit measurements.

The 480, unlike older picoammeters, is designed to operate with high source capacitance. Worst-case design ensures that the circuit will be unconditionally stable (more than 15° phase margin) with up to 10,000pF source capacitance. This makes the instrument usable for capacitor testing, as well as in situations when long cables must be used. The input is readily connected into any low-current loop. Overload protection, up to 1000V transients, eliminates concern in handling and connecting the input leads. The built-in analog output is useful in making plots or as part of a control loop.

The field-installable Model 1788 Rechargeable Battery Pack allows



total isolation from line for portability or for critical floating measurements. The Model 1792 Isolated BCD Output converts the displayed reading to an electrically isolated, latched and buffered BCD format. Also available is the Model 1793 IEEE-488 Interface, enabling users to obtain automated readings with many low-cost controllers. Additional data include sign, overrange and busy. Logic levels are TTL/DTL and CMOS compatible. Installation of the 1792 precludes installation of the 1788 Battery Pack.

RANGE	MAXIMUM READING	ACCURACY (1 YEAR) 18°-28°C, UP TO 70% RH ±(% rdg + digits)	ANALOG RISE TIME (10%-90%)	NORMAL MODE REJECTION RATIO (50Hz OR 60Hz)	MAXIMUM ALLOWABLE INPUT
1 nA	1.999	0.8% + 4d	70ms	70dB	600V
10 nA	19.99	0.8% + 3d	70ms	70dB	600V
100 nA	199.9	0.5% + 3d	7ms	60dB	600V
1 µA	1.999	0.5% + 3d	7ms	60dB	600V
10 µA	19.99	0.5% + 3d	4ms	50dB	75V
100 µA	199.9	0.5% + 3d	1ms	50dB	75V
1mA	1.999	0.5% + 3d	1ms	50dB	20V

**MAXIMUM TRANSIENT OVERLOAD VOLTAGE:** 1000V for 3 seconds from a Keithley supply limited to 10mA.

**INPUT VOLTAGE BURDEN:** Less than 200µV.

**SETTLING TIME AT DISPLAY:** Less than 1 second.

**DISPLAY:** Four 0.5" LED digits with appropriate decimal point and polarity indication.

**CONVERSION PERIOD:** 400ms.

**OVERRANGE INDICATION:** Display blinks all zeros above 1999 counts.

**MAXIMUM COMMON MODE VOLTAGE:** 30V rms, DC to 60Hz sine wave.

**ANALOG VOLTAGE:**

Output Voltage: 1V = 1000 counts.

Output Resistance: 1000Ω.

**CONNECTORS:** Input: BNC. Output: Banana jacks.

**POWER:** 105-120V Or 210-250V (switch selected), 50-60Hz, 6W nominal, 20V•A max.

**DIMENSIONS, WEIGHT:** 85mm high × 235mm wide × 275mm deep (3½" × 9¼" × 10¾"). Net weight, 1.7kg (4 lbs.).

**ACCESSORIES SUPPLIED:** None.

**ACCESSORIES AVAILABLE:**

Model 1010: Single Rack Mounting Kit

Model 1017: Dual Rack Mounting Kit

Model 1788: Rechargeable Battery Pack

Model 1792: Isolated BCD Output

Model 1793: Isolated IEEE-488 Output

Model 4801: Input Cable

Model 4803: Low Noise Cable Kit

# 18000-20/Current Amplifier

## High Speed Amplifier

- Programmable ranges
- High speed
- Small size

The Model 18000-20 is a versatile, high-speed programmable linear picoammeter. It is designed for computer-controlled or automated operation in critical factors, and/or where it is desired to automatically select current sensitivity. Sensitivity, fast response, stability and low power consumption make it well suited for custom installation in analytical instruments, nuclear monitoring systems and component test sets.

Modifications to expand range, increase response speed or change range selection logic, range combination and scale factor can custom-tailor the 18000-20 to specific applications.



**RANGE:**  $\pm 10^{-10}$ A for full output to  $\pm 10^{-3}$ A in decade steps.

**RANGE SELECTION:** Three line binary input; "0" (000) corresponds to the  $10^{-10}$  range, "7" (111) corresponds to the  $10^{-3}$ A range. Logic level is TTL compatible (0 = closure to ground, 1 = +5V). Range Switching Time: Less than 2ms to any range,  $10^{-3}$  through  $10^{-8}$ A. Less than 10ms to the  $10^{-9}$  or  $10^{-10}$ A ranges.

RANGE (AMPERE)	RISE TIME (10%-90%)	NOISE P-P (% of full output)
$10^{-3}$	0.2ms	0.1%
$10^{-4}$	0.2ms	0.1%
$10^{-5}$	0.2ms	0.1%
$10^{-6}$	0.2ms	0.1%
$10^{-7}$	0.5ms	0.1%
$10^{-8}$	0.5ms	1.0%
$10^{-9}$	2.0ms	2.0%*(typical)
$10^{-10}$	2.0ms	

\*Typically 3% with 10pF shunting input, 5% at 50pF, increasing to 15% at 500pF. Gain ( $\Delta E_{out}/\Delta I_{in}$ ) is factory adjusted to within 1% of nominal. Internal adjustments are provided for recalibration.

**ZERO DRIFT:** Less than  $\pm 0.5\%$  of full output per week, noncumulative; better than 0.05% of full output per  $^{\circ}\text{C}$  after  $\frac{1}{2}$ -hour warm-up. Voltage offset is adjustable to zero. Offset current is less than  $10^{-11}$ A.

**INPUT DROP:** Less than 5mV.

**MAXIMUM OVERLOAD:** Transient: 1000V from a capacitance of  $0.01\mu\text{F}$ . Continuous: 30V (or 10mA current from a current-limited supply). Recovery from overload within 10ms.

**ANALOG OUTPUT:**  $\pm 10$ V at up to 2mA, noninverting.

**CONNECTORS:** Input: Microdot S-50 $\Omega$  series, screw type. Output: 15-pin card-edge with 0.156 in. spacing.

**POWER:** Power requirement is  $\pm 15$ V with 1% regulation. Current consumption is 30mA from +15V supply and 10mA from -15V supply.

**DIMENSIONS, WEIGHT:** 25mm high  $\times$  76mm wide  $\times$  127mm deep (1"  $\times$  3"  $\times$  5"). Net weight, 184gm (6 $\frac{1}{2}$  oz.).

**ACCESSORIES FURNISHED:** Mating input connector, mating card-edge connector for output, power and range control.



# Picoammeter/26000

## Logarithmic Picoammeter

- Logarithmic gain over 6 or 8 decades
- Optional positive or negative 300V supply available

The Model 26000 Series picoammeters provide logarithmic scales covering a wide range of current without switching. Current measurements are easily performed because the picoammeter can be directly connected to phototubes, photomultipliers, ion vacuum gauges, ion chambers and automated semiconductor-testing equipment.

The 26000 Series provides operational features such as a recover switch that allows quick recovery from large overloads, and a calibration check switch that allows a quick verification of high and low scales. An additional feature consists of a shorting link which may be used to connect input low to chassis ground.

An internally installed 300V source is available as an option.



### BASIC MODELS

MODEL NUMBER	RANGE SPAN, AMPERES	DECADE SPAN	CALIBRATION POINTS, AMPERES
26120	10 <sup>-3</sup> to 10 <sup>-11</sup>	8	10 <sup>-4</sup> /10 <sup>-10</sup>
26220	10 <sup>-4</sup> to 10 <sup>-12</sup>	8	10 <sup>-5</sup> /10 <sup>-11</sup>
26320	10 <sup>-7</sup> to 10 <sup>-13</sup>	6	10 <sup>-8</sup> /10 <sup>-11</sup>

### GENERAL

**TEMPERATURE COEFFICIENT:** Less than 2%/°C referred to input current from 10° to 30°C.

**RISE TIME:** Seconds to 90% of final current value (DAMPING control at minimum setting):

CURRENT CHANGE, AMPERES	CAPACITANCE ACROSS INPUT TERMINALS	
	NONE	5000pF
10 <sup>-12</sup> to 10 <sup>-7</sup>	1 second	2 seconds
10 <sup>-13</sup> to 10 <sup>-12</sup>	3 seconds	6 seconds

### LINEAR-LOG RELATIONSHIP:

Ideal:  $E_O = M \log I + C$ , where M = slope and C = offset of transfer function.

Actual:  $E_O$  actual will deviate from the best straight line by less than: 10mV from 10<sup>-3</sup> to 10<sup>-11</sup>A; 40mV at 10<sup>-12</sup>A; 300mV at 10<sup>-13</sup>A.

**RECORDER OUTPUT:** 1V per decade from minimum current to maximum current.

**GROUNDING:** Provision is made on rear panel for grounding instrument via a link between low and chassis.

**CONNECTORS:** Input: BNC type. Output: Microphone receptacle, XLR-3-32 (connectors located on rear panel).

**POWER:** 90-125V or 180-250V, 50-50Hz.

**ACCESSORIES SUPPLIED:** Set of mating connectors.

**DIMENSIONS, WEIGHT:** 140mm × 222mm × 330mm (5½" × 8¾" × 13"). Net weight 3.6kg (8 lbs.).

### OPTIONS AVAILABLE:

MODEL	DESCRIPTION
26X21	Power source installed, +300 volts
26X22	Power source installed, -300 volts

# 301, 302/Electrometer

## Operational Amplifiers

### Model 301

- $10^{12}\Omega$  input resistance
- $10^{-14}\text{A}$  input current
- Built-in power supply regulation

### Model 302

- Low cost
- Small size - PC mount
- $10^{-14}$  input current

The Model 301 Electrometer Operational Amplifier is a versatile, all solid-state differential input amplifier having a common mode input resistance of  $5 \times 10^{12}\Omega$ . Primarily used as a current amplifier, the 301 can be connected as a linear or logarithmic amplifier or integrator for signals from  $10^{-14}\text{A}$  to  $10^{-2}\text{A}$ . Input and feedback resistors can be mounted within the case to provide stable, fully shielded current amplification.

The unit is well suited for use as a linear current amplifier in gas chromatographs, mass spectrometers, photometers and nuclear reactor controls. Other uses are in biomedical instrumentation, semiconductor testing and process control equipment. The 301 can amplify currents from flame ionization detectors, vacuum gauges, ion chambers, density gauges, beta ray ionization detectors, electron multiplier and photomultiplier tubes. Built-in voltage regulators enable the 301 to be powered by unregulated sources over the range of  $\pm 19\text{V}$  to  $30\text{V}$ .

The Model 302 Electrometer Operational Amplifier is a low-cost, solid-state, single-ended amplifier intended for use primarily as a current amplifier. The 302 has an output of  $\pm 10\text{V}$  at  $5\text{mA}$  when operated from regulated voltages up to  $\pm 18\text{V}$ . Open loop gain is



12000. The 302 also features overload protection to  $\pm 100\text{V}$  continuous or  $\pm 400\text{V}$  momentary. Small size makes the 302 an excellent choice for circuit board mounting in OEM applications.

### Model 301

DC VOLTAGE GAIN, OPEN LOOP: Unloaded (min.): 50,000. Full load (min.): 30,000.

#### INPUT CHARACTERISTICS:

##### Common Mode:

Resistance (minimum):  $5 \times 10^{12}\Omega^*$   
Shunt Capacitance (maximum):  $10\text{pF}$ .  
Rejection (minimum):  $60\text{dB}$ .  
Voltage Limit:  $\pm 11\text{V}$ .

\*From  $-11\text{V}$  to  $+5\text{V}$  common mode, decreasing to  $10^{12}\Omega$  minimum at  $+11\text{V}$  common mode.

##### Between Inputs:

Resistance (minimum):  $10^{12}\Omega$ .  
Shunt Capacitance (maximum):  $10\text{pF}$ .

Overload Limit:  $\pm 400\text{V}$  continuous, either input to ground or between inputs.

Current Stability: Offset  $10^{-14}\text{A}$ .  
vs. time (worst case):  $10^{-15}\text{A}/24$  hours.  
vs. temperature (worst case): Doubles every  $5^\circ\text{C}$ .

Voltage Stability: Offset: Adjustable to zero.  
vs. time (worst case):  $2\text{mV}/\text{week}$  after 1-hour warmup.  
vs. temperature (worst case):  $150\mu\text{V}/^\circ\text{C}$ .

Current Noise:  $0.1\text{-}10\text{Hz}$  (max. peak-to-peak):  $5 \times 10^{-15}\text{A}$ .

Voltage Noise:  
 $0.1\text{-}10\text{Hz}$  (maximum rms):  $10\mu\text{V}$ .  
 $10\text{Hz-}500\text{kHz}$  (maximum rms):  $100\mu\text{V}$ .

#### FREQUENCY:

Gain Bandwidth Product (minimum):  $500\text{kHz}$ .  
Slewing Rate (minimum):  $0.3\text{V}/\mu\text{sec}$ .  
Rolloff (nominal):  $6\text{dB}/\text{octave}$ .

#### OUTPUT:

Amplifier:  $\pm 11\text{V}$  @  $11\text{mA}$ .  
Reference Voltage:  $\pm 15\text{V}$  @  $5\text{mA}$ .  
Regulation:  $\pm 1.0\%$  for  $10\%$  input change.

OPERATING TEMPERATURE:  $-25^\circ\text{C}$  to  $+85^\circ\text{C}$ .

CONNECTORS: Input: 2 push-on Teflon-insulated coaxial. All other: 15 terminal card edge.

POWER REQUIREMENTS:  $\pm 19\text{V}$  to  $\pm 30\text{V}$  unregulated,  $2\text{V}$  p-p maximum ripple,  $\pm$  current:  $16\text{mA}$ .

DIMENSIONS, WEIGHT:  $38\text{mm} \times 105\text{mm} \times 105\text{mm}$  ( $1\frac{1}{2}'' \times 4\frac{1}{4}'' \times 4\frac{1}{4}''$ ). Net weight,  $0.4\text{kg}$  ( $\frac{3}{4}\text{lb.}$ ).

ACCESSORIES SUPPLIED: Mating card-edge connector; two coaxial connectors.

### Model 302

DC VOLTAGE GAIN, OPEN LOOP: Unloaded (min.): 12,000. Full load (min.): 10,000.

#### INPUT CHARACTERISTICS:

##### Input Impedance:

Resistance (minimum):  $10^{12}\Omega$ .  
Shunt Capacitance (maximum):  $5\text{pF}$ .

Overload Limit:  $\pm 100\text{V}$  continuous,  $\pm 400\text{V}$  momentary.

Current Stability: Offset  $10^{-14}\text{A}$ .  
vs. time (worst case):  $10^{-15}\text{A}/24$  hours.  
vs. temperature (worst case): Doubles every  $5^\circ\text{C}$ .  
vs. supply (worst case):  $5 \times 10^{-15}\text{A}/\%$ .

Voltage Stability: Offset: Adjustable to zero.  
vs. time (worst case):  $2\text{mV}/\text{week}$  after 1-hour warmup.  
vs. temperature (worst case):  $150\mu\text{V}/^\circ\text{C}$ .  
vs. supply (worst case):  $1\text{mV}/\%$ .

Current Noise:  $0.1\text{-}10\text{Hz}$  (max. peak-to-peak):  $5 \times 10^{-15}\text{A}$ .

Voltage Noise:  
 $0.1\text{-}10\text{Hz}$  (maximum rms):  $10\mu\text{V}$ .  
 $10\text{Hz-}500\text{kHz}$  (maximum rms):  $100\mu\text{V}$ .

#### FREQUENCY:

Gain Bandwidth Product (minimum):  $150\text{kHz}$ .  
Slewing Rate (minimum):  $0.1\text{V}/\mu\text{sec}$ .  
Rolloff (nominal):  $6\text{dB}/\text{octave}$ .

OUTPUT:  $\pm 10\text{V}$  @  $5\text{mA}$ .

OPERATING TEMPERATURE:  $0^\circ\text{C}$  to  $+50^\circ\text{C}$ .

CONNECTORS: Input: Teflon-insulated feed through. All other: 0.025 pins, 0.2 in. long, 0.2 in. grid.

POWER REQUIREMENTS: Voltage:  $\pm 15\text{V}$  @  $5\text{mA}$ .

DIMENSIONS, WEIGHT:  $18\text{mm} \times 25\text{mm} \times 25\text{mm}$  ( $\frac{3}{4}'' \times 1'' \times 1''$ ). Net weight,  $10\text{gm}$  ( $\frac{1}{3}\text{oz.}$ ).

ACCESSORY AVAILABLE: Model 3021 Teflon-insulated socket with shield.

# Electrometers, Picoammeters/Accessories

	614	619	642	616	602	610C	480	427
Rack Mount Kits								
Single			2000	2000			1010	2000
Universal Fixed	1019A	1019A						
Universal Slide	1019S	1019S						
Dual							1017	
Cables, Leads								
Input	6011*	6011*		6011*	6011*	19072	4801	4801
BCD Output			1796				1796	
IEEE Output		7008	7008				7008	
Triax to Triax	7024	7024		7024	7024	7024		
Low Noise Kit							4803	4803
Interconnect Cable			6427					
Probes								
Static Detector	2503	2503		2503	2503	2503		
High Voltage	6103C	6103C		6103C	6103C	6103C		
Adapters								
Triax to Coax UHF	6012	6012		6012	6012			
Triax to BNC	6147	6147		6147	6147			
Triax Tee	6146	6146		6146	6146			
Guarded Input	6167	6191		6167	6167			
BNC Input			6424					
Rigid Air Line			6425					
Output Options								
IEEE-488		6193	6423				1793	
BCD			6422	6162			1792	
Power Options								
Battery Adapter			6428				1788	
Test Boxes								
Test Shield	6104	6104		6104	6104	6104		
Resistivity Chamber	6105	6105		6105	6105	6105		
Sapphire Insulated			6426					
Other								
Maintenance Kit		6195						
Electrometer Module		6194						
Dessicant Paper			6421					
Female Triax Cnctr.	7023	7023		7023	7023			

\*Supplied accessory.

# Selector Guide/Nanovoltmeters

MODEL	FEATURES	MEASURES VOLTAGES FROM TO		LOW NOISE WITH SOURCE RESISTANCES UP TO	24 HOUR ZERO DRIFT	POWER SOURCE
148	Most sensitive voltmeter.	< 1nV	100mV	30 $\Omega$	10nV	Battery or line
155	Analog null detector. Convenience and portability.	< 150nV	1 kV	300 k $\Omega$	500nV	C-Zn batteries
181	5½, 6½-digit resolution. Standard IEEE-488 interface.	< 30nV	1 kV	3M $\Omega$	50nV	Line
262	Voltage Divider.	Offers a convenient solution for calibration of nanovoltmeters. See pg. 73 for full specifications.				

Nanovoltmeters are sensitive DC voltmeters which extend the useful measurement range from microvolts to nanovolts. Thus they are useful in situations where resolution below  $1\mu\text{V}$  is needed or where high precision microvolt or millivolt measurements are to be made. Keithley nanovoltmeters are designed to minimize both thermal EMFs and noise over a wide range of source resistance.

**Model 181:**  $\mu\text{P}$ -based, fully programmable. The 181 is a  $\mu\text{P}$ -based digital nanovoltmeter with 10nV sensitivity, built-in IEEE-488 interface and 5½/6½-digit resolution. The front panel, with status annunciators and pushbutton zero control, is designed for ease of use. Its fast

(0.5s) response time, excellent stability (10nV/°C), low noise (30nV p-p), ranges up to 1kV, and low cost provide new standards for nanovoltmeters.

**Model 148:** The Model 148 is the most sensitive voltmeter available. It has 1nV sensitivity and utilizes FETs instead of subminiature tubes in the low noise amplifier.

**Model 155:** The Model 155 is a low cost, general purpose nanovoltmeter having 150nV noise. The Model 155 operates for 1000 hours on C-Zn batteries, and is an excellent null detector.



Measurements of DC signals with resolution of 1 to a few hundred nanovolts are easily made with various Keithley nanovoltmeters and null detectors. Certain phenomena which would be insignificant at ordinary voltage levels must be considered at this level since they may limit the useable resolution of the measurement. An understanding of the nature of these phenomena and of the principles used to minimize them is extremely useful in making meaningful measurements.

## Johnson noise

The ultimate limit of resolution in an electrical measurement is set by thermal agitation or Johnson noise generated in the circuit resistances. This noise voltage is proportional to the square root of the product of the absolute temperature, the bandwidth and the resistance.

### JOHNSON NOISE EQUATIONS

THE NOISE VOLTAGE DEVELOPED BY A METALLIC RESISTANCE IS:

$$E_{rms} = \sqrt{4 K T R F}$$

$E_{rms}$  — NOISE VOLTAGE,  $\mu V$   
 $K$  — BOLTZMAN'S CONSTANT ( $1.38 \times 10^{-23} J/^{\circ}K$ )  
 $T$  — TEMPERATURE,  $^{\circ}K$   
 $R$  — RESISTANCE,  $\Omega$   
 $F$  — NOISE BANDWIDTH, Hz

AT ROOM TEMPERATURE:

$$E_{rms} = 1.29 \times 10^{-10} \sqrt{R F}$$

$$E_{p-p} \approx 6.5 \times 10^{-10} \sqrt{R F}$$

The amount of noise in a given circuit can be reduced by reducing the bandwidth, by reducing the circuit resistance or by cooling the circuit. Reducing the bandwidth is the means most often used. However, this requires that a longer measuring time be allowed for a given accuracy. Reducing the resistance is not generally useful since the signal developed is reduced even more than the noise. For example, if the resistance of a shunt used to measure current is reduced by a factor of 100, the noise is reduced by a factor of 10, while the voltage drop across the shunt is reduced by a factor of 100. Cooling is sometimes the only available method for reducing the noise. A change from room temperature (293 $^{\circ}K$ ) to liquid nitrogen (77 $^{\circ}K$ ) will reduce the noise by a factor of approximately two.

## Thermal EMFs

Thermoelectric voltages are generated when junctions of dissimilar materials are at different temperatures. If all parts of a circuit are made of the same material, or if the entire circuit is at the same temperature, there will be no thermal EMF. These two principles are fundamental to good low-thermal design.

It is generally not possible to make an entire circuit of only one material. The thermal EMF of ordinary solder against copper is  $3\mu V/^{\circ}C$ . Low-thermal cadmium-tin solder, such as in Model 1503, will reduce

this thermal EMF by nearly ten times. Connections made by crimping copper sleeves and lugs are even better. When properly done, the resulting junction is cold-welded copper to copper and will generate very little thermal EMF. Low-thermal solder and low-thermal connection kits are available from Keithley Instruments.

### THERMAL EMF EQUATIONS

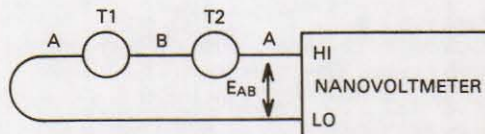

THE THERMAL EMF DEVELOPED BY DISSIMILAR METALS A AND B IN A SERIES CIRCUIT IS:

$$E_{AB} = \alpha_{AB} (T_1 - T_2)$$

$E_{AB}$  — THERMAL EMF,  $\mu V$   
 $\alpha_{AB}$  — THE THERMOELECTRIC VOLTAGE COEFFICIENT OF MATERIAL A WITH RESPECT TO B,  $\mu V/^{\circ}C$   
 $T_1$  — THE TEMPERATURE OF THE A TO B JUNCTION IN  $^{\circ}C$  OR  $^{\circ}K$   
 $T_2$  — THE TEMPERATURE OF THE B TO A JUNCTION IN  $^{\circ}C$  OR  $^{\circ}K$

After the number of dissimilar metal junctions has been reduced as much as possible, the circuit performance can be further improved by reducing the temperature gradients within the circuit. This can be done by placing the remaining junctions near one another, and by providing good thermal contact with a common heat sink. Most good electrical insulators are good thermal insulators as well—that is, they have very low thermal conductivity. Certain materials are available that combine good electrical insulation with high thermal conductivity, such as hard anodized aluminum, beryllium oxide, specially filled epoxy resins, sapphire and diamond. By using these materials together with a massive metallic heat sink, the temperature gradients across the remaining junctions will be minimized, as well as the thermal EMFs generated.

In addition, if the equipment is allowed to warm up and reach thermal equilibrium, and if the ambient temperature can be held constant, any remaining thermal EMFs will also be constant and can be compensated for by use of the zero suppression provided in Keithley nanovoltmeters. Obviously, it is unwise to place equipment or connections in direct sunlight, air currents from heating system vents, fan exhausts, etc.

## Magnetic fields

The motion of a conductor in a magnetic field, even one as weak as the earth's, can cause significant spurious signals in nanovolt measurements. The principal means for reducing this source of error is to reduce the area enclosed by the circuit. Minimizing motion of the

# Technical Data/Nanovoltmeters

various parts of the circuit will also help. It may be necessary to provide some form of magnetic shielding. The most useful materials for this are special alloys with a high permeability at low flux densities, such as  $\mu$ metal.

Troublesome magnetic fields may be generated within the circuit by conductors carrying large currents. By using twisted pairs of wires to carry large currents, the magnetic field generated may be largely canceled out.

## Ground loops

Frequently, a complete measuring system will have several points connected to earth ground. The power source, the experiment itself and the indicating instrument may all be grounded. If a small difference in potential exists between these points, a large ground current may circulate, causing unexpected voltage drops to occur. In making low level DC voltage measurements, it is desirable to have a single ground at one point. If the power source, the indicating instrument and other parts of the circuit are well isolated from earth ground, the most appropriate single point may be chosen with ease.

## MAGNETIC FIELD EQUATIONS

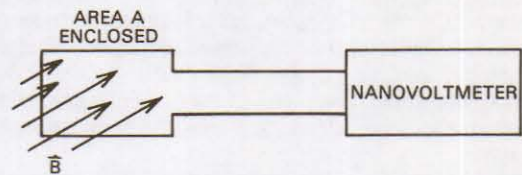

THE VOLTAGE DEVELOPED DUE TO A FIELD PASSING THROUGH A CIRCUIT ENCLOSING A PRESCRIBED AREA IS:

$$E_B = \int_A \frac{\partial \vec{B}}{\partial t} \cdot d\vec{A}$$

$\vec{B}$  = MAGNETIC FIELD INTENSITY, WEBERS/m<sup>2</sup> OR 10<sup>-4</sup> x GAUSS  
INTEGRAL IS TO BE EVALUATED OVER THE AREA ENCLOSED BY THE CIRCUIT

## GROUNDING CONFIGURATIONS

### MULTIPLE GROUNDS

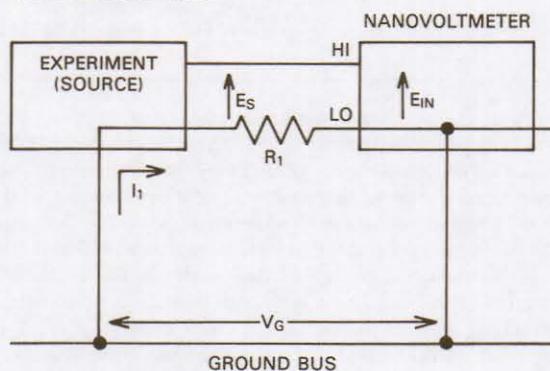

INPUT VOLTAGE TO THE NANOVOLTMETER IS:

$$E_{IN} = E_S + I_1 R_1$$

- $E_S$  — SOURCE VOLTAGE (DESIRED SIGNAL)
- $I_1 R_1$  — CURRENT PASSING THROUGH INPUT LO CONNECTION DUE TO GROUND VOLTAGES ( $V_G$ ) IN THE GROUND BUS (MAGNITUDE MAY BE mA's)
- $R_1$  — RESISTANCE OF INPUT LO CONNECTION (TYPICALLY AROUND 100m $\Omega$ )

$I_1 R_1$  MAY EXCEED  $E_S$  BY ORDERS OF MAGNITUDE  
 $\therefore E_{IN} = I_1 R_1$

### SINGLE GROUND

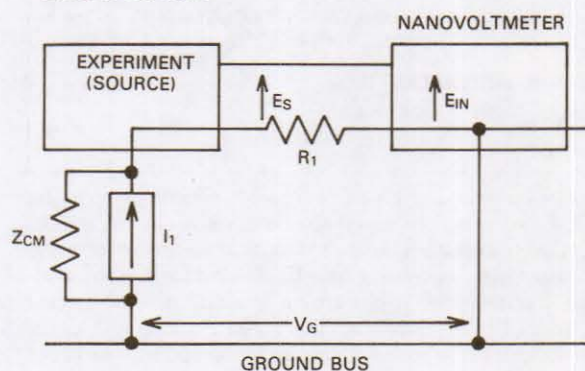

INPUT VOLTAGE TO THE NANOVOLTMETER IS:

$$E_{IN} = E_S + I_1 R_1$$

- $E_S$  — SOURCE VOLTAGE (DESIRED SIGNAL)
- $I_1 R_1$  — CURRENT PASSING THROUGH INPUT LO CONNECTION DUE TO COMMON MODE CURRENTS IN SOURCE (MAGNITUDE IS TYPICALLY nA's)
- $R_1$  — RESISTANCE OF INPUT LO CONNECTION (TYPICALLY AROUND 100m $\Omega$ )

$E_{IN} = E_S$   
 $I_1 R_1$  IS INSIGNIFICANT COMPARED TO  $E_S$ . THE COMMON MODE IMPEDANCE IS TYPICALLY M $\Omega$ 's. THUS  $V_G$  GENERATES  $I_1$  OF ONLY nA's.

- 1nV sensitivity
- 10nV per day drift
- $10^8$  gain

No other commercially available room-temperature voltmeter has the voltage sensitivity and stability of the Keithley Model 148 Nanovoltmeter. Input noise of less than 0.2nV rms permits 1nV resolution on the most sensitive range. Zero drift of less than 10nV per 24 hours makes the Model 148 an excellent instrument for long term drift measurements from low resistance sources.

Full-scale ranges from 10nV to 100mV and an accuracy of  $\pm 2\%$  of full scale let you make accurate DC measurements in the nV region without setting up special vibration sensitive equipment. On its most sensitive range, line frequency rejection greater than 3000:1 permits use with large superimposed AC signals and reduces external shielding requirements for easier measurement set-ups.

Front panel controlled zero suppression allows the 148 to measure small changes in a large DC signal. The stability of the zero suppression circuit permits up to 100 times full scale suppression.

When highly critical measurements require complete isolation from ground loop and line frequency effects, or when line current is unavailable, the Model 148 will run on its internal batteries. The batteries charge automatically when the unit is reconnected to line.

A 1V, 1mA output lets the Model 148 drive other instruments, or function as a highly sensitive DC amplifier, with gain as high as  $10^8$ .

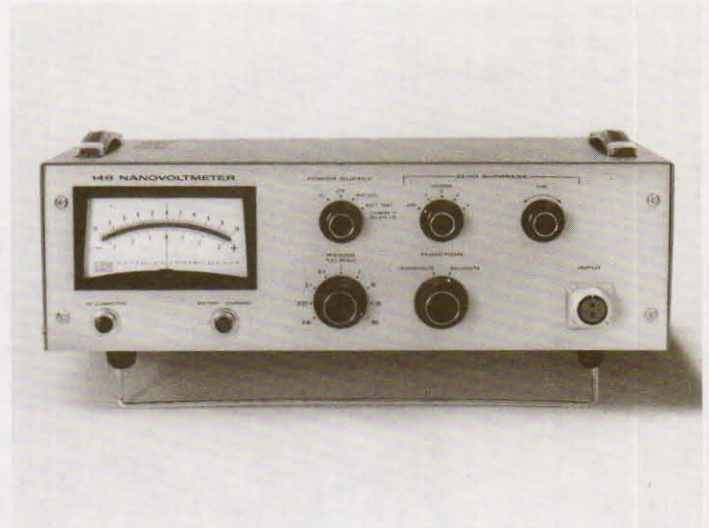

**RANGE:** 10nV ( $10 \times 10^{-9}$ V) full scale to 100mV on a zero-center meter. 18 overlapping ranges in  $1\times$  and  $3\times$  steps.

**ACCURACY:** Meter:  $\pm 2\%$  of full scale on all ranges. Output Terminals:  $\pm 1\%$  of full scale on all ranges (excluding noise and drift).

**ZERO DRIFT:** Less than 10nV per 24 hours after 1-hour warmup with reasonably constant ambient temperature. Long-term drift is non-cumulative.

**INPUT NOISE (with input shorted):** Less than 0.2nV rms (1nV peak-to-peak) on most sensitive range.

**RESOLUTION:** Better than 1nV on most sensitive range.

#### INPUT CHARACTERISTICS:

RANGE	INPUT RESISTANCE	MAXIMUM SOURCE RESISTANCE <sup>1</sup>	LINE FREQUENCY REJECTION <sup>2</sup>
10nV	> 1 k $\Omega$	10 $\Omega$	3000:1
30nV	> 3 k $\Omega$	30 $\Omega$	1000:1
100nV	> 10 k $\Omega$	100 $\Omega$	1000:1
300nV	> 30 k $\Omega$	300 $\Omega$	500:1
1 $\mu$ V	> 100 k $\Omega$	1k $\Omega$	300:1
3 $\mu$ V to 100 $\mu$ V	> 300 k $\Omega$	3k $\Omega$	100:1 decreasing to 50:1
0.1 to 100mV	> 1M $\Omega$	10k $\Omega$	100:1 decreasing to 5:1

<sup>1</sup>Source resistances higher than the recommended maximum will increase noise and rise time.

<sup>2</sup>Ratio of impressed peak-to-peak line frequency voltage at input to indicated DC voltage.

**LINE FREQUENCY REJECTION:** 3000:1 on most sensitive range. (See note 2 above.)

**COMMON MODE REJECTION:** 50 or 60Hz: greater than 160dB. 100 or 120Hz: greater than 140dB. (See note 2 above.)

**ISOLATION (circuit ground to chassis ground):** Greater than  $10^8\Omega$  shunted by 0.05 $\mu$ F. Circuit ground may be floated up to  $\pm 400$ V with respect to chassis ground. On battery operation, instrument may be completely isolated from power line and ground.

#### RISE TIME (10% to 90%):

**30nV Range:** Less than 2 seconds when source resistance is less than 10% of maximum; 4 seconds using maximum source resistance. Rise time is about 3 times longer on 10nV range.

**0.1 $\mu$ V to 100mV Ranges:** Less than 0.5 second when source resistance is less than 10% of maximum; 3 seconds using maximum source resistance.

**ZERO SUPPRESSION:** Up to at least 100 $\mu$ V on the microvolt ranges and up to at least 100mV on the millivolt ranges. Stability is such that 100 times full scale may be suppressed.

#### RECORDER OUTPUT:

**Output:**  $\pm 1$ V DC at up to 1mA for full-scale meter deflection.

**Resistance:** Less than 5 $\Omega$  within the amplifier pass band.

**Gain:** 1V/range setting in volts.

**Noise:** Input noise times gain plus modulation products.

**Modulation Products:** Less than 2% peak-to-peak of full scale with input shorted.

**CONNECTORS:** Input: Special Keithley Model 1485. Output: Amphenol 80PC2F.

**POWER:** Line Operation: 105-125V or 210-250V (switch selected). 60Hz, 16W. Battery Operation: Rechargeable nickel-cadmium 6V battery pack.

**DIMENSIONS, WEIGHT:** 133mm (5 $\frac{1}{4}$ " ) full rack, overall bench size 155mm high  $\times$  440mm wide  $\times$  325mm deep (6 $\frac{1}{4}$ "  $\times$  17 $\frac{1}{2}$ "  $\times$  13"). Net weight, 8.7kg (20 lbs.).

**ACCESSORIES SUPPLIED:** Model 1481 Low-Thermal Input Cable with alligator clips; mating output and demodulator test plugs; internally mounted nickel-cadmium battery pack and charging circuit.

# 181/Digital Nanovoltmeter

## System/Bench

- 6½-digit resolution
- 10nV sensitivity
- Standard IEEE-488 interface

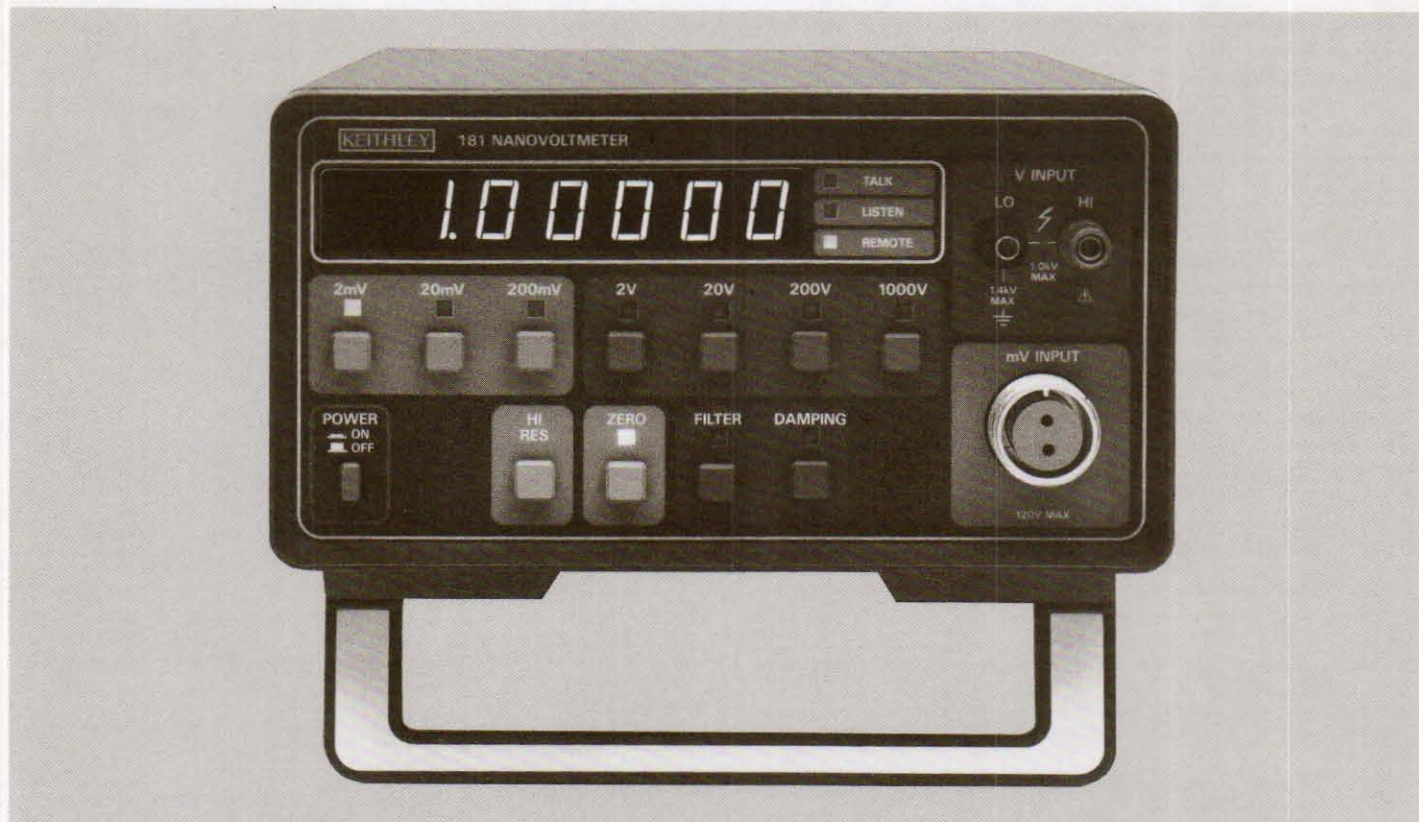

### 10nV sensitivity

The 181 was designed to provide useable 10nV sensitivity. A proprietary JFET input amplifier provides the ultra-low noise and high linearity required for this application.

The 181 should not be confused with  $\mu$ P DMMs that average microvolt readings, then display "nanovolts". The 181 is optimized for nanovolt measurements. Thus, as opposed to averaging DMMs, the 181 makes measurements below 1 $\mu$ V quickly and repeatably.

### Stability

The 181's zero stability is typically 10nV/°C for ambient temperature rates of change of less than 2°C/hr.

### Rapid response with low noise

Both are provided by the discontinuous digital filter which acts on the rate of input change. When a large input change is sensed with DAMPING OUT, the  $\mu$ P switches off its 3-pole digital filter to allow a fast reading update which will settle to  $\pm 0.012\%$  of end range within 0.5 second. The filter is then switched on for low noise settling to the final value. DAMPING IN keeps the filter active at all times, eliminating discontinuities when the input changes rapidly.

### Other features

- The readout can be expanded from 5½-digit to 6½-digit resolution

by depressing the HI RES pushbutton. 6½ digits are always available on the IEEE-488 bus.

- All front panel controls are programmable.
- Front panel annunciator lamps continuously update instrument status. This is particularly helpful in system applications.
- An isolated analog output is provided which can be set to represent either the three least significant decades or the three most significant decades of the displayed reading.
- The mV Input connector is manufactured with special low thermal EMF materials to minimize zero shifts and offsets.
- The Zero control also serves as a baseline suppression, since all readings displayed are the difference between the stored baseline and the actual voltage.
- Standard Cells and other delicate sources are not disturbed by the input resistance of 1G $\Omega$  and the 5nF input capacitance.

### Model 181 calibration

The Model 262 Low Thermal Voltage Divider is designed for calibration of the 181 and sensitive DMMs. The 262 has voltage division ranges from 10<sup>2</sup>:1 to 10<sup>5</sup>:1 in steps of  $\times 10$ . The accuracy at 10<sup>2</sup>:1 is  $\pm 35$ ppm with stability of 2ppm/°C. The 262 is intended to be used with the customer's precision DC calibrator. A mating cable to the 181 is included.



### DC VOLTS

RANGE	5½-DIGIT RESOLUTION	ACCURACY ±(%rdg + digits)		TEMPERATURE COEFFICIENT ±(%rdg + digits)/°C 0°-18°C & 28°-35°C	INPUT RESISTANCE	MAXIMUM ALLOWABLE INPUT	NMRR (LINE FREQUENCY)
		24 HR., 22°-24°C	1 YR., 18°-28°C				
2mV	10 nV	0.006% + 5 d*	0.015% + 5d*	0.002 % + 3d	>1GΩ	120V**	> 90dB
20mV	100 nV	0.006% + 2 d*	0.015% + 2d*	0.002 % + 0.5d	>1GΩ	120V**	> 80dB
200mV	1 μV	0.006% + 2 d	0.015% + 2d	0.002 % + 0.2d	>1GΩ	120V**	> 80dB
2 V	10 μV	0.004% + 1.5d	0.007% + 2d	0.0007% + 0.2d	>1GΩ	1000V	> 60dB
20 V	100 μV	0.004% + 1.5d	0.01 % + 2d	0.0008% + 0.2d	10MΩ	1000V	> 60dB
200 V	1mV	0.004% + 1.5d	0.01 % + 2d	0.0008% + 0.2d	10MΩ	1000V	> 60dB
1000 V	10mV	0.005% + 1.5d	0.01 % + 2d	0.0012% + 0.2d	10MΩ	1000V	> 60dB

\*When properly zeroed.

\*\*10 seconds maximum; 35V rms continuous.

CMRR: 160dB on mV ranges, 140dB on V ranges; at DC and line frequency (50 or 60Hz).

### IEEE-488 BUS IMPLEMENTATION

Multiline Commands: DCL, LLO, SDC, GET.

Uniline Commands: IFC, REN, EOI, SRQ, ATN.

### PROGRAMMABLE PARAMETERS:

Front Panel Controls: Range, Filter, Zero, Damping, Hi Resolution.

Internal Parameters: SRQ Response, Trigger Modes, Data Terminators.

ADDRESS MODES: TALK-ONLY and ADDRESSABLE.

### TRIGGER MODES:

One Shot: Updates output buffer once at first valid conversion after trigger on TALK and/or GET.

Continuous: Updates output buffer at all valid conversions after trigger.

### GENERAL

NOISE: Less than 30nV p-p on lowest range with Filter on.

INPUT CAPACITANCE: 5000pF on mV ranges.

SETTLING TIME: 0.5 sec. to within 25 digits of final reading with Filter on, Damping off.

FILTER: 3-pole digital; RC = 0.5, 1 or 2 seconds depending on range.

CONVERSION SPEED: 4 readings/second.

DISPLAY: Seven 13mm (0.5 in.) LED digits with appropriate decimal point and polarity.

OVERLOAD INDICATION: Display indicates polarity and OFLO.

### ANALOG OUTPUT:

Accuracy: ±(0.15% of displayed reading + 1mV).

Time Constant: 400ms.

Level: ±2V full scale on all ranges; X1 or X1000 gain.

ISOLATION: Input LO to Output LO or power line ground: 1400V peak, 5 × 10<sup>9</sup>V•Hz, greater than 10<sup>9</sup>Ω paralleled by 1500pF.

WARMUP: 1 hour to rated accuracy when properly zeroed.

### ENVIRONMENTAL LIMITS:

Operating: 0°C to 35°C, 0% to 80% relative humidity.

Storage: -25°C to 65°C.

POWER: 105-125V or 210-250V (internal switch selected), 50-60Hz, 30V•A maximum.

INPUT CONNECTORS: Special low thermal for 200mV and lower ranges. Binding posts for 2V to 1000V ranges.

DIMENSIONS, WEIGHT: 127mm high × 216mm wide × 359mm deep (5" × 8½" × 14¼"). Net weight 3.85kg (8½ lbs.).

ACCESSORY SUPPLIED: Model 1506 Low Thermal Input Cable.

### ACCESSORIES AVAILABLE:

Model 262: Low Thermal Voltage Divider

Model 1483: Low Thermal Connection Kit

Model 1484: Refill Kit for 1483 Kit

Model 1485: Female Low Thermal Input Connector

Model 1486: Male Low Thermal Input Connector

Model 1488: Low Thermal Shorting Plug

Model 1503: Low Thermal Solder and Flux

Model 1506: Low Thermal Input Cable (4 ft., Clips)

Model 1507: Low Thermal Input Cable (4 ft., Lugs)

Model 1815: Maintenance Kit

# 155/Microvoltmeter

## Null Detector

- 150nV to 1kV
- 1000-hour battery life
- $10^{12}\Omega$  isolation

The Model 155 Null Detector-Microvoltmeter is a high-performance, low-cost instrument with better than 150nV resolution and full-scale ranges up to 1kV. Its electrical and physical ruggedness, plus broad range and high common- and normal-mode rejection, make it one of the most versatile voltmeters available for applications in standards labs, development labs, production testing and basic research.

As a null detector, the guarded battery-operated 155 is often used with potentiometers, bridges, Kelvin-Varley dividers and for amplifier gain and linearity measurements. The 155 can recover from 100V overloads within 5 seconds on the 30mV and higher ranges. Up to 1200V peak may be applied momentarily on any range without damaging the instrument.

A  $\pm 1V$  at 1mA output is located on the rear panel for connection to recorders or other readout devices. Accuracy is  $\pm 2\%$  of full scale at the meter and  $\pm 1\%$  at the rear panel recorder output.

The Model 155 is designed for battery operation to minimize ground loop and high frequency pick-up problems in sensitive voltage measurements. Four internally mounted standard batteries provide greater than 1000 hours operation.

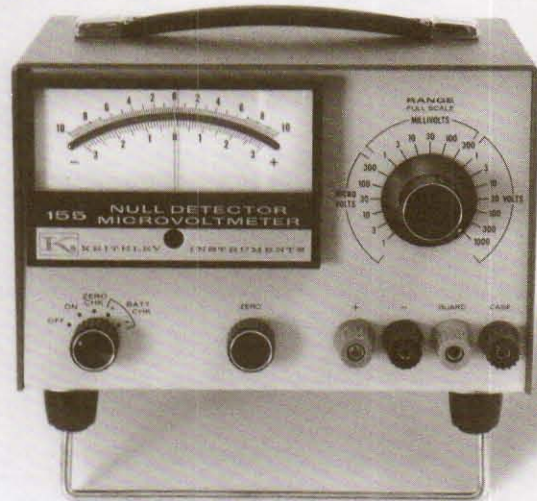

**RANGE:**  $\pm 1\mu V$  full scale to  $\pm 1000V$  on zero center meter in 19 overlapping  $1\times$  and  $3\times$  ranges.

**ACCURACY:**  $\pm 1\%$  of full scale at recorder output,  $\pm 2\%$  of full scale at meter, exclusive of noise and drift.

**ZERO DRIFT:** Less than  $0.5\mu V$  per 24 hours, typically less than  $0.1\mu V$  per  $^{\circ}C$ . Long-term drift is non-cumulative.

**METER NOISE:** Less than  $0.03\mu V$  rms ( $0.15\mu V$  peak-to-peak) on most sensitive range with input shorted.

**INPUT RESISTANCE:**

- 100M $\Omega$  — 3V to 1kV ranges;
- 10M $\Omega$  — 300mV to 1V ranges;
- 1M $\Omega$  —  $1\mu V$  to 100mV ranges.

**NORMAL MODE REJECTION:** An applied 50-60Hz signal which is 80dB greater than full scale peak-to-peak will not affect reading on most sensitive range (equivalent to 100dB NMRR). Rejection decreases to 20dB on the 10mV and higher ranges. Peak AC plus DC must never exceed 1200V.

**COMMON MODE REJECTION:** Common mode voltage — DC or 50-60Hz — 120dB greater than full scale up to 1200V peak will not affect reading (equivalent to 140dB CMRR).

**ISOLATION:** Greater than  $10^{12}\Omega$  shunted by  $0.01\mu F$  between chassis ground (case) and input LO at up to 50% relative humidity and  $25^{\circ}C$ .

**RISE TIME (10%-90%):** 1 second on  $10\mu V$  range and above, increasing to 5 seconds on  $1\mu V$  range.

**ZERO SUPPRESSION:**  $\pm 25\mu V$ .

**RECORDER OUTPUT:**  $\pm 1V$  at up to 1mA.

**OVERLOAD:** Up to 1200V peak may be applied momentarily on any range. Recovery from overload  $10^6$  times full scale for 1 second with  $10k\Omega$  source is within 5 seconds on the 30 $\mu V$  and higher ranges, increasing to 20 seconds on the  $1\mu V$  range.

**CONNECTORS:** Output: Barrier strip. Input: Binding posts.

**POWER:** Four internally mounted zinc-carbon batteries (2N6) provide more than 1000 hours continuous operation. Barrier strip provided for external power supply.

**DIMENSIONS, WEIGHT:** Overall bench size 165mm high  $\times$  210mm wide  $\times$  185mm deep ( $6\frac{1}{2}'' \times 8\frac{3}{4}'' \times 7\frac{3}{4}''$ ). Net weight, 2.5kg (6 lbs.).

# Voltage Divider/262

## Low Thermal Voltage Divider

- Low thermal switching
- Input remote sense terminals
- Easy to operate

Traditionally, analog nanovoltmeters have required calibrators with a high degree of zero stability, but accuracy of only a few tenths of a percent was more than adequate. Now Keithley has produced a  $\mu\text{P}$ -based nanovoltmeter, Model 181, with 10nV sensitivity and which requires a calibration accuracy of 0.005%.

The Model 262 offers a convenient solution for calibration. The Model 262 provides the necessary thermal stability for even the most sensitive nanovoltmeters, such as Model 148. It is accurate enough to calibrate the most sophisticated nanovoltmeters, such as Model 181. In addition, it takes the burden out of calibrating today's  $\mu\text{V}$ -sensitive DMMs. The Model 262 is the only instrument of its kind with the thermal stability critical for these applications.

In the past, a user had to be skilled in the art of nanovolt technology in order to design the cables and circuitry required to calibrate the 181. An alternative was to use expensive resistance standards which had the required precision but not the low thermal stability. Low thermal connections were complex—copper lugs and clips had to be used and were vulnerable to air currents.

The Model 262 contains a simple passive divider enclosed in a cast aluminum housing to minimize thermal effects. It uses low thermal switching for ratio selection. Input remote sense terminals maintain source accuracy using standard banana plug adapters. Output is provided via one female low thermal connector. A male-to-male low thermal cable is provided for connecting to Keithley nanovoltmeters;

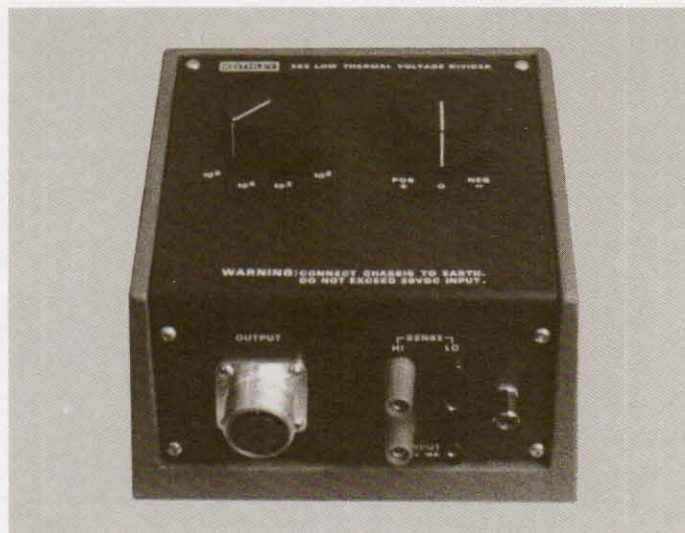

the Model 1507 low thermal cable with lugs may be used with other equipment.

The Model 262 is easy to operate and provides stable calibration signals when driven with a precision DC calibration source, which may be found in any standards lab. Three adjustments are easily accessed for yearly calibration. Equipment for calibration of the Model 262 is also available in any standards lab.

DIVIDER RATIO	ACCURACY (1 YR.)* 22°-24°C	TEMPERATURE COEFFICIENT 18°-28°C	OUTPUT NOISE (0.1Hz Bw)	THERMAL DRIFT**
10 <sup>2</sup> :1	± 35ppm	2ppm/°C	10nV p-p	10nV
10 <sup>3</sup> :1	± 35ppm	2ppm/°C	10nV p-p	10nV
10 <sup>4</sup> :1	± 100ppm	10ppm/°C	1nV p-p	3nV
10 <sup>5</sup> :1	± 100ppm	10ppm/°C	1nV p-p	3nV

\*Referenced to output terminals.

\*\*For ambient temperature changes of no more than 1°C/hour. Includes effects of supplied cable.

**INPUT RESISTANCE:** 20k $\Omega$  for divider ratios of 10<sup>2</sup>:1 and 10<sup>4</sup>:1; 200k $\Omega$  for divider ratios of 10<sup>3</sup>:1 and 10<sup>5</sup>:1.

**OUTPUT RESISTANCE:** 2 $\Omega$  for divider ratios of 10<sup>4</sup>:1 and 10<sup>5</sup>:1; 200 $\Omega$  for divider ratios of 10<sup>2</sup>:1 and 10<sup>3</sup>:1.

**OVERLOAD PROTECTION:** Maximum operating input voltage is 20V. Input is protected against 1000V overloads from calibrators with current limits up to 150mA.

**CONTROLS:** Polarity, divider ratio.

**CONNECTORS:** Input: 5-way binding posts for input, sense and case ground. Output: Special low thermal female connector; mates with Models 1506, 1507, 1481 and 1482.

**ENVIRONMENTAL LIMITS:** Operating: 18°-28°C, 0 to 60% relative humidity. Storage: -25°C to 65°C.

**DIMENSIONS, WEIGHT:** 114mm high  $\times$  165mm wide  $\times$  184mm deep (4½"  $\times$  6½"  $\times$  7¼"). Net weight 2kg (4½ lbs.).

**ACCESSORY SUPPLIED:** Low thermal male-to-male cable (3 ft.) for connecting to Models 148 and 181.

#### ACCESSORIES AVAILABLE:

Model 1481: Low Thermal Twin Lead Shielded Input Cable (4 ft. with clips)

Model 1482: Low Thermal Twin Lead Shielded Input Cable (10 ft. with bare copper leads)

Model 1483: Low Thermal Connection Kit

Model 1484: Refill Kit for 1483 Kit

Model 1485: Female Low Thermal Input Connector

Model 1486: Male Low Thermal Input Connector

Model 1503: Low Thermal Solder and Flux

Model 1506: Low Thermal Triax Input Cable (4 ft. with clips)

Model 1507: Low Thermal Triax Input Cable (4 ft. with lugs)

# Selector Guide/Nanovoltmeter Accessories

	155	148	181
Rack Mounting Kits			
Universal Fixed			1019A
Universal Slide			1019S
Input Cables			
Low Thermal Coax, Male Connector/ Alligator Clips		1481*	1481
Low Thermal Coax, Male Connector/ Bare Copper Leads		1482	1482
Low Thermal Triax, Male Connector/ Alligator Clips		1506	1506*
Low Thermal Triax, Male Connector/ Spade Lugs		1507	1507
Input Connectors			
Male Input		1486	1486
Female Input		1485	1485
Shorting Plug		1488	1488
Low Thermal Connection Kit		1483	1483
Refill Kit for 1483 Kit		1484	1484
Battery Pack		1489*	
Low Thermal Solder and Flux	1503	1503	1503
Voltage Divider	262	262	262
Maintenance Kit			1815

\*Supplied

# Sources/Selector Guide

MODEL	FEATURES	OUTPUT		ACCURACY	COMPLIANCE
		FROM	TO		
<b>CURRENT SOURCES</b>					
220	Std. IEEE-488. 100-point memory. External trigger.	$\pm 500\text{fA}$	$\pm 100\text{mA}$	$\pm 0.05\%$ setting	$\pm(1\text{V} - 105\text{V})$ adjustable.
225	AC modulation. Input floating.	$\pm 100\text{pA}$	$\pm 100\text{mA}$	$\pm 0.5\%$	10V - 100V
227	Programmable.* 50W output.	$\pm 1\mu\text{A}$	$\pm 1\text{A}$	$\pm 0.5\%$	3V - 300V
261	Picoampere calibration source.	$\pm 10\text{fA}$	$\pm 110\mu\text{A}$	$\pm 0.25\%$ to $\pm 2\%$	10mV - 10V
<b>VOLTAGE SOURCES</b>					
230	Std. IEEE-488. 100-point memory. External trigger.	$\pm 50\mu\text{V}$	$\pm 100\text{V}$	$\pm 0.05\%$ setting	$\pm(2\text{mA}, 20\text{mA}, 100\text{mA})$
247	High voltage. 0.02% stability.	$\pm 0$	$\pm 3\text{kV}$	$\pm(0.25\% + 1.5\text{V DC})$	6mA

\*With optional accessory.

The Model 220 Programmable Current Source and Model 230 Programmable Voltage Source are part of our System Components line. Both models have  $\pm(0.05\%$  reading +  $0.05\%$  full scale) basic accuracy, waveforms that can be programmed from the front panel or IEEE-488 bus, Digital Self Test, Trigger In/Out and Digital I/O.

Model 225 and Model 227 are active current sources with selectable compliance limits. The Model 225 provides lower current outputs and has less noise. The Model 227 has up to 300V compliance and can provide 50 watts of output power. Range, current level and compliance are programmable using an optional accessory.

The Model 261 is an accurate low current source for use in calibrating picoammeters and electrometers, or for stable cancellation of background currents.

The Model 247 is a high voltage power source with maximum output of  $\pm 3\text{kV}$  DC at 6mA. The unit is designed with the stability, low noise and accuracy to make it ideal for use with photomultiplier tubes, nuclear detectors, and in resistivity testing. The Model 247 features a front panel meter, front panel polarity reversal and locking fine voltage adjust potentiometer.

# 220, 230/Programmable Sources

## Current/Voltage Sources

### Model 220

- $\pm 0.5\mu\text{A}$  to  $\pm 101\text{mA}$  DC output
- $10^{14}\Omega$  output resistance
- $\pm 1\text{V}$  to  $\pm 105\text{V}$  programmable V-LIMIT

### Model 230

- $\pm 50\mu\text{V}$  to  $\pm 101\text{V}$  DC output
- $\pm 2\text{mA}$ ,  $\pm 20\text{mA}$ ,  $\pm 100\text{mA}$  programmable I-LIMIT
- Remote sensing

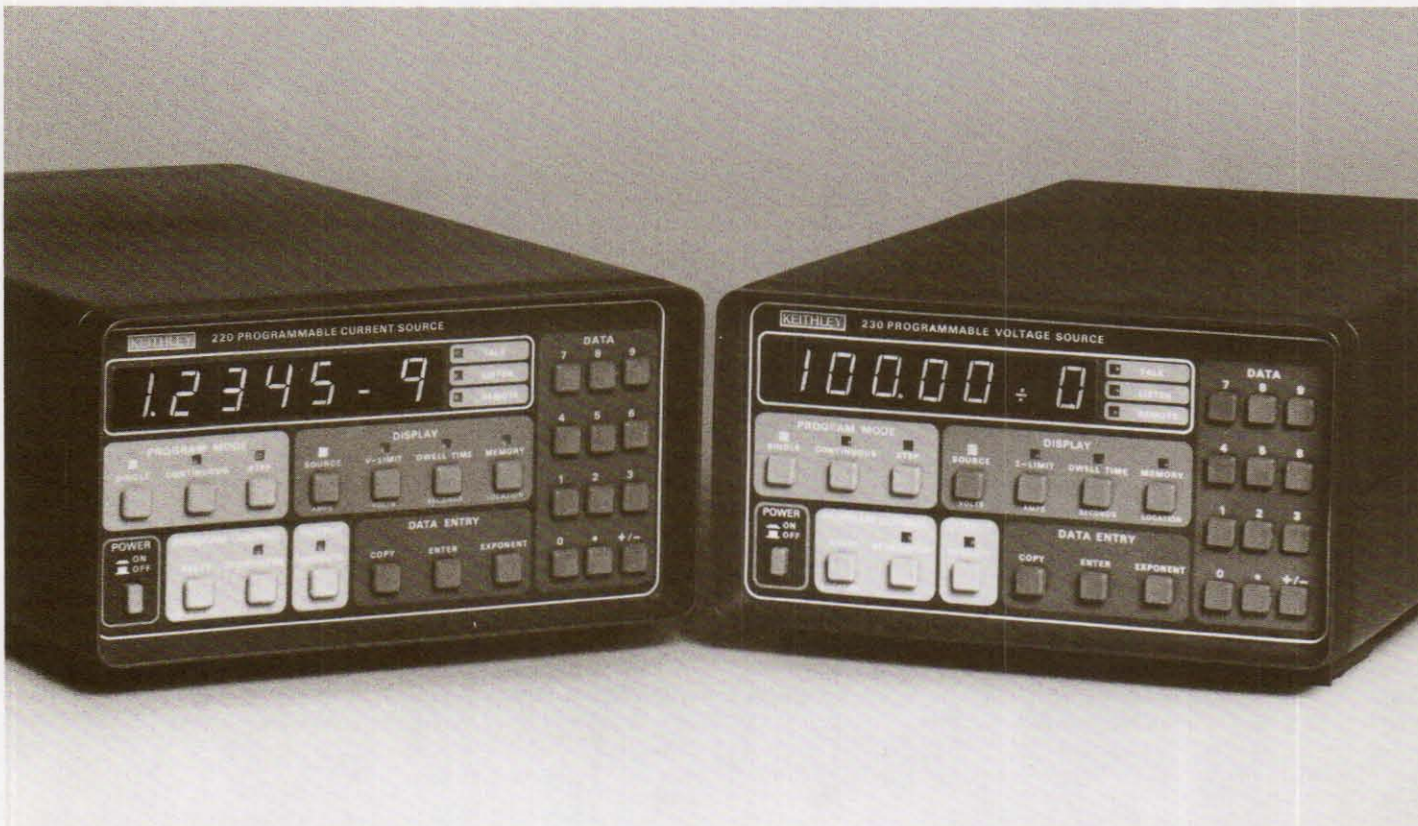

The demand on researchers, designers and evaluation engineers for better device characterization has generated a widespread need for programmable, low-level DC sources. As the acknowledged leader in sensitive measurement instrumentation, it was only natural for Keithley to meet that need. And, as an experienced manufacturer of automatic wafer measuring equipment, Keithley knows the importance to the user of instrument compatibility and ease of system integration. The new 220 Programmable Current Source and 230 Programmable Voltage Source will find major applications in semiconductor characterization, materials research and ATE systems.

Both models incorporate a 100-step, user-programmable memory buffer which is useful in applications where either a fixed number of outputs is repeated, or a complex waveform of discrete steps must be generated.

In system applications, the waveform can be loaded through the bus and the 220 and 230 commanded to enter their routines while the controller is busy on other tasks.

The Trigger In/Out feature, when used in the STEP mode, allows the source to synchronize the measurements of other instruments such as the 619 Electrometer/Multimeter. The TRIGGER OUT occurs after the completion of dwell time; TRIGGER IN causes the 220 or 230 to advance to its next program step. This provides the capability to perform a preset source-measurement without the need for a computer.

Four TTL-compatible input and output (I/O) lines are provided on each model to receive and generate system commands. In a typical application, a source can be programmed by the customer to generate an SRQ (service request) to the controller if a system element such as a foot pedal, parts handler, mechanical stop or over-temperature detector dictates.

The 230 can be employed as a D/A converter to drive commercial analog programmable power supplies. For safety in a system environment, the I/O can provide a means for the customer to shut down the power supply upon an over-voltage condition. Digital I/O is an example of the convenience features that make the Models 220 and 230 true configurable system components, not just sources.

# Programmable Sources/220, 230

## Current/Voltage Sources

### Model 220

RANGE	MAXIMUM OUTPUT	ACCURACY (1 YEAR) 18°-28°C	STEP SIZE	TEMPERATURE COEFFICIENT/°C 0°-18°C & 28°-50°C
100mA	±101.00mA	0.1 % + 50µA	50µA	0.01 % + 2µA
10mA	±19.995mA	0.05 % + 10µA	5µA	0.005 % + 200nA
1mA	±1.9995mA	0.05 % + 1nA	500nA	0.005 % + 20nA
100 µA	±199.95 µA	0.05 % + 100nA	50nA	0.005 % + 2nA
10 µA	±19.995 µA	0.05 % + 10nA	5nA	0.005 % + 200pA
1 µA	±1.9995 µA	0.1 % + 1nA	500pA	0.01 % + 20pA
100 nA	±199.95 nA	0.3 % + 100pA	50pA	0.02 % + 2pA
10 nA	±19.995 nA	0.3 % + 10pA	5pA	0.02 % + 200 fA
1 nA	±1.9995 nA	0.4 % + 2pA	500 fA	0.02 % + 200 fA

OUTPUT RESISTANCE: Greater than  $10^{14}\Omega$ .

OUTPUT CAPACITANCE: Less than 20pF.

LINE REGULATION: Less than 0.01% for AC power line changes within specified limits.

VOLTAGE LIMIT: Bipolar, 1 to 105 volts in 1V programmable steps.

RESPONSE TIME: Less than 3ms to within 0.1% of programmed change.

TRANSIENT RECOVERY TIME: Less than 3ms to rated accuracy following any change in compliance voltage.

NOISE:

RANGE	NOISE (pk-pk of range)	3dB BANDWIDTH
100mA	100ppm	0.1Hz to 30kHz
100 nA to 10mA	100ppm	0.1Hz to 100 Hz
10 nA	200ppm	0.1Hz to 10 Hz
1 nA	400ppm	0.1Hz to 10 Hz

GUARD OUTPUT: Maximum Load Capacitance: 10nF. Maximum Load Current: Absolute total (Output+Guard) not to exceed 105mA. Accuracy: ±1mV (excluding output lead voltage drop).

PROGRAM MEMORY: Number of Locations: 100. Range of Dwell Times: 3ms to 999.9s. Accuracy of Dwell Time: ±(0.05% + 200µs).

OUTPUT LOAD: Output load must be non-inductive.

EXTERNAL TRIGGER: TTL-compatible EXTERNAL TRIGGER INPUT and OUTPUT.

OUTPUT CONNECTIONS: Teflon® insulated triax connector (Specialty Connector #30JR121-1) for output; five-way binding posts for GUARD OUTPUT COMMON and CHASSIS; BNC (chassis isolated) connectors for EXTERNAL TRIGGER INPUT and OUTPUT, Amphenol or Cinch Series 87 IEEE and printed circuit digital I/O port. All connections on rear panel.

### IEEE-488 BUS IMPLEMENTATION:

Multiline Commands: DCL, LLO, SDC, GET, GTL, UNT, UNL, SPE, SPD.

Uniline Commands: IFC, REN, EOI, SRQ, ATN.

Interface Functions: SH1, AH1, T6, TE0, L4, LE0, SR1, RL1, PP0, DC1, DT1, C0, E1.

Internal Programmable Parameters: DISPLAY MODE, OUTPUT, Prefix (Data Format), EOI, SRQ (including mask for over I-LIMIT or V-LIMIT), PROGRAM MODE, Range, Trigger Mode, Terminator Character, Inputs (SOURCE, I-LIMIT or V-LIMIT, DWELL TIME, 100-Point Memory Locations), Output Status, Digital Self Test.

Digital I/O Port: A separate I/O port consisting of four input and four output lines as well as common (IEEE-488) and +5VDC. Outputs will drive one TTL load. Inputs represent one TTL load. The 220 and 230 can be programmed to generate a "SRQ" upon any change in the four bit input data. Mating connector supplied.

### GENERAL

DISPLAY: 0.5" LED digits, 4½-digit signed mantissa, 1-digit signed exponent.

SYSTEMS COMPATIBILITY: IEEE-488-1978.

OVER LIMIT INDICATION: Model 220 (Voltage Limit): "V-LIMIT" LED will blink. Model 230 (Current Limit): "I-LIMIT" LED will blink.

### Model 230

RANGE	MAXIMUM OUTPUT	ACCURACY (1 YEAR) 18°-28°C	STEP SIZE	TEMPERATURE COEFFICIENT/°C 0°-18°C & 28°-50°C
100 V	±101.00 V	0.05 % + 50mV	50mV	0.005 % + 0.5mV
10 V	±19.995 V	0.05 % + 10mV	5mV	0.005 % + 100 µV
1 V	±1.9995 V	0.05 % + 1mV	500 µV	0.005 % + 25 µV
100mV	±199.9 mV	0.075 % + 300 µV	50 µV	0.01 % + 25 µV

MAXIMUM CURRENT LIMIT: ±100mA (-0, +20%).

SELECTABLE CURRENT LIMIT: ±100mA, ±20mA, ±2mA (-0, +20%).

LINE REGULATION: Less than 0.01% for AC power line changes within specified limits.

NOISE: (150µV+50ppm range) p-p, 0.1Hz to 300Hz; 5mV p-p, 0.1Hz to 300kHz. Specification applies for local sensing only.

RESPONSE TIME: Less than 3ms to within 0.1% of programmed change for Current Limit of at least 20mA.

TRANSIENT RECOVERY TIME: Less than 3ms to rated accuracy for Current Limit of at least 20mA.

OUTPUT IMPEDANCE:

SELECTED CURRENT LIMIT	OUTPUT IMPEDANCE
2mA	1mΩ + 10mH
20mA	1mΩ + 2mH
100mA	1mΩ + 1mH

SENSING: Rear panel switch selectable REMOTE and LOCAL SENSING.

REMOTE SENSING: Maximum lead drop: 0.5V. Maximum sense lead resistance: 5Ω. Specifications are per lead.

PROGRAM MEMORY: Number of Locations: 100. Range of Dwell Times: 3ms to 999.9s. Accuracy of dwell time: ±(0.05% + 200µs).

EXTERNAL TRIGGER: TTL-compatible EXTERNAL TRIGGER INPUT and OUTPUT.

OUTPUT CONNECTIONS: Five-way binding posts for OUTPUT, OUTPUT SENSE, COMMON, COMMON SENSE, CHASSIS and BNC (chassis isolated) connectors for EXTERNAL TRIGGER INPUT and OUTPUT. All connections on rear panel.

SELF-TEST: Digital RAM, ROM, optoisolators and front panel LEDs light up upon power ON.

WARMUP: 1 hour to rated accuracy.

POWER: 105-125 or 210-250VAC (internal switch selected), 50 or 60Hz, 60 watts maximum (80VA maximum). 90-105 or 180-210VAC operation available.

COOLING: Internal fan for forced air cooling.

ENVIRONMENTAL LIMITS: Operating: 0°-50°C; up to 35°C at 70% non-condensing relative humidity. Storage: -25° to 70°C.

DIMENSIONS, WEIGHT: 127mm high × 216mm wide × 359mm deep (5" × 8½" × 14¼"). Net weight 9 lbs. 11 oz. (4.39kg).

MAXIMUM ALLOWABLE COMMON MODE VOLTAGE (OUTPUT or OUTPUT COMMON to CHASSIS): 250V rms, DC to 60 Hz.

ACCESSORY SUPPLIED (Model 220): Model 6011: Triaxial Test Lead, 1m (3 ft.)

ACCESSORIES AVAILABLE:

Model 1019A: Universal Rack Mounting Kit

Model 1019S: Universal Slide Rack Mounting Kit

Model 6167: Guarded Adapter (for reducing effects of output cable capacitance)

Model 7008-3: IEEE-488 Cable (3 ft.)

Model 7008-6: IEEE-488 Cable (6 ft.)

Model 8001: Semiconductor Test Box

Model 8002: High Resistance Test Box

Model 8003: Low Resistance Test Box

# 225/Current Source

100pA—100mA Constant

- 3-dial settability from 100nA to 100mA
- Settable voltage compliance from 10V to 100V
- AC modulation input

The Keithley Model 225 is a true current source with full scale ranges of  $10^{-7}$  to  $10^{-1}$  A, capable of outputting currents from 100pA to 100mA. Resolution and stability are both within 0.02% for ranges of  $10^{-1}$  through  $10^{-6}$  A; the output is regulated to within  $\pm 0.05\%$  on the  $10^{-7}$  A range. This regulation can be maintained over the  $\pm 10$  V to  $\pm 100$  V compliance limits. Noise is less than 0.01% of full range.

Output current is adjusted using three calibrated in-line switches. A fourth in-line dial provides continuous adjustment with 0.02% resolution on each current range except  $10^{-7}$ .

The output voltage is determined by the voltage required to force the selected current through the device under test. The maximum output voltage is set by a front panel control. As this compliance voltage is exceeded, automatic crossover from current mode to voltage limiting protects the device connected to the input from voltage sensitive loads. A light on the front panel indicates operation in the voltage-limiting mode. When necessary, the 225 can be floated up to 500V off ground. Change in output current is only 5 ppm of full range per volt.

A modulation input may be used to modulate the current supplied by the 225 with a signal from 50Hz to 500Hz.

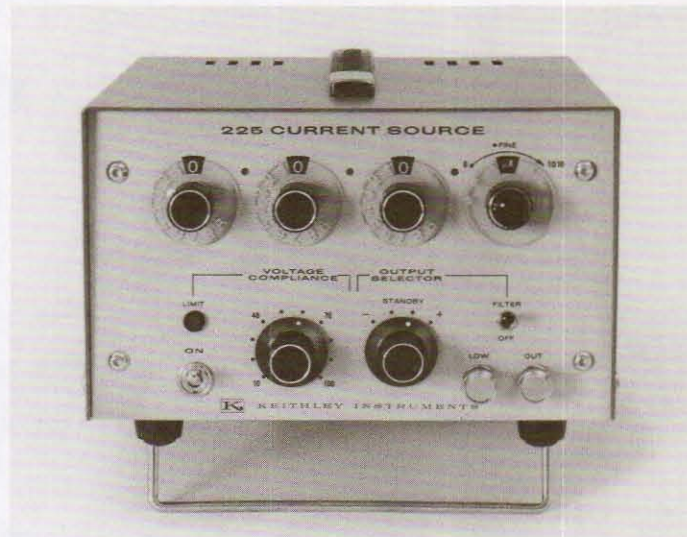

## OUTPUT:

**DC Current:**  $10^{-7}$  A full range to  $10^{-1}$  A in seven decade ranges, 3-digit in-line readout.

**Voltage:** 100V maximum. Compliance limit continuously variable from 10 to 100V.

**Polarity:** Positive or negative.

**Floating:**  $\pm 500$  V maximum off chassis ground, less than 5ppm of full range change in output current per volt.

**RESOLUTION:** Three significant figures from  $10^{-7}$  to  $10^{-1}$  A. "Trim" potentiometer permits 0.02% of full range or better resolution.

**ACCURACY:**  $\pm 0.5\%$  of reading,  $\pm 0.5\%$  of full range.

**STABILITY:**  $\pm 0.02\%$  of reading,  $\pm 0.005\%$  of full range on the  $10^{-1}$  to  $10^{-6}$  A range ( $\pm 0.1\%$  of reading,  $\pm 0.02\%$  of range on the  $10^{-7}$  A range) during the first hour or in subsequent 8-hour periods after a 1-hour warmup and at reasonably constant ambient temperature.

**NOISE:** Less than 0.01% rms of full range above 5Hz.

**LOAD REGULATION:**  $\pm 0.005\%$  of full range from no load to full load on the  $10^{-1}$  to  $10^{-6}$  A range,  $\pm 0.05\%$  on the  $10^{-7}$  A range (with FILTER "OFF").

**LINE REGULATION:**  $\pm 0.005\%$  of full range for 10% change in line voltage.

**OVERLOAD PROTECTION:** Voltage limited to compliance voltage setting of polarity selected. Automatic recovery from overload.

**MODULATION:** Transformer input permits modulation of current from 50Hz to 500Hz. Input impedance approximately 500 $\Omega$ .

**FILTER:** For operation with inductive loads up to 100 millihenries having greater than  $10^{-6}$  L/R ratio. Limits shunt output impedance to 1 $\mu$ F shunted by greater than  $10^{10}\Omega$ .

**ENVIRONMENT:** 50% relative humidity limit at 25°C.

**CONNECTORS:** Output (front and rear panels), BNC.

**POWER:** 105-125, 210-250V (switch selected), 50-60Hz, 25W.

**DIMENSIONS, WEIGHT:** 133mm (5 $\frac{1}{4}$ " ) half-rack, overall bench size 155mm high  $\times$  225mm wide  $\times$  310mm deep (6 $\frac{1}{4}$ "  $\times$  9"  $\times$  12 $\frac{1}{4}$ " ). Net weight, 4.2kg (10 lbs.).



- Up to 1A, 50W regulated output
- Current output is voltage programmable
- Optionally programmable range and compliance limit

The programmable Model 227 current source delivers accurate, stable, high-power constant current over full-scale ranges of 1 to 1000mA, with adjustable compliance voltage. The 3-digit in-line readout of the Model 227 enables the current output to be set to within 0.005% of range, with a full-range accuracy of 0.62%.

The 227 has a continuously adjustable compliance voltage limit, which can be easily set from approximately 3V to 300V on the 100mA and lower ranges. The 100mA range compliance is similarly adjustable from approximately 3V to 50V. This compliance voltage limit can be preset using the convenient front-panel meter as a guide. This meter also indicates current and voltage output levels under load.

Other features include excellent output current regulation, low output noise, low output capacitance (with correspondingly high output impedance at high frequencies), fast programming ability and a buffered rear-panel voltage monitor output.

The output current may be determined by the voltage applied to the VOLTAGE PROGRAMMING input; 10V corresponds to full range output.

Using the 2271 programming option, range and compliance limit may also be programmed, and current output may be programmed by a resistance or a voltage level. The option also includes a "compliance limit" flag.



The 227 has a true bipolar current output that can be modulated, allowing operation as a true AC constant current source. The output can be floated up to  $\pm 500$ V off chassis ground, with less than 5 ppm of full-range change in output current per volt off ground.

### AS A DC CONSTANT CURRENT SOURCE

#### OUTPUT:

**Current:**  $\pm 1\mu\text{A}$  (1000 $\mu\text{A}$  full range) to  $\pm 1000\text{mA}$  in four decade ranges; 3-digit in-line readout; 11% overrange to 1110.

**Voltage Compliance:**  $\pm 300\text{V}$  on 100mA range and lower;  $\pm 50\text{V}$  on 1000mA range. Compliance limit continuously adjustable from approximately 3V to full voltage compliance.

**Floating:**  $\pm 500\text{V}$  maximum off chassis ground, less than 5ppm of full range change in output current per volt.

**RESOLUTION:**  $\pm 0.005\%$  of range, 3-digit readout.

**ACCURACY:**  $\pm (0.5\%$  of setting,  $\pm 0.12\%$  of range).

### AS A BIPOLAR PROGRAMMABLE CONSTANT-CURRENT SOURCE/AMPLIFIER

**VOLTAGE PROGRAMMING (INPUT):** DC-coupled 0 to  $\pm 11\text{V}$ . Input resistance 10k $\Omega$ . Input must be isolated from output load by greater than 10 $\Omega$ .

**TRANSFER FUNCTION:**  $\pm 10\text{V}$  DC for  $\pm$ full range current output. Accuracy  $\pm 0.5\%$ . Zero offset less than 0.1% of range.

**BANDWIDTH (-3dB):** 600Hz minimum.

**OPTIONAL PROGRAMMING:** Model 2271 option permits remote programming of range, magnitude, polarity and compliance limit (see Model 2271).

### GENERAL

**STABILITY:**  $\pm (0.005\%$  of setting,  $\pm 0.005\%$  of range)/ $^{\circ}\text{C}$ . Short-term stability up to 30 days is masked by this temperature coefficient.

**LOAD REGULATION:**  $\pm 0.005\%$  of range from no load to full load.

**LINE REGULATION:**  $\pm 0.005\%$  of range for 10% change in line voltage.

**NOISE:** Wideband noise less than (0.03% of range + 2mV) rms above 5Hz.

**ENVIRONMENT: Operating:** 0 $^{\circ}\text{C}$  to 50 $^{\circ}\text{C}$ . 0% to 80% relative humidity up to 35 $^{\circ}\text{C}$ . Requires approximately 50mm (2 in.) top and 150mm (6 in.) rear panel clearances for air movement. **Storage:** -25 $^{\circ}\text{C}$  to +70 $^{\circ}\text{C}$ .

**CONNECTORS:** Output (front and rear), Voltage Programming Input (rear): Binding Posts.

**POWER:** 90-110, 105-125, 195-235, 210-250V (switch selected), 50-60Hz, 145W.

**DIMENSIONS, WEIGHT:** 133mm (5 $\frac{1}{4}$ " ) half-rack, overall bench size 145mm high  $\times$  220mm wide  $\times$  385mm deep (5 $\frac{3}{4}$ "  $\times$  8 $\frac{3}{4}$ "  $\times$  15 $\frac{1}{4}$ " ). Net weight, 10.9kg (24 lbs.).

### 2271 Specifications

**RANGE SELECT:** Closure\* on one of four lines selects range.

#### CURRENT SET:

**Voltage Programming:** Standard feature of Model 227. See Model 227 Specifications.

**Resistance Programming:** Transfer function: 10% of full range per k $\Omega$  ( $\pm 0.5\%$ ). Zero at approximately 11k $\Omega$ . Stability: adds  $\pm (0.01\%$  of setting + 0.01% of range)/ $^{\circ}\text{C}$  to Model 227 specification. Resistance must be isolated and shielded.

#### COMPLIANCE LIMIT:

**External Operate:** Closure\* enables external control of both span and limit. Open enables 227 front-panel control.

**Span Select:** Closure\* enables compliance limit to be set from 10 to 300V; open makes span 4 to 50V.

**Compliance Limit Set:** Resistance programmed, non-linear transfer function. 0  $\Omega$  yields high end of span, 25k $\Omega$  yields approximately mid span, open circuit yields low end. Resistance must be isolated and shielded.

**Flag (Output):** Logic "0" ( $\equiv$  less than 0.4V drop while sinking 16mA to external power supply LO) appears when 227 is in compliance limit. Logic "1" ( $\equiv$  greater than 2.4V at up to 400 $\mu\text{A}$  referenced to supply LO) appears when 227 is not in compliance limit.

#### REQUIRED CONTROL LEVELS:

\*CLOSURE  $\equiv$  Closure to external power supply LO within 0.5V while sinking 50mA (range-select for 1A range requires sinking 100mA).

OPEN  $\equiv$  greater than 2k $\Omega$  referenced to external power supply LO.

**EXTERNAL POWER SUPPLY:** Control requires external power supply of 5V to 6V at 200mA.

**CONNECTOR:** DAM-15S type mounts on 227 rear panel.

**ACCESSORY SUPPLIED:** Mating connector.

# 261/Source

## Bench Picoampere Source

- Output from  $10^{-14}$ A to  $1.1 \times 10^{-4}$ A
- $\pm 0.25\%$  accuracy at  $10^{-7}$ A,  $\pm 0.7\%$  at  $10 \times 10^{-12}$ A
- Secondary calibration standard

The Model 261 Picoampere Source is a secondary standard for calibration of picoammeters and electrometers. It is a "passive" source, consisting of a selectable 0 to 10V voltage in series with a specially selected and tested hi-meg resistor.

This circuit is designed for use in calibrating feedback picoammeters and electrometers in the FAST mode. Since there is no feedback loop controlling the output voltage, there will be no interaction between the source and the ammeter.

Current output is  $10^{-14}$ A to  $1.1 \times 10^{-4}$ A. Accuracy varies from  $\pm(0.25\% + 1 \text{ digit})$  on  $10^{-7}$  and higher ranges, to  $\pm(1.6\% + 1 \text{ digit})$  on the  $10^{-11}$  range. Long-term stability is better than  $\pm 0.15\%$  per month (typically  $\pm 0.05$  to  $\pm 0.1\%$  per month) on the most sensitive ranges, beyond 3 months after calibration. Calibration maintains stated accuracy for 3 months.

The instrument may also be used as a decade resistance standard, having  $\pm 0.02\%$  accuracy at  $10^5\Omega$ ,  $\pm 0.1\%$  accuracy at  $10^6$  and  $10^7\Omega$ , and  $\pm 0.5\%$  accuracy at  $10^8$  through  $10^{12}\Omega$ .

The characterization of the hi-meg resistors is based on a 10-year Keithley program of collecting data on these components, and on individual time stability measurements of each resistor.

A calibration certificate including range resistor values, temperature

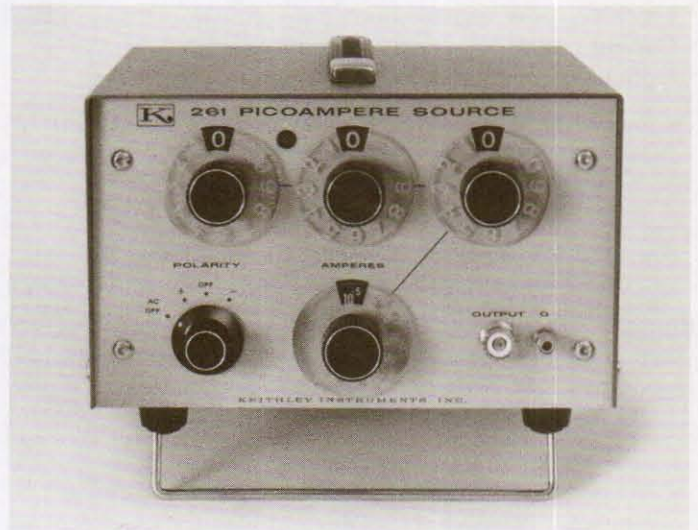

coefficients, and temperature and date of calibration is furnished with each Model 261. Certification traceable to the National Bureau of Standards and recalibration are also optionally available.

**OUTPUT:**  $10^{-14}$ A ( $10^{-11}$ A full range) to  $1.1 \times 10^{-4}$ A, positive or negative, in eight decade ranges.

**ACCURACY:** Exclusive of input drop consideration:

RANGE SETTING	SPAN, AMPERE	ACCURACY WITH 10.00 SETTING (10V SOURCE VOLTAGE)	WORST-CASE WITH SETTING OTHER THAN 10.00*
$10^{-7}$ to $10^{-5}$	$10^{-7}$ to $1.1 \times 10^{-4}$	$\pm 0.25\%$	$\pm 0.25\%$
$10^{-8}$	$10^{-8}$ to $10^{-7}$	$\pm 0.5\%$	$\pm 0.5\%$
$10^{-9}$	$10^{-9}$ to $10^{-8}$	$\pm 0.6\%$	$\pm 0.8\%$
$10^{-10}$	$10^{-10}$ to $10^{-9}$	$\pm 0.6\%$	$\pm 1.1\%$
$10^{-11}$	$10^{-11}$ to $10^{-10}$	$\pm 0.6\%$	$\pm 1.3\%$
$10^{-12}$	$10^{-12}$ to $10^{-11}$	$\pm 0.7\%$	$\pm 1.6\%$
$10^{-12}$	$10^{-14}$ to $10^{-12}$	—	$\pm 2.0\%$

\*All accuracies are plus or minus the percentage given,  $\pm 0.01$  times range switch setting.

**LONG-TERM STABILITY:** Will operate within stated specifications for three months after calibration. After three months add 0.15% per month to  $10^{-8}$  through  $10^{-12}$ A range setting accuracy specification.

**TEMPERATURE COEFFICIENT:**  $\pm 0.1\%/^{\circ}\text{C}$  from  $15^{\circ}\text{C}$  to  $30^{\circ}\text{C}$  on  $10^{-7}$  to  $10^{-5}$ A range settings. Approximately  $0.15\%/^{\circ}\text{C}$  on  $10^{-12}$  to  $10^{-8}$ A range settings. Exact value for these ranges supplied with instrument.

**WARM-UP TIME:** 1 hour.

**LINE REGULATION:** 0.0001% for 10% change in line voltage.

**SOURCE VOLTAGE:** 0 to 11V in 0.01V steps.

**RESOLUTION:** 3 significant figures from  $10^{-12}$ A to  $1.1 \times 10^{-4}$ A.

**RANGE RESISTORS:**  $10^5$  to  $10^{12}\Omega$  in decade steps;  $\pm 5\%$ .

**RANGE RESISTOR ACCURACY:** Value with power on, given on certificate:  
 $\pm 0.5\%$ :  $10^8$  to  $10^{12}\Omega$   
 $\pm 0.1\%$ :  $10^7$  to  $10^8\Omega$   
 $\pm 0.02\%$ :  $10^5\Omega$ .

**OUTPUT ISOLATION:** Low to ground; greater than  $10^9\Omega$  shunted by  $0.001\mu\text{F}$ .

**CERTIFICATION:** A Calibration Certificate is furnished including range resistor values, thermal coefficients, temperature and date of calibration. Certification traceable to the National Bureau of Standards is also available.

**POWER:** 105-125V or 210-250V (switch selected), 50-60 Hz, 6W.

**DIMENSIONS, WEIGHT:** Style P, 133mm ( $5\frac{1}{4}$ " ) half-rack, overall bench size 155mm high  $\times$  225mm wide  $\times$  305mm deep ( $6\frac{1}{4}$ "  $\times$  9"  $\times$  12"). Net weight 4.1kg (9 lbs.).

- High stability
- Excellent line and load regulation
- Bench or rack mounting

The Model 247 High Voltage Supply is a highly regulated 3000V DC, 6mA supply that complements the superior sensitivity characteristics of Keithley electrometers and picoammeters in applications such as photomultiplier tubes, resistivity testing, ion chambers and other nuclear detectors.

#### Output precision

The Model 247 has an output current of 6mA, sufficient to operate several devices at one time. The output stability of 0.01% per hour facilitates long term measurements. Any output voltage from 0 to 3000V may be set with 200mV resolution. The polarity reversal switch is particularly useful in resistivity testing.

#### Line regulation

Sensitive measurement will not be disturbed by fluctuating line voltage, due to superior line regulation. A 10% line change causes less than 0.001% output change.

#### Low noise

Low ripple and noise of 3mV p-p at 1kV, 1mA minimizes noise contribution to capacitive circuits such as ion chambers and resistivity cells.

#### Bench and rack mounting

The Model 247 is supplied with accessory mounting feet for bench applications. Rack mounting is accommodated by the 19" spaced holes in the front panel.



#### Solid state design

Long life and low maintenance costs can be anticipated from the 247 due to its all solid state design. Output circuitry is protected against arcs and short circuits.

#### OUTPUT:

Voltage: 0 to 3kV DC.

Current: 6mA DC maximum.

Polarity: Positive or negative with respect to chassis.

ACCURACY:  $\pm(0.25\%$  of setting + 1.5V DC) from 18° to 28°C.

RESOLUTION: Dial graduations of 200mV.

STABILITY:  $\pm 0.01\%$  of setting/hr.;  $\pm 0.02\%$  of setting/8 hrs, at constant temperature after 1/2 hour warmup.

TEMPERATURE COEFFICIENT:  $\pm 50\text{ppm}/^\circ\text{C}$  from 0° to 18°C and 28° to 50°C.

LINE REGULATION: 0.001% voltage change for  $\pm 10\%$  line variation.

LOAD REGULATION: 0.005% voltage change from no load to full load.

RIPPLE AND NOISE: 3.5mV rms, 10mV p-p @ 3kV, 6mA; 1mV rms, 3mV p-p @ 1kV, 1mA, 10Hz-100kHz.

SETTLING TIME: 4 seconds to within 1V with full resistive load.

OVERLOAD PROTECTION: Short circuit proof, arc protected, self restoring.

METER: Monitors voltage output.

ENVIRONMENT: Operating: 0° to 50°C, 0 to 80% relative humidity up to 35°C. Storage: -40° to 75°C.

CONNECTOR: Rear panel, MHV Type UG-931/U.

POWER: 90-125V/180-250V, 50-60Hz, 130VA.

DIMENSIONS, WEIGHT: 483mm wide  $\times$  89mm high  $\times$  273mm deep (19"  $\times$  3 1/2"  $\times$  10 3/4"), excluding handles. Four holes spaced for rack mounting. Net weight 5.9kg (13 lbs.).

ACCESSORIES FURNISHED: Mating connector, UG-932/U; mounting feet for bench operation.

#### ACCESSORIES AVAILABLE:

Model 6104: Test Shield

Model 6105: Resistivity Chamber

# Accessories

## Rack Mount Kits

Keithley rack mounting kits contain instructions and all hardware necessary for mounting many Keithley products in a standard 19" systems cabinet such as Keithley's Model 8000. Described below are the wide range of kits available and the various instruments that fit each kit. Shelf-type racks include a base plate for the mounted instrument(s); other kits are side-mounted and attach the instrument to the side of the rack. Dimensions shown are for the assembled kit and, unless otherwise noted, do not include dimensions of the mounted instruments.

INSTRUMENT MODEL NUMBER	SINGLE RACK MOUNT	DUAL RACK MOUNT	TYPE OF MOUNT
169 thru 179A	1010	1017	Shelf
181	1019A or 1019S	1019A or 1019S	(A) Fixed/(S) Sliding shelf
191	1010	1017	Shelf
192	1019A or 1019S	1019A or 1019S	(A) Fixed/(S) Sliding shelf
195	1019A or 1019S	1019A or 1019S	(A) Fixed/(S) Sliding shelf
220	1019A or 1019S	1019A or 1019S	(A) Fixed/(S) Sliding shelf
225	4003A	—	Side
230	1019A or 1019S	1019A or 1019S	(A) Fixed/(S) Sliding shelf
260/261	4003A	—	Side
410A/414S	4003A	—	Side
427	2000	—	Side
480	1010	1017	Shelf
616/6162	2000	—	Side
619	1019A or 1019S	—	(A) Fixed/(S) Sliding shelf
642	2000	—	Side
703	—	—	Supplied w/rack mtg. ears
705	1019A or 1019S	1019A or 1019S	(A) Fixed/(S) Sliding shelf
26000	4003A	—	Side

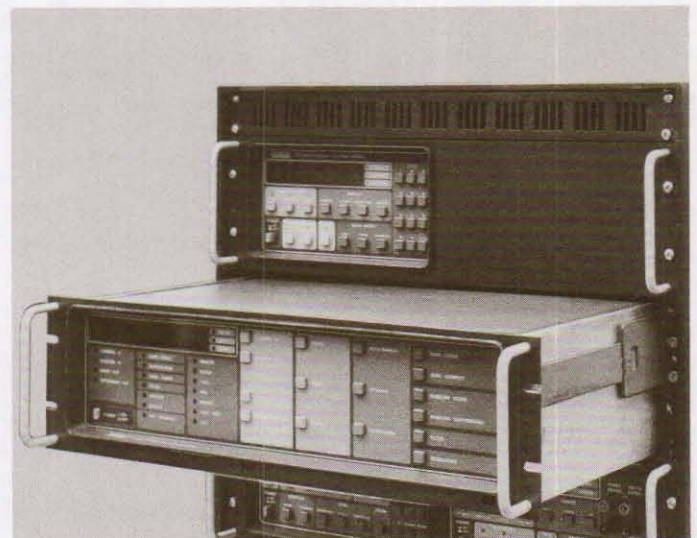
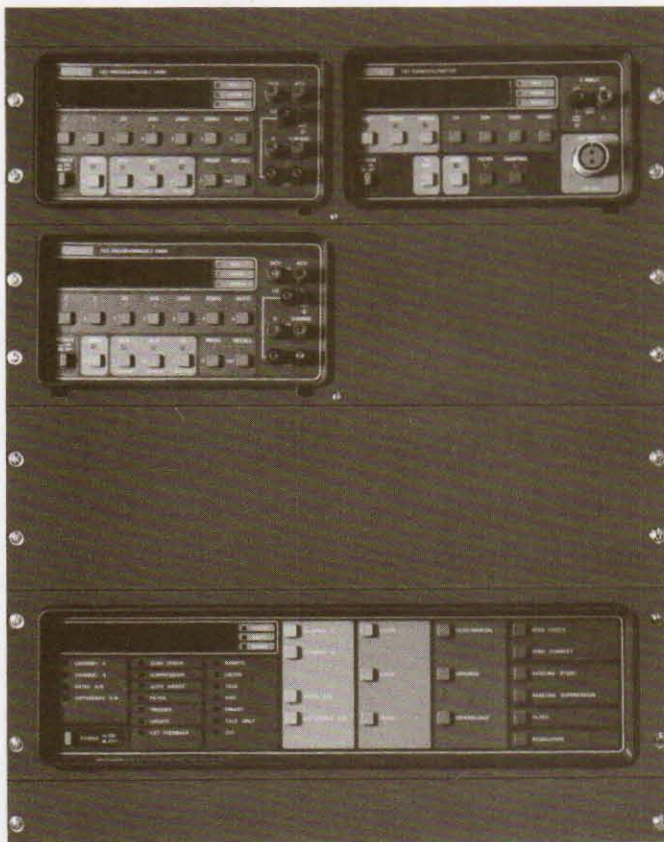

\*NOTE: Models 1019A (fixed) and 1019S (slide) rack mounting kits include both reversible single (top, on 1019A) and double (below, on 1019S) front dress panels. (1019S is shown partially extended.)

Model 1019A is a fixed or stationary rack mounting kit. Two front panels are provided to enable either single or dual side-by-side mounting of instruments shown in chart above.

**DIMENSIONS:** 5.2" high × 19" wide × 17.4" deep (132mm × 483mm × 442mm).

Model 1019S is a sliding rack mount kit. Two front panels are provided to enable either single or dual side-by-side mounting of instruments shown in chart above.

**DIMENSIONS:** 5.2" high × 19" wide × 20" deep (closed)/41" deep (open) (132mm × 483mm × 508mm/1041mm).

# Accessories

## Rack Mount Kits

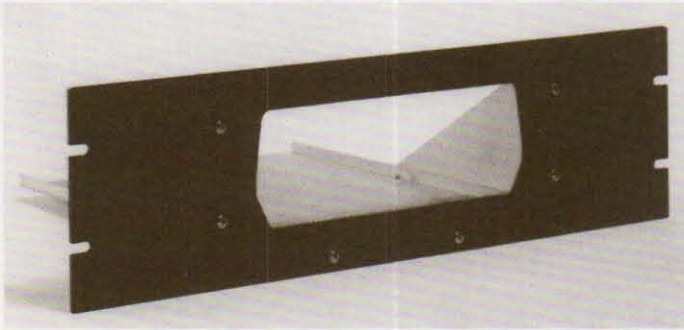

Model 1010 is a shelf-type kit for mounting any one Keithley bench DMM, including Models 169, 177, 179A, 191 and 480 Picoammeter. **DIMENSIONS:** 5.2" high  $\times$  19" wide  $\times$  10" deep (132mm  $\times$  483mm  $\times$  254mm).

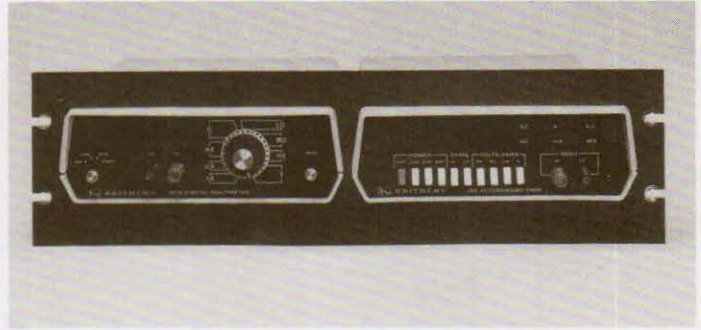

Model 1017 is similar to Model 1010 but provides for two Keithley bench DMMs. **DIMENSIONS:** 5.2" high  $\times$  19" wide  $\times$  9.9" deep (132mm  $\times$  483mm  $\times$  251mm).

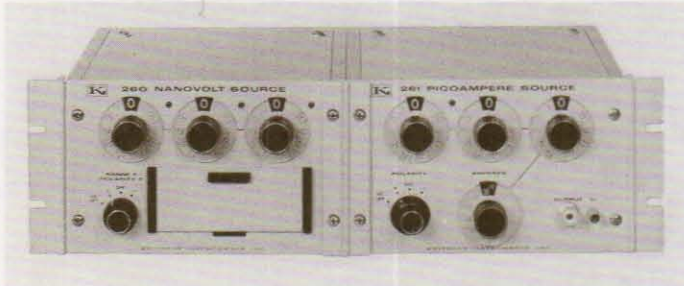

Models 4003A is a single side-mounted kit used to mount Models 225, 261 and 26000 series. **DIMENSIONS (including mounted instruments):** 5.25" high  $\times$  19" wide  $\times$  12.75" deep (133mm  $\times$  483mm  $\times$  311mm).

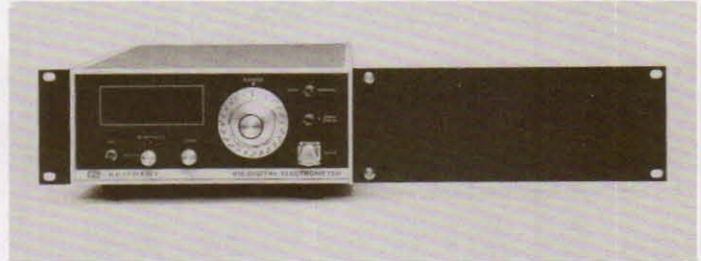

Model 2000 enables single rack mounting for Models 427, 616, 6162, 642 and 702, and includes a cover plate for the open area. **DIMENSIONS (including mounted instrument):** 3.5" high  $\times$  19" wide  $\times$  15.75" deep (89mm  $\times$  483mm  $\times$  400mm).

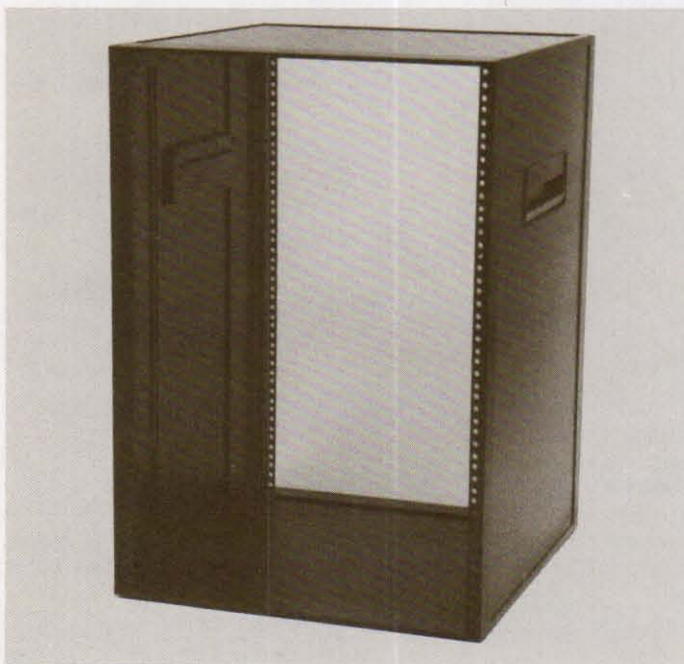

Model 8000 is a cabinet that will hold several instruments and is open on both ends with no rear panel supplied. It will accept all Keithley rack mounting kits as well as most other rack kits provided with other instrumentation. The cabinet is dark brown in color with handles permanently installed, one on each side. The cabinet is supplied assembled with 100 chrome Philip's head screws with mylar washers and clip nuts for instrument mounting. Rack mounting kits are available separately.

# Accessories

1301 - 1486

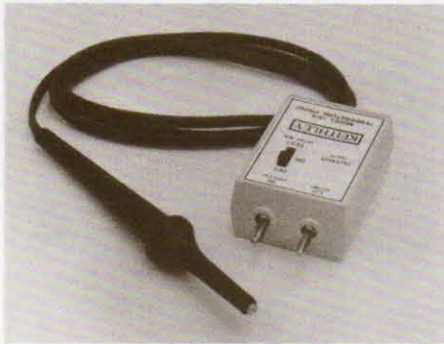

**Model 1301 Temperature Probe**

Range:  $-55^{\circ}\text{C}$  to  $150^{\circ}\text{C}$ .

Output:  $1\text{mV}/^{\circ}\text{C}$ ; compatible with any DMM with at least  $10\text{M}\Omega$  input impedance.

Accuracy:  $\pm 2^{\circ}\text{C}$  from  $0^{\circ}$  to  $100^{\circ}\text{C}$ ;  $\pm 3^{\circ}\text{C}$  from  $-55^{\circ}$  to  $0^{\circ}\text{C}$  and  $100^{\circ}$  to  $150^{\circ}\text{C}$ .

Power: 9V alkaline or C-Zn (NEDA 1604) battery.



**Model 1304 Soft Carrying Case & Stand:**

Padded soft vinyl carrying case and stand for one handheld meter and test leads.



**Model 1306 Heavy Duty Carrying Case:**

Padded leatherette case for all handheld meters; includes storage compartment for test leads and small accessories, hold-down strap for instrument, built-in tilt stand.

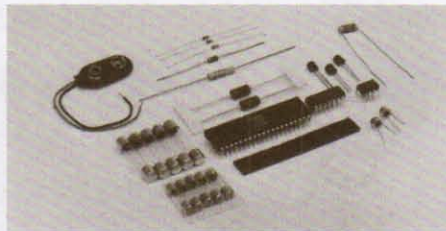

**Model 1309:** Contains spare parts for Model 130 and/or 131.

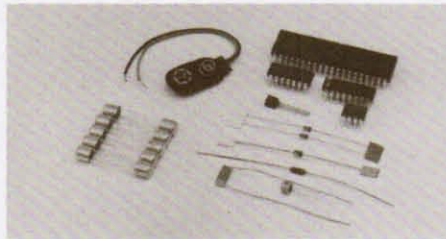

**Model 1359:** Contains spare parts for Model 135A.



**Model 1481 Low Thermal Input Cable:** 1.2m (4 ft.) of coaxial cable terminated on one end with Model 1486 (mating connector to Models 148 and 181) and two alligator clips on the other. Useful for making the best temporary connections in low voltage circuits.



**Model 1482 Low Thermal Input Cable:** Similar to Model 1481; 3m (10 ft.) of cable terminated with a mating connector and bare copper leads, allowing the user to make his own special low thermal input connectors to Models 148 and 181.



**Model 1483 Low Thermal Connection Kit:**

Contains crimp tool, pure copper lugs, alligator clips, low-thermal cadmium solder (10 ft.) and assorted hardware.



**Model 1484 Refill Kit:** Contains replacement parts for Model 1483 kit, including lugs, clips, solder and hardware.

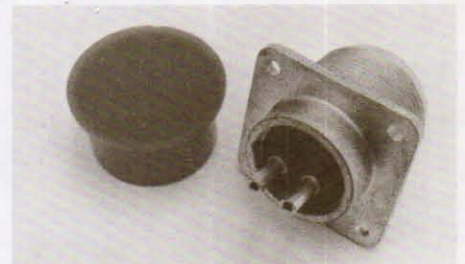

**Model 1485 Female Low-Thermal Input Connector:** For Models 148 and 181.



**Model 1486 Male Low-Thermal Connector:** Mates with the input connector for Models 148 and 181. Allows the user to make a custom length input cable.



**Model 1488 Low-Thermal Shorting Plug:** For checking proper operation and for calibrating Models 148 and 181. Special construction minimizes errors caused by thermal EMFs.

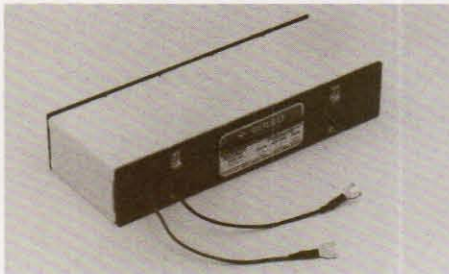

**Model 1489 Battery Pack:** Replacement nickel-cadmium battery pack for Model 148.



**Model 1503 Low Thermal Solder and Flux:** Low thermal cadmium tin solder and 4 oz. flux for connections to low voltage circuits.



**Model 1506 Input Cable:** 1.2m (4 ft.) triaxial cable with a low thermal mating connector to Model 181 on one end and two copper alligator clips on the other.



**Model 1507:** Similar to Model 1506; terminated with copper spade lugs.



**Model 1600A High Voltage Probe (DMMs)**  
**Maximum Input:** 40kV DC or peak AC to 300Hz.  
**Input Resistance:** 1000M $\Omega$ .  
**Division Ratio:** 1000:1 (into 10M $\Omega$ ).  
**Ratio Accuracy (into 10M $\Omega$  DMM):**  $\pm 2.5\%$  from 1kV to 40kV DC; -3dB at 300Hz AC.  
**Operating Temperature:** 0° to 50°C.

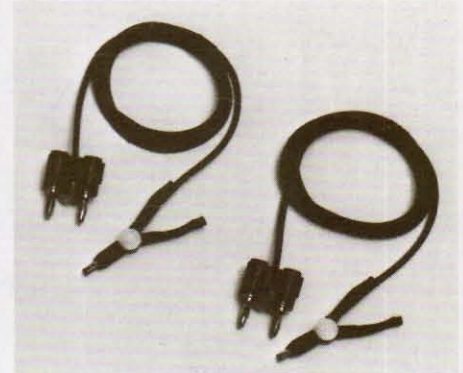

**Model 1641 Kelvin Test Lead Set:** Special clip leads allow 4-terminal measurements while making only 2 connections.



**Model 1651 50 Ampere Shunt:** External 0.001 $\Omega$   $\pm 1\%$ , 4 terminal shunt, extends current measuring capability of Keithley DMMs to 50A.



**Model 1681 Clip-On Test Lead Set:** Two 1.2m (48 in.) leads terminated with banana plug and spring-action clip-on probe.



**Model 1682A RF Probe (DMMs)**  
**AC to DC Transfer Accuracy:**  $\pm 1$ dB from 100kHz to 250MHz at 1V, peak responding, calibrated in rms of a sine wave, compatible with instruments with 10M $\Omega$  input resistance.  
**Voltage Range:** 0.25V to 15V rms.  
**Maximum Allowable Input:** 42V AC peak, 200V (DC + AC peak).

# Accessories

1683 - 1919

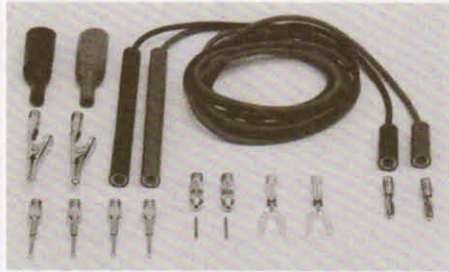

**Model 1683 Universal Test Lead Kit:** Two 1m (40 in.) test leads with 14 screw-in tips: 2 alligator clips, 4 banana plugs, 4 probe tips, 2 spade lugs, 2 phone tips.



**Model 1684 Hard Shell Carrying Case:** Hard vinyl case, 100mm × 350mm (4" × 13" × 14") has fitted foam insert with room for bench-size DMM, instruction book and small accessories.



**Model 1685 Clamp-On AC Probe (DMMs)**  
 Range: 2, 20 and 200A rms.  
 Accuracy: ±4% of range at 60Hz; ±6% of range at 50Hz.  
 Temperature Coefficient: ±0.05%/°C on 20A and 200A ranges; ±0.3%/°C on 2A range.  
 Maximum Allowable Current: 300A rms.  
 Maximum Conductor Voltage: 600V rms.  
 Conversion Ratio: 0.1V/A rms.



**Model 1691 General Purpose Test Lead Set:** Two 0.9m (36 in.) test leads with probe tips. Banana connection to DMM.

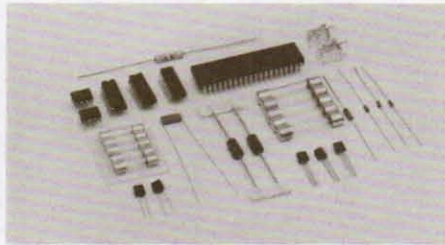

**Model 1699:** Contains spare parts for Model 169.

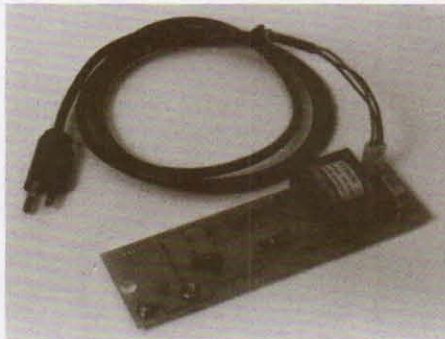

**Model 1766 Battery Eliminator:** Converts Model 169 to line cord operation. 105V AC to 250V AC; 10VA max.; 50Hz or 60Hz; 1/32 A Slo Blo fuse (250V). 0.45kg (1 lb.). Field installable.

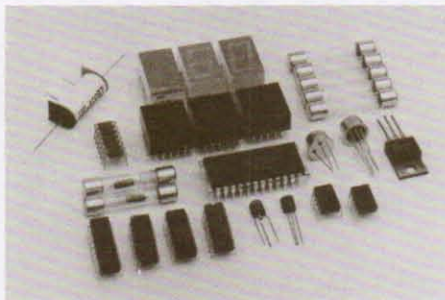

**Model 1779:** Contains spare parts for Model 177.

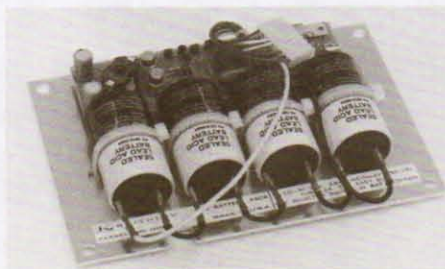

**Model 1788 Rechargeable Battery Pack:** 6 hours minimum operation from full charge, recharges within 14 hours. Field installable. Adds 0.9kg (2 lbs.) to 177, 179A and 480.



**Model 1796:** 10 ft. unterminated 26 lead mating cable to Model 1792 BCD output.

**Model 1815 Maintenance Kit:** Contains a calibration cover and two extender cables. The cover stabilizes internal temperature and the cables permit easy access to PC boards when calibrating Model 181.



**Model 1913 Calibration Cover:** Installed in place of normal top cover when calibrating Model 191. The cover helps stabilize internal temperature and has marked openings for calibration adjustments.

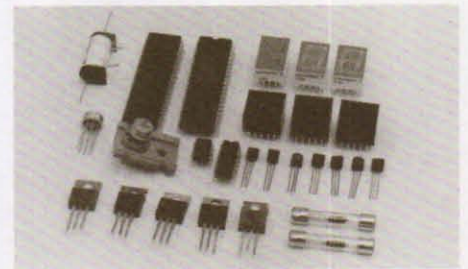

**Model 1919:** Contains spare parts for Model 191.



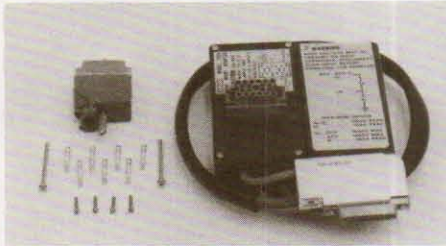

**Model 1924 Rear Input Adapter:** Provides multiple and single rear inputs on Model 192 DMM. The 192 must have the IEEE option to adapt to the 1924.



**Model 2503 Static Detector Probe:** Designed to detect voltage due to charge on relatively small surface areas. Solid coaxial 13mm (1/2 in.) diameter tube used with 89mm (3 1/2 in.) head, 89mm (3 1/2 in.) coupler, 25mm (1 in.) adapter and two 90° angle adapters which may be placed at various junctions along the tube. It gives a 10,000:1 ±10% division ratio when used with Model 610C and held 6mm (1/4 in.) away from a charged plane of at least 13mm (1/2 in.) diameter. Output is a UHF male plug.

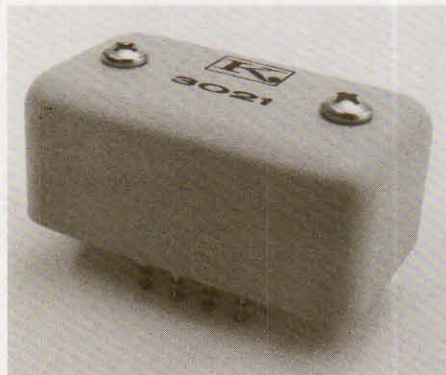

**Model 3021 Accessory Socket:** Permits quick connections to Model 302. The socket has plated terminals which are easily soldered. The 3021 provides a rigid shielded enclosure to minimize noise pickup.



**Model 4801 Input Cable:** Low-noise coaxial cable, 48 in. (1.2m) in length, with male BNC to male BNC connectors. For use with Model 480.



**Model 4803 Low Noise Cable Kit:** Includes 50' of low-noise coaxial cable, 10 male BNC connectors and 5 female BNC chassis-mount connectors.



**Model 6011:** 3 feet of triaxial cable (SC-22) terminated with a triax plug on one end and 3 alligator clips on the other. For use with Models 220, 602, 614, 616 and 619.

**Model 6011-10:** Same as Model 6011 except 10 ft. long.



**Model 6012 Triax to UHF Adapter:** Permits using Models 220, 602, 614, 616 and 619 with all Keithley electrometer accessories having UHF type connectors.

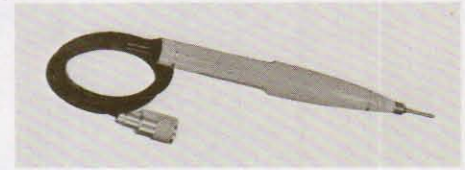

**Model 6101A Shielded Test Lead:** Straight through probe and shielded lead with 0.8m (30") of shielded low noise cable terminated by Teflon-insulated UHF connector. Use with 6012 adapter for Models 602, 614, 616 and 619.



**Model 6103C Voltage Divider Probe:** Permits voltage measurement to 30kV and has a 1000:1 division ratio. Accuracy is ±5% of reading. Its  $4.5 \times 10^{11} \Omega$  input resistance permits use with Keithley electrometers and other high impedance multimeters. Connector is a UHF male plug. Requires the 6012 Coaxial to Triaxial Adapter when used with Models 602, 614, 616 and 619. Lead length is 0.8m (30 in.).

# Accessories

6104 - 6421



**Model 6104 Test Shield:** Facilitates resistance, current or voltage measurements with either 2- or 3-terminal guarded connections. Voltages up to 1200V may be used. Provides excellent electrostatic shielding, high isolation resistance and a means for easy connection to most Keithley electrometers and power supplies. Clips plug into banana jacks, allowing the user to fashion modified connections. BNC connector on one side, binding posts on the other.



**Model 6105 Resistivity Chamber:** Guarded test fixture for measuring volume and surface resistivities. Assures good electrostatic shielding and high insulation resistance. Designed for use with Keithley voltage supplies and picoammeters, such as Models 247 and 480. The complete system permits direct measurement of volume resistivity up to  $10^9 \Omega/\text{cm}$  (on samples 0.1cm thick) and surface resistivity up to  $10^{18} \Omega$  in accordance with ASTM procedures. Sheet samples 64 to 102mm ( $2\frac{1}{2}'' \times 4''$ ) in diameter and up to 6.4mm ( $\frac{1}{4}''$ ) in thickness can be accommodated. Excitation voltages up to 1000V may be used.

The shielded Model 6105 provides a means of maintaining good sample contact with a uniform 1 pound pressure on smooth parallel-surfaced samples. An inter-

lock switch automatically disconnects the excitation voltage upon opening the lid.

**Supplied Accessories:**

- 1 Model 32418 UHF to MHV cable (to Model 247)
- 1 Model 4801 BNC to BNC cable (to Model 480)
- 1 Model 6147 BNC to triax adapter to allow use of Model 602, 614 or 616 in place of 480.
- 1 CS-115 UHF to BNC adaptor to allow use of Model 610C in place of 480.

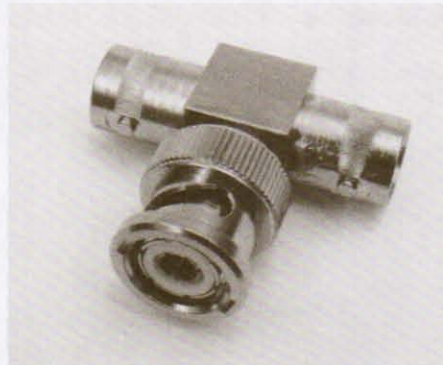

**Model 6146 Triax Tee Adapter:** To connect multiple inputs to Model 602, 614, 616 and 619; allows easy connection of external feedback elements.



**Model 6147 Triax to BNC Adapter:** Permits using Models 220, 602, 614, 616 and 619 with accessories having BNC connectors.

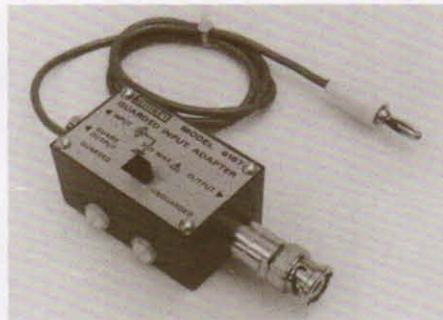

**Model 6167 Guarded Input Adapter:** Reduces effective cable capacity by driving the inner shield of the triaxial cable at Guard potential. For use with Models 220, 614 and 616. Triax female to triax male.

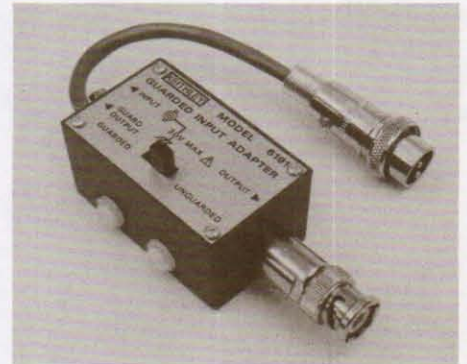

**Model 6191 Guarded Input Adapter:** Similar to the Model 6167 except that it is for use with a Model 619 electrometer module. Triax female to triax male.

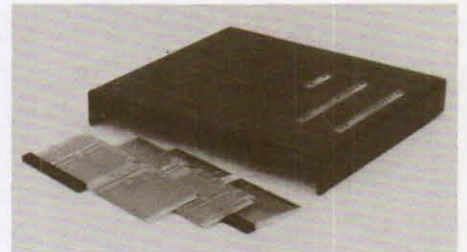

**Model 6195 Maintenance Kit:** For Model 619 electrometer/multimeter; includes calibration cover and three extender boards. Calibration cover allows the 619 to reach normal internal operating temperatures, and has adjustment openings marked to facilitate calibration adjustments. Three extender cards allow easy access to internal boards for troubleshooting.

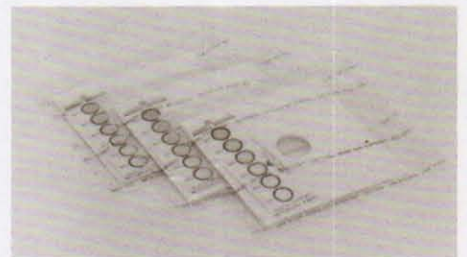

**Model 6421:** Refill dessicant paper pack for Model 642. One piece at a time may be installed in the remote head as needed. Each of the three pieces is individually packaged in its own moisture resistant bag.



**Model 6424:** BNC adapter for use with the 642. It is the most convenient connection method, limited by currents generated in the flexible cabling.



**Model 6427-10:** 10 ft. remote head to main-frame interconnect cable for Model 642.

**Model 6427-50:** 50 ft. remote head to main-frame interconnect cable with remote power supply for Model 642.



**Model 7010 Shielded IEEE to IEEE Adapter:** For use with System Components. Provides additional clearance between IEEE cable and rear panel, allowing easier access to switches, cables and other connectors near the IEEE connector.



**Model 6425:** Converts the input of Model 642 to a GR874® rigid air line connection, permitting decades of improvement in current resolution over Model 6424.

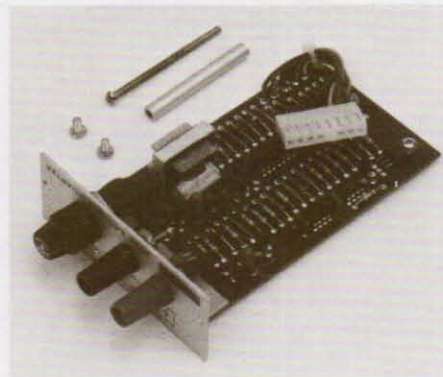

**Model 6428 Battery Adapter:** Permits operation of Model 642 from an external 12V battery.



**Model 7023 Female Triaxial Connector:** Chassis mount connector mates with Keithley accessory cables 6011 and 7024 series.

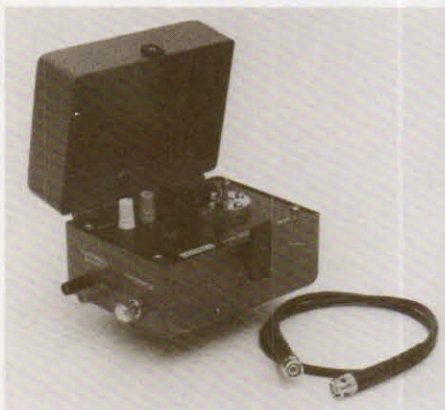

**Model 6426 Sapphire-Insulated Test Box:** Extends the integrity of the sapphire insulation into a test box which mounts on the remote head, when used with Model 642. The 6426 is useful for testing semiconductor leakage or high resistance measurements on small-geometry parts. Custom input fittings may be made to the dimensions indicated in the 642 Instruction Manual.



**Model 7008-3:** 0.9m (3 ft.) IEEE-488 digital cable terminated with a standard IEEE connector on each end, with metric mating screws.

**Model 7008-6:** 1.8m (6 ft.) IEEE-488 digital cable terminated with a standard IEEE connector on each end, with metric mating screws.



**Model 7024-1:** 0.3m (1 ft.) of triaxial cable (SC-22) with male triax connectors on both ends.

**Model 7024-3:** 0.9m (3 ft.) of triaxial cable (SC-22) with male triaxial connectors on each end.

**Model 7024-10:** 3.0m (10 ft.) of triaxial cable (SC-22) with male triaxial connectors on each end.

# Accessories

## 7051-1 - 8721; Miscellaneous



**Model 7051-2:** 2-foot BNC to BNC cable (RG-58C) for use with System Components.

**Model 7051-5:** 5-foot BNC to BNC cable (RG-58C) for use with System Components.

**Models 8001, 8002, 8003:** See page 10.



**Model 8660:** Tilt stand/belt clip/probe holder for use with Models 865, 866, 868 and 869 digital thermometers.

**Models 8661, 8662, 8663, 8664, 8665, 8666, 8668:** See page 43.

**Models 8693, 8694, 8695, 8696:** See page 45.



**Model 8700 Carrying Case:** Padded soft vinyl carrying case with belt clip, probe pocket and transparent cover, for one handheld meter and test leads or probe.

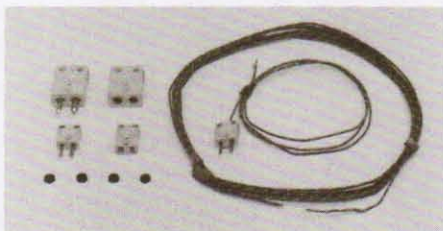

**Model 8711A Thermocouple Kit (Type K):** Includes Model 8712 Thermocouple Sensor, 6m (20') of AWG-24 Type K duplex TC wire, miniature TC plug and jack, standard TC plug and jack.

**Models 8712, 8713, 8714A, 8715, 8716, 8717:** See page 41.

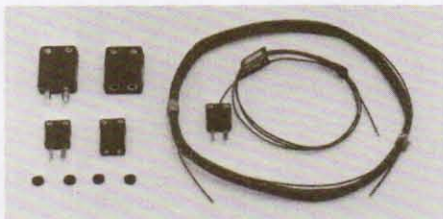

**Model 8721 Thermocouple Kit (Type J):** Includes Model 8722 Thermocouple Sensor, 6m (20') of AWG-24 Type J duplex TC wire, miniature TC plug and jack, standard TC plug and jack.

**Models 8722, 8723, 8725, 8726:** See page 41.

**19072 Input Cable:** 3 ft. of coaxial cable (SC-9) with a UHF connector on one end and alligator clips on the other. For use with Model 610C.

**32418:** UHF-MHV cable supplied with the Model 6105 for connection to Model 247.

**CA-18-1:** 4 ft. shielded cable terminated with a dual banana plug on each end. For use with System Components.



**CS-115 UHF-BNC Adapter:** Permits using Model 610C with accessories having BNC connectors.

**CS-141:** Male triax cable mount connector for use with SC-22 cable. Mates to Models 220, 602, 614, 616 and 619.

**SC-9:** Low noise coaxial cable without connectors (sold by the foot).

**SC-22:** Low-noise triaxial cable without connectors (sold by the foot).

# Service & Order Information

Instruments Division

The precision measurement instruments made by Keithley are widely recognized for the quality, performance and reliability they offer at affordable prices. We're proud of the recognition that our products have received. However, there's more to our success. We believe that our superior customer service has benefited our growth.

## Applications

For technical assistance with your specific needs and problems, contact our local sales representative or our in-house applications engineers.

## Manuals

Our Technical Manuals Department is dedicated to seeing that the customer is provided with the best possible information needed to operate and maintain Keithley products.

Each product is supplied with an instruction manual containing operating instructions, instrument specifications, performance verification procedures and descriptions of available optional accessories. Also included in the manual is such detailed information as theory of operation, troubleshooting and calibration procedures, schematics and component layouts, assisting a technician with repair and calibration of the instrument.

## Repair and Calibration Services

Keithley provides customers with the fastest possible repair service. Because our Keithley service department is geared to service only Keithley-manufactured equipment, shipping your instrument to our headquarters results in minimum downtime for you.

Keithley has expanded its in-warranty service organization to include regional service facilities. There are service centers located conveniently throughout the United States and Canada. These service centers were chosen for their ability to handle Keithley equipment and maintain the high standards that we've set for servicing our products.

If you have questions about whether your specific instrument repair should be sent to the Keithley factory or to a local service center, contact our Corporate Headquarters. All parts necessary to support Keithley's regional service centers are shipped directly from our Corporate facilities in Cleveland. Off-the-shelf parts are shipped to the service centers within 24 hours. Special orders are personally expedited to ensure minimum delivery time.

## Service Seminars

Keithley provides seminar training programs on troubleshooting your Keithley equipment. If you're interested in a seminar in your area, contact your local sales representative. If there is sufficient demand, we'll arrange one in your sales territory at a convenient time and place.

## Demonstrations

If your application requires that you evaluate an instrument before you purchase it, a hands-on demonstration can be arranged by contacting your local Keithley representative or Corporate Headquarters.

## Order Entry and Allocations

Each region of the country has a sales correspondent who is responsible for incoming orders and contact with sales representatives to satisfy individual customer needs.

Our allocations department is responsible for expediting orders and allocating finished goods. Parts orders are expedited through the repair department.

Keithley is committed to personalized service. Whatever your needs are, your requests will be handled quickly and efficiently by qualified Keithley personnel.

## Order and Quotation Information

### Pricing and Terms

Your local Keithley representative or distributor will gladly furnish price quotations and any details and particulars requested. Specifically, these guidelines apply to orders and quotations placed within the geographical areas outlined below. Customs and duties are not included in the price and are payable by the customer.

### United States and its Territories

**Prices:** All prices are F.O.B. Cleveland, Ohio. Transportation charges, insurance and special handling are extra.

**Terms:** 1/2% 10 days, net 30 days (subject to prior approval).

**Shipment:** Unless otherwise specified, goods will be sent collect via surface insured. Other shipping instructions will be followed on request.

**Minimum Order:** \$25.00.

### Canada, Asia and the Far East, Latin America, Australia, New Zealand and Southern Africa

**Prices:** Prices in these areas of the world are F.O.B. factory, Cleveland, Ohio and are slightly higher than U.S. prices. Forwarding, duties, transportation, insurance and other applicable fees are extra. C & F or CIF proforma invoices are available on request.

**Terms:** Available on request.

**Shipment:** Unless otherwise specified, goods will be sent collect via air insured. Other shipping instructions will be followed on request.

**Minimum Order:** \$25.00.

### Europe, North Africa and the Middle East

**Prices:** An exclusive price list is available on request. These prices are F.O.B. our warehouse in Geneva, Switzerland and are slightly higher than U.S. prices. Transportation from Geneva, insurance and other charges are extra. Consult your local representative.

**Terms:** Available on request.

**Shipment:** Goods will be sent collect via surface insured. Other shipping instructions will be followed on request.

**Minimum Order:** \$25.00.

## Where To Send Orders

### U.S.A. and other countries outside of Europe, North Africa and the Middle East

Send orders to your Keithley representative, distribution center or U.S. Corporate Headquarters.

### Europe, North Africa and the Middle East

Send orders to your Keithley representative or European Headquarters. The personnel at these locations will give prompt, competent and courteous service to your questions and requests.

Prices and specifications are subject to change without notice.

## Warranty

We warrant each of our products to be free from defects in material and workmanship. Our obligation under this warranty is to repair or replace any instrument or part thereof which, within a year of shipment, proves defective upon examination. We will pay local domestic surface freight costs.

To exercise this warranty, write or call your local Keithley representative, or contact Keithley headquarters in Cleveland, Ohio. You will be given prompt assistance and shipping instructions. (Note: This warranty does not cover battery replacement or damage caused by battery leakage.)

# Systems Division

## The Keithley Systems Concept: Performance, Service and Value

Keithley has become a name synonymous with leadership in the field of measurement technology. Keithley now sets the standard in wafer process monitoring with a family-oriented line of parametric test systems offering unmatched versatility, performance and value. Each Keithley parametric tester draws upon over a quarter century of experience in precision low-level measurement, an essential part of the ever-expanding semiconductor manufacture and test industry.

The Keithley Systems product line includes the field-proven System 300, the new System 250 and the second-generation Hall Effect System. Each represents a combination of hardware, software and capabilities which provides a unique solution to customer applications.

### KPT: Keeping pace with the future

A Keithley system represents an investment in the future, an era which many experts predict will be concerned as never before with the acquisition and management of information. This realization was a driving force in the development of Keithley's KPT Software Package, an integral part of the Systems concept. KPT offers a flexible approach to testing with provision for growth as the state of measurement technology progresses.

- **Productivity.** The KPT Software Package runs under the Digital Equipment Corporation RSX-11M operating system. RSX-11M and KPT provide a true multi-tasking, multi-user environment for Keithley test systems. This translates into greater wafer throughput as well as increased system availability for test programmers, data analysts and other system users.
- **Flexibility.** KPT gives the user a choice of approaches to parametric testing. Separate monitors for implementing task-oriented test plans or subroutine-oriented test plans enable the user to control software techniques, operator dialogue, throughput and other factors. Thus, the most effective method of testing can be selected for a given application.
- **Data management.** KPT offers complete data management facilities, including retrieval and analysis techniques to interpret test results. When wafer testing is completed, KPT's Lot Summary program formats and prints test data reports in a choice of formats. The Keithley Analysis Package (KAP) enables the user to apply standard statistical analyses (histograms, trend plots, scatter plots and wafer maps) to any portion of the data base.
- **Upward compatibility.** From the beginning, Keithley realized the rapidly-advancing nature of the semiconductor industry and set adaptability as one of the prime attributes of KPT. Structured design has assured KPT the ability to keep abreast of developments as the state of the art progresses. KPT's upward compatibility provides an important benefit to all users, since existing installations can generally be field-upgraded to incorporate the latest KPT software enhancements.

### System 300: Maximum versatility

Keithley's System 300 is designed with emphasis on flexibility and expandability. Configuration according to a user's specific requirements means that each 300 is virtually a custom-built system. As such, its design, performance and power can be tailored to handle the user's needs, including bipolar, MOS, production and research applications.

The System 300 provides complete DC forcing and measurement functions with accuracy typically better than 0.1%. The full-Kelvin, guarded switching matrix is expandable to 144 pins and 12 measurement nodes. With the optional Low-Current Matrix, Model 619 Systems Electrometer, and capacitance meter, the sensitivity and versatility of measurements can be extended.

The System 300 makes maximum use of KPT software, running multiple test stations with separate terminals for system management,



data analysis, software development and other operations. Data processing and system control are performed by a DEC PDP-11/23 minicomputer, with provision for the PDP-11/44 as an option. Mass storage is provided by RLO2 hard disk systems. A full line of printers, probers, plotters and other peripherals is available.

### System 250: Cost-effective design and uncompromised performance

In response to the needs of a considerable portion of the semiconductor industry, Keithley introduced the System 250. Through innovative design and the use of the latest mass storage techniques, the System 250 delivers the essentials of the System 300's performance at a lower price.

The System 250 is a two-test-station, 48-pin tester. In most respects, it shares the technology of the System 300, including use of KPT software. Measurements and forcing functions are performed with the same instrumentation, so its accuracy and precision are virtually identical to that of the System 300. Similarly, DEC's PDP-11/23 minicomputer is used for control and data processing.

A departure from the System 300 design is the use of a 31.2M byte Winchester hard disk drive and a 1M byte floppy disk drive for mass storage in place of RLO2s. The Winchester drive is remarkably compact, yet has the storage capacity of three RLO2 drives. Mounting of the disk drives, the CPU, and all instrumentation in a single system cabinet greatly reduces the floor space needed for the System 250, making it ideal where area is at a premium.

In keeping with its cost-conscious design, the System 250 is factory-configured as a "standard equipment" system capable of handling a majority of test applications. It is well-suited as the primary test system where cost is a prime concern. Or, as an addition to existing Keithley System installations, the System 250 can take advantage of KPT's network communication capability for file exchange with other Keithley systems. Either way, the System 250 provides traditional Keithley quality and performance at a substantial savings.

### Hall Effect System: A fully-tested system from one source

The Keithley Hall Effect System is designed for high-performance Hall Effect studies and electrical parameter measurements of wide band-gap semiconductor materials. It is a second-generation system using modular design and field-proven Keithley test instruments. The Hall Effect System uses electrometer amplifiers, special low-leakage relays in the switching matrix, and driven guards throughout to ensure an overall system input resistance above  $10^{13}\Omega$  in a laboratory environment. In addition, it is field-expandable; instruments, sources and peripherals can be added as they are needed. The system interface is via IEEE-488 bus connection for programming by an external computer, and Keithley offers selected models of the DEC PDP-11 minicomputer line for this purpose. Available peripherals include hard disk and 9-track tape sub-systems, printers, plotters and statistical subroutine software.

There are significant advantages to the purchase of a complete operational system from one source. The Keithley Hall Effect System is a complete, assembled and tested system delivered ready for use.

### Customer Support: Insurance for your investment

An intangible yet indispensable part of every Keithley Systems product is our complete commitment to customer support and satisfaction. Keithley Systems maintains field service, applications and repair facilities which are never further than a phone call away. Highlights of this program are:

- World-wide support, including on-site installation, check-out and training; and user training classes in Cleveland, Ohio and Sunnyvale, California.
- World-wide sales and service offices in major cities around the world, with manufacturing facilities in Cleveland and Munich, West Germany.
- Field service and applications organizations in Cleveland and Sunnyvale.

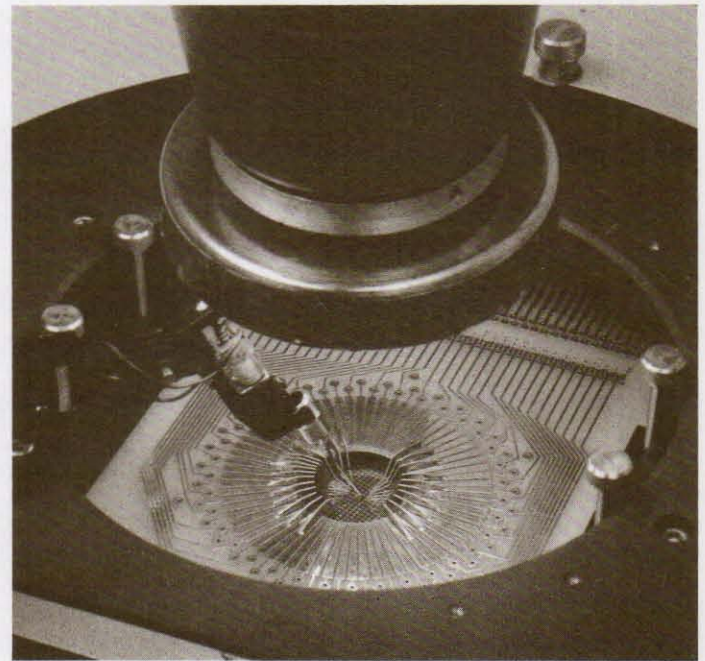

- Service contract programs for priority on-site service of systems after the warranty period.
- Factory repair facilities for fast-turnaround repair of instruments and circuit cards.
- Stocks of spare parts in Cleveland, Ohio, Sunnyvale, California, Munich, West Germany and Reading, England.

### Keithley Instruments: Commitment to leadership

Keithley Instruments has been an innovative force in the electrical measurement world for over 30 years. The Systems Division continues that commitment with leadership in parametric testing, and has been involved in semiconductor test instrumentation from the very beginning. We'll remain at the leading edge of semiconductor test technology because it is all we do, and we do it better than anyone else.

### Where to Find Us

For the local Keithley Systems Division representative nearest you, or for more information about products that interest you, please return the reply card at the back of this catalog or contact Keithley headquarters directly.

# Radiation Measurements Division

## Meeting the critical need for precision in radiation measurement.

In the growing field of radiation measurement there are two key requirements: exacting accuracy and long-term reliability. Whether the application is in diagnostic or therapeutic medicine, nuclear reactors, or related areas, high quality and maximum value are mandatory.

Our Keithley Radiation Measurements Division meets these tough standards with a full line of precision dosimeters, ion chambers, logarithmic picoammeters, exposure controls, and custom-designed high impedance devices. Many of these units are engineered to exact customer specifications, to satisfy a wide range of end-user needs.

In the medical area, Keithley instruments are typically used in calibration, field service and quality assurance testing of x-ray sources.

In addition, Keithley log-n-period amplifiers have been incorporated into many nuclear reactor monitoring and control systems—a key demonstration of our ability to meet stringent standards of accuracy and dependability.

And whatever the application, all of our radiation measurement systems rely on high impedance electrometer technology, an area where the Keithley name has become synonymous with quality, value, and reliability.

The Model 35614 Dosimeter System is one of the most versatile dosimeters available today for therapeutic radiology: its built-in, adjustable bias supply, rechargeable battery or line operation makes it a flexible research/clinical tool. The 35614 has a resolution of  $1 \times 10^{-13}C$  on the charge setting with a full-scale range of  $20 \times 10^{-6}C$  in three ranges. The Model 35614 joins the ranks of our other high-quality, affordable dosimeters: the 35050, our best-selling basic dosimeter, and the Model 35055—a portable, rechargeable model designed for demanding field applications. Both the 35050 and 35055 come complete with ion chambers with standard NBS traceable calibration. Additional calibration points are available on request.

The Radiation Measurements Division offers a line of high-quality, proven ion chambers. Keithley ion chambers are used for quality assurance testing, dosimetry and low intensity X-ray measurements, such as scatter radiation monitoring.

### Health Physics

Our customers have demanded our new Integrating Survey Meter Model 36150. The Model 36150 is now available along with our Model 36100 Survey Meter. The 36150 offers the same basic features of the 36100 with an exposure function in addition to the exposure rate function of the 36100. Support legs have been added for hands-free operation. The 36150 has a resolution of  $0.1\mu R$ . Both survey meters are used for health physics programs in clinical settings such as isotope storage areas and monitoring of isotope-implanted patients.

Our 26000 series Log Picoammeters are used for area monitoring at nuclear power generating and research facilities. These instruments are available (as the Model 26600) with an optional customer-installable bias supply and alarm trips. The bias supply is dual polarity, with a potential of 300V ( $\pm 5\%$ ). The alarm trips are available as a trip module and relay pair, with up to two trips installable in an instrument. Trip settings are HI trip, LO trip, and either latching or non-latching. The customer can select one of three full-scale meter ranges in steps of either 6 or 8 decades.

We make an X-ray Leakage Detection System used by X-ray tube manufacturers to test the integrity of X-ray tube heads. The system contains an array of special ion chambers which is rotated around the X-ray tube head to check for stray X-rays. If leakage radiation is detected, the signals generated by the ion chamber electrometer activate a trip circuit and visual display.

Keithley exposure controls provide X-ray machine manufacturers with accurate, automatic exposure timing for diagnostic X-ray equipment. Our ion chamber-electrometer modules are installed between the grid and film cassette for exposure determination in the film plane. Designed and constructed to offer minimal X-ray attenuation, they assure high-quality images which are virtually artifact-free.

### X-Ray Quality Assurance

The Radiation Measurements Division has two new products for non-invasive kVp measurements of X-ray machines: the Model 35070 kVp Meter and the 35080 kVp Divider. Both allow safe, accurate measurement of voltage applied to the X-ray tube, without disturbing high-voltage cables. The X-ray beam is differentially filtered before it reaches the sensing stage in the instrument. A ratio of the sensor readings from the heavily and lightly filtered beam areas is converted to a kVp signal. The 35070 provides a convenient, direct digital display of kVp; the 35080 outputs an analog waveform to a storage oscilloscope for detailed waveform analysis.

The Model 35065 Integrating Exposure Meter is convenience itself for quick-check evaluation of X-ray machine performance. The X-ray beam is collimated to the active area of the built-in ion chamber and an

## Dosimetry/Detection



36150 Integrating Survey Meter



35614 Dosimeter System



26600 Log Picoammeter



## Quality Assurance



35080 kVp Divider

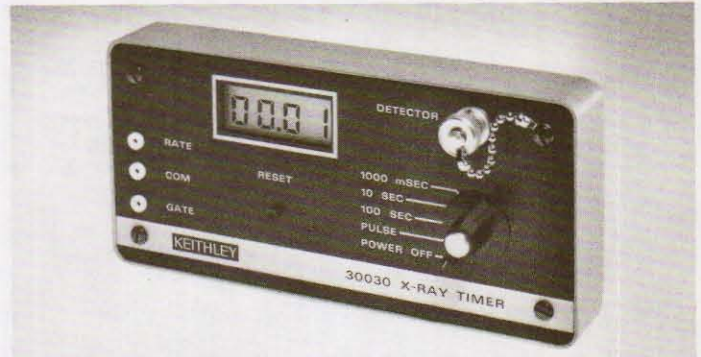

30030 X-ray Timer

exposure is made. The digital display reads out in milliroentgens in the exposure mode and roentgens/min in the exposure rate mode. A half-value layer filter kit, carrying case, data tablet and notebook are optional accessories.

### QA Test Accessories

We offer an extensive line of quality assurance test accessories for diagnostic and therapeutic radiology: water-filled therapy phantoms with Mylar® windows, SCRAD phantoms, fluoroscopic evaluation kits, and test stand to insure a standard ion chamber test geometry in the X-ray beam.

### Custom Instrumentation

During the early 1960s, an aerospace group evolved at Keithley Instruments in response to the need for sensitive radiation measure-

ment devices for the U.S. space program. The Company successfully met the challenge of this exacting application, and took pride in the knowledge that our Keithley-built equipment could handle the rigors of earth orbit. A spin-off of these efforts was the birth of the Radiation Measurements Division, along with extensive expertise useful to clinical and industrial users of radiation.

We continue to invite requests for custom instrumentation. And we can often tailor our existing instruments for special applications.

### Where to Find Us

For the local Keithley Radiation Measurements Division representative nearest you, or for more information about products that interest you, return the reply card at the back of this catalog or contact Keithley headquarters directly.



35070 Digital kVp Meter



# Model Number/Index

*128 Handheld Digital Multimeter	18	1485 Input Connector	.84	7029 Low Voltage Plug-In Card	.9
*130 Handheld Digital Multimeter	17	1486 Input Connector	.84	7051 BNC to BNC Cable	.90
*131 Handheld Digital Multimeter	17	1488 Shorting Plug	.85	7052 Matrix Plug-In Card	.5
*132C Handheld Digital Multimeter	20	1489 Battery Pack	.85	7053 Current Plug-In Card	.6
*132F Handheld Digital Multimeter	20			7054 High Voltage Plug-In Card	.6
*135A 4½-Digit Handheld Digital Multimeter	19	1503 Solder & Flux	.85	7055 Quick Disconnect Card	.7
148 Nanovoltmeter	.69	1506 Input Cable	.85	7056 Relay Plug-In Card	.6
155 Microvoltmeter/Null Detector	.72	1507 Input Cable	.85	7057A Thermocouple Plug-In Card	.7
*169 Portable/Bench Digital Multimeter	.22			7058 Low Current Plug-In Card	.8
177 Microvolt Digital Multimeter	.26	*1600A High Voltage Probe	.85	7059 Low Voltage Plug-In Card	.8
*179A TRMS Digital Multimeter	.24	*1641 Kelvin Test Leads	.85		
181 Digital Nanovoltmeter	.70	*1651 50-Ampere Shunt	.85	8000 Equipment Cabinet	.83
*191 5½-Digit Digital Multimeter	.28	*1681 Clip-On Test Leads	.85	8001 Semiconductor Test Fixture	.10
192 Programmable DMM	.30	*1682A RF Probe	.85	8002 High Resistance Test Fixture	.10
195 System DMM	.32	*1683 Universal Test Lead Kit	.86	8003 Low Resistance Test Fixture	.10
195T System DMM	.34	*1684 Carrying Case	.86		
		*1685 Clamp-On Current Probe	.86	*8660 Stand/Clip	.90
220 Programmable Current Source	.76	*1691 Test Leads	.86	*8661 Coiled Probe Cord	.43
225 Constant Current Source	.78	1699 Spare Parts Kit	.86	*8662 Thermistor	.43
227 Constant Current Source	.79			*8663 General Purpose Probe	.43
230 Programmable Voltage Source	.76	1766 Battery Eliminator	.86	*8664 Penetration Probe	.43
247 High Voltage Supply	.81	1779 Spare Parts Kit	.86	*8665 Surface Probe	.43
261 Picoampere Source	.80	1788 Battery Pack	.86	*8666 Air/Gas Probe	.43
		1796 Mating Cable	.86	*8668 Soft Carrying Case	.43
301 Electrometer Operational Amplifier	.64				
302 Electrometer Operational Amplifier	.64	1815 Maintenance Kit	.86	*8691 Accessory Kit	.45
				*8693 General Purpose Probe	.45
427 High Speed Current Amplifier	.60	1913 Calibration Cover	.86	*8694 Penetration Probe	.45
480 Digital Picoammeter	.61	1919 Spare Parts Kit	.86	*8695 Surface Probe	.45
		1924 Rear Input Adapter	.87	*8696 Air/Gas Probe	.45
602 Floating Electrometer	.58				
610C Line-Operated Electrometer	.59	2503 Static Detecting Probe	.87	*8700 Carrying Case	.90
614 Digital Electrometer	.54			*8711A Thermocouple Kit	.90
616 Autoranging Digital Electrometer	.56	3021 Shielded Socket	.87	*8712 Thermocouple Sensor	.41
619 Electrometer/Multimeter	.50			*8713 General Purpose Probe	.41
642 Digital Electrometer	.52	4003A Rack Mounting Kit	.83	*8714A Penetration Probe	.41
		4801 Input Cable	.87	*8715 Surface Probe	.41
703 Scanner	.9	4803 Cable Kit	.87	*8716 Air/Gas Probe	.41
705 Scanner	.4			*8717 Hypodermic Probe	.41
		6011 Input Leads	.87		
85 Computer	.11	6012 Triax-to-Coax Adapter	.87	*8721 Thermocouple Kit	.90
851 Disk Drive	.11			*8722 Thermocouple Sensor	.41
852 Plotter	.11	6101A Shielded Probe	.87	*8723 General Purpose Probe	.41
853 Printer	.11	6103C Voltage Divider Probe	.87	*8725 Surface Probe	.41
		6104 Test Fixture	.88	*8726 Air/Gas Probe	.41
*865 Handheld Digital Thermometer	.42	6105 Resistivity Chamber	.88		
*866 Handheld Digital Thermometer	.42	6146 Triax Tee Adapter	.88	18000-20 Picoammeter	.62
*868 Handheld Digital Thermometer	.44	6147 Triax to BNC Adapter	.88		
*869 Handheld Digital Thermometer	.44	6162 Isolated Output/Control	.57	26000 Logarithmic Picoammeter	.63
*871 Handheld Digital Thermometer	.40	6167 Input Adapter	.88		
*872 Handheld Digital Thermometer	.40	6191 Input Adapter	.88	DMM Selector Guide	.12
		6195 Maintenance Kit	.88	Electrometer/Picoammeter Selector Guide	.46
1010 Rack Mounting Kit	.83			Nanovoltmeter Selector Guide	.66
1017 Rack Mounting Kit	.83	6421 Dessicant Paper Refill	.88	Sources Selector Guide	.75
1019A Rack Mounting Kit	.82	6424 Input Adapter	.89		
1019S Rack Mounting Kit	.82	6425 Input Adapter	.89	DMM Accessories Selector Guide	.35
		6426 Test Box	.89	Electrometer/Picoammeter Accessories	
*1301 Temperature Probe	.84	6427 Interconnect Cable	.89	Selector Guide	.65
*1304 Carrying Case	.84	6428 Battery Adapter	.89	Nanovoltmeter Accessories Selector Guide	.74
*1306 Carrying Case	.84			Rack Mounting Kits	.82
1309 Spare Parts Kit	.84	7008 IEEE-488 Cable	.89		
1359 Spare Parts Kit	.84	7010 IEEE-488 Adapter	.89	Service And Order Information	.91
1481 Input Cable	.84	7023 Female Triaxial Connector	.89	Warranty Information	.91
1482 Input Cable	.84	7024 Triaxial Cable	.89	Customer Service Information	.91
1483 Connection Kit	.84	7026 Relay Plug-In Card	.9	European Representatives	.98
1484 Refill Kit	.84	7027 Thermocouple Plug-In Card	.9	International Representatives	.99
		7028 Low Current Plug-In Card	.9	U.S. Representatives	Inside Back Cover
				Distributor Representatives	.100

\*In stock at distributors throughout the U.S.

# Europe/Sales Representatives

## EUROPEAN HEADQUARTERS

**WEST GERMANY**  
Keithley Instruments GmbH  
Heiglhofstrasse 5  
8000 Munich 70  
Telephone: (089) 714-40-65  
Telex: 52-12160

## EUROPE

**AUSTRIA**  
Keithley Instruments GesmbH  
Döblinger Hauptstr. 32  
1190 Wien  
Telephone: 314 289  
Telex: 13-4500

## BELGIUM

Ets. Miravox S.A.  
Square Charles Wisser 12-13  
1040 Brussels  
Telephone: 02/73-54-173  
Telex: 25-579

## BULGARIA

Universal Elektronik Import  
Einsiedlerplatz 13  
1051 Wien-Austria  
Telephone: 54-15-88  
Telex: 11-5011

## CZECHOSLOVAKIA

Universal Elektronik Import  
Einsiedlerplatz 13  
1051 Wien-Austria  
Telephone: 54-15-88  
Telex: 11-5011

## DENMARK

SC Metric A/S  
Skodsborgvej 305  
2850 Naerum  
Telephone: 02/80-42-00  
Telex: 37-163

## EGYPT

Taco  
Tech. and Commercial Office  
14 B El-Gamhouria St.  
Cairo  
Telephone: 91-73-21  
Telex: 93-186

## FINLAND

Finn Metric OY  
Riihitontuntie 2  
P.O. Box 4  
02201 Espoo 20  
Telephone: 42-39-11  
Telex: 12-2018

## FRANCE

Keithley Instruments SARL  
2, bis, rue Léon Blum  
B.P. 60  
91121 Palaiseau Cedex  
Telephone: (6) 011-51-55  
Telex: 600-933

## GREECE

**ATE**  
American Tech. Enterprises SA  
48 Patision Street  
P.O. Box 156  
Athens  
Telephone: 88-11-271  
Telex: 21-60-46

## HUNGARY

Universal Elektronik Import  
Einsiedlerplatz 13  
1051 Wien-Austria  
Telephone: 54-15-88  
Telex: 11-5011

## ICELAND

Rafis H.F.  
Siomula 37  
P.O. Box 10055  
105 Reykjavik  
Telephone: 86-620  
Telex: 21-56

## IRAQ

**LABSCO**  
P.O. Box 1728  
6360 Friedberg  
Germany  
Telephone: 06031-144-55  
Telex: 41-59-97

## ISRAEL

**RACOM Electronics Co. Ltd.**  
7 Kehilat Saloniki Street  
P.O. Box 21120  
Tel Aviv 61210  
Telephone: 03/49-19-22  
Telex: 33-808

## ITALY

**Elettronucleonica S.P.A.**  
Piazza de Angeli 7  
20146 Milano  
Telephone: 02/49-82-451  
Telex: 33-20-33

## LEBANON

**Projects S.A.L.**  
P.O. Box 11-5281  
Beirut  
Telephone: 331-680  
Telex: 20-466

## NETHERLANDS

Keithley Instruments B.V.  
Arkelsedijk 4  
Postbus 559  
4200 An Gorinchem  
Telephone: 0 1830-25577  
Telex: 24-684

## NORWAY

Metric A/S  
Plogveien 1B  
Oslo 6  
Telephone: 02/28-26-24  
Telex: 18-461

## POLAND

Universal Elektronik Import  
Einsiedlerplatz 13  
1051 Wien-Austria  
Telephone: 54-15-88  
Telex: 75-011

## PORTUGAL

Emilio De Azevedo Campos  
Rua 31 De Janeiro 137-145  
Apartado 2018  
4019 Porto Codex  
Telephone: 02/20254  
Telex: 22-376

## QATAR

Laffan Trading & Con. Est.  
P.O. Box 6363  
Doha  
Telex: 32-97-36  
Telephone: 47-89

## RUMANIA

Universal Elektronik Import  
Einsiedlerplatz 13  
1051 Wien-Austria  
Telephone: 54-15-88  
Telex: 11-5011

## SPAIN

**PACISA**  
Ronda de Atocha 17  
P.O. Box 7023  
Madrid 5  
Telephone: 22-85-200  
Telex: 23-014

## SAUDI ARABIA

**SOMATCO**  
Saudi Overseas Marketing  
Trading Company  
King Faisal Street  
Mohanna Bldg. Flat 3  
P.O. Box 1951  
Riyadh  
Telephone: 40-25-727  
Telex: 20-1477

## SWEDEN

Scandia Metric AB  
Banvaktsvägen 20  
P.O. Box 1307  
17125 Solna 1  
Telephone: 08/82-04-00  
Telex: 10-766

## SWITZERLAND

Keithley Instruments SA  
(Filiale Zürich)  
Kriesbacherstr. 4  
8600 Dübendorf  
Telephone: 01/821-94-44  
Telex: 57-536

## TURKEY

Mevag  
Karaköy Bankalar  
Caddesi 71-73  
P.O. Box 143  
Istanbul  
Telephone: 43-52-40  
Telex: 24-539

## UNITED KINGDOM

Keithley Instruments Ltd.  
1, Boulton Road  
Reading, Berks, RG 2 0NL  
Telephone: (0734) 86-12-87/88  
Telex: 84-7047

## USSR

International Electronics Co.  
Schließmannsgasse 16  
P.O. Box 647  
1130 Wien-Austria  
Telephone: 85-93-04  
Telex: 13-2480

## YUGOSLAVIA

Belram S.A.  
83, Avenue des Mimosas  
1150 Brussels, 15-Belgium  
Telephone: 734-33-32  
Telex: 21-790

### Systems Division/Radiation Measurement Division

Sales offices listed represent Keithley Instruments Division only. To learn the name of the Systems or Radiation Measurement Division representative in your area, please contact:

**U.S. Headquarters**  
Keithley Instruments, Inc.  
28775 Aurora Road  
Cleveland, Ohio 44139  
Telephone: (216) 248-0400  
Telex: 98-5469

**European Headquarters**  
Keithley Instruments GmbH  
Heiglhofstrasse 5  
8000 Munich 70  
Telephone: (089) 714-40-65  
Telex: 52-12160

or use the reply cards located at the end of this catalog.

For European, North Africa and Middle East countries not listed contact:

**Keithley Instruments GmbH**  
Heiglhofstrasse 5  
8000 Munich 70  
Telephone: (089) 714-40-65  
Telex: 52-12160

# Sales Representatives/International

## NORTH AMERICA

### CANADA

**DigiDyne Inc.**  
785 Avenue Lajoie  
Dorval, Quebec  
Canada H9P 1G7  
Telephone: (514) 631-1891  
Telex: 05-823540

**DigiDyne Inc.**  
11630 Kingsway Ave.  
Edmonton, Alberta  
Canada T5G 0X5  
Telephone: (403) 454-1211  
Telex: 03742639

**DigiDyne Inc.**  
Suite 801  
275 Slater St.  
Ottawa, Ontario  
Canada K1P 5H9  
Telephone: (613) 232-8745  
Telex: 0534939

**DigiDyne Inc.**  
Mississauga Executive Ctr.  
2 Robert Speck Parkway  
Suite 750  
Mississauga, Ontario  
Canada L4Z 1H8  
Telephone: (416) 276-5060  
Telex: 06-960351

### MEXICO

**Mexitek, S.A.**  
Eugenia No. 408  
Depts. 2 y 3  
Apdo. Postal 12-1012  
México 12, D.F. México  
Telephone: (905) 536-09-10  
(905) 523-97-51  
Telex: 177-3239 MEXIME

**Christensen S.A.**  
Guillermo Prieto 76-304  
Col. San Rafael  
Delg. Cuanhthemoc  
06470 México, D.F. México  
Telephone: 546-29-55 &  
546-25-95  
Telex: 017-75612 MYCOME

## SOUTH AMERICA

### ARGENTINA

**Search S.A.**  
Corrientes 617  
6 Piso  
1043 Buenos Aires  
Argentina  
Telephone: 394-5882  
394-3312  
Telex: 24447 SEARH AR  
Cable: "SEARCH-B.A."

### BRAZIL

**Cosele Instrumentos  
Eletrônicos Ltda.**  
Rua da Consolacao,  
867-cj. 32  
01301 Sao Paulo, SP  
Brazil  
Telephone:  
Direct—(011) 256-7421  
(011) 231-5548  
PBX—(011) 255-1733  
Telex: 011-30869  
CSEL BR

## CHILE

**Interexport Ltda.**  
Galvez 83  
Casilla: 9269  
Santiago, Chile  
Telephone: 80335 & 85948  
Telex: 340496 INPORT CK

## COLOMBIA

**Telectrónica Ltda.**  
Avda. 40A No. 13-06 Piso 2  
Apartado Aéreo 29785  
Bogotá, D.E., Colombia  
Telephone: 245-6391/8478  
Telex: 45-173 IALAC CO  
Cable: ELECTRONICA

## ECUADOR

**Digitec, Compania Limitada**  
Isla Isabela y 6 de Diciembre  
Casilla 408-A, Sucursal No. 3  
Quito, Ecuador  
Telephone: 459761  
Telex: 2797 DIGTEC ED

## PERU

**BMP Ingenieros S.A.**  
Av. Arenales 395  
Of. 507-509  
Lima, Perú  
Telephone: 31-8060  
Telex: 25352 PE CP HCRIL

## VENEZUELA

**Equilab C.A.**  
Centro Sequros La Paz  
6° Piso, Locales E-61/N-62  
Avenida Francisco De Miranda  
Boleita  
Caracas 1070  
Apartado 60.497  
Caracas 1060-A  
Telephone: 36-45-33  
Telex: 21860 EQUIX  
Cable: "EQUILAB" Caracas

## ASIA-PACIFIC

### AUSTRALIA

**Scientific Devices Australia  
Pty. Ltd.**  
2 Jacks Road  
P.O. Box 63  
South Oakleigh, Victoria 3167  
Australia  
Telephone: 579-3622  
Telex: AA32742  
Cable: "DEVICES  
MELBOURNE"

**Scientific Devices Australia  
Pty. Ltd.**  
31 Halsey Road  
Elizabeth East 5112  
South Australia  
Telephone: 255-6575  
Telex: 88125

**Scientific Devices Australia  
Pty. Ltd.**  
35 Hume Street, Suite 2  
Crows Nest N.S.W. 2065  
Australia  
Telephone: 43-5015, 43-5016  
Telex: AA22978  
Cable "DEVICES SYDNEY"

## REPUBLIC OF CHINA

**Evergo Corporation**  
2nd Floor, 2, Lane 8  
Shin Chung Street  
P.O. Box 87-827  
Taipei 105, Taiwan, R.O.C.  
Telephone: (02) 769-9945  
Telex: 10548 EVERGOFT

## HONG KONG & PEOPLE'S REPUBLIC OF CHINA

**Electronic Scientific Eng. Ltd.**  
Seaview Commercial Bld. 3/F  
21-24 Connaught Rd., West  
Hong Kong  
Telephone: 5-487007  
Telex: 62118 ESENG HX  
Cable: "ELSCENG"

## INDIA

**Micronic Devices**  
104/109C, Nirmal  
Industrial Estate  
Sion East  
Bombay 400 022  
Telephone: 486170  
Telex: 011-71447 MDEV IN  
Cable: DATAPACING  
BOMBAY  
MATUNGA-400 022

**Micronic Devices**  
No. 65, Arun Complex  
D.V.G. Road  
Basavanagudi  
Bangalore 560 004  
Telephone: 600631  
Cable: DATAPACING  
BANGALORE-560 004

**Micronic Devices**  
R-694, New Rajendra Nagar  
New Delhi 110 060  
Telephone: 560423

## JAPAN

**Toyo Corporation**  
2,1-Chome, Hongoku-cho  
Nihonbashi, Chuo-ku  
Tokyo 103, Japan  
P.O. Box 5014  
Tokyo International,  
Tokyo 100-31, Japan  
Telephone: 03-279-0771  
Telex: 222-2973 TOYOCO J  
Cable: "SHININGEAST"  
Tokyo

**Toyo Corporation**  
Mitsui Seito Building  
8-7, Minami-Senba 2-chome  
Minami-ku, Osaka 542, Japan  
Telephone: 06-262-3471  
Telex: 522-2126  
Cable: "SHININGEAST"  
Osaka

**Toyo Corporation**  
7-3, Chuo-Cho  
Katsuta-shi  
Ibaraki-ken 312, Japan  
Telephone: 0292-73-3421  
Telex: 363-2444

**Toyo Corporation**  
Issha-Chuo Building  
263, 1-Chome, Takayashiro  
Meito-ku, Nagoya 465, Japan  
Telephone: 052-772-2971

**Toyo Corporation**  
2-9-40 Kitasaiwaicho  
Nishi-Ku  
Yokohama 220, Japan  
Telephone: 045-314-078

## KOREA

**Shin Han Scientific Co. Ltd.**  
12th Fl., Baikho Building  
1, 1-Ka, Euijuro, Choong-Ku  
Seoul, Korea  
C.P.O. Box 1250  
Telephone: 744-9111,  
744-9311  
Telex: K28205 SHINHAN  
Cable: "ASIASCIENC"-Seoul

## NEW ZEALAND

**G.T.S. Engineering Ltd.**  
52 Broadway, Newmarket  
P.O. Box 9613, Auckland  
New Zealand  
Telephone: 546-745 & 543-214  
Telex: 60430 GTSENG

**G.T.S. Engineering Ltd.**  
153-161 Featherston Street  
Wellington  
P.O. Box 27-357  
New Zealand  
Telephone: 726-701

## REPUBLIC OF SOUTH AFRICA

**Protea PNI (Pty.) Ltd.**  
746 6th Street  
Wynberg, Sandton  
P.O. Box 39127  
Bramley 2018  
Transvaal  
Republic of South Africa  
Telephone: 786-3647  
Telex: 4-24409 SA  
Cable: "MANLU"-Transvaal

## ZIMBABWE

**Protea Medical Services  
(Pvt) Ltd.**  
111, Kelvin Rd. South  
Graniteside, Salisbury  
P.O. Box 2766  
Telephone: 704094  
Telex: 4-102 RH  
Cable: "MANLU"

For countries not listed contact:  
**Keithley Instruments, Inc.**  
U.S. Headquarters  
28775 Aurora Rd.  
Cleveland, Ohio 44139  
Telephone: (216) 248-0400  
Telex: 98-5469

# U.S./Distributors

The following instruments are available from stock at distributor locations throughout the U.S.

**Handheld DMMs** (pages 17 to 20)  
Models 128, 130, 131,  
132C, 132F, 135A

**Bench DMMs** (pages 22 to 26)  
Model 169, 179A, 191

**Thermometers** (pages 36 to 45)  
Models 865, 866, 868, 869,  
871, 872

## ARKANSAS

**Ft. Smith**  
Carlton-Bates Co (501) 646-8201  
**Little Rock**  
Carlton-Bates Co. (501) 562-9100  
**Pine Bluff**  
Carlton-Bates Co. (501) 535-1354  
**Springdale**  
Carlton-Bates Co. (501) 756-5012  
**ARIZONA**

**Phoenix**  
Electronic Parts Co. (602) 277-7281  
Metermaster (602) 243-4111

**Tucson**  
Anatech Corp. (602) 881-2348  
**CALIFORNIA**

**Arcadia**  
Shafer Eng. Services (213) 795-5000  
**Chatsworth**  
Priority One (213) 709-5464

**Dublin**  
Standard Meter Labs (415) 828-4837

**Hayward**  
Measurite (415) 471-4655

**Los Angeles**  
EIL Instruments (213) 685-7020  
Metermaster (213) 685-4340

**North Hollywood**  
B. J. Wofle Enterprises (213) 877-5518

**Oakland**  
Brill Electronics (415) 834-5888

**Palo Alto**  
Metermaster (415) 968-0313

**Sacramento**  
Zackit/Sacramento (916) 446-3131

**Santa Ana**  
Acorn Industrial Elect. (714) 547-8424

**San Diego**  
Metermaster (714) 560-4841

**San Francisco**  
EIL Instruments (408) 727-0396

**Santa Clara**  
Dynametron (408) 727-6531

**Sunnyvale**  
Ancrona (408) 243-4121  
**COLORADO**

**Colorado Springs**  
Walker Electronics (303) 636-1661

**Denver**  
EIL Instruments (303) 534-4160  
Walker Electronics (303) 935-2401

**Grand Junction**  
Walker Electronics (303) 242-4435

**Greeley**  
Walker Electronics (303) 353-3241

**Pueblo**  
Walker Electronics (303) 542-1924  
**CONNECTICUT**

**Middletown**  
EIL Instruments (203) 346-6646  
**FLORIDA**

**Cocoa**  
Capes Electric Supply (305) 636-6331

**Dania**  
Summit Electronics (305) 920-6253

**Ft. Lauderdale**  
Southeastern Electronics (305) 563-4131

**Jacksonville**  
EMSCO (Hammond) (904) 356-4851

**Miami**  
Electronic Equipment (305) 871-3500  
Tesco-Tymms (305) 681-8544

**Orlando**  
EMSCO (Hammond) (305) 849-6060  
Sun Electric Supply (305) 841-4650

**Palm Bay**  
EIL Instruments (305) 725-8300  
**Tampa**  
EMSCO (Hammond) (813) 253-0104  
**W. Palm Beach**  
Dolphin Electric Supply (305) 272-6086  
**GEORGIA**

**Atlanta**  
Ancrona (404) 261-7100  
EIL Instruments (404) 688-5549  
Metermaster (404) 446-0166

## ILLINOIS

**Champaign**  
Klaus Radio (217) 356-1896  
**Chicago**  
Commodore-I (312) 394-5441  
EIL Instruments (312) 430-2292  
Metermaster (312) 593-8650  
Pacific Indicator (312) 261-1330  
Pioneer (312) 437-9860

**LaSalle**  
Klaus Radio (815) 223-7400  
**Niles**  
Joseph Electronics (312) 297-4200

**Peoria**  
Klaus Radio (309) 691-4840  
**Quincy**  
Klaus Radio (217) 223-7560  
**INDIANA**

**Fort Wayne**  
Commodore-I (219) 485-7315  
Graham (219) 423-3422

**Indianapolis**  
EIL Instruments (317) 545-1373  
Graham (317) 634-8202  
Pioneer (317) 849-7300  
**IOWA**

**Eldridge**  
Klaus Radio (319) 285-8484  
**KANSAS**

**Industrial Airport**  
North Supply (913) 791-7000  
**Salina**  
RSC Electronics (913) 823-6353

**Wichita**  
Radio, Inc. (316) 264-2798  
RSC Electronics (316) 267-5213  
**KENTUCKY**

**Florence**  
URI Electronics (606) 371-4423  
**Louisville**  
EIL Instruments (502) 454-3432  
**LOUISIANA**

**Alexandria**  
Ralph's Electronics (318) 443-4517  
**Baton Rouge**  
Ralph's Electronics (504) 344-3761

**Lafayette**  
Ralph's Electronics (318) 234-4507  
**Lake Charles**  
Ralph's Electronics (318) 439-2493

**Morgan City**  
Ralph's Electronics (504) 384-9831  
**New Iberia**  
Ralph's Electronics (318) 369-9816

**New Orleans**  
Wm. B. Allen Co. (504) 525-8222  
**MARYLAND**

**Baltimore**  
Sunshine (301) 661-5900  
**Gaithersburg**  
Pioneer (301) 948-0710

**Sparks**  
EIL Instruments (301) 771-4800  
**MASSACHUSETTS**

**Boston**  
EIL Instruments (617) 272-9450  
Calibron Inst. (617) 894-6440  
**Burlington**  
Contact East (617) 272-5051  
**MICHIGAN**

**Detroit**  
NIDI (800) 543-4780  
Pioneer (313) 525-1800

**Lansing**  
Main Electronics (517) 882-5035  
**Negaunee**  
NWR Electronics (906) 228-9080

## MINNESOTA

**Bloomington**  
NWR Electronics (612) 854-7329  
**MISSOURI**

**Kansas City**  
Electronics Supply (816) 931-0250  
**St. Louis**  
Olive Electronics (314) 426-4500  
Scherrer Instruments (314) 644-5362  
**NEW JERSEY**

**Fairfield**  
Ampower (201) 227-7720  
**North Caldwell**  
Hosica Laboratories (201) 256-7724

**East Hanover**  
Delburn Electronics (201) 884-0800  
**NEW MEXICO**

**Albuquerque**  
Electronic Parts Co. (505) 293-6161  
**Farmington**  
Walker Electronics (505) 327-6556  
**NEW YORK**

**Buffalo**  
Summit Electronics (716) 887-2800  
Trott Electronics (716) 634-8500

**Great Neck (Long Island)**  
Instrument Mart (516) 487-7430  
**Hauppauge (Long Island)**  
EIL Instruments (516) 231-6333

**New York**  
Advance Electronics (800) 223-0474  
**Rochester**  
Ampower (716) 377-1020

EIL Instruments (716) 424-5750  
E.I.C. Electronics (716) 544-4392  
Summit Distributors (716) 334-8111  
Trott Electronics (716) 586-8251  
**NORTH CAROLINA**

**Asheville**  
Dixie Electronics (704) 252-8000  
**Charlotte**  
Dixie Electronics (704) 377-5413  
Trott Electronics (704) 376-2237

**Raleigh**  
Metermetrics (919) 872-5456  
**Winston-Salem**  
Dixie Electronics (919) 724-5961  
**OHIO**

**Cincinnati**  
Graham (513) 772-1661  
Stotts-Friedman (513) 251-3633  
URI Electronics (513) 761-4030

**Cleveland**  
Christy Labs (216) 651-4100  
Pioneer (216) 587-3600  
NIDI (800) 762-4755  
Repco (216) 248-8900

**Dayton**  
EIL Instruments (216) 435-2134  
Pioneer (513) 236-9900  
NIDI (513) 435-4503  
Stotts-Friedman (513) 298-5555

**Mansfield**  
Hoover (419) 529-3226  
Servex (419) 529-2181

**Marion**  
Servex (614) 383-3117  
**Sandusky**  
Servex (419) 626-5265

**Wooster**  
Servex (216) 264-9006  
**OKLAHOMA**

**Oklahoma City**  
Radio, Inc. (405) 789-0741  
**Tulsa**  
Economy Gauge (918) 622-8570  
Radio, Inc. (918) 587-9123

**PORTLAND**  
Radar Electric Co. (503) 233-3691  
Westcon (503) 283-0132  
**PENNSYLVANIA**

**Allentown**  
Barbey Electronics (215) 821-5551  
**Drexel Hill**  
Kass Electronic Dist. (215) 449-2300

**Lancaster**  
Barbey Electronics (717) 393-5637  
**Mckeesport**  
Barno (412) 751-5966

**Philadelphia**  
EIL Instruments (215) 561-4090  
Pioneer (215) 674-4000  
Sunshine (215) 673-5600

**Pittsburgh**  
EIL Instruments (412) 731-5230  
Pioneer (412) 782-2300  
NIDI (800) 543-4780

**Reading**  
Barbey Electronics (215) 376-7451  
**SOUTH CAROLINA**

**Charleston**  
Dixie Electronics (803) 554-7515  
**Columbia**  
Dixie Electronics (803) 779-5332  
Metermetrics (800) 446-7230

**Florence**  
Dixie Electronics (803) 669-8201  
**Greenville**  
Dixie Electronics (803) 232-6367

**Spartanburg**  
Dixie Electronics (803) 683-3681  
**TENNESSEE**

**Gray**  
Dixie Electronics (615) 477-3838  
**Knoxville**  
Dixie Electronics (615) 938-4131

**Nashville**  
Carlton-Bates Co. (615) 244-3562  
**TEXAS**

**Austin**  
Roy E. Davis (512) 835-1052  
**Beaumont**  
Ralph's Electronics (713) 833-9443

**Dallas**  
Economy Gauge (214) 243-8370  
EIL Instruments (214) 931-1236  
Metermaster (214) 271-5671  
Pioneer (214) 386-7300

Roy E. Davis Co. (214) 688-0652  
Specialized Products (214) 358-4663  
**Fort Worth**  
Economy Gauge (817) 831-2126  
Allied Electronics (817) 336-5401

**Houston**  
Ancrona (713) 529-3489  
Economy Gauge (713) 688-4494  
EIL Instruments (713) 271-3100  
Pioneer (713) 988-5555

Quality Inst. Labs (713) 524-0528  
Ralph's Electronics (713) 748-4902  
Specialized Products (713) 789-6610

**McAllen**  
Roy E. Davis (512) 631-1168  
**Texarkana**  
McCulloch Electronics (214) 792-6923  
**UTAH**

**Salt Lake City**  
Standard Supply (801) 486-3371  
**VIRGINIA**

**Alexandria**  
EIL Instruments (703) 354-4330  
**Richmond**  
EIL Instruments (804) 355-6604  
Instrument Tech. Reps  
(804) 275-1431

**Virginia Beach**  
EIL Instruments (804) 449-3746  
**WASHINGTON**

**Seattle**  
EIL Instruments (206) 762-0880  
Radar Electric Co. (206) 282-2511

**Spokane**  
Radar Electric Co. (509) 747-3053  
**WISCONSIN**

**Milwaukee**  
Compco (414) 438-0610  
E-M Instruments (414) 272-7799

**Mequon**  
Taylor Electric Co. (414) 241-4321  
**WYOMING**

**Casper**  
Walker Electronics (307) 237-1943

# KEITHLEY

Mr A Missira  
Racal Milgo  
Chesford Grange  
Woolston  
WARRINGTON  
WA1 4RH

17.11.83

Dear Sir,

Re: Telephone request for 610C information

Thank you for your interest in our instruments. The information you requested is enclosed with this letter, together with a business reply card.

Further information on our products can be obtained by using the enclosed card or by contacting this office by phone or telex.

In many cases demonstration facilities are available and we would be only too pleased to make the necessary arrangements at your request.

Yours faithfully,  
KEITHLEY INSTRUMENTS LTD.

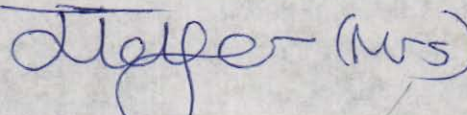
*pc*  
 (Mrs)

N.J. Challacombe  
Director

# Sales Representatives/U.S.A.

## U.S. HEADQUARTERS

28775 Aurora Road  
Cleveland, Ohio 44139  
(216) 248-0400  
Twx: 98-5469

1. **MECO, INC.**  
1321 Main Street  
Reading, MA 01867  
(617) 944-6660  
P.O. Box 67  
Enfield, CT 06082  
(617) 944-6660  
(800) 225-3409 (CT, VT, NH & RI)
2. **SDM REPRESENTATIVES, INC.**  
150 Essex St.  
Lodi, NJ 07644  
(201) 368-0123  
85 Avenue E.  
Rochester, NY 14621  
(716) 467-0076
3. **SCIENTIFIC ASSOCIATES, INC.**  
9512A Lee Highway  
Fairfax, VA 22031  
(703) 385-0600  
Cockeysville, MD  
(301) 321-1411  
Scientific Representatives  
304 Cooper Ctr.  
Pennsauken, NJ 08109  
(609) 662-5222
4. **W.A. BROWN INSTRUMENTS, INC.**  
P.O. Box 513  
Orlando, FL 32802  
(305) 425-5505  
3781 N.E. Expressway  
Suite #124  
Atlanta, GA 30340  
(404) 455-1035  
2800 Bush River Road  
Suite #3B  
Columbia, SC 29210  
(803) 798-8070

828 Glendale Avenue  
Durham, NC 27701  
(919) 683-1580  
1500 N.W. 62nd St.  
Suite #504  
Ft. Lauderdale, FL 33309  
(305) 776-4800  
207B Green Cove Rd. S.E.  
Huntsville, AL 35803  
(205) 883-8660  
132 Fairbanks Road  
Oak Ridge, TN 37830  
(615) 482-5761  
P.O. Box 1406  
701 Lincoln Ave.  
Melbourne, FL 32901  
(305) 723-0835  
P.O. Box 786  
Mandeville, LA 70448  
(504) 626-9701

5. **SECTOR ENGINEERING SALES, INC.**  
770 N. Church Road  
Elmhurst, IL 60126  
(312) 530-7850  
8705 Port Washington Road  
Milwaukee, WI 53217  
(414) 352-8280  
9613 Girard Ave. S.  
Bloomington, MN 55431  
(612) 888-6920  
8463 Castlewood Drive  
Indianapolis, IN 46250  
(317) 842-1120

6. **EQS SYSTEMS**  
P.O. Box 445  
Chesterland, OH 44026  
(216) 729-2222  
Detroit, MI  
(313) 961-3042  
Dayton, OH  
(513) 294-2476  
Pittsburgh, PA  
(412) 261-2604  
Cincinnati, OH  
(513) 294-2476  
Columbus, OH  
(614) 228-3453

7. **TESTECH**  
1000 E. Campbell Rd.  
Suite #108  
Richardson, TX 75081  
(214) 644-5010  
9219 Katy Freeway  
Suite #124  
Houston, TX 77024  
(713) 467-2192  
2525 Wallingwood Dr.  
Suite #804  
Austin, TX 78746  
(512) 327-7033

8. **PALATINE SALES, INC.**  
Headquarters  
432 Chez Patee Dr.  
Hazelwood, MO 63042  
(314) 839-0800  
(Temporary)  
P.O. Box 336  
Rosehill, KS 67133  
(316) 776-0065

5829 Outlook, Ste. #6  
Mission, KS 66202  
(913) 831-0555  
708 J Avenue NE  
Suite #11B  
Cedar Rapids, IA 52402  
(319) 365-8071

9. **AZTEC ENTERPRISES**  
5000 Copper N.E.  
Albuquerque, NM 87108  
(505) 262-1688  
61 W. Davies  
Littleton, CO 80120  
(303) 795-0250  
1944 W. North Lane #1  
Phoenix, AZ 85021  
(602) 944-9185  
2161 Regent Street, #7  
Salt Lake City, UT 84115  
(801) 487-4759

10. **McLAREN, INC.**  
P.O. Box 2029  
Bellevue, WA 98009  
(206) 454-3400  
5319 SW Westgate Drive  
Portland, OR 97221  
(503) 297-2248

11. **T. LOUIS SNITZER COMPANY**  
9005 Exposition Blvd.  
Los Angeles, CA 90034  
(213) 836-6170  
10320 S. De Anza Blvd.  
Cupertino, CA 95014  
(408) 257-8333  
P.O. Box 805  
Del Mar, CA 92014  
(714) 226-0305

1. **MECO, INC.**
2. **SDM REPRESENTATIVES, INC.**
3. **SCIENTIFIC ASSOCIATES, INC.**
4. **W.A. BROWN INSTRUMENTS, INC.**
5. **SECTOR ENGINEERING SALES, INC.**
6. **EQS SYSTEMS**
7. **TESTECH**
8. **PALATINE SALES, INC.**
9. **AZTEC ENTERPRISES**
10. **McLAREN, INC.**
11. **T. LOUIS SNITZER COMPANY**

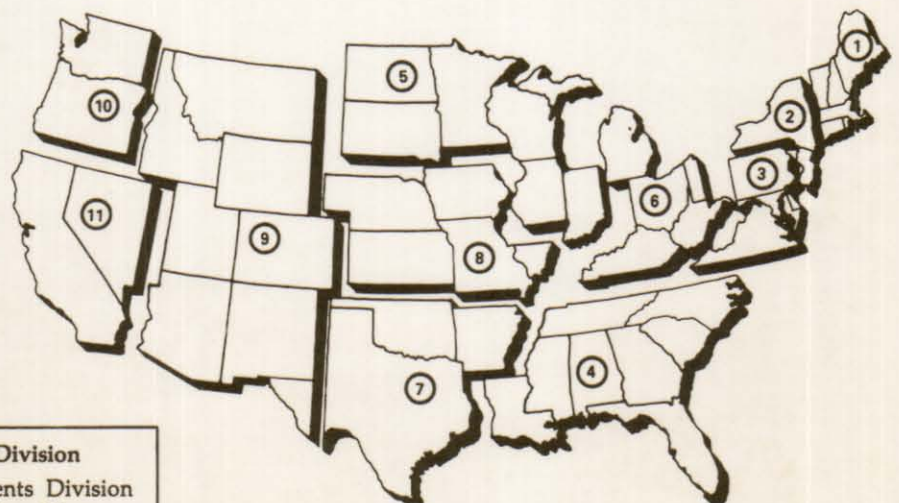

### Systems Division/Radiation Measurement Division

Sales offices listed represent Keithley Instruments Division only. To learn the name of the Systems or Radiation Measurement Division representative in your area, please contact:

**Keithley Instruments, Inc.**  
28775 Aurora Road/Cleveland, Ohio 44139  
Telephone: (216) 248-0400/Telex: 98-5469

or use the reply cards located at the end of this catalog.





**BUSINESS REPLY CARD**

FIRST CLASS PERMIT NO. 11759 CLEVELAND, OHIO  
POSTAGE WILL BE PAID BY ADDRESSEE

KEITHLEY INSTRUMENTS, INC.  
28775 Aurora Road  
Cleveland, Ohio 44139-9990



NO POSTAGE  
NECESSARY  
IF MAILED  
IN THE  
UNITED STATES

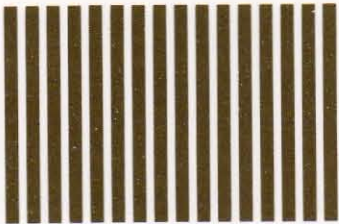

NO POSTAGE  
NECESSARY  
IF MAILED  
IN THE  
UNITED STATES

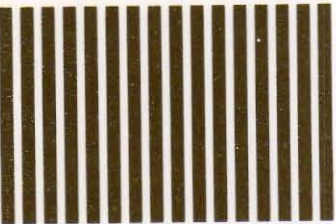

**BUSINESS REPLY CARD**

FIRST CLASS PERMIT NO. 11759 CLEVELAND, OHIO  
POSTAGE WILL BE PAID BY ADDRESSEE

KEITHLEY INSTRUMENTS, INC.  
28775 Aurora Road  
Cleveland, Ohio 44139-9990



**BUSINESS REPLY CARD**

FIRST CLASS PERMIT NO. 11759 CLEVELAND, OHIO  
POSTAGE WILL BE PAID BY ADDRESSEE

KEITHLEY INSTRUMENTS, INC.  
28775 Aurora Road  
Cleveland, Ohio 44139-9990



NO POSTAGE  
NECESSARY  
IF MAILED  
IN THE  
UNITED STATES

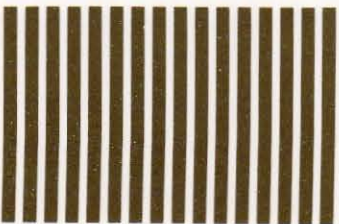

NO POSTAGE  
NECESSARY  
IF MAILED  
IN THE  
UNITED STATES

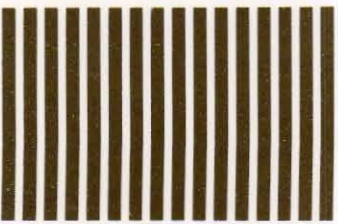

**BUSINESS REPLY CARD**

FIRST CLASS PERMIT NO. 11759 CLEVELAND, OHIO  
POSTAGE WILL BE PAID BY ADDRESSEE

KEITHLEY INSTRUMENTS, INC.  
28775 Aurora Road  
Cleveland, Ohio 44139-9990

SEND THE LATEST PRODUCT INFORMATION:

KEITHLEY

INSTRUMENT DIVISION  Handheld DMMs  Portable/Bench DMMs  System Components  Scientific Instruments  Digital Thermometers

SYSTEMS DIVISION  System 250  System 300

RADIATION MEASUREMENTS DIVISION  Dosimeters  Survey Meters  Log Picoammeters  Ion Chambers

Evaluation/Demo Unit, Model(s) \_\_\_\_\_  
 Current Price List  Have someone contact me.  
 Other: \_\_\_\_\_

NAME \_\_\_\_\_ PHONE \_\_\_\_\_ ( ) \_\_\_\_\_

COMPANY \_\_\_\_\_ TITLE \_\_\_\_\_

ADDRESS \_\_\_\_\_ M/S, DEPT OR DIV. \_\_\_\_\_

CITY \_\_\_\_\_ STATE \_\_\_\_\_ ZIP \_\_\_\_\_

COUNTRY \_\_\_\_\_ CAT 83/84

SEND THE LATEST PRODUCT INFORMATION:

KEITHLEY

INSTRUMENT DIVISION  Handheld DMMs  Portable/Bench DMMs  System Components  Scientific Instruments  Digital Thermometers

SYSTEMS DIVISION  System 250  System 300

RADIATION MEASUREMENTS DIVISION  Dosimeters  Survey Meters  X-ray Timers  Ion Chambers

Evaluation/Demo Unit, Model(s) \_\_\_\_\_  
 Current Price List  Have someone contact me.  
 Other: \_\_\_\_\_

NAME \_\_\_\_\_ PHONE \_\_\_\_\_ ( ) \_\_\_\_\_

COMPANY \_\_\_\_\_ TITLE \_\_\_\_\_

ADDRESS \_\_\_\_\_ M/S, DEPT OR DIV. \_\_\_\_\_

CITY \_\_\_\_\_ STATE \_\_\_\_\_ ZIP \_\_\_\_\_

COUNTRY \_\_\_\_\_ CAT 83/84

SEND THE LATEST PRODUCT INFORMATION:

KEITHLEY

INSTRUMENT DIVISION  Handheld DMMs  Portable/Bench DMMs  System Components  Scientific Instruments  Digital Thermometers

SYSTEMS DIVISION  System 250  System 300

RADIATION MEASUREMENTS DIVISION  Dosimeters  Survey Meters  Log Picoammeters  Ion Chambers

Evaluation/Demo Unit, Model(s) \_\_\_\_\_  
 Current Price List  Have someone contact me.  
 Other: \_\_\_\_\_

NAME \_\_\_\_\_ PHONE \_\_\_\_\_ ( ) \_\_\_\_\_

COMPANY \_\_\_\_\_ TITLE \_\_\_\_\_

ADDRESS \_\_\_\_\_ M/S, DEPT OR DIV. \_\_\_\_\_

CITY \_\_\_\_\_ STATE \_\_\_\_\_ ZIP \_\_\_\_\_

COUNTRY \_\_\_\_\_ CAT 83/84

SEND THE LATEST PRODUCT INFORMATION:

KEITHLEY

INSTRUMENT DIVISION  Handheld DMMs  Portable/Bench DMMs  System Components  Scientific Instruments  Digital Thermometers

SYSTEMS DIVISION  System 250  System 300

RADIATION MEASUREMENTS DIVISION  Dosimeters  Survey Meters  X-ray Timers  Ion Chambers

Evaluation/Demo Unit, Model(s) \_\_\_\_\_  
 Current Price List  Have someone contact me.  
 Other: \_\_\_\_\_

NAME \_\_\_\_\_ PHONE \_\_\_\_\_ ( ) \_\_\_\_\_

COMPANY \_\_\_\_\_ TITLE \_\_\_\_\_

ADDRESS \_\_\_\_\_ M/S, DEPT OR DIV. \_\_\_\_\_

CITY \_\_\_\_\_ STATE \_\_\_\_\_ ZIP \_\_\_\_\_

COUNTRY \_\_\_\_\_ CAT 83/84

**KEITHLEY INSTRUMENTS, INC.**

28775 Aurora Road/Cleveland, Ohio 44139/U.S.A./ (216) 248-0400/Telex: 98-5469

**KEITHLEY INSTRUMENTS, GmbH**

Heiglhofstrasse 5/D-8000 München 70/WEST GERMANY/(089) 714-40-65/Telex: 521 21 60

**KEITHLEY INSTRUMENTS, LTD.**

1, Boulton Road/Reading, Berkshire RG2 ONL/GREAT BRITAIN/(0734) 86 12 87/Telex: 847047

**KEITHLEY INSTRUMENTS, SARL**

2 Bis, Rue Léon Blum/B.P. 60/91121 Palaiseau Cedex/France/(6) 011.51.55/Telex: 600933F

**KEITHLEY INSTRUMENTS, BV**

Leidsestraatweg 149/Postbus 1190 /NL-Woerden/NETHERLANDS/(03480) 13 643/Telex: 40 311

**KEITHLEY INSTRUMENTS, SA**

Kriesbachstr. 4/CH-8600 Dübendorf/SWITZERLAND/01 821 94 44/Telex: 57 536

**KEITHLEY INSTRUMENTS, Ges.m.b.H.**

Döblinger Hauptstr. 32/A-1190 Wien/AUSTRIA/0222 314 289/Telex: 13 45 00

**KEITHLEY**