

Operating Instructions

Original?

ARCHIVE COPY

**DO NOT REMOVE FROM FILES
WITHOUT PERMISSION**

**RETURN TO MANUALS PRODUCTION
GRAPHICS BLDG (76)**

PROBE ADAPTER

For

JENNINGS RADIO MFG CO
JP-325 Probe and Accessories



453

Copyright © 1964 by Tektronix, Inc.,
Beaverton, Oregon. Printed in the United
States of America. All rights reserved.
Contents of this publication may not be re-
produced in any form without permission
of the copyright owner.

070-453

764

Tektronix, Inc.

P. O. Box 500 • Beaverton, Oregon • Phone: MI 4-0161 • Cable: Tektronix

Tektronix International A.G.

P. O. Box 57 • Zug, Switzerland • Cable: Tekintag, Zug Switzerland • Telex: 53.574

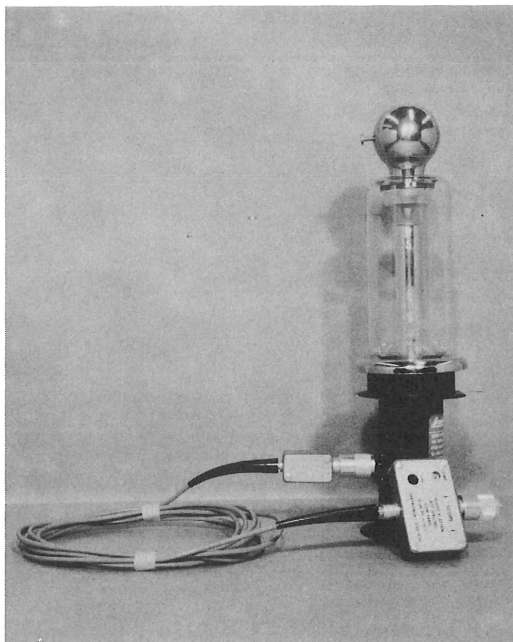

10,000:1 VACUUM CAPACITOR PROBE
 Jennings Type JP-325 Probe
 with Tektronix 030-030 Adapter

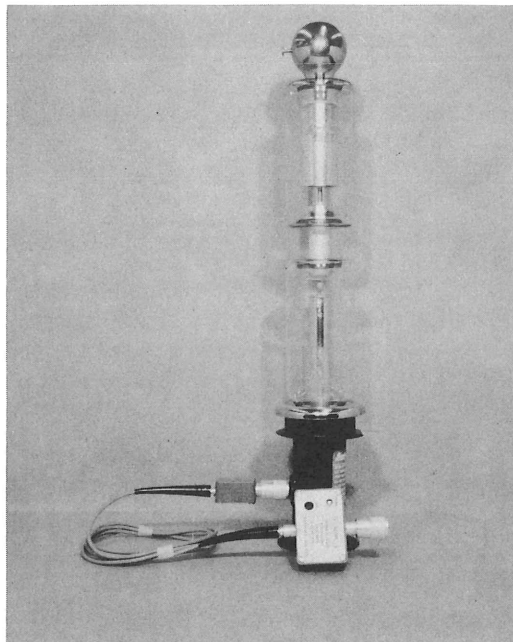

20,000:1 VACUUM CAPACITOR PROBE
 Jennings Type JP-325 Probe
 and Jennings JCD5 Vacuum Capacitor
 with Tektronix 030-029 Adapter

ADAPTERS AVAILABLE

- TEK 030-029 Probe Adapter with 6 ft. cable
(No Probe)
- TEK 030-030 Probe Adapter with 12 ft. cable
(No Probe)
- TEK 030-032 Probe Adapter with 6 ft. cable,
Jennings 60 KV Type JP-325 Probe
- TEK 030-033 Probe Adapter with 12 ft. cable,
Jennings 60 KV Type JP-325 Probe

CALIBRATION PROCEDURE

Calibration of the Jennings JP-325 Vacuum Capacitor Voltage Divider (Probe) and the Tektronix probe adapter is a two-step process.

The first step is the adjustment of the overall attenuation of the probe/probe-adapter combination to exactly 10,000:1; the second is compensation of the probe adapter for optimum transient response.

Step one is accomplished by applying the full Square-wave Calibrator voltage (100 volts, peak-to-peak) to the probe adapter and setting the CAL adjustment on the probe adapter to give exactly 10,000:1 overall voltage attenuation. Use of a Type B Plug-in Unit is recommended for this step since, at maximum gain, it will dis-

play 2 cm peak-to-peak on the CRT for 100 volts, peak-to-peak, input to the probe.

Step two is accomplished by adjusting the COMP control on the probe adapter for optimum transient response. This compensation will depend on the input capacitance of the plug-in unit being used. Therefore, this adjustment should be made in conjunction with the plug-in unit that will be used when making measurements.

The bandwidth of the probe with either adapter is **approximately** 10 Mc. It will be 3 db down at 10 cps on the low end. The upper-end bandwidth will be determined by the oscilloscope system used with it.

Note: To calibrate the old-style Tek 030-017 Probe Adapter, reverse steps one and two of the foregoing procedure.

Jennings
RADIO
ELECTRONIC CORPORATION

SPECIFICATIONS

TYPE JP-325

HIGH VOLTAGE

AC PROBE

APPLICATIONS

The JP-325 is a capacitive voltage divider probe with division ratio of 325:1. This probe can be used with an oscilloscope to measure and observe voltages up to 50 kv and frequencies up to 50 megacycles. It is particularly suited for rf applications due to its low circuit loading and shielded construction. Typical circuit applications include:

1. Radio frequency tank and transmission line voltages
2. Audio output and modulation voltages
3. All types of pulse measurements
4. X-ray exposure voltages
5. Transient waves such as those occurring when reactive circuits are being switched.

DESCRIPTION

The Jennings Vacuum Capacitor Voltage Dividers used in the JP-325 are constructed of coaxial copper cylinders so that the two dividing capacities are enclosed in a single vacuum unit. This makes possible a low inductance divider that minimizes problems of resonance at high frequencies and the distortion of steep wave fronts.

The low voltage probe is a cylinder which is surrounded by another cylinder attached to the grounded mounting flange. Thus the two dividing capacities are fully shielded internally.

The low voltage terminal is housed in a shield can containing a padding capacitor to give the proper division ratio. It is brought out through a coaxial fitting with 3 ft. of cable for connection to the oscilloscope.

SPECIFICATIONS

VOLTAGE—

40, 50, or 60 kv pk

DIVISION RATIO—

Approximately 325:1 to termination of 3 ft. of RG-58A/U cable. (Dividing capacities are 2.8 mmfd at the high voltage end and 890 mmfd at the low voltage end).

CURRENT—

12.5 amperes rms maximum through the voltage divider

INPUT IMPEDANCE—

Resistance: above 10^{12} ohms

Capacitance: 4 mmfd

FREQUENCY RESPONSE—

The response at high frequencies is limited by that of the measuring instrument. (Internal resonances are above 200 megacycles). The low frequency response is 1000 cps if operating into 1 megohm shunt resistance, 100 cps if operating into 10 megohm shunt resistance, and the lowest frequency to which the scope will respond if operating directly into the vertical deflection plates of an oscilloscope (i.e., over 100 megohms shunt resistance.)

DIMENSIONS—Length 12 5/8", Diameter 3 11/32"

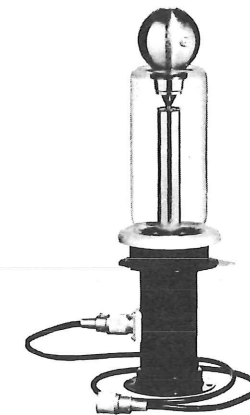

SPECIFICATIONS

TYPE JCD-5

VACUUM CAPACITOR

APPLICATION

The Type JCD-5 vacuum capacitor is designed to double the voltage rating of the JP-325 High Voltage Probe and the J-1002 High Voltage Vacuum Tube Voltmeter. It attaches to the high voltage end of the VDF 2.8 capacitive voltage divider used in each instrument. The actual multiplying factor may be found by applying a convenient voltage below 50 kv to the meter or probe, noting the reading on the meter or oscilloscope. This reading divided by a reading taken with the JCD capacitor installed will give the multiplying factor to be applied to voltmeter or oscilloscope readings. This calibration may take place at any frequency within the frequency range of the meter or the probe and scope with which it is used.

DESCRIPTION

The JCD-5 is similar in construction to the VDF 2.8 voltage divider in that it is made of coaxial cylinders so that the outside cylinder acts as a shield for the input terminal to the VDF 2.8. This shielding of the connection between the series capacitor and the voltage divider to which it is attached is effective in eliminating stray pickup as long as other circuitry is kept 12 inches away from the connecting link.

SPECIFICATIONS

VOLTAGE—60 kv peak

CAPACITANCE—5 mmfd which decreases the total loading capacitance of the meter or probe from 4 mmfd to 2 mmfd.

DIMENSIONS—Length 5 7/8", Diameter 2 5/8"



NOTE: The JCD-5 is normally sold with the connector for attaching to the VDF 2.8 but without the corona sphere.

VACUUM CAPACITOR VOLTAGE DIVIDER



SPECIFICATIONS

VOLTAGE RATINGS—40, 50, & 60 PEAK KILOVOLTS

APPLICATIONS

Jennings voltage dividers may be used with a meter or oscilloscope to measure or view voltages as high as 60 kv peak. Applied voltages may be continuous, pulsed, or transient. With proper circuitry they are linear over a frequency range of less than 50 cps to well over 30 mc. They are particularly useful at high frequencies because they are physically small and fully shielded and because the capacitance added to the circuit being measured is very small - as low as 1.5 mmfd.

APPLICATIONS INCLUDE:

- Measuring rf tank and transmission line voltages
- Viewing output wave shape and timing of high voltage pulse generators
- Viewing the wave front of transients such as occur when switching inductive or capacitive loads
- Measuring percentage of modulation and output of audio circuits

These dividers can also be used in a balanced-to-ground arrangement to measure push-pull output and transmission line voltages as high as 120 kv peak. Single ended voltages as high as 120 kv peak can be divided by using Jennings Type JCD vacuum capacitor in series with a Type VDF 2.8 voltage divider.

DESCRIPTION

Jennings Vacuum Capacitor Voltage Dividers are constructed of coaxial copper cylinders so that the two dividing capacities are enclosed in a single vacuum unit. This makes possible a low inductance divider that minimizes problems of resonance at high frequencies and the distortion of steep wave fronts. The low voltage probe is a cylinder which is surrounded by another cylinder attached to the grounded mounting flange. Thus the two dividing capacities are fully shielded internally. Only the low voltage terminal requires external shielding and is usually inserted in a grounded box containing whatever padding capacitors are necessary to establish the desired division ratio. (Two 60 kv VDF 2.8 voltage dividers are used in Jennings Model J-1002 High Voltage Vacuum Tube Voltmeter).

SPECIFICATIONS

The standard voltage divider (Type VDF 2.8) has dividing capacities of 2.8 mmfd and 22 mmfd with an input loading capacity of 4 mmfd. If a lower loading capacity and a higher division ratio are necessary, a unit is available (Type VDF 0.4) with dividing capacities of 0.4 mmfd and 22 mmfd with an input loading capacity of 1.5 mmfd. With either unit the 22 mmfd capacity is shunted with a large, low loss capacitor which sets the division ratio and permits calibration to any given recording instrument having a high input shunt resistance. Either pulsed or continuous voltages may be applied up to the 40, 50, or 60 kv rating of the particular divider. Jennings Type JCD vacuum capacitor may be attached to the high voltage terminal of a 60 kv VDF 2.8 voltage divider in order to increase its voltage rating to 120 kv peak.

If leads are kept short enough, the divider can be used at frequencies well above 30 megacycles. However, at frequencies above 20 mc the continuous applied voltage must be kept low enough to avoid exceeding a current of 12.5 rms amperes through the 2.8 mmfd section of the voltage divider.

To maintain linearity at low frequencies (e.g., for calibration at 60 cps), it is necessary to have either a large padding capacitor or use a meter or oscilloscope with a very high input shunt resistance in order to keep the recording instrument from loading down the circuit.

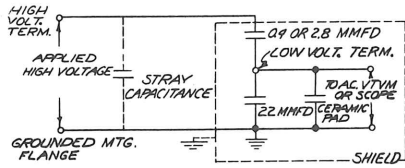

INTERNAL CIRCUIT OF VOLTAGE DIVIDER AND EXTERNAL PADDING CAPACITOR

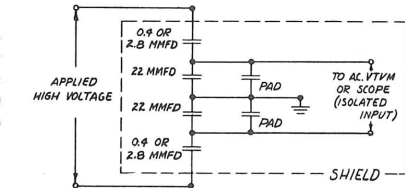

VOLTAGE DIVIDERS IN BALANCED-TO-GROUND ARRANGEMENT

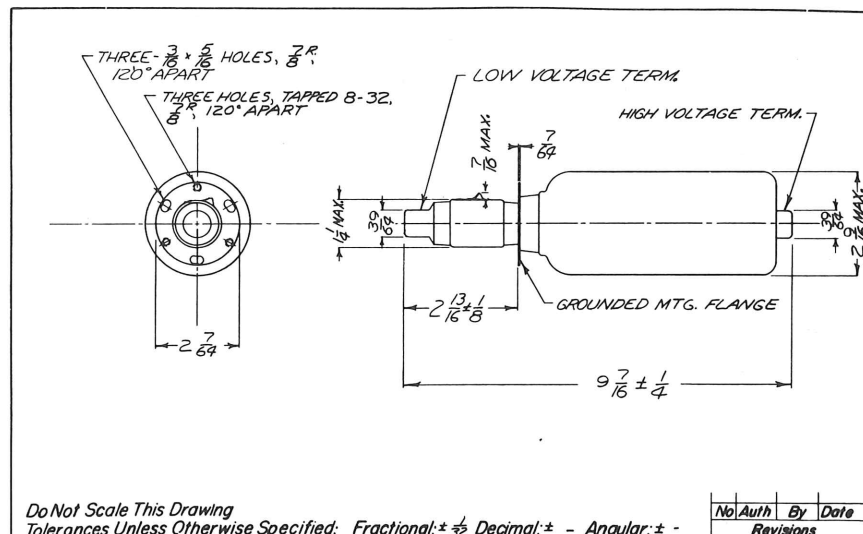
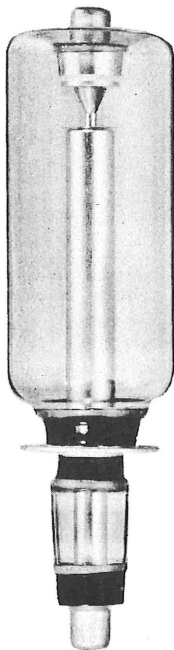

Do Not Scale This Drawing
Tolerances Unless Otherwise Specified: Fractional: $\pm \frac{1}{32}$ Decimal: \pm - Angular: \pm -

No	Auth	By	Date

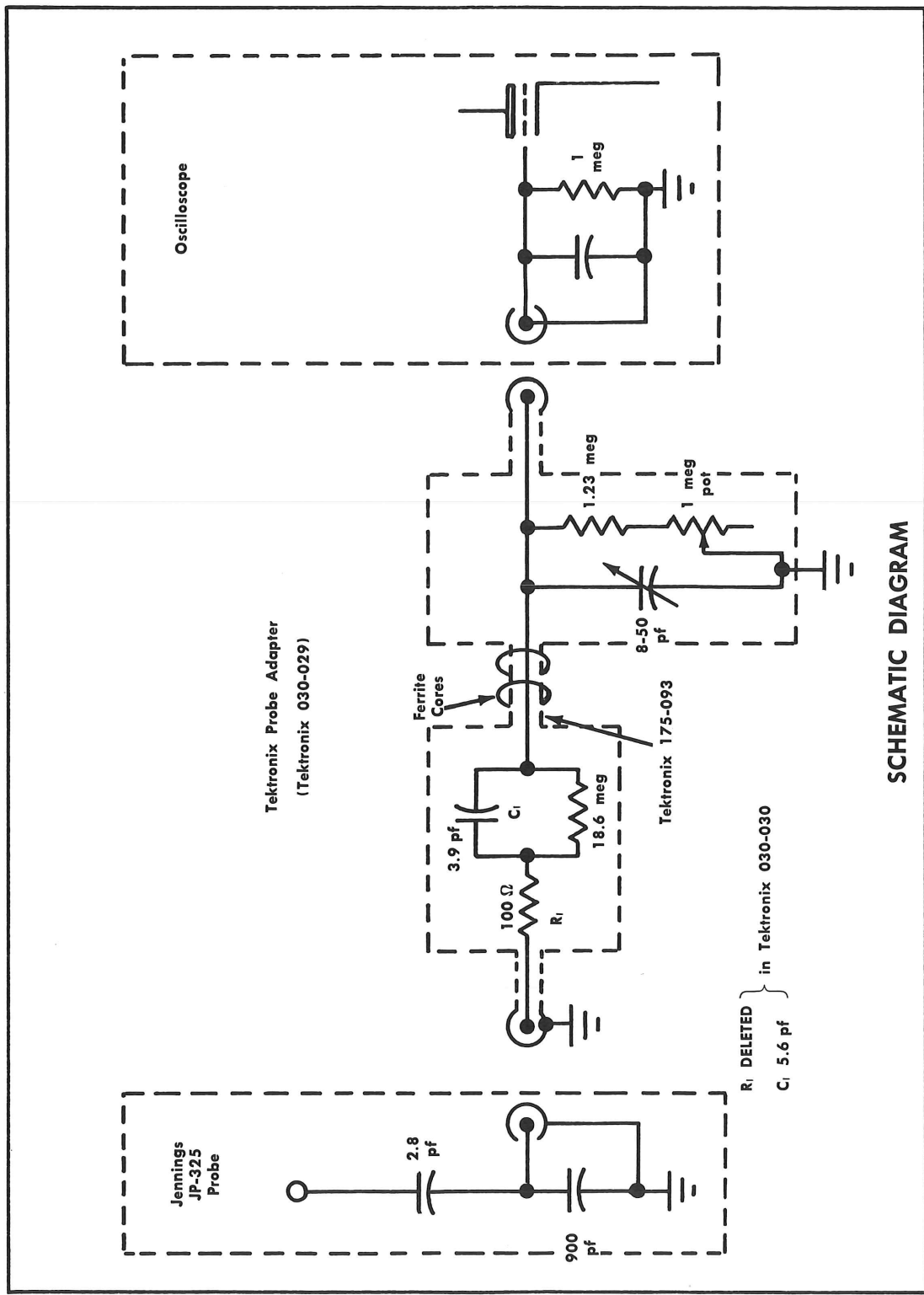

SCHMATIC DIAGRAM

