

INSTRUCTION MANUAL

Serial Number B060873

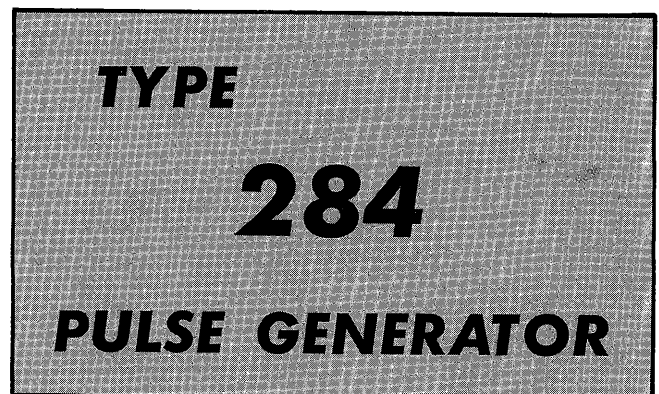

Tektronix, Inc.

S.W. Millikan Way • P. O. Box 500 • Beaverton, Oregon 97005 • Phone 644-0161 • Cables: Tektronix
070-0754-00

1067

K4XL's **BAMA**

This manual is provided **FREE OF CHARGE** from the “BoatAnchor Manual Archive” as a service to the Boatanchor community.

It was uploaded by someone who wanted to help you repair and maintain your equipment.

If you paid anyone other than BAMA for this manual, you paid someone who is making a profit from the free labor of others without asking their permission.

You may pass on copies of this manual to anyone who needs it. But do it without charge.

Thousands of files are available without charge from BAMA. Visit us at <http://bama.sbc.edu>



WARRANTY

All Tektronix instruments are warranted against defective materials and workmanship for one year. Tektronix transformers, manufactured in our own plant, are warranted for the life of the instrument.

Any questions with respect to the warranty mentioned above should be taken up with your Tektronix Field Engineer.

Tektronix repair and replacement-part service is geared directly to the field, therefore all requests for repairs and replacement parts should be directed to the Tektronix Field Office or representative in your area. This procedure will assure you the fastest possible service. Please include the instrument Type and Serial or Model Number with all requests for parts or service.

Specifications and price change privileges reserved.

Copyright © 1967 by Tektronix, Inc., Beaverton, Oregon. Printed in the United States of America. All rights reserved. Contents of this publication may not be reproduced in any form without permission of the copyright owner.

CONTENTS

Section 1	Specification
Section 2	Operating Instructions
Section 3	Circuit Description
Section 4	Maintenance
Section 5	Performance Check
Section 6	Calibration
	Abbreviations and Symbols
	Parts Ordering Information
Section 7	Electrical Parts List
	Mechanical Parts List Information
Section 8	Mechanical Parts List
Section 9	Diagrams
	Mechanical Parts List Illustrations
	Accessories

Abbreviations and symbols used in this manual are based on, or taken directly from, IEEE Standard 260 "Standard Symbols for Units", MIL-STD-12B and other standards of the electronics industry. Change information, if any, is located at the rear of this manual.



Fig. 1-1. Type 284 Pulse Generator.

SECTION 1

SPECIFICATION

Change information, if any, affecting this section will be found at the rear of the manual.

Introduction

The Tektronix Type 284 Pulse Generator provides specialized signals that are defined sufficiently to allow them to be used to verify the performance of fast general purpose and sampling oscilloscopes. Specifically, the signals allow a check of the vertical amplifier risetime, deflection factor accuracy, transient response and pulse flatness deviation (aberrations); plus checking upon the accuracy of horizontal sweep rates. The fast pulse may be used as a signal source for testing the risetime of transistors and amplifiers, or for Time Domain Reflectometry.

Each signal provides a trigger signal for externally triggering an oscilloscope time base generator. The fast pulser also generates a trigger in advance of the fast step, providing the pretrigger signal necessary for some sampling oscilloscopes.

Regulated DC power supplies assure stable operation over a wide range of line voltage and frequency. Circuits are

temperature compensated to maintain both amplitude and frequency accuracies over a wide temperature range.

The electrical characteristics that follow are divided into two categories. Information listed in the Performance Requirement column applies directly to the instrument performance and is a commitment by Tektronix, Inc., to the customer. Information listed in the Operational Information column is for clarification and operator convenience and is not to be used to specify any performance limits for the instrument. Characteristics listed in the Performance Requirement column are checked by the Performance Check procedure, Section 5, of this manual. Any instrument not meeting these performance limits can be brought within specifications by performing the Calibration Procedure, Section 6 of this manual. The performance requirements apply over an ambient temperature range of 0° C to +50° C, at altitudes up to 5,000 feet, with upper temperature limit decreased by 1° C per 1000 feet from 5000 feet to 15,000 feet, after a warm up period of five minutes, providing the convection cooling holes (bottom and both sides) are not obstructed. The unit may be stored in temperatures from -40° C to +65° C.

ELECTRICAL CHARACTERISTICS

Characteristic	Performance Requirement	Operational Information							
SINE WAVE OR SQUARE WAVE OUTPUT									
Calibrated PERIOD Signals									
Square Wave	10 μ s, 1 μ s and 100 ns	For checking sweep rates.							
Sine Wave	10 ns and 1 ns								
Signal Amplitude Into 50 Ω									
Square Wave	1 V, 100 mV and 10 mV	For checking deflection factors.							
Sine Wave	100 mV	For checking horizontal timing only.							
Accuracies	SIGNAL								
	Square Wave			Sine Wave			Square Wave		
	PERIOD	10 μ s	1 μ s	100 ns	10 ns	1 ns	10 μ s	1 μ s	100 ns
Timing		$\pm 0.5\%$	$\pm 0.5\%$	$\pm 0.05\%$	$\pm 1\%$	$\pm 1\%$	Amplitude accuracies in this column are based upon DC testing of attenuators.		
Amplitude	1 V	$\pm 0.5\%$	$\pm 0.5\%$	$\pm 2\%^1$					
	100 mV				$\pm 20\%$	$\pm 20\%$	$\pm 1\%$	$\pm 1\%$	$\pm 2.5\%^1$
	10 mV						$\pm 1.5\%$	$\pm 1.5\%$	$\pm 3\%^1$
Square Wave Duty Factor	48% to 52%								
Trigger Output Signal Amplitude, into 50 Ω									
Square Wave	+200 mV, $\pm 20\%$								
Sine Wave	200 mV peak to peak, $\pm 40\%$								

¹Measured 20 ns after pulse reaches 100% on Tektronix Type 353 or 453 Sampling Probe Unit. Measured 30 ns after pulse reaches 100% on Tektronix Type 451 Dual Trace Sampling Unit.

ELECTRICAL CHARACTERISTICS (cont)

PULSE GENERATOR

Characteristic	Performance Requirement	Operational Information
Repetition Rate	50 kHz, $\pm 10\%$	20 μ s period
Risetime, 10% to 90%	≤ 70 ps	
Amplitude into 50 Ω	$\geq +200$ mV	Step beginning adjusted to zero volts during calibration.
Pulse Flatness Deviation	During first 2 ns after pulse reaches 100% amplitude: $\leq 3\%$ p-p total deviation over a range from +3% to -3%. After 2 ns: $\leq 2\%$ p-p total deviation over a range from +2% to -2%.	Aberrations
Internal Pulser Assembly Signal Reflections due to changes of impedance	$\leq \pm 5\%$, measured by Tektronix Type 1S2 TDR unit.	
Pulse Duration, 50% to 50%	1 μ s, +50%, -0%	

TRIGGER OUTPUT SIGNAL WHEN USING PULSE GENERATOR

Amplitude	+200 mV, $\pm 20\%$	
Risetime, 10% to 90%	≤ 3 ns	
Pulse Duration, 50% to 50%	≥ 10 ns	
Trigger Pulse Occurrence In Advance of PULSE OUTPUT Signal	5 ns or 75 ns, ± 5 ns ¹	Selectable by LEAD TIME switch

POWER LINE REQUIREMENTS

Line Voltage Ranges		
115 Volt Line	90 VAC to 136 VAC	
230 Volt Line	180 VAC to 272 VAC	
Frequency Range	48 Hz to 440 Hz	
Maximum Power Consumption	Approximately 6.5 Watts at 115 VAC 60 Hz	
Fuse Data	Use Fuses listed in Parts List	

MECHANICAL CHARACTERISTICS

Dimensions

- Height 6³/₄ inches
- Width 4¹/₂ inches
- Length 15 inches

Approximate dimensions include knobs and connectors.

Construction—Aluminum alloy chassis with epoxy laminated circuit boards. Front panel is anodized aluminum.

Accessories—An illustrated list of the accessories supplied with the Type 284 is at the end of the Mechanical Parts List pullout pages.

¹Serial numbers B010100-B020235; 5 ns or 50 ns, ± 5 ns.

SECTION 2

OPERATING INSTRUCTIONS

Change information, if any, affecting this section will be found at the rear of the manual.

General

This section of the manual provides the basic information required for operation of the Type 284. Instructions include function of the front panel controls and connectors, first time operation, general operating information, and basic applications.

AC Power Considerations

The Type 284 can be operated from either a 115 or a 230-volt line, at frequencies from 48 to 440 Hz. The AC line voltage selector panel and fuse holder is located on the rear panel of the Type 284.

CAUTION

The Type 284 should not be operated with the voltage selector in an incorrect position for the nominal line voltage applied. Operation of the instrument in a wrong voltage range will either provide incorrect operation or damage the instrument.

The AC line voltage selector panel on the rear of the Type 284 indicates nominal line voltage selected. See Fig. 2-2. Check to see that the plastic indicating tab of the line selector is protruding through the selector panel, indicating that its position is proper for applied nominal line voltage (115 or 230 AC Volts).

The selector assembly cover can be removed to change the nominal line from 115 Volts to 230 Volts or vice versa, or to replace the fuses. Use the following procedure:

1. Disconnect the instrument from the power source.
2. Loosen the two captive screws which hold the cover onto the voltage selector assembly, then pull to remove the cover.
3. To convert from 115-volt to 230-volt nominal line voltage or vice versa, pull out the Voltage line selector switch bar; turn it 180° and plug it back into the remaining holes. Change the line cord to fit the power source receptacle or use a line cord adapter.
4. It is not necessary to change fuses if the range is changed; however, in the 230 volt range both fuses are in use. Also in checking the fuses, the upper fuse (1/10 A) for the 115 volt range has a nominal resistance of approximately 80 ohms, and the lower fuse (1/16 A) for the 230 volt range has a nominal resistance of approximately 150 ohms.
5. Re-install the selector assembly cover and tighten the two captive screws.
6. Before applying power to the instrument, check that the indicating tab of the line selector is protruding through

the selector panel indicating that its position is proper for the applied nominal line voltage range (115 or 230). In the 115 volt nominal range, the regulating range is from 90 to 136 volts. In the 230 volt nominal range the regulating range is from 180 to 272 volts.

Handle and Stand

The bail-type handle of the Type 284 can be pulled out for convenient carrying of the instrument. When not in use, the handle folds out of the way into the trim of the instrument cabinet. See Fig. 2-1.

The bail-type stands are mounted beneath the cabinet. The stands permit the Type 284 to be tilted for convenient operation as shown in Fig. 2-1. The instrument may also be set on the rear feet either for operation or storage.

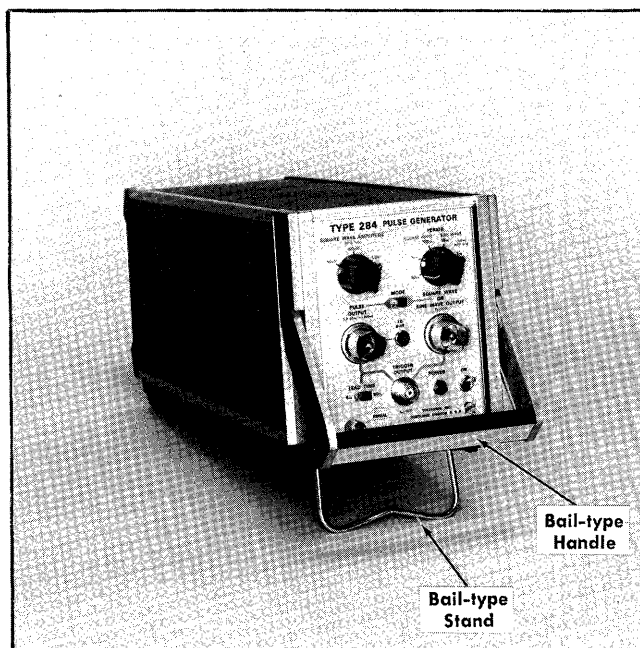
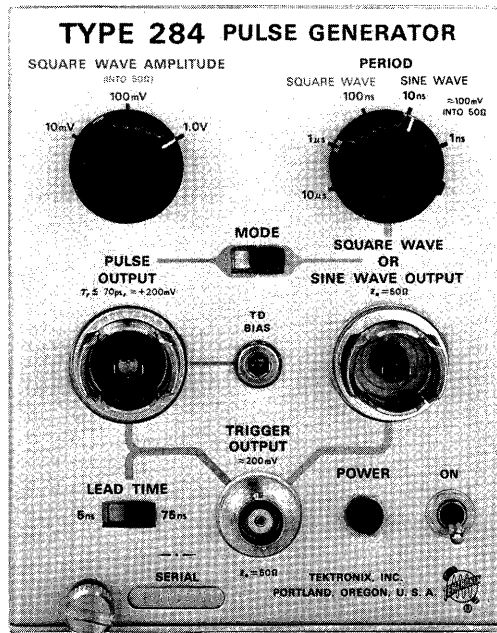

Fig. 2-1. Type 284 showing handle and stand.

CONTROLS AND CONNECTORS

A brief description of the function and operation of the front and rear panel controls and connectors follows. Fig. 2-2 shows the front and rear panels of the instrument. More detailed operation is given in this section under General Operating Information.



(A) Front Panel

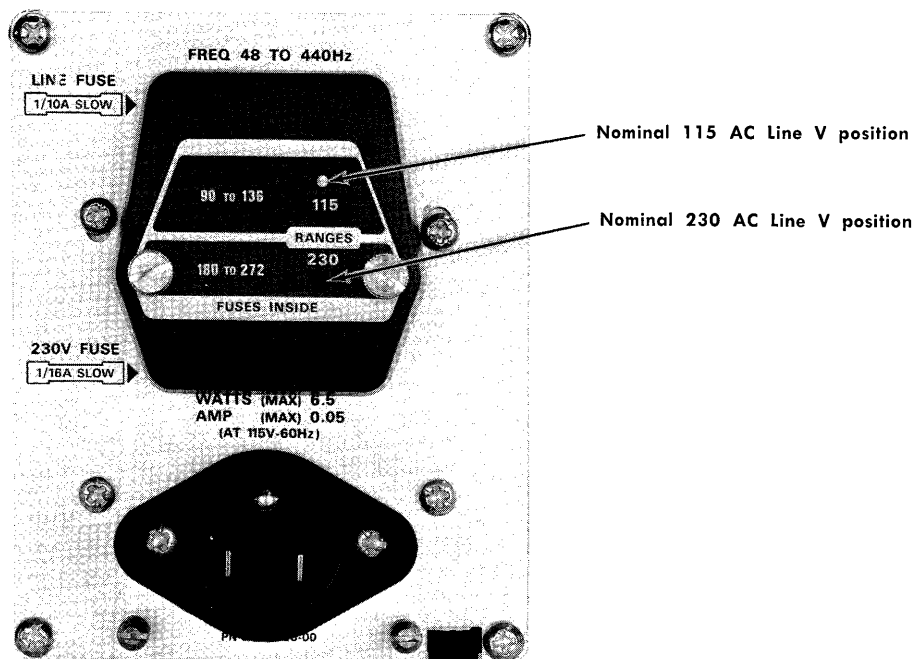

(B) Rear Panel

Fig. 2-2. Front and rear-panel controls and connectors.

Front Panel

SQUARE WAVE AMPLITUDE	Selects three amplitudes of square wave output signal voltages: 10 mV, 100 mV, and 1 V (into a 50 Ω load).
PERIOD	Selects the time periods of the SQUARE WAVE OR SINE WAVE outputs. The SQUARE WAVE output time periods are 10 μs, 1 μs and 100 ns with amplitude selected by the SQUARE WAVE AMPLITUDE switch. The SINE WAVE time periods are 10 ns and 1 ns with approximate amplitudes of 100 mV (into a 50 Ω load).
MODE	Selects either the PULSE OUTPUT or the SQUARE WAVE OR SINE WAVE OUTPUT to their respective connectors.
PULSE OUTPUT	Output connector for the PULSE OUTPUT (rise time ≤ 70 ps, amplitude ≥ 200 mV).
TD BIAS	Adjusts the bias of the tunnel diode affecting the PULSE OUTPUT.
LEAD TIME	Selects either 5 ns or 75 ns of LEAD TIME of the TRIGGER OUTPUT signal with reference to the PULSE OUTPUT signal.
TRIGGER OUTPUT	Output connector for the trigger signal pickoff, a portion of the signal from either the PULSE OUTPUT or the SQUARE WAVE OR SINE WAVE OUTPUT depending upon the position of the MODE switch.
SQUARE WAVE OR SINE WAVE OUTPUT	Output connector for the SQUARE WAVE OR SINE WAVE OUTPUT as selected by the SQUARE WAVE AMPLITUDE and PERIOD switches.
POWER	Light: Indicates when POWER switch is ON and the instrument is connected to a power source. Switch: Applies power to the instrument.

Rear Panel

Line voltage selector	Switching assembly to select the nominal operating voltage (115 V or 230 V). This assembly also includes the line fuses.
Power Connector	Input connector for line power.

FIRST-TIME OPERATION

The following steps will demonstrate the use of the controls and connectors of the Type 284. It is recommended that this procedure be followed for familiarization with this instrument. In this procedure a Tektronix Type 561A Oscilloscope is used with a Type 3S1 Dual-Trace Sampling Unit and a Type 3T2 Sampling Sweep Unit. If other equipment is used the control settings and the procedure will be different. If you are not familiar with the operation of the oscilloscope with its sampling plug-in units, read the First Time Operation portions of the manuals for these instruments before proceeding.

Setup information

1. Set controls as follows:

Type 284

SQUARE WAVE AMPLITUDE	1.0 V
PERIOD	10 μs
MODE	SQUARE WAVE OR SINE WAVE OUTPUT (to right)
LEAD TIME	5 ns

Type 3S1

Display Mode switch	Chan A
Smooth-Normal switch	Normal
A Position	Midrange
B Position	Midrange
DC Offset ±1 V, Channel A	Midrange (5 turns from one end)
DC Offset ±1 V, Channel B	Midrange (5 turns from one end)
mVolts/Div, Channel A	200
mVolts/Div, Channel B	200
Variable mVolts/Div (both channels)	Cal
Invert-Norm switch, Channel A	Norm
Invert-Norm switch, Channel B	Norm
Internal Trigger	Off
Sampling Mode	Triggered

Type 3T2

Time Position	Fully Clockwise
Time Position Fine	Fully Clockwise
Horiz Position	Midrange
Samples/Div	Midrange
Range	10 μs
Start Point	With Trigger
Display Mag	×1
Time Magnifier	×1
Time Magnifier Variable	Cal
Display Mode	Normal
Trigger Sensitivity	Fully Clockwise
Recovery Time	Midrange
Polarity	—
Source	Ext
Samples/Div (an Internal Switch)	100 (up position)

2. Connect the Type 284 to a power source that meets the voltage and frequency requirements of the instrument. Check to see that the plastic indicating tab on the line selector panel on the rear of the instrument is protruding through the selector panel indicating that its position is

Operating Instructions—Type 284

proper for the applied nominal line voltage (115 V or 230 V). See AC Power Considerations in this section for instructions to change the nominal line voltage if necessary.

3. Set the Power switch to ON on the Type 284 and also on the Test Oscilloscope, and allow five minutes warm up before proceeding.

Square wave output

4. Connect the Type 284 SQUARE WAVE OUTPUT signal through a $50\ \Omega$ coaxial cable with GR type connectors to the A input Connector on the Type 3S1. Connect the TRIGGER OUTPUT signal through a $50\ \Omega$ BNC type coaxial cable to the $50\ \Omega$ Trigger Input connector on the Type 3T2.

5. Turn the Trigger Sensitivity fully counterclockwise, then slowly clockwise until a stable display is obtained. See Fig. 2-3A. Normal slight changes of the Samples/Div control on the Type 3T2, the A Position control on the Type 3S1 may be necessary to display this waveform.

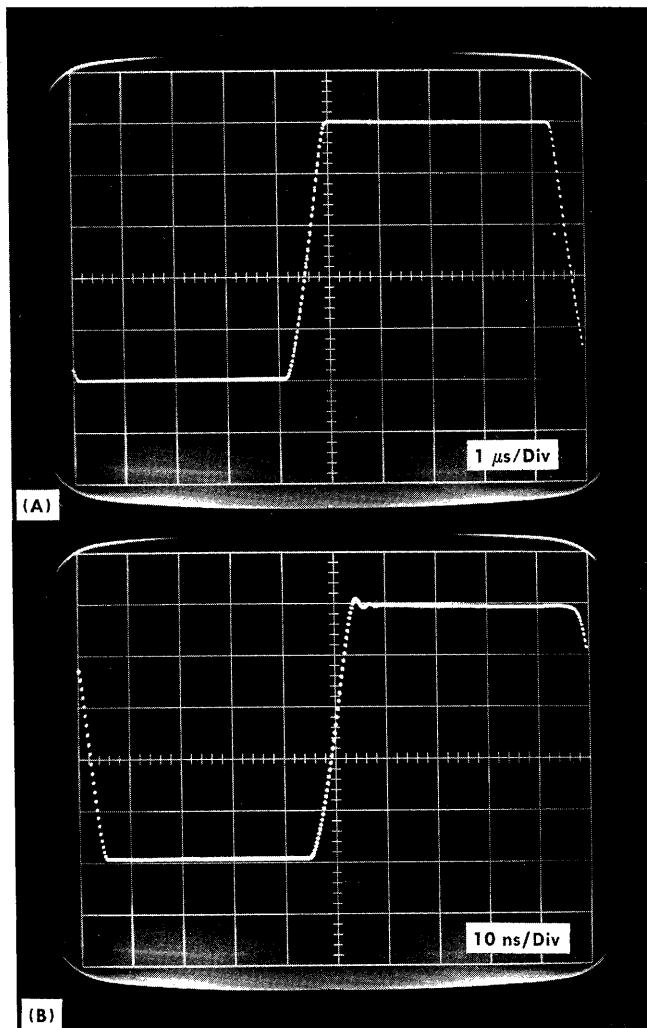

Fig. 2-3. Typical SQUARE WAVE OUTPUT display (1 Volt into $50\ \Omega$ load) for two time periods.

6. Change the Type 284 PERIOD switch to $1\ \mu\text{s}$ and change the Type 3T2 Range switch to $1\ \mu\text{s}$ (Time/Div 100 ns). Observe a similar display to that in preceding step.

7. Change the Type 284 PERIOD switch to 100 ns and change the Type 3T2 Range switch to 100 ns (Time/Div 10 ns). Observe a display similar to Fig. 2-3B.

8. Change the Type 284 SQUARE WAVE AMPLITUDE switch to 100 mV and change the Type 3S1 Channel A mVolts/Div switch to 50. Observe a 2 division display similar to the 5 division display in Fig. 2-3B.

9. Change the Type 284 SQUARE WAVE AMPLITUDE switch to 10 mV and change the Type 3S1 Channel A mVolts/Div switch to 5. Observe 2 divisions of display with the normal noise of the Type 3S1 showing up at this sensitivity.

Sine Wave Output

10. Move the trigger signal coaxial cable on the Type 3T2 from the $50\ \Omega$ input connector to the $1\ \text{M}\Omega$ /UHF Sync connector. Set the Type 284 PERIOD switch to 10 ns SINE WAVE and set the Channel A mVolts/Div switch on the Type 3S1 to 50. Slight change in the Trig. Sensitivity control on the Type 3T2, and in the A Position control on the Type 3S1 may be necessary to obtain a display similar to Fig. 2-4A.

11. Set the PERIOD switch to 1 ns SINE WAVE on the Type 284 and set the Time Magnifier switch on the Type 3T2 to $\times 10$ (Time/Div 1 ns). Observe the 1 ns period sine wave similar to Fig. 2-4B. Slight change in the Trig. Sensitivity control, and the Recovery Time control on the Type 3T2 may be necessary to obtain a stable display.

Pulse Output

12. Move the signal coaxial cable on the Type 284 to the PULSE OUTPUT connector, and set the MODE switch to the PULSE OUTPUT position (to the left). Set the Time Magnifier switch on the Type 3T2 to $\times 1$ (Time/Div 10 ns), and turn the Trig. Sensitivity switch fully counterclockwise then clockwise for a stable trace. Change the LEAD TIME switch to 75 ns position and note the change in delay time of approximately 70 ns as shown in Fig. 2-5B.

NOTE

Since the tunnel diode pulse generator is an integral part of the PULSE OUTPUT connector, mechanical strain on the PULSE OUTPUT connector will cause slight mechanical changes in the tunnel diode assembly. Slight adjustment of the TD BIAS control, a screwdriver adjustment on the front panel, will correct the display. For the TD BIAS adjustment procedure see the General Operating Instructions.

CONTROL SETUP CHART

Fig. 2-6 is a control setup chart for the front and rear panels of the Type 284. This figure may be reproduced and used as a test setup record for special applications or procedures. It may also serve as a training aid to facilitate control operation.

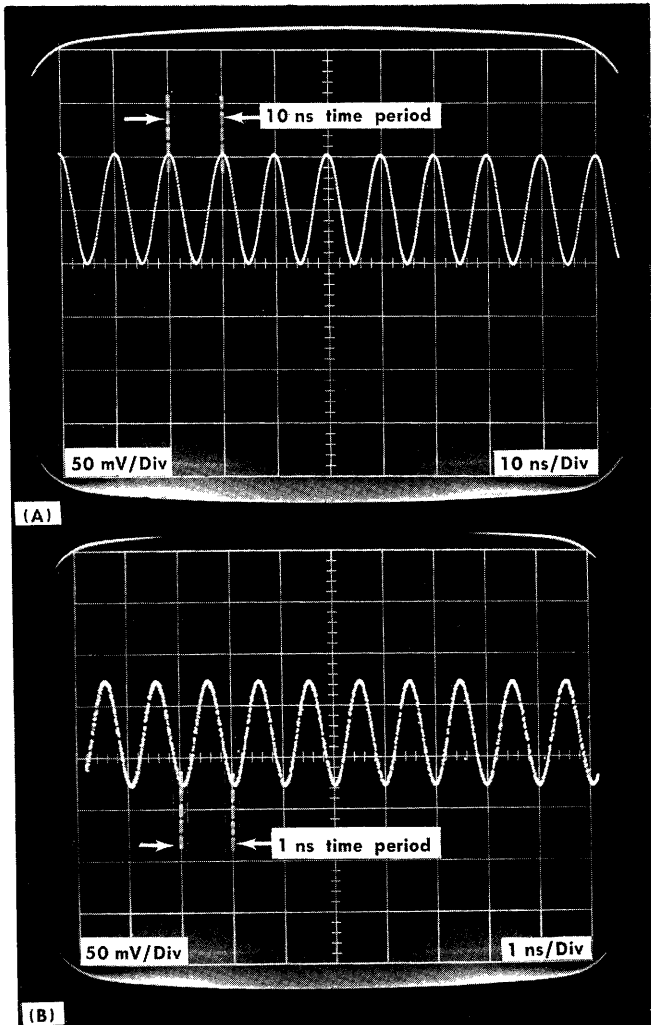

Fig. 2-4. Typical SINE WAVE OUTPUT display showing (A) 10 ns and (B) 1 ns time period.

GENERAL OPERATING INFORMATION

Mode Switch

The MODE switch selects one output with its trigger signal. The MODE switch always turns the power off on one output which prevents both trigger signals from appearing at the TRIGGER OUTPUT at the same time.

Square Wave Output

The SQUARE WAVE OUTPUT amplitude is selected by the SQUARE WAVE AMPLITUDE switch, and the time period is selected by the PERIOD switch on three of its positions. Note that the other two positions of the PERIOD switch select the SINE WAVE time period. In order to maintain the output selected by the SQUARE WAVE AMPLITUDE switch, an output load of 50 Ω is required. For further loads use the following formula to calculate the output voltage:

$$E_{out} = \frac{R_{load}}{R_{load} + 50} \times 2E \quad (1)$$

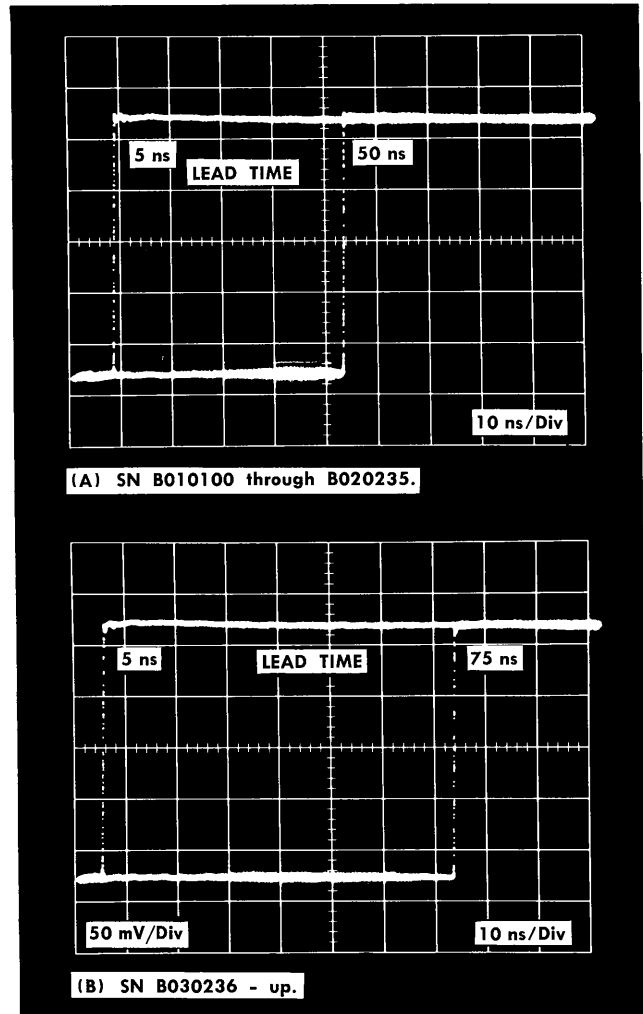

Fig. 2-5. Typical PULSE OUTPUT display, showing a double exposure of two positions of LEAD TIME switch.

(E is the Voltage selected by the SQUARE WAVE AMPLITUDE switch)

Fig. 2-7 shows the time period and amplitude measurement points. In this display the output of the Type 284 is properly terminated by being coupled to the 50 Ω input of a sampling oscilloscope. Disregard the overshoot at the top corner of the square wave in making amplitude measurements. The time period measurement (here a period of 100 ns) is the time of one cycle of the square wave.

The square wave output desired can be selected for amplitude from 1 V, 100 mV or 10 mV and for the time period from 10 μs, 1 μs or 100 ns.

Sine Wave Output

The SINE WAVE OUTPUT is selected by the PERIOD switch. The period switch selects either a 10 ns or a 1 ns sine wave time period. The time period is the time of one cycle of the sine wave. The amplitude is approximately 100 mV when it is connected into a 50 Ω load.

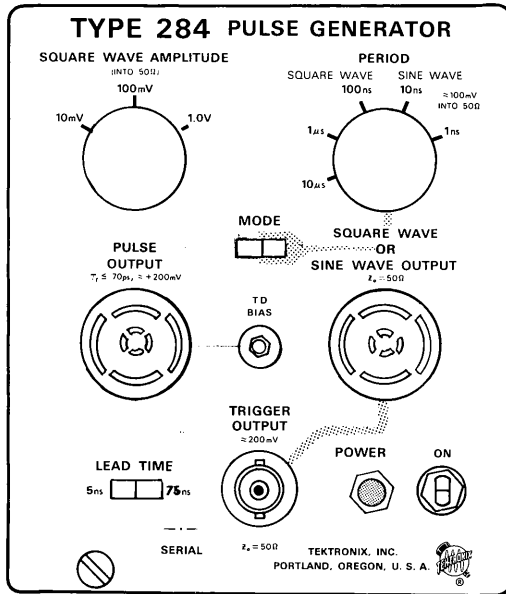

(A) FRONT PANEL

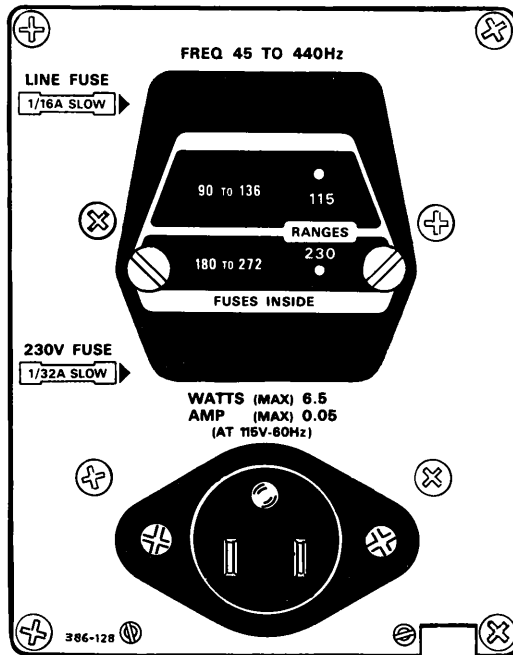

(B) REAR PANEL

Fig. 2-6. Control setup chart.

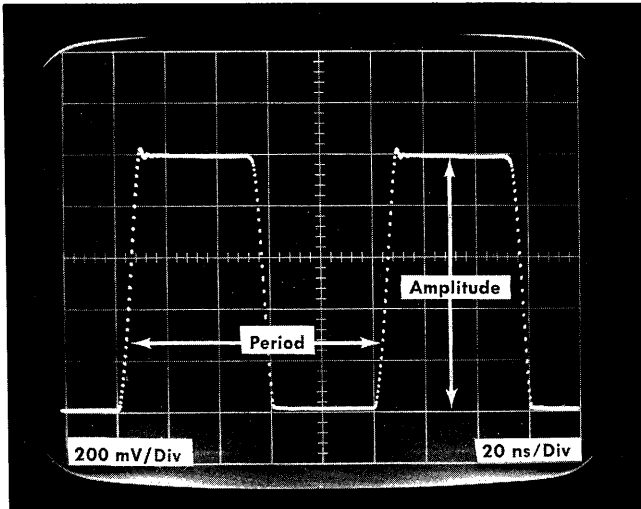

Fig. 2-7. Typical display showing amplitude and period measurements. A 1 Volt amplitude, 100 ns time period pulse from the Type 284 into 50 Ω input of Sampling oscilloscope.

Pulse Output

The Pulse Output power is turned on by setting the Mode switch to its left position. The pulse is generated by a tunnel diode in a coaxial environment and connected directly to the PULSE OUTPUT connector. A screwdriver adjustment marked TD BIAS (tunnel diode bias) on the front panel is used to adjust the optimum voltage of the tunnel diode. Mechanical strain on the front panel connector may change the tunnel diode environment and a slight adjustment of the TD BIAS may be necessary. To obtain the power adjustment of the TD BIAS, it is necessary to observe the display on a sampling oscilloscope. Following is a setup procedure using a Tektronix Type 561A with a Type 3S1 Dual-Trace Sampling Unit and a Type 3T2 Sampling Sweep Unit. If other equipment is used, the control settings and the procedure will be different.

NOTE

An internal TD Bias adjustment (R133) is provided for coarse adjustment of tunnel diode bias. If the tunnel diode is replaced or if the front panel control doesn't provide a satisfactory setting adjust the TD Bias (internal) in the manner given in the Calibration section of this manual.

1. Set the controls as follows:

Type 284

MODE switch	Pulse Output (to left)
LEAD TIME	5 ns
POWER	ON

Type 3S1

Display Mode switch	Chan A
Smooth-Normal switch	Normal
A Position	Midrange
DC Offset ±1 V, Channel A	Midrange (5 turns from one end)

mVolts/Div, Channel A	50
Variable mVolts/Div (Channel A)	Cal
Invert-Norm switch, Channel A	Norm
Sampling Mode switch	Triggered

Type 3T2

Time Position	fully clockwise
Time Position Fine	fully clockwise
Horiz Position	Midrange
Samples/Div	Midrange
Range	100 ns
Start Point	with Trigger
Display Mag	×1
Time Magnifier	×1
Time Magnifier Variable	Cal
Display Mode	Normal
Trigger Sensitivity	Fully clockwise
Polarity	+
Source	Ext
Samples/Div (an internal switch)	100 (up position)

2. Connect the Type 284 PULSE OUTPUT signal through a 50 Ω coaxial cable with GR type connectors to the A input connector on the Type 3S1. Connect the TRIGGER OUTPUT signal through a 50 Ω BNC type coaxial cable to the 50 Ω Trigger Input connector on the Type 3T2.

3. If the TD BIAS is at optimum adjustment you will observe an untriggered display of about 4 divisions or about 200 mV peak to peak as in Fig. 2-8A, and upon turning the Trigger Sensitivity control almost fully counterclockwise, observe a clean triggered step display similar to Fig. 2-8B. Normal slight changes to the Type 3T2 Samples/Div control and the Type 3S1 A Position control may be necessary to display this waveform.

4. If upon turning the Trigger Sensitivity control almost fully counterclockwise a trace display appears showing the position of the upper portion of the pulse, this indicates that the TD BIAS control is clockwise from the optimum adjustment. See Fig. 2-8C (upper trace). Slight counterclockwise rotation of the TD BIAS control will be necessary to obtain a display similar to Fig. 2-8B.

5. Fig. 2-8C (lower trace) display indicates that the TD BIAS control is counterclockwise from the optimum adjustment. If the display as in Fig. 2-8B cannot be attained with clockwise rotation of TD BIAS control, refer to the calibration section of this manual.

The PULSE OUTPUT of the Type 284 has an amplitude of approximately +200 mV into a 50 Ω load. The pulse width is approximately 1 μs out of a pulse period of about 20 μs. The rise time of the pulse is equal to or less than 70 ps. With these specifications, several precautions should be considered when connecting the Type 284 PULSE OUTPUT signal to a test device or to a display oscilloscope.

Cable Considerations

The cables that conduct the output to the device under test should be low-loss 50 Ω coaxial cables to assure that all information contained in the pulse will be delivered to the test point without distortion. The physical and electrical

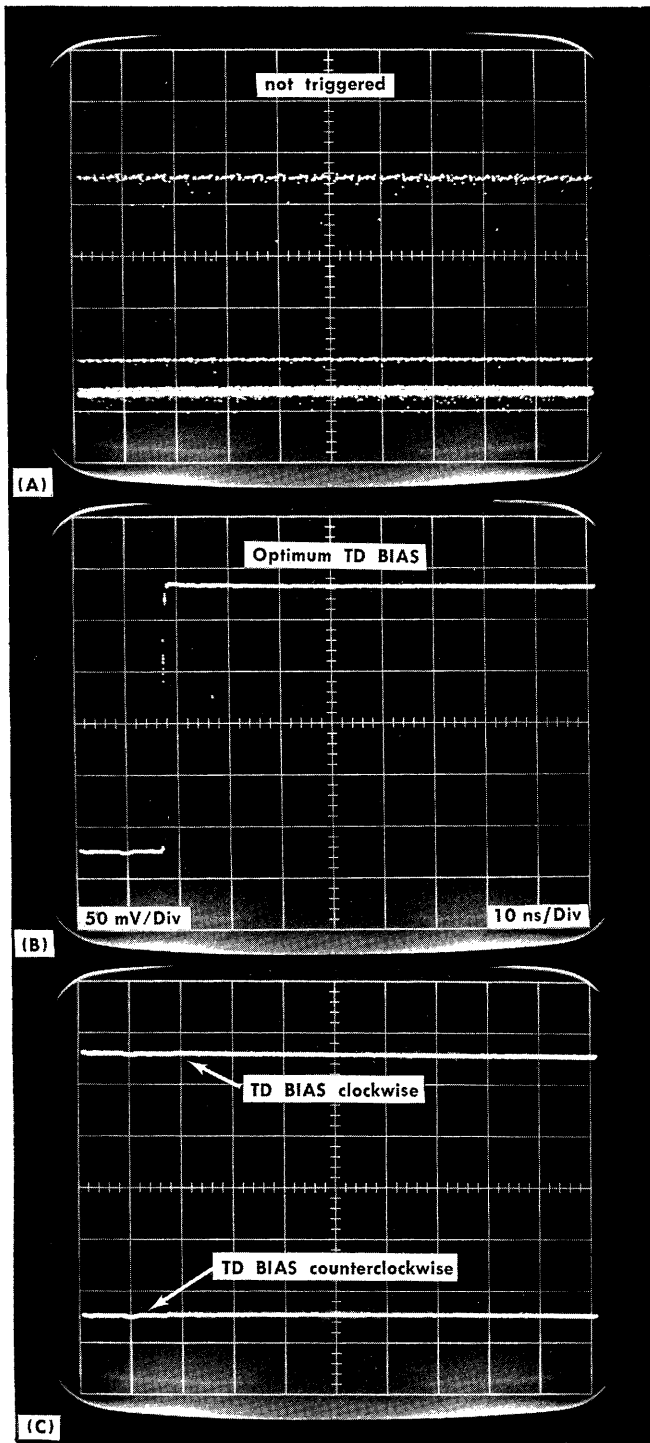

Fig. 2-8. Typical display showing adjustment of TD BIAS control.

characteristics of the cable determine the characteristic impedance, velocity of propagation and nature of signal loss. Since the signal losses caused by energy dissipation in the dielectric are proportional to the signal frequency, any very high frequency information in a fast-rise pulse will be lost in a very few feet of cable. Therefore it is important to use cables or airlines that are as short as possible.

Impedance Matching

To provide a smooth transition between devices of different characteristic impedance, each device must encounter a total impedance that is equal to its own characteristic impedance. Thus, when the OUTPUT PULSE signal of the Type 284 is applied to a load other than 50 Ω, a suitable impedance matching device must be provided. If the impedances are not matched, reflections and standing waves in the cables will result in distortion of the signal at the load. In many cases the load required will be 50 Ω, then with the use of available attenuators, 2×, 5× and 10× (10× Attenuator, Tektronix Part No. 017-0078-00) will attenuate the signal and provide the impedance match.

Fig. 2-9 illustrates a simple resistive impedance-matching network that provides minimum attenuation. To match impedances with the network, the following conditions must exist:

$$\frac{(R_1 + Z_2) R_2}{(R_1 + Z_2) + R_2} \text{ must equal } Z_1; \text{ and } R_1 + \frac{Z_1 R_2}{Z_1 + R_2} \text{ must equal } Z_2.$$

Therefore:

$$R_1 R_2 = Z_1 Z_2 \text{ and } R_1 Z_1 = R_2 (Z_2 - Z_1) \\ \text{or } R_1 = Z_2 (Z_2 - Z_1); \\ \text{and } R_2 = Z_1 \frac{Z_2}{Z_2 - Z_1}$$

As an example, to match a 50-ohm system to a 125-ohm system:

$$Z_1 = 50 \text{ ohms; and } Z_2 = 125 \text{ ohms.}$$

Therefore:

$$R_1 = 125 (125 - 50) = 96.8 \text{ ohms}$$

$$R_2 = 50 \frac{125}{125 - 50} = 64.6 \text{ ohms}$$

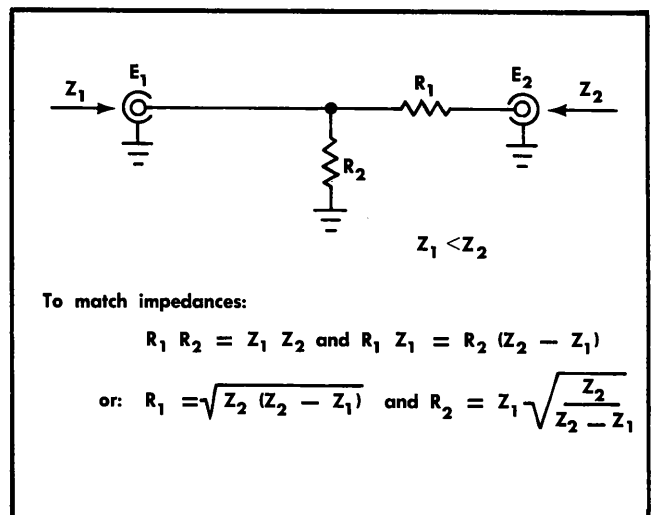

Fig. 2-9. Simple resistive impedance-matching network providing minimum attenuation.

Though the network in Fig. 2-9 provides minimum attenuation for a purely resistive impedance-matching device, the attenuation as seen from one end does not equal that seen from the other end. A signal applied from the lower impedance source (Z_1) encounters a voltage attenuation (A_1) that may be determined as follows:

$$\text{Since: } I_{R1} = I_{Z2}; \frac{E_1 - E_2}{R_1} = \frac{E_2}{Z_2}$$

$$\text{Therefore: } A_1 = \frac{E_1}{E_2} = \frac{R_1}{Z_2} + 1; (1 < A_1 < 2)$$

A signal applied from the higher impedance source (Z_2) will encounter a greater voltage attenuation (A_2) that may be determined similarly:

$$\text{Since } I_{R1} = I_{R2} + I_{Z1}; \frac{E_2 - E_1}{R_1} = \frac{E_1}{R_2} + \frac{E_1}{Z_1}$$

Therefore:

$$A_2 = \frac{E_2}{E_1} = \frac{R_1}{R_2} + \frac{R_1}{Z_1} + 1; (1 < A_2 < \frac{2Z_2}{Z_1})$$

In the example of matching 50 ohms to 125 ohms,

$$A_1 = \frac{96.8}{125} + 1 = 1.77;$$

$$\text{and } A_2 = \frac{96.8}{64.6} + \frac{96.8}{50} + 1 = 4.44$$

Note that if the 50-ohm source were used for pulsing a high-impedance load, R_1 would approximately equal the impedance of the load (high R) and R_2 would approximately equal the 50 ohms of the pulse source. In this situation, voltage attenuation would be about 2.

If a low-impedance load (< 50 ohms) were to be encountered, the 50-ohm pulse source would be the Z_2 source. If the load impedance were to approach 0 ohms, the value of R_1 would then approach the load impedance (low R). Voltage attenuation in this case would become quite significant;

$$\text{Attenuation} = \frac{2Z_2}{Z_L} = \frac{100}{Z_L} \text{ (very high)}$$

The illustrated network can be modified to provide different attenuation ratios by adding another resistor ($< R_1$) in series between Z_1 and the junction of R_1 and R_2 .

Risetime Considerations

If the PULSE OUTPUT signal from the Type 284 is to be used for determining the risetime of a test device or a display oscilloscope, the risetime of the Type 284 may have to be taken into consideration. Generally the risetime of the applied pulse (Type 284 PULSE OUTPUT) should be four times or more faster than the risetime to be measured. If the risetime of the applied pulse approaches the risetime of the system under test the actual risetime may be approximated from the following equation:

$$T_r \text{ measured} \approx (T_r \text{ pulse})^2 + T_r \text{ (system)}^2 \quad (2)$$

Calculations are not necessary if the oscilloscope system or device system under test or a combination of the device system under test and the oscilloscope system has a risetime of more than four times the applied pulse (70 ps—Type 284) or 280 ps. The above system includes a short coaxial

connecting cable and matching attenuators. For long coaxial cables, a display measurement is recommended because of the losses introduced by different types of cables.

Trigger Output

The TRIGGER OUTPUT signal is selected with the MODE switch at the same time and synchronized with either the PULSE OUTPUT or the SQUARE WAVE OR SINE WAVE OUTPUT. The amplitude of the TRIGGER OUTPUT signal is about 200 mV into a 50 Ω load in all positions. With the SQUARE WAVE OUTPUT, the 200 mV square wave trigger signal facilitates easy triggering, especially for the 10 mV SQUARE WAVE AMPLITUDE. The TRIGGER OUTPUT signal is a 1 or 10 ns sine wave, when the PERIOD and the MODE switch are selected for 1 or 10 ns SINE WAVE OUTPUT.

With the MODE switch in the PULSE OUTPUT position, the TRIGGER OUTPUT signal leads the PULSE OUTPUT signal by 5 ns or 75 ns as selected by the LEAD TIME switch. See Fig. 2-10.

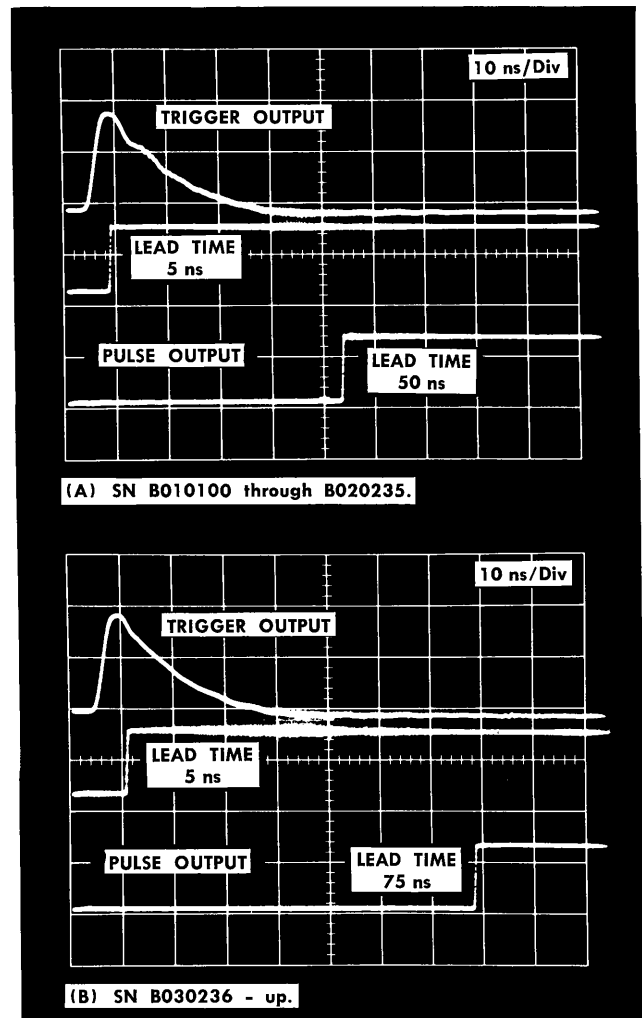

Fig. 2-10. Typical display showing TRIGGER OUTPUT signal, with PULSE OUTPUT signal in two positions of the LEAD TIME switch.

BASIC APPLICATIONS

General

The Type 284 is a source of Square Wave, Sine Wave and Pulse output signals useful to verify the deflection factor and timing accuracies of Sampling Oscilloscopes. It is also useful as a signal source for other applications. This part of the operating instructions will show basic uses of the Type 284.

Checking Amplitude

The Type 284 SQUARE WAVE OUTPUT signal amplitudes are 1 V, 100 mV, and 10 mV into 50 Ω with a selection of the time PERIOD of 10 μs, 1 μs, and 100 ns.

Fig. 2-11A shows Type 284 connected to the Channel A input of the Type 3S1 Dual Trace Sampling Unit, used in the Type 561A Oscilloscope with the Type 3T2 Sampling Sweep Unit. The vertical deflection factor of other 50 Ω input oscilloscope can be checked with this simple connection. Since the Type 284 uses the input of the Sampling unit as a load, the accuracy of the voltage presented to the input depends upon the accuracy of the input resistance. The DC input resistance can be measured with an accurate bridge with the oscilloscope power off. If external attenuators are used, their accuracies must be taken into account. Externally triggering the sampling oscilloscope from the Type 284 permits higher trigger amplitude (200 mV) with 100 mV and 10 mV square wave output.

Fig. 2-11B shows a method of connecting into sampling oscilloscopes with a high impedance input or sampling probe. The Type VP-2 voltage pickoff adapter permits use of the high impedance sampling probe to look at signals within a closed 50 Ω system, with a minimum effect upon the signal. Then by using an accurate end line termination with the VP-2, accurate amplitudes are conveyed to the Sampling Probe. Other high impedance input oscilloscopes can be checked with the Type 284 if an accurate 50 Ω termination is provided and the proper adapter is connected to the oscilloscope input.

Fig. 2-11C shows a typical display of a 1 Volt Square Wave Output 100 ns signal used in checking the vertical deflection of the sampling units.

Checking Equivalent Time Bases

Signals available from the Type 284 for checking time bases include square waves with time periods of 10 μs, 1 μs, and 100 ns, and sine waves with time periods of 10 ns and 1 ns. The amplitude of the signal is not important in checking equivalent time bases as long as the signal is adequate to obtain a stable display; however, with the SQUARE WAVE output, amplitude as well as time verification can be made.

An example of fast verification of the amplitude and time checks is shown with the Type 1S2 Sampling Plug-In Fig. 2-12B. A display is shown of the Type 284 SQUARE WAVE OUTPUT of 1 volt amplitude at a time period of 100 ns. The SQUARE WAVE signal is connected through a 50 Ω coaxial cable to one of the Thru Signal Channel 50 Ω connectors on the Type 1S2. The other Thru Channel 50 Ω connector is terminated with the End Line termination (Tektronix Part No. 017-0083-00). The Trigger Output signal from the Type 284 is connected through a BNC coaxial cable and a BNC to GR adapter to the Ext. Trig Input connector on the Type 1S2. See Fig. 2-12A.

Fig. 2-12C is a display of the 10 ns PERIOD SINE WAVE on the Type 1S2. The Type 1S2 is set for 10 ns/Div (Horizontal Units) with .05 Volts/Div (Vertical Unit).

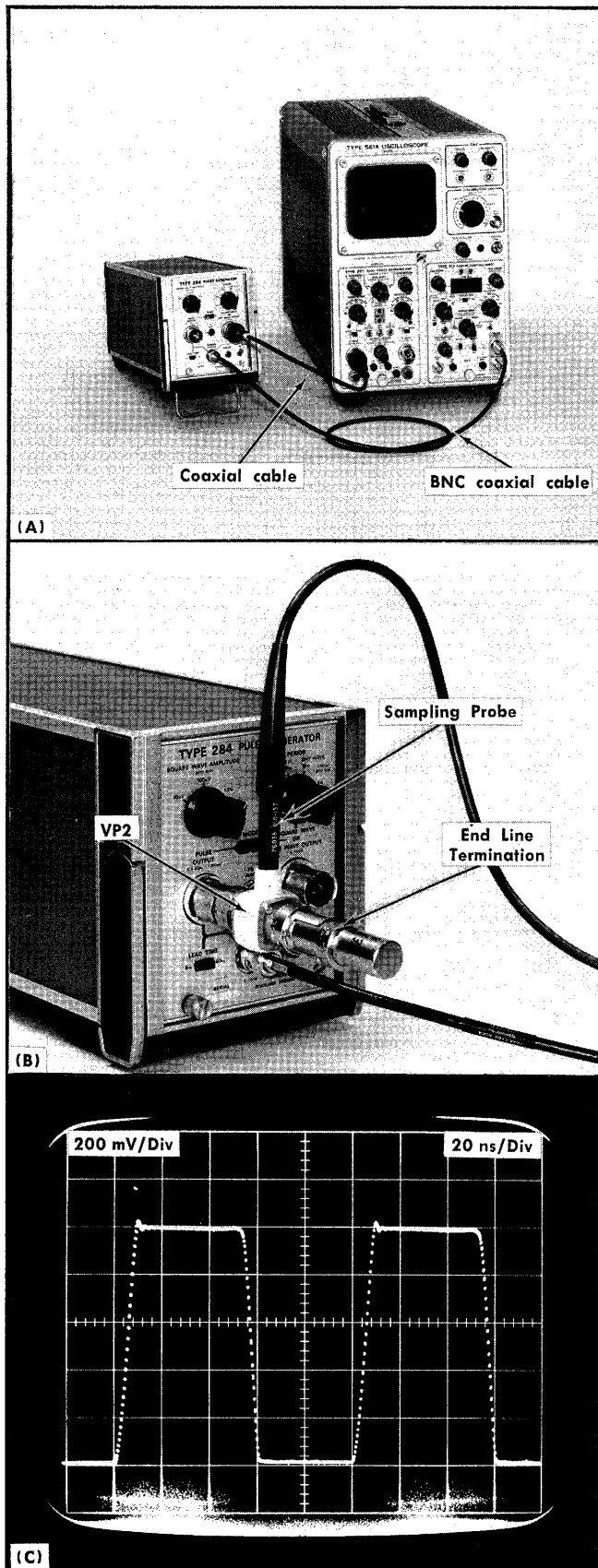

Fig. 2-11. Setup for Amplitude checks for (A) 50 Ω system, (B) Sampling Probe and (C) Typical waveform.

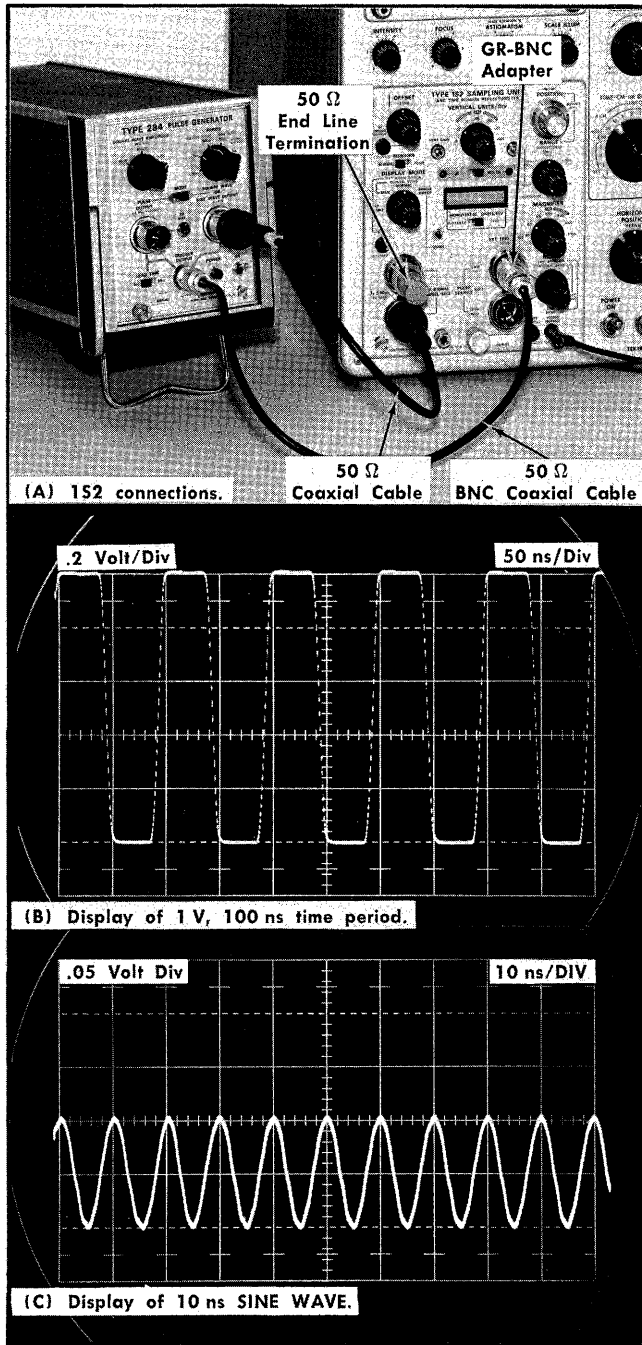

Fig. 2-12. Setup for display showing timing and Amplitude measurements for Type 152.

Checking Risetime

The Pulse output from the Type 284 has a risetime of ≤ 70 ps, a width of about $1 \mu s$, and a repetition rate of about 50 kHz. Risetime verification of Vertical Sampling units with risetimes equal to or longer than four times the Type 284 applied pulse can be made without calculations. At four times greater risetime, the error (by using equation 2 in this

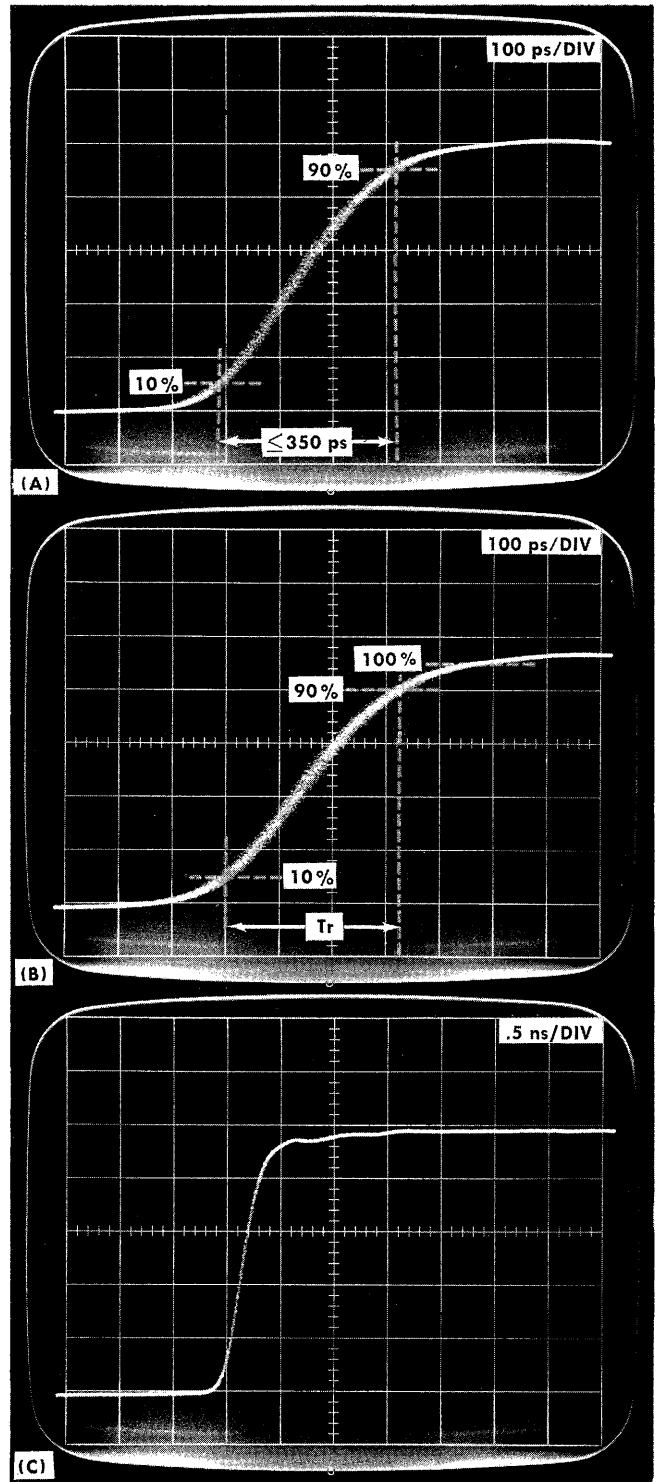

Fig. 2-13. Typical displays showing risetime checks.

section) is +3% of the displayed signal. Four times 70 ps (Type 284 risetime) or about 280 ps, or slower risetime verticals units can be verified directly.

Fig. 2-13A shows a typical display with the Type 284 Pulse Output signal connected through a 5 ns coaxial cable to one input connector of the Type 3S1. A Type 561A Oscilloscope with a Type 3T77A Sampling Sweep Unit was used with the

Operating Instructions—Type 284

Type 3S1. The risetime is verified from 10% to 90% of the full amplitude to be equal to or less than 350 ps. Fig. 2-13B shows a display of the Pulse Output signal fed through a 60 ns 50 Ω coaxial cable. Here the measurement of the display risetime is taken from the 10% to 90% points of a lower amplitude. The Pulse does not reach full amplitude in this display of 100 ps/div.

By changing the equivalent time to 5 times slower or .5 ns/div, note the long, gradual slope (Fig. 2-13C) after the initial rise in the waveform. This distortion is referred to as "dribble up" characteristic of the coaxial cable. The risetime is measured from the 10% to the 90% points of the initial ramp portion of the displayed signal not including the dribble up portion. The risetime, dribble up and other characteristics of coaxial cables can be evaluated with a known risetime generator and sampling oscilloscope system.

Risetime verification of a system including the display oscilloscope whose risetime approaches the risetime of the Type 284 applied pulse, can be approximated by equation (2) in this section.

Checking Fast Oscilloscope Vertical Response to a Fast Step Pulse

A fast step pulse will show up various responses in amplifiers due to terminations, mechanical layout, and characteristics of input circuits. The following displays (Fig. 2-14 through 2-21) were taken showing the characteristics of some vertical amplifiers when subjected to the Type 284 Pulse. The Pulse Output signal of the Type 284 is connected through a 20 Cm, 50 Ω Airline (Tektronix Part No. 017-0084-00) to the 50 Ω input sampling oscilloscopes. External triggering was used with the trigger signal from the Type 284 Trigger output connector through a BNC coaxial cable to the External Input of the sampling sweep unit. With the sampling probe type of sampling oscilloscopes, the output of the Type 284 is connected to a Type VP-2, and an End Line Termination (Tektronix Type 017-0081-00). The Sampling Probe was inserted in the Type VP-2.

Other high impedance oscilloscopes required an accurate 50 Ω termination and an adapter to connect to the input.

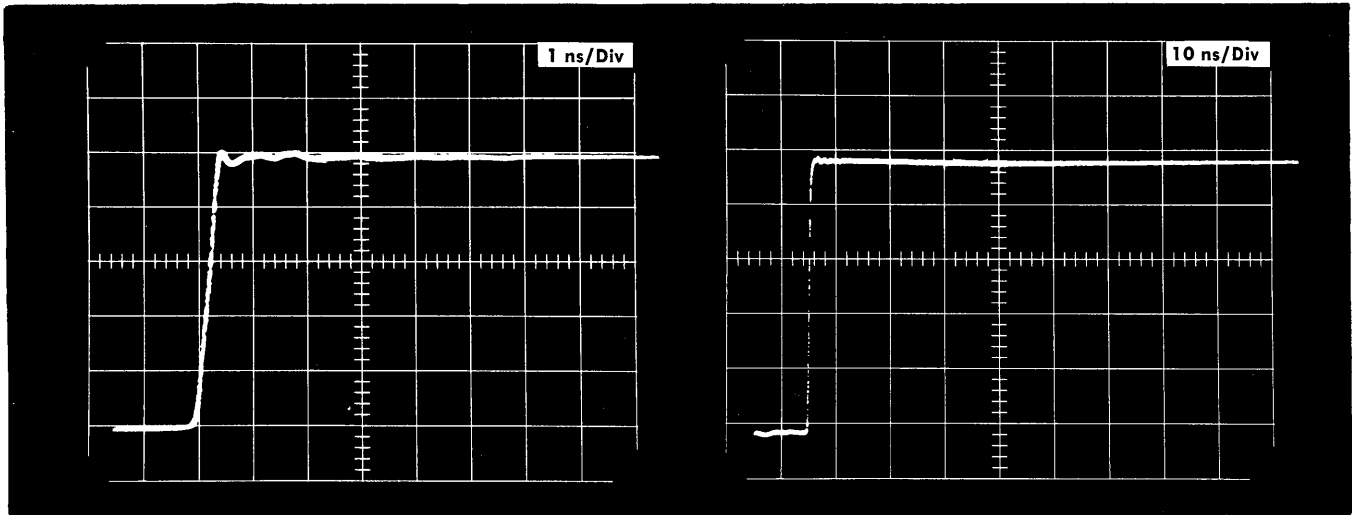

Fig. 2-14. Typical Type 284 PULSE OUTPUT signal display using Type 4S1 Vertical Sampling Unit.

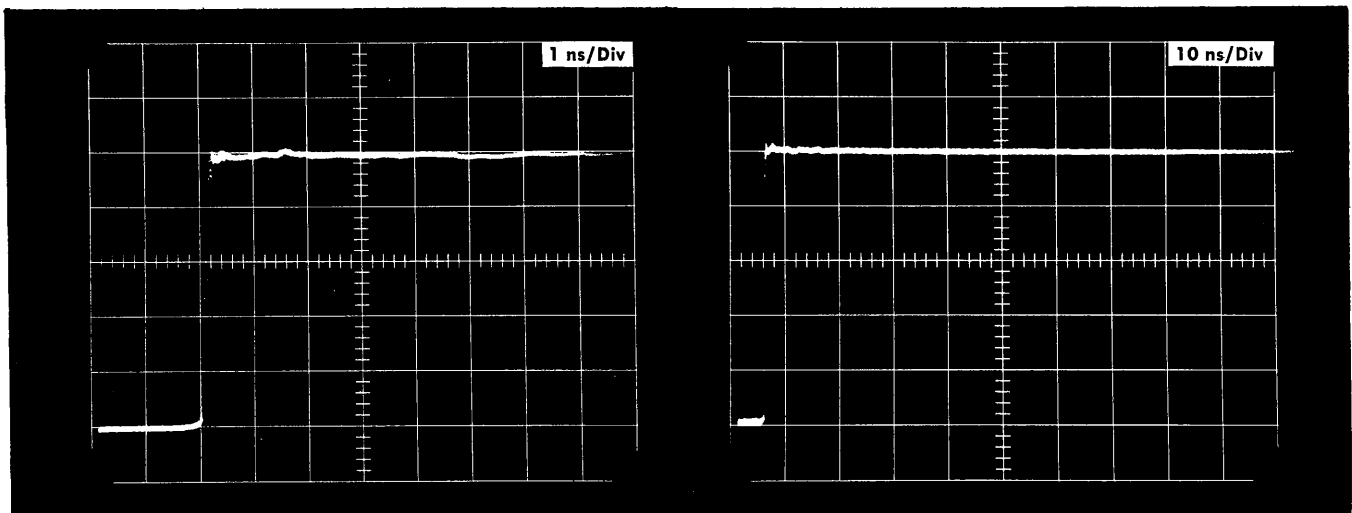

Fig. 2-15. Typical Type 284 PULSE OUTPUT signal display using Type 4S2A Vertical Sampling Unit.

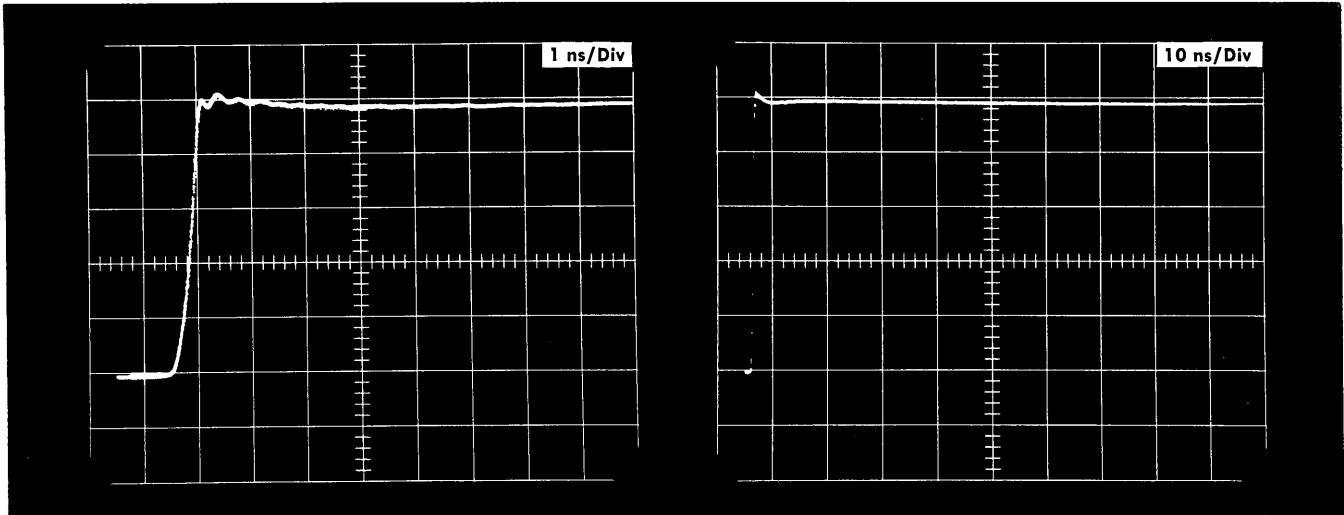

Fig. 2-16. Typical Type 284 PULSE OUTPUT signal display using Type 453 Vertical Sampling Unit.

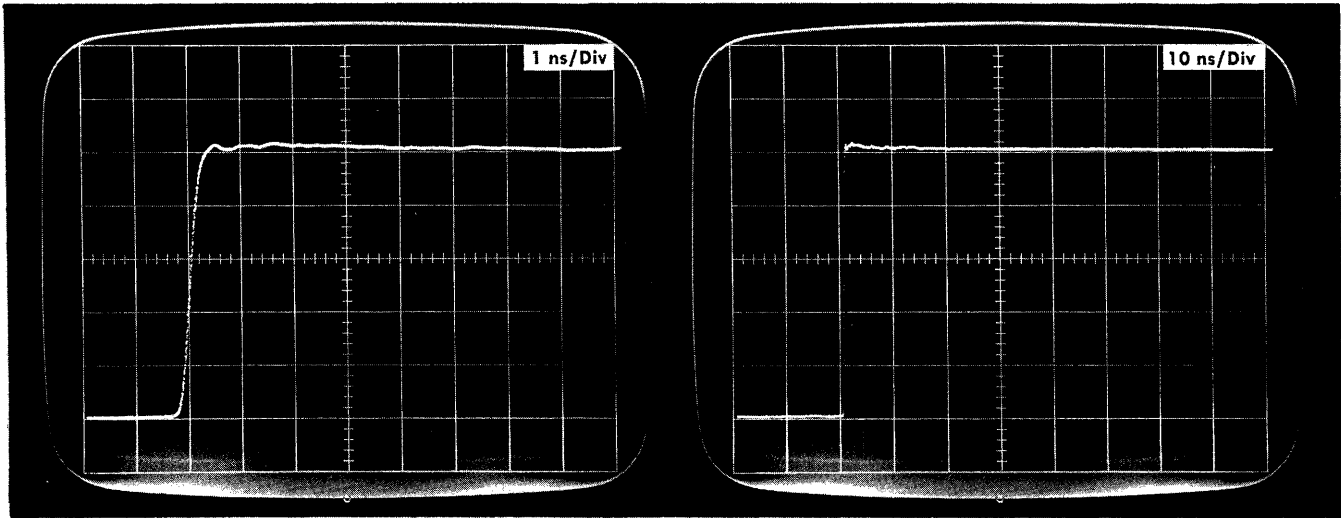

Fig. 2-17. Typical Type 284 PULSE OUTPUT signal display using Type 351 Vertical Sampling Unit.

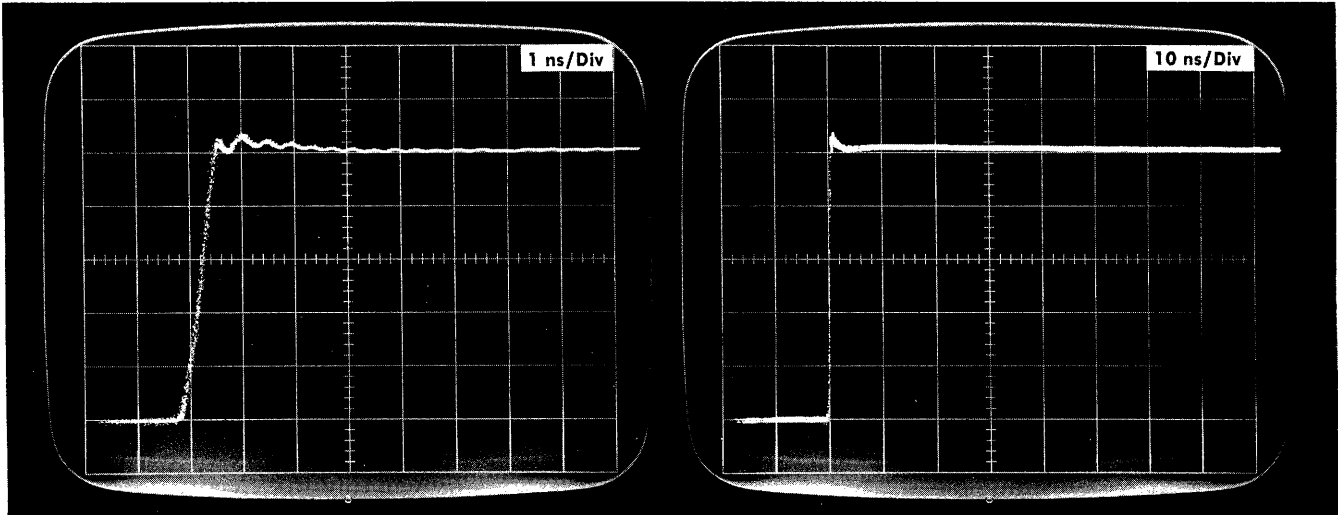

Fig. 2-18. Typical Type 284 PULSE OUTPUT signal display using Type 353 Vertical Sampling Unit.

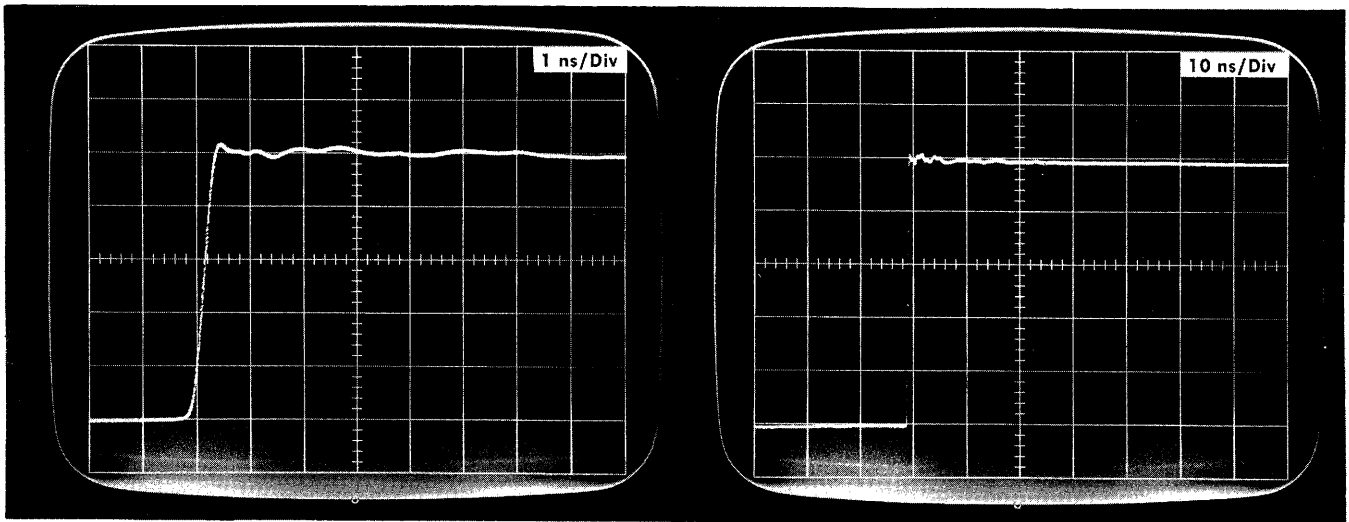

Fig. 2-19. Typical Type 284 PULSE OUTPUT signal display using Type 3576 Vertical Sampling Unit.

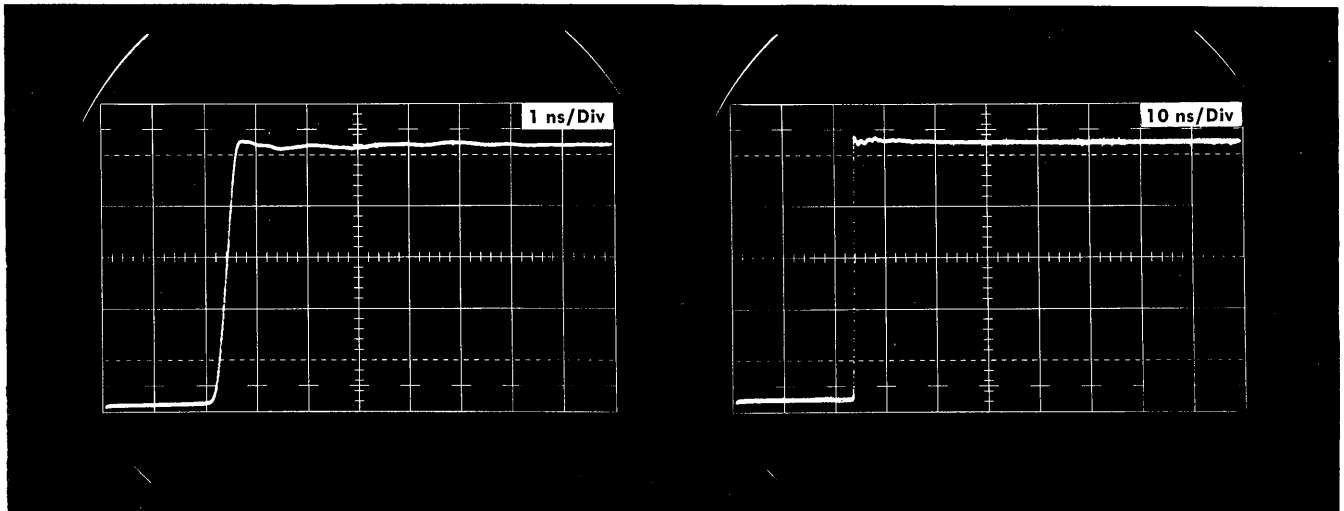

Fig. 2-20. Typical Type 284 PULSE OUTPUT signal display using Type 151 Sampling Unit.

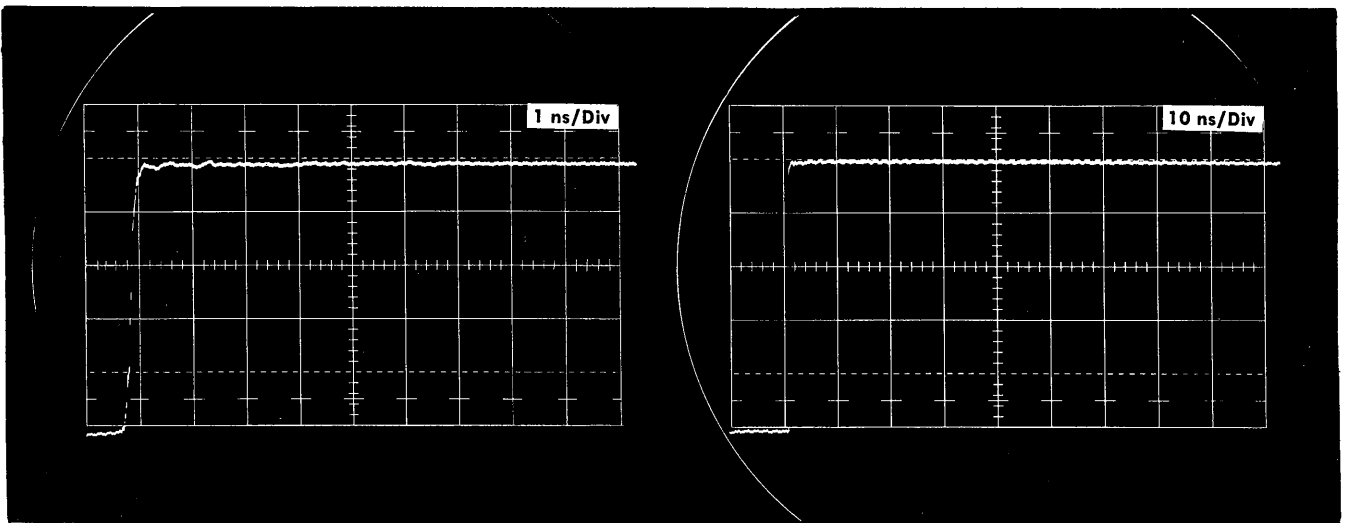

Fig. 2-21. Typical Type 284 PULSE OUTPUT signal display using Type 152 Reflectometer and Sampling Unit.

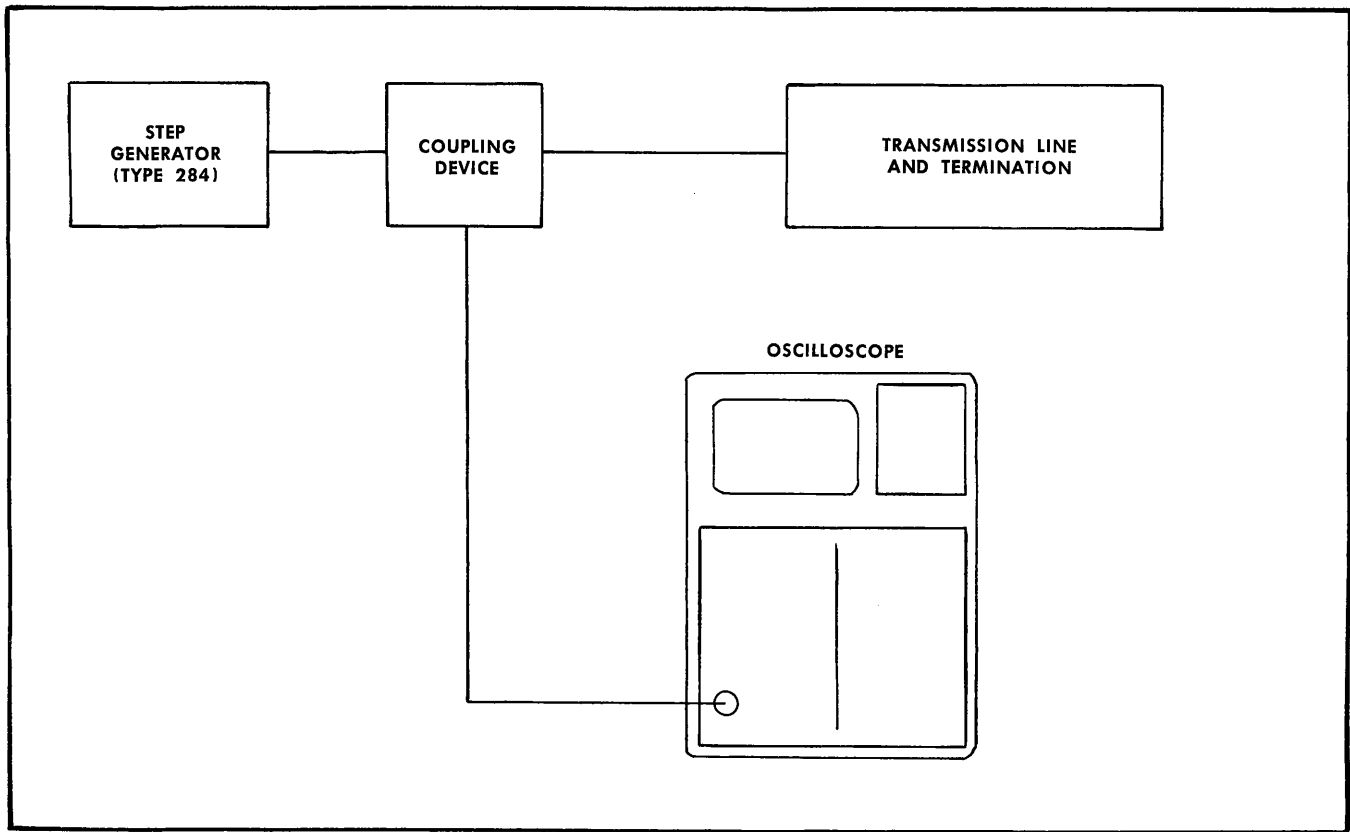

Fig. 2-22. A Time Domain Reflectometry (TDR) system.

TDR APPLICATIONS

Introduction

This part of the operating instructions contains information on the use of the Type 284 for Time Domain Reflectal Units) with .05 Volts/Div (Vertical Unit).

ometry (TDR). It consists of basic TDR theory and how to calibrate two 50 Ω systems.

Basic TDR Theory

TDR is useful for measuring transmission line characteristic impedance, signal propagation velocity, losses, termination resistance and the location of discontinuities within a transmission line. It can be used to measure discrete capacitors, inductors, and resistors, and identify their spatial location. It can measure the resistance and inductance per turn of ferrite cores and measure the output resistance of signal sources and the input resistance of amplifiers.

A typical TDR system (Fig. 2-22) consists of 1) a step-signal generator, 2) a coupling device, 3) the transmission line under test and its output load, and 4) an oscilloscope to monitor the voltage at the transmission line input.

Limitations of a TDR system depend upon 1) the capabilities of the step generator to provide a fast-risetime, low distortion pulse, 2) the fidelity of coupling the step signal to the transmission line and the oscilloscope, 3) resistive and high frequency losses of the transmission line, and 4) oscillo-

scope sweep rate, risetime, sensitivity and noise, each affecting its ability to monitor the reflected signals accurately.

A simple DC analogy of a TDR system is shown in Fig. 2-23. The battery represents the open circuit voltage of the step generator; R_g is the internal generator resistance, and R_L is the transmission line characteristic impedance. Closing the switch provides a fast-rise voltage step to the transmission line R_L .

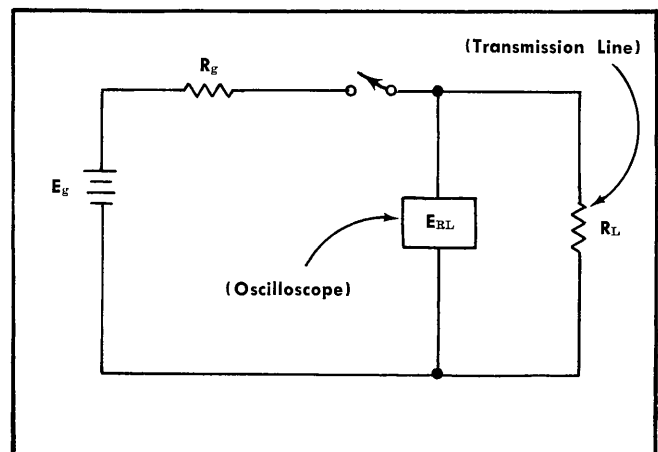

Fig. 2-23. Circuit showing DC analog of TDR.

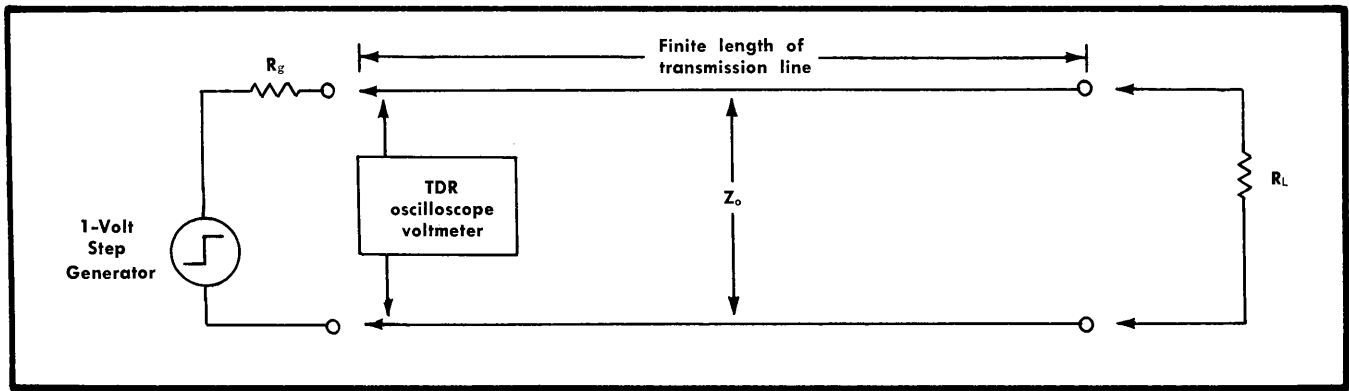

Fig. 2-24. Adding the time dimension to the circuit of Fig. 2-23.

When the switch is closed, R_g and R_L form a voltage divider across the battery terminals. The voltage across R_L is then stated by formula (3);

$$E_{RL} = \frac{R_L}{R_g + R_L} \times E_g \quad (3)$$

Formula (3) shows that a change in R_L directly changes E_{RL} . Since E_{RL} is the voltage observed by the oscilloscope, any change in R_L (the impedance of the transmission line) will produce a change in oscilloscope vertical deflection. In formula (3) we assume that R_g is equal to R_L , and that E_{RL} is not loaded by the oscilloscope. However, these factors are considered in the coupling device in Fig. 2-22. Consider R_L shorted, then E_{RL} will be zero. Conversely consider R_L open, then E_{RL} will be equal to E_g (the open circuit generator voltage).

Adding the Time Dimension

Fig. 2-24 substitutes a step generator for the battery and switch of Fig. 2-23. The step generator and R_g drive a finite length (lossless) transmission line has a characteristic impedance of Z_o . The transmission line has output terminals that permit connecting a load R_L . An oscilloscope voltmeter measures the voltage signal(s) at the input end of the transmission line.

Assume that no load resistance is connected to the transmission line output terminals ($R_L = \infty$) and that $R_g = Z_o$ (Z_o acts exactly as if it were a DC resistor). As the step generator applies its 1-volt step signal to R_g , the oscilloscope voltmeter indicates 0.5 volt. The oscilloscope voltmeter will continue to indicate a 0.5 volt signal until the wave has traveled down the line to the open end, doubled in amplitude due to no current into R_L ($R_L = \infty$) and is then reflected back to the generator end of the line. The oscilloscope finally indicates a signal of 1 volt after the measurable period of time required for the step signal to travel down and back the finite length of open ended transmission line.

Reflection Signal Amplitudes

Fig. 2-25 shows TDR oscilloscope (voltmeter) displays related to the value of R_L vs the value of the transmission line Z_o . For values of R_L not equal to Z_o , use formula (3) to compute the reflection voltage. The final display voltage is the re-

flection voltage algebraically added to the incident step voltage.

A more convenient method of handling signal reflections is to consider the reflection as having been added to or subtracted from the incident pulse. This permits establishing a ratio between the incident and reflected signals which is called the reflected coefficient, rho (ρ). The value of ρ is simply the reflected pulse amplitude (the display total amplitude minus the incident pulse amplitude) is divided by the incident pulse amplitude. Fig. 2-25 shows the two parts of the display, the incident step and the reflected signal. When $\rho = 0$, the transmission line is terminated in a resistance equal to its characteristic impedance Z_o . If the line is terminated in $R_L > Z_o$, then ρ is positive. If the line is terminated in $R_L < Z_o$, the ρ is negative. The dependence of ρ on the transmission line load is

$$\rho = \frac{R_L - Z_o}{R_L + Z_o} \quad (4)$$

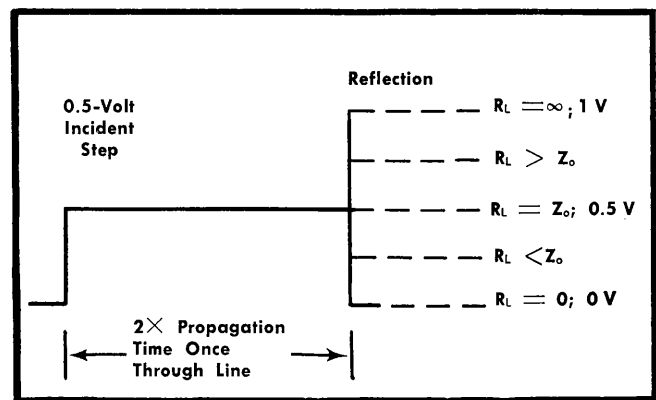

Fig. 2-25. TDR oscilloscope voltmeter displays for circuit of Fig. 2-24, dependent upon value of R_L vs Z_o .

Calibrating the System Rho

Correct setting of the oscilloscope vertical gain permits the TDR reflection displays to be calibrated in rho per vertical division. Two types of vertical units are discussed below for use with a 50 Ω transmission line.

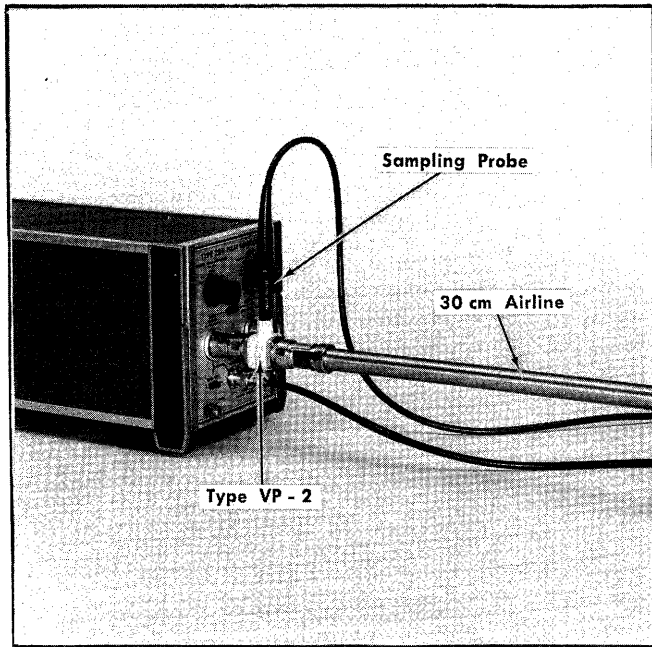

Fig. 2-26. TDR setup for P6038 Sampling Probe.

Using a Sampling Probe Unit. Fig. 2-26 shows the Type 284 pulse output signal applied through a Type VP-2 voltage pickoff unit. The cable under test can be attached to the end of the 50 Ω reference 30 cm airline, or connected directly to the VP-2. As an initial setup example, the 30 cm airline is used and left unterminated.

Insert the P6038 Sampling Probe (from the Type 4S3 or Type 3S3) into the Type VP-2. Set the timing unit for a sweep rate of 1 ns/div, and for external triggering, AC coupled. Connect the Type 284 TRIGGER OUTPUT connector to the timing unit 50 Ω trigger unit connector through a 50 Ω coaxial cable. Set the vertical unit for a deflection factor of 100 mV, and adjust the Variable millivolts/div control for a displayed waveform similar to that of Fig. 2-27.

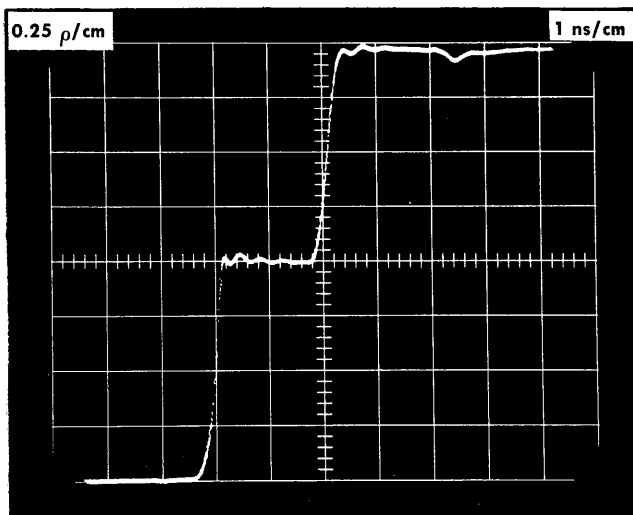

Fig. 2-27. Typical display for calibrating the system ρ .

The first 4 div rise in Fig. 2-27 is the generator step followed by the 2 div flat portion representing the time for the signal to go down and back in the 30 cm airline. The second 4 div rise is a $+1 \rho$ reflection showing that the airline is unterminated. The incident pulse 4 div display of $+1 \rho$ has a deflection factor of $0.25 \rho/\text{div}$ ($1 \rho \div 4 \text{ div} = 0.25 \rho/\text{div}$). To obtain other ρ deflection factors, leave the Variable (millivolts/div) control as set for 4 divisions of incident displayed pulse, and change the sampling unit mV/div switch. Table 2-1 lists various ρ deflection factors obtainable for both a 4 div and a 5 div incident pulse display.

TABLE 2-1

ρ/div Deflection Factors Using VP-2 and a Sampling Probe Unit

Millivolts/div switch ²	ρ/div with 4 cm incident display. (Fig. 2-27)	ρ/div with 5 cm incident display.
100	0.25	0.2
50	0.125	0.1
20	0.05	0.04
10	0.025	0.02
5	0.125	0.01
2	0.005	0.004

²After Variable control is properly set.

If a line is terminated in its characteristic impedance no reflection can be observed, and the line end cannot be determined from the display. One procedure to locate the end of a terminated line is to make a small change in the termination and thus cause a reflection. As an example, the 50 Ω termination on a 30 cm airline was not inserted fully onto the airline. This incorrect mating caused a small reflection which is displayed in Fig. 2-28A. Fig. 2-28B shows increased vertical deflection of the oscilloscope making the end-line fault more obvious and thus easy to find.

Using a 50 Ω Power Divider. Calibrating a 50 Ω power divider TDR system is different than the Probe system described above. The fully 50 Ω sampling system requires an attenuator coupling device, such as the GR 874-TPD shown in Fig. 2-29. The signal losses in the power divider must be considered when adjusting the oscilloscope vertical deflection sensitivity to obtain a calibrated ρ/div deflection factor. The setup for this calibration is shown in Fig. 2-29. The power divider matches the Type 284 50 Ω output to both the oscilloscope 50 Ω input and the 50 Ω transmission line under test. The loss between any two of the power divider connectors is 6 dB (half voltage) when each connector has a 50 Ω circuit connected.

Set the timing unit for 1 ns/div, externally triggered from the Type 284. Set the oscilloscope vertical mVolts/div switch to 50 and adjust the Variable mVolts/div control somewhat clockwise to obtain a display amplitude like that of Fig. 2-30. The display has an incident signal amplitude of 4 divisions. This represents the same amplitude as the signal being fed to the 30 cm airline. However, the amplitude of any reflection is reduced one half by the power divider. Fig. 2-30 shows the open line reflection as $1/2$ the incident amplitude. Thus the reflection signal ρ/div is 0.5 (instead of 0.25 for the incident signal). Other mVolts/div switch settings are now calibrated in ρ/div as shown in Table 2-2.

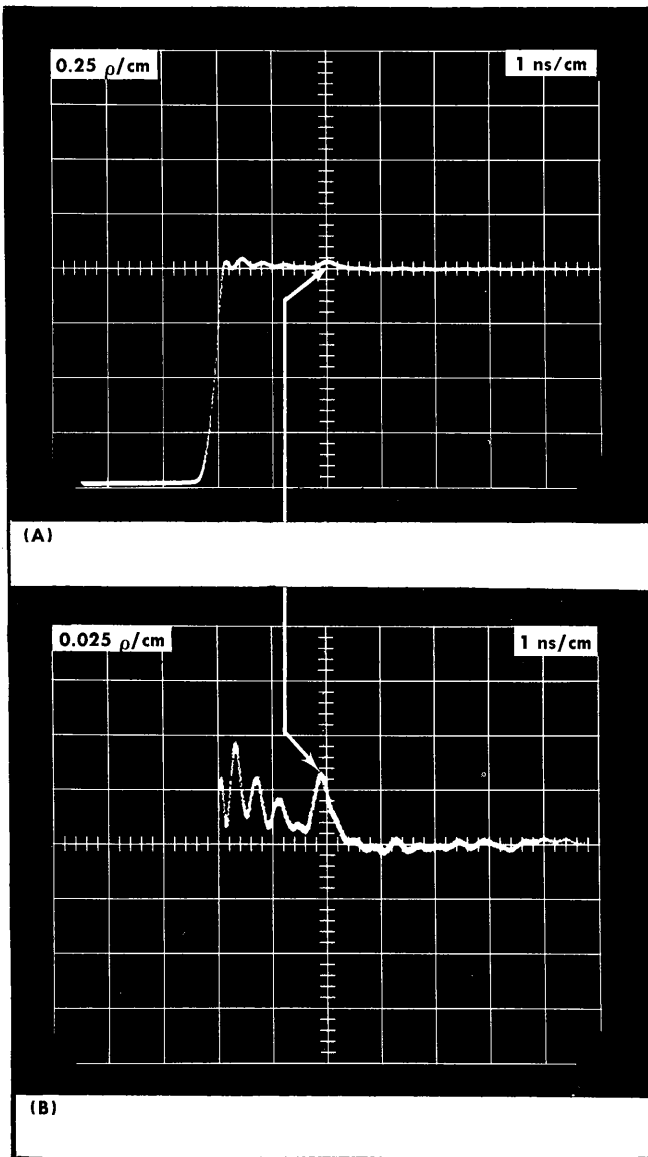

Fig. 2-28. Reflections from incorrectly installed termination.

TABLE 2-2

50 Ω Power Divider Reflected Signal ρ

mVolts/div switch ³	ρ/div with 4 Div Incident deflection. (see Fig. 2-30)	ρ/div with 2 Div Incident deflection.
100	1.0	2.0
50	0.5	1.0
20	0.2	0.4
10	0.1	0.2
5	0.05	0.1
2	0.02	0.04

³After Variable control is properly set.

Finding R_L From ρ

If ρ is known, R_L can be found by rearranging formula (4);

$$R_L = Z_o \left(\frac{1 + \rho}{1 - \rho} \right) \quad (5)$$

Formula (5) applies to any display that results from a purely resistive load. The load is assumed to be at the end of a lossless coaxial transmission line.

Substituting 50 Ω for Z_o in formula (5), calculations for small values of ρ show that each division of reflected signal is approximately equal to a certain number of ohms. Table 2-3 lists the ohms per division for vertical deflection factors of 0.005 ρ, 0.01 ρ and 0.02 ρ. Or, for R_L values near 50 Ω, you may use the approximation formula:

$$R_L \approx 50 + 100 \rho$$

This approximation formula has an error of ≤ 2.2% for absolute values of ρ ≤ 0.1 and an error of ≤ 8% for absolute values of ρ ≤ 0.2.

R_L for reflections with ρ up to essentially +1 or -1 can be quickly determined using the graph of Fig. 2-31. Fig. 2-31 is based upon a transmission line characteristic impedance of 50 Ω just prior to the discontinuity that causes the reflection signal. The graph of Fig. 2-31 may be photographically reproduced without special permission of Tektronix.

TABLE 2-3

R_L Approximations For Reflection Coefficients of 0.005, 0.01 and 0.02 Related to a 50 Ω Transmission Line

ρ/div	Ω/div	Error/div
0.005	1/2	~0.016 Ω
0.01	1	~0.066 Ω
0.02	2	~0.2 Ω

Timing

In order to use TDR to measure the physical length of a transmission line, the oscilloscope sweep rate must be adjusted to match the signal velocity of propagation within the line. (Measurement of electrical length can be done using the oscilloscope calibrated sweep rates directly.)

The velocity of signal propagation in an air dielectric transmission line is 30 cm (one way) in 1 ns, or round trip in 2 ns. Solid, or semi-solid dielectric lines have propagation velocities slower than that of air. Table 2-4 lists three

TABLE 2-4

Coaxial Transmission Line Signal Velocity of Propagation (V_p) Compared to the Speed of Light (c)

Transmission Line Dielectric	V _p
Air	1.0 × c = 30 cm/ns ⁴
TFE ⁵	0.695 × c = 20.85 cm/ns
Polyethylene ⁵	0.659 × c = 19.77 cm/ns

⁴cm × 0.3937 = inches.

⁵Solid (not foamed) dielectric material.

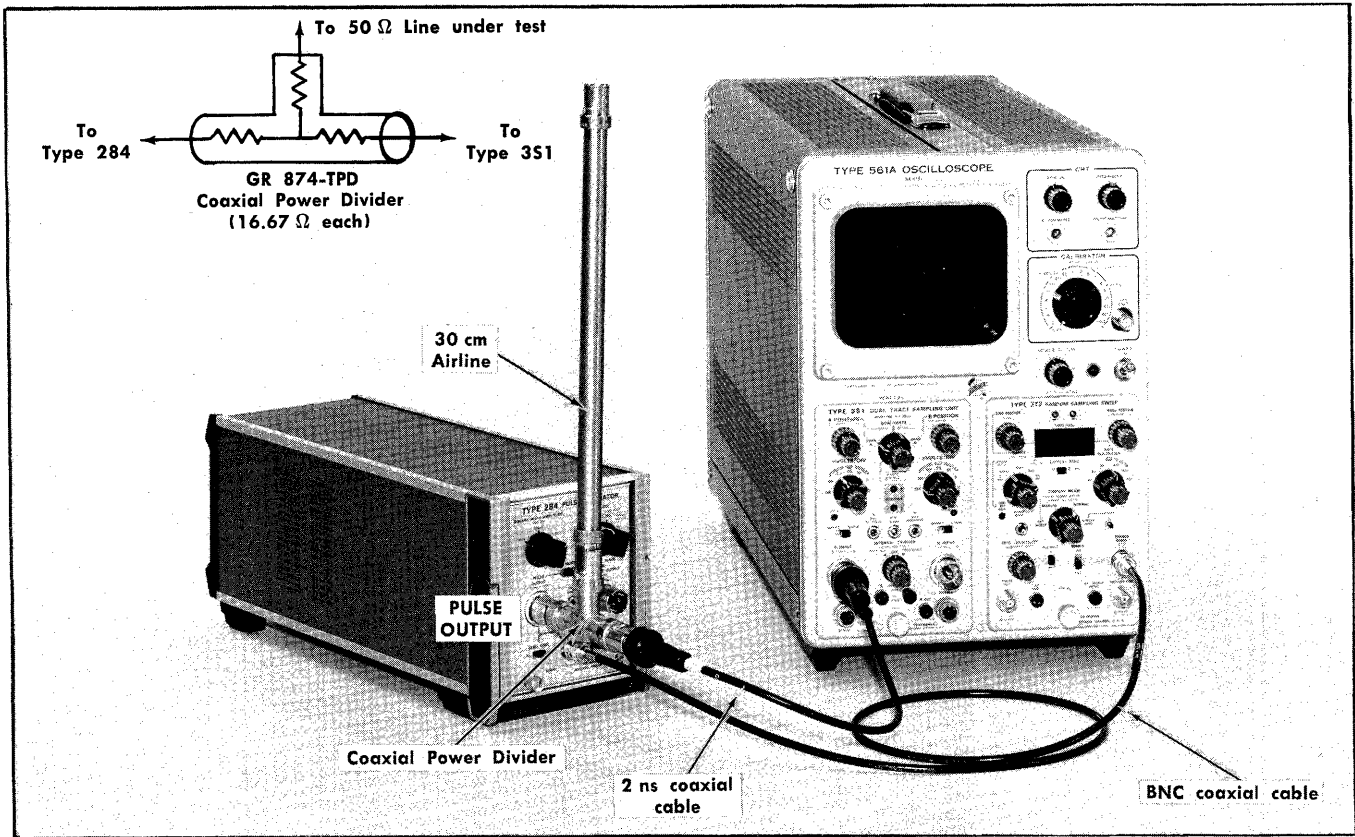

Fig. 2-29. TDR setup for 50 Ω Input Sampling oscilloscope.

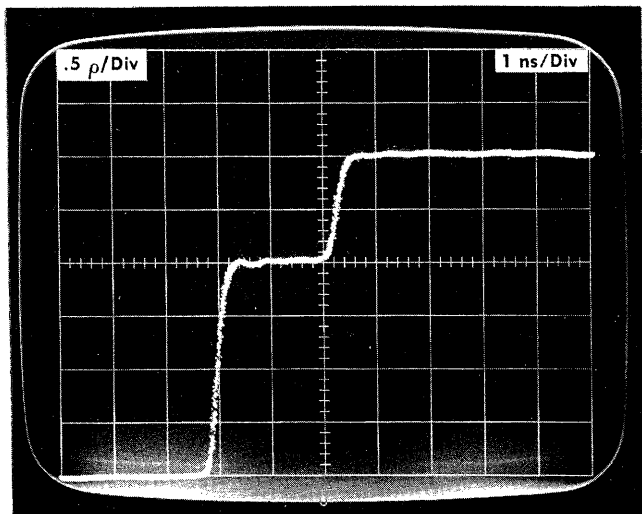

Fig. 2-30. Display for calibrating a 50 Ω system reflected signal reflection coefficient when using a GR power divider.

common velocities of signal propagation in transmission lines. Even though the figures are given to the 3rd place after the decimal, variations in manufacture may create variations of the individual cable signal velocity.

Table 2-5 lists special horizontal sweep rates in units of meters per division for the special case where the sweep rate

variable control is adjusted to display a transmission line length of one meter in ten divisions. The initial system includes a 30 cm airline on the test side of either the VP-2 or the Power Divider (as shown in Fig. 2-26 or Fig. 2-29). The 30 cm airline gives a "clean" time reference for the positioning of the oscilloscope display at the CRT graticule left edge.

TABLE 2-5

Special Distance Sweep Rates when Sweep is Calibrated to Display One Meter in 10 Div

Time/Div Switch ⁶	Distance/Div
.2 ns	1 cm
1 ns	5 cm
2 ns	10 cm
10 ns	0.5 meter
20 ns	1 meter
.1 μs	5 meters
.2 μs	10 meters
1 μs	50 meters

⁶Calibrated with Variable control as above at 2 ns.

Procedure

Connect a GR 874-WN short circuit termination to the 30 cm airline end. Set the oscilloscope vertical for a deflec-

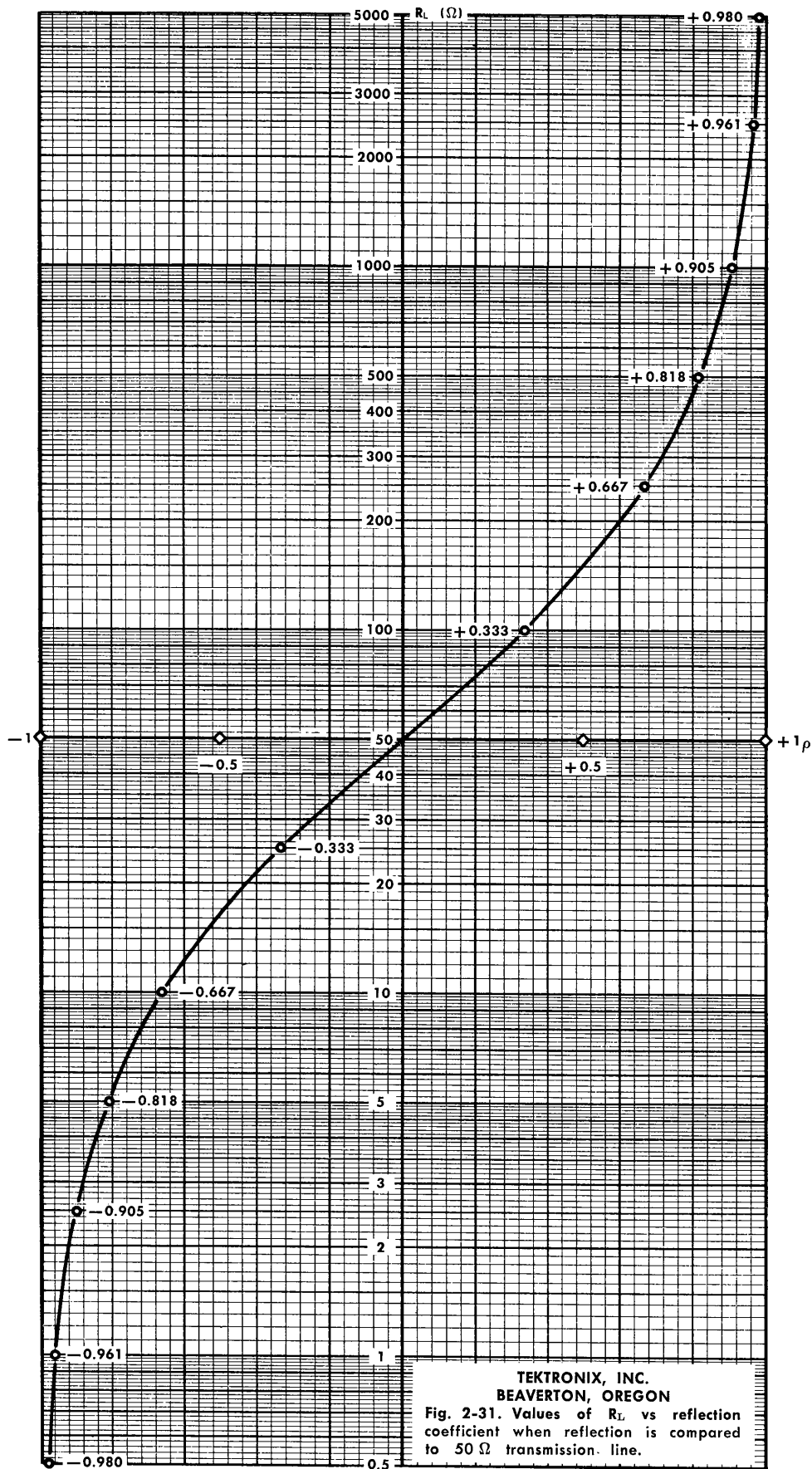

TEKTRONIX, INC.
BEAVERTON, OREGON
Fig. 2-31. Values of R_L vs reflection coefficient when reflection is compared to 50Ω transmission line.

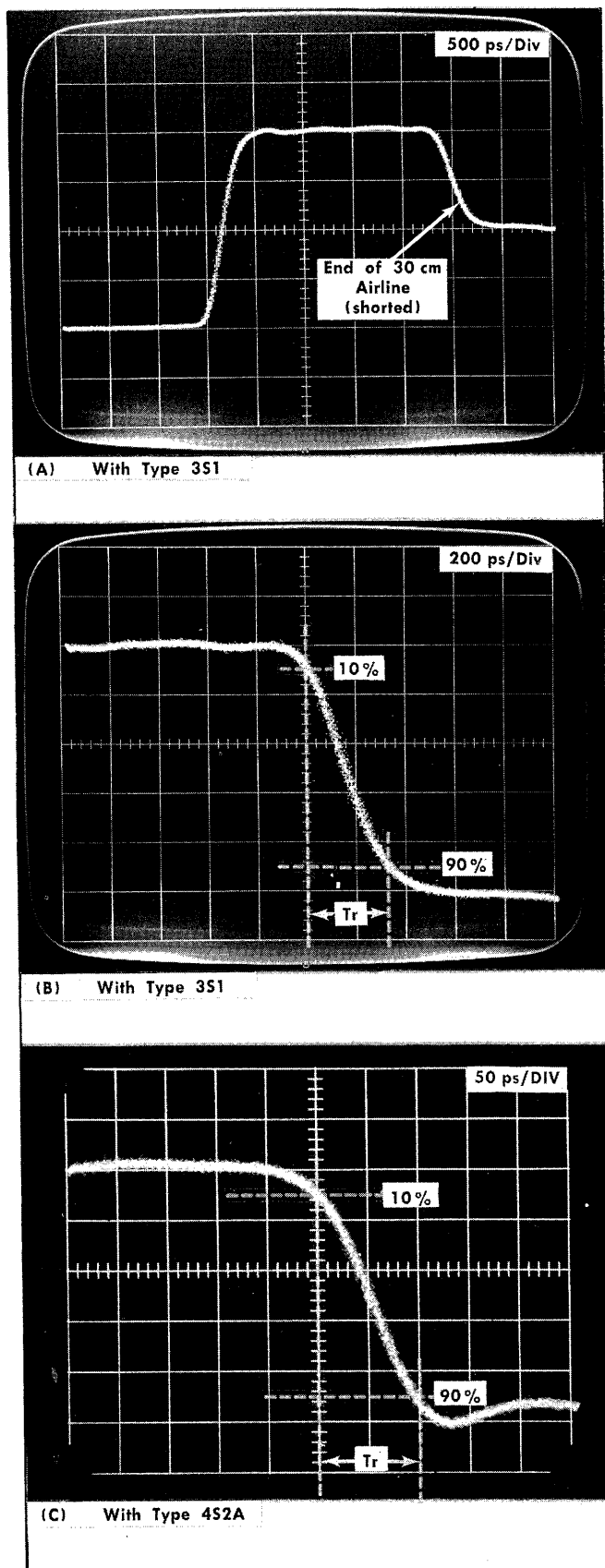

Fig. 2-32. Typical displays showing method of checking system risetime.

tion factor of $0.5 \rho/\text{div}$, and the horizontal time/div control to 2 ns. Obtain a display of the short circuit, and position the negative step to the graticule left edge. Remove the short circuit and install the one-meter length of test cable to the 30 cm airline. Install the short at the one-meter cable outer end. Adjust the timing unit Variable control to speed up the sweep rate so the short circuit display falls at the graticule right edge.

Changing the timing unit Variable control may move the 30 cm airline short circuit display position. Thus it is necessary to repeat the above procedure two or three times to be certain that the graticule ten divisions truly represents one meter of transmission line. Now refer to Table 2-5 for other sweep rates for other positions of the time/div switch.

NOTE

The Type 284 output pulse minimum time duration of $1 \mu\text{s}$ provides a maximum cable length observation of about 150 meters of airline and about 100 meters of solid Polyethylene dielectric line.

Special TDR Applications

Many special measurements are possible with a fast-rise TDR system. Several of these types of applications are discussed in detail in an article on TDR published in the August 1967 Tektronix Service Scope. That article related specifically to use of the Tektronix Type 1S2 Sampling Unit. However, the Type 284 Pulse Generator provides an output pulse that is fast enough to permit it to be used for fast-rise measurements discussed for the Type 1S2.

A fast-rise TDR system that includes the Type 284 as the pulse source must use an oscilloscope with a vertical risetime in the order of 70 to 100 ps. Such a system will include the Tektronix Type 4S2A, Type 5T3 and Type 661.

Lower rate-of-rise measurements that include the testing of long (or lossy) transmission lines are also possible using the Type 284 as the pulse source. This TDR system can use an oscilloscope with a vertical risetime of 350 ps. Such a system will include the Tektronix Type 3S1 (or Type 3S76), Type 3T2 (or Type 3T77A) and a 560-series Oscilloscope.

No attempt is made here to present the application discussed in the TDR article mentioned above. However, if the TDR system uses the Type 284 and a power divider, the measurement of system risetime required for some measurements is different than discussed in the article and therefore presented here.

Checking the TDR System Risetime Using the Type 284 and A Power Divider

Fig. 2-32 shows three TDR oscilloscope displays that were made to measure the risetime of a system using a Power Divider. Fig. 2-32A shows the general type of display when measurements are made at the end of a 30 cm airline. The airline was short circuited by a GR 874-WN Short Circuit Termination.

Fig. 2-32B and Fig. 2-32C are examples of expanded vertical and horizontal deflection factors that permit the reflected signal (thus the system) risetime to be measured. The short circuit is used when testing system risetime to obtain

Operating Instructions—Type 284

a more accurate reading than can be obtained by an open circuit. (Energy is radiated from an open circuit, causing an error in reflected signal risetime if the system has a risetime in the order of 100 ps or less.) Fig. 2-32B is the display used to check the risetime of a "fairly slow" system, in the order of 350 ps. Fig. 2-32C is the display from a fast system whose vertical unit has a risetime of 90 ps. Responses must

be considered as part of the system and any fast risetime measurements are thus made from the 50 Ω point to the first negative peak at the 0 Ω point.

Once the system risetime is known (with whatever length and type of coaxial line used between the Power Divider and the test point) then accurate TDR measurements listed in the Service Scope article can be performed.

SECTION 3

CIRCUIT DESCRIPTION

Change information, if any, affecting this section will be found at the rear of the manual.

General

The Type 284 Pulse Generator circuits provide three types of output signals. A fast pulse, with risetime and transient response specified; a square wave with amplitude and pulse period specified; and a sine wave with the period specified. Each signal source uses a common trigger signal output terminal for externally triggering the oscilloscope time base generator.

BLOCK DIAGRAM

The Block Diagram is located with the schematics at the back of this manual. It includes all circuits except the power supply, with circuit names the same as identified on the schematic diagrams. Each active component, connector, test point and control is identified. The instrument is divided into two major sections, with the MODE switch used to select which circuits operate. The block diagram is drawn, the MODE switch applies power to the Square Wave or Sine Wave circuits, and the PERIOD switch selects the 10 μ s output signal.

Square Wave or Sine Wave Blocks

The Low Frequency Oscillators Q1, Q10 and Q20 are individually turned on by the PERIOD switch. All three output circuits remain connected to the Emitter Follower (buffer) Q30. Q30 drives the Squarer block, that delivers both the amplitude controlled square waves to the Attenuator and the trigger signal to the Trigger Isolation block. The square wave amplitude is adjusted by the Amplitude control through the Emitter Follower Q50.

The High Frequency Oscillators, Q60 and Q70 are also individually turned on by the PERIOD switch. Their output circuits include a resistive matrix which allows each oscillator output to remain connected to the Trigger Isolation and Sine Wave Amplifier circuits at all times. The Trigger Isolation block, and the pulser Trigger Generator block both drive the front panel TRIGGER OUTPUT connector.

The Sine Wave Amplifier provides isolation between the two High Frequency Oscillators and any changes in load at the front panel SQUARE WAVE OR SINE WAVE OUTPUT connector.

Pulser Blocks

The Tunnel Diode Pulser circuits are energized when the MODE switch is placed toward the PULSE OUTPUT connector. The 50 kHz repetition rate is set by the Oscillator & Multi block, which shapes the oscillator waveform to properly drive the TD Bias Driver circuits. Two halves of

the TD Bias Driver provide both the proper arming bias to the TD Pulser, and a drive pulse to the Trigger Generator. Once, during each half cycle of the oscillator signal, the TD Bias Driver arms the TD Pulser, then the TD Tripper triggers the pulser to deliver a signal to the PULSE OUTPUT connector. About 1 μ s later, the TD Bias Driver removes the arming bias from the TD Pulser and returns the pulse output to zero.

The Trigger Generator drives both the TD Tripper block and the front panel TRIGGER OUTPUT connector. The LEAD TIME switch allows the operator to additionally delay the TD Pulser firing time by inserting a signal delay between the Trigger Generator and the TD Tripper block.

The TD Tripper applies a fast trigger pulse to the TD Pulser to drive the TD, which then delivers a fast step pulse to the PULSE OUTPUT connector.

PERIOD GENERATORS AND SWITCHING

See the schematic diagrams for waveforms that relate to the following descriptions.

Low Frequency Oscillators

Two of the three Low Frequency Oscillators, Q1 and Q10 are Colpitts oscillators, operating at a 10 μ s period (100 kHz) and a 1 μ s period (1 MHz) respectively. The third oscillator, Q20, is a crystal controlled Pierce oscillator, operating at a 100 ns period (10 MHz). Each oscillator tank circuit operates at DC ground potential, allowing all three oscillators to drive a common resistance matrix and emitter follower buffer stage.

Circuits of the 10 μ s and 1 μ s oscillators are identical except for component values. The basic oscillator circuit is redrawn in Fig. 3-1, showing how the power supply bypass capacitor C38 connects the transistor collector to the ground end of the parallel resonant tank circuit. Fig. 3-1 shows that the transistor collector and base signal voltages are caused by the resonant circuit to be 180° different. The 100 Ω current limiting resistor is left out of Fig. 3-1 to emphasize that it plays no part in the oscillator action. (R1 and R11 serve only to limit +20-Volt power supply current in case the transistor develops a base-to-collector short circuit.) Energy to keep the tank circuit RF current as a steady RMS value is supplied through R4 (and R14) to the half-voltage point between the two equal tank capacitors.

Transistor current flows approximately one half of each cycle. As Q1 conducts, positive feedback current (of about 15 mA) is supplied to the resonant circuit through R4. While Q1 current is cut off, the emitter return resistor (R5) applies about 6.3 mA of negative current to the resonant

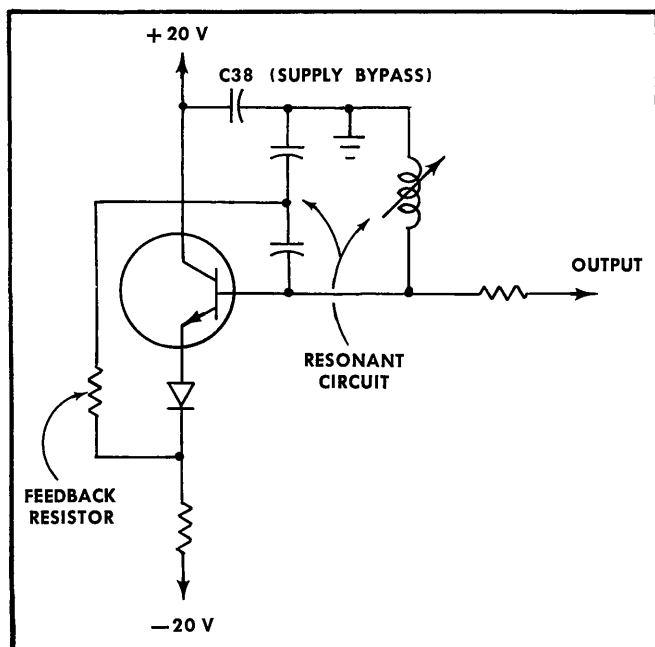

Fig. 3-1. Low frequency oscillator.

circuit. Thus current through the feedback resistor R4 (and R14) reverses duration each half cycle.

Peak-to-peak output voltage swing is approximately 20 volts. D5 (and D15) protect the base-emitter junction from reverse voltage breakdown during the half cycle that the transistor does not conduct.

The 100 ns oscillator is a crystal-controlled Pierce oscillator. The frequency of oscillation is just a little above the crystal series resonant frequency. The resonant circuit in the collector lead is at DC ground, and the oscillator is powered from the -20-Volt supply only. The base circuit quiescent voltage is about -9 volts, set by the divider R23-R24. The emitter return circuit is bypassed to ground by C25. D25 protects the transistor base-emitter junction from reverse voltage breakdown during the part of each cycle that the transistor does not conduct. The capacitor (C22) between Q20 collector and base applies some of the collector signal to the base. The signal current through C22 causes the collector signal to be more than 180° different than the base signal. C22 value sets Q20 base to collector signal phase relation to a point that causes the crystal to oscillate closer than normal to its series resonant frequency.

Output coupling of each of the three oscillators is through a series resistor to the base lead of Q30. Since only one oscillator functions at a time, the series output resistors of the two inactive oscillators are part of the resistive load of the active oscillator.

Duty Factor Control

Part of the resistive load for the Low Frequency Oscillators is the Duty Factor control R31 and R32 in series to the +20-Volt supply. R31-R32 offset the zero reference oscillator output signal(s) to a positive value centered on approximately 2 volts. The 2-volt value is required by the Squarer circuit and its emitter follower input. Adjustment of the Duty

Factor control is made after the output amplitude is adjusted, centering the oscillator drive signal voltage on the required value to produce a symmetrical output square wave.

Squarer

The Squarer circuit is a current switching amplifier that is overdriven by the Low Frequency Oscillators. Q35 base receives the sine wave input and Q55 base receives a steady DC input. As Q35 base is driven more positive than Q55 base, all the current is switched to Q55. D35 limits the positive voltage swing at Q35 base. This keeps Q35 base-emitter electrostatic potential difference near zero so that as the drive signal goes negative Q35 turns on rapidly. As Q30 drives Q35 base more negative than Q55 base, all of the current is switched to Q35.

The current magnitude in Q55 is adjustable by use of the AMPLITUDE control. Altering the AMPLITUDE control alters the DC voltage at Q55 base. When Q55 is conducting, it does not saturate. The output voltage at Q55 collector is set precisely by Ohms law (25 Ω and the fixed collector current). The collector current is set precisely to 40 mA by R38-R39 and the voltage difference between Q55 emitter and the +20-Volt supply (emitter current, minus base current, equals 40 mA). The steady 40 mA collector current is temperature-compensated by the series PN to NP base-emitter junctions of Q50 and Q55. As the temperature increases, both transistors, base-emitter voltages decrease. The two temperature sensitive actions assure that Q55 emitter voltage remains fixed over a wide temperature range. Q55 steady 40 mA collector current sets a steady voltage drop across the collector load resistance.

The external load resistance placed upon the SQUARE WAVE OR SINE WAVE OUTPUT connector affects the output voltage amplitude. The SQUARE WAVE AMPLITUDE switch voltage values are valid only when the external load is 50 Ω. The output voltage doubles when there is no external load.

Negative drive from Q30 to Q35 base turns Q55 off and turns Q35 on. Q35 collector current is nearly the same as that when Q55 was conducting. The current develops about +0.2-volt across R40 to drive the Trigger Isolation amplifier Q40.

Trigger Isolation amplifier Q40 amplifies and inverts the signal developed across R40. The stage gain is greater than required, and R46-R48 attenuate the signal to the correct amount. The large value of R44 does not load the sine wave trigger signal from Q80. Q40 DC current is set by R42 in its emitter circuit. C42 bypasses R42, assuring adequate stage gain. C44 is a DC blocking capacitor at Q40 collector to AC-couple the trigger signal output.

Two components not mentioned above are R35 and C56. R35 limits the signal drive current to Q35 base and limits the current through D35 into C56. C56 is used for its charge storage, holding Q55 base voltage essentially constant against Q55 base current changes and R35-D35 current.

Switching

Three switches combine to determine the output signal and its amplitude. The switches are the center-panel MODE

switch, the SQUARE WAVE AMPLITUDE and the PERIOD switches.

The MODE switch applies both the +20- and -20-Volt power supplies to the proper circuits. When the MODE switch is placed toward the SQUARE WAVE OR SINE WAVE OUTPUT connector, the low frequency or high frequency oscillators can function. Selection of the oscillators is done by the PERIOD switch; only one oscillator operates for each switch position.

When the PERIOD switch is placed to either of the 10 μ s, 1 μ s or 100 ns positions, the output signal is a square wave. (The switch also determines which of the three low frequency oscillators is energized.)

When the PERIOD switch is at either 10 ns or 1 ns, one of the High Frequency Oscillators is energized and the SQUARE WAVE OR SINE WAVE output connector is driven by the Sine Wave Amp Q90. The SQUARE WAVE AMPLITUDE switch does not function while the 10 ns or 1 ns signals are being used.

High Frequency Oscillators

Q60 is the active element of the 10 ns oscillator, and Q70 is the active element of the 1 ns oscillator. Both oscillators use inductors that are part of the etched circuit board. The 10 ns oscillator inductor is one turn. The 1 ns oscillator inductor is in the form of a resonant transmission line. Each output coupling is also part of the circuit board.

Output of the two oscillators is resistance-matrix coupled to two common base amplifiers. Q80 drives the front panel TRIGGER connector, and Q90 drives the PERIOD switch and the SQUARE WAVE OR SINE WAVE OUTPUT connector. The PERIOD switch selects which oscillator is energized from the -20-volt supply.

The two common base stages both remain in operation for either High Frequency oscillator. Their operation is assured by power switching diodes D84 and D94. If the PERIOD switch is at 10 ns, D84 is reverse biased to prevent turning Q70 on, and D94 conducts. If the PERIOD switch is at 1 ns, D84 conducts and D94 is reverse biased to prevent turning Q60 on.

10 ns Oscillator. Q60 and its associated components form a Colpitts oscillator. The operating frequency is determined by T65 and C61-C62-C63. C62 allows the frequency to be adjusted during calibration. C65 is a large value and therefore only a DC blocking capacitor. Output coupling is accomplished by an inductively coupled secondary, part of the etched circuit board. C66-L66 are series resonant to couple maximum RF current into Q80 and Q90 through R85 and R95.

Oscillator feedback is applied through R62 to the half voltage point of the resonant circuit.

The resonant circuit connections assure that the collector and base signals are 180° different. L61 is a low resistance DC path for Q60 collector current while isolating the signal voltages at the collector from ground.

Feedback current through R62 is identical to feedback current described for the low frequency oscillators. While the transistor is conducting, Q60 emitter applies energy to

the tank circuit. While the transistor is not conducting, the resonant circuit receives opposite polarity energy from the -20-Volt supply through R63 and R62.

1 ns Oscillator. Q70 and its associated components form a resonant transmission line oscillator. The frequency is determined by a half wave line, plated as part of the etched circuit board, whose electrical length is made adjustable by C73. Fig. 3-2 shows the oscillator redrawn slightly different from the main diagram, highlighting the half-wave resonant line and the feedback path.

The positive feedback capacitor, C74, couples some of the transistor collector signal voltage to the emitter, driving the emitter-base junction. The signal fed to the emitter, in phase with the collector signal, is similar to driving the base with a signal shifted 180° in phase. R71 and R75 provide AC isolation of the power supply lead.

Fig. 3-2 shows the transistor internal collector to base capacitance, C_{OB} . C_{OB} is also a signal path from collector to base, but it is a capacitance that would provide negative feedback if the base lead were not grounded. Thus the grounded base circuit cancels the negative feedback effects of C_{OB} , and the transistor oscillations are easily maintained by C74. (C74 is part of the etched circuit board, and is not replaceable as an individual component.)

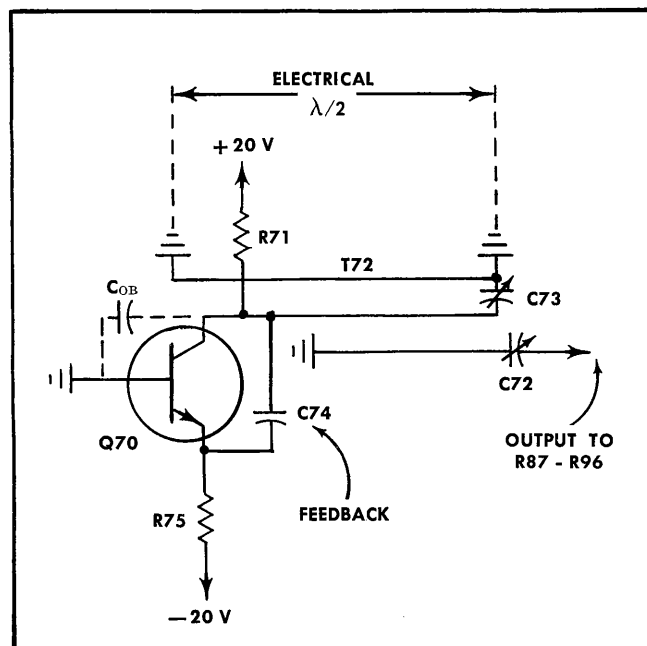

Fig. 3-2. 1 ns oscillator circuit.

Output coupling from the resonant transmission line is also part of the etched circuit board, located on the bottom side away from normal view. It is also a transmission line. C72 and the coupling line are series resonant at 1 GHz to provide low impedance current drive to R87 and R96.

Trigger Isolation and Sine Wave Amplifier

Both High Frequency oscillators drive both the Trigger Isolation amplifier Q80 and the Sine Wave amplifier Q90.

Circuit Description—Type 284

Each amplifier is a common base circuit with resistance-capacitance coupling to the output circuit. Each amplifier is current driven from the active High Frequency oscillator through isolation resistors. The resistors not only isolate the unused High Frequency oscillator from the active oscillator, but also set the signal current magnitude to the two common base amplifiers and thus the output signal amplitude.

The sine wave Trigger Isolation amplifier (Q80) collector circuit drives the trigger output circuit. C81 couples the signal to J45. The Sine Wave amplifier collector circuit drives the front panel SQUARE WAVE OR SINE WAVE OUTPUT connector through J95 and the PERIOD switch. The trigger isolation amplifier output impedance is set by R48 in parallel with the collector load resistors of both Q40 and Q80.

The square wave Trigger Isolation amplifier (Q40) drives a square wave signal to J45 through C44 and R46. The sine wave trigger isolation amplifier (Q80) collector circuit does not significantly load the square wave trigger signal.

50 Ω Attenuator

Three positions of the PERIOD switch select the square wave output from the Squarer circuit. In series with those three outputs are the 50 Ω attenuators that are controlled by the SQUARE WAVE AMPLITUDE switch. One 50 Ω 10 \times attenuator is used when the SQUARE WAVE AMPLITUDE switch is at 100 mV, and two 50 Ω 10 \times attenuators are used (in series) when the switch is at 10 mV. Use of the two attenuators keeps the output impedance 50 Ω for all three positions of the SQUARE WAVE AMPLITUDE switch.

PULSE GENERATOR

General

The Pulse Generator circuits are driven by a 50 kHz free-running oscillator-multivibrator. The multivibrator signal is converted to a balanced (push-pull) arming drive to the tunnel diode pulser. Part of the TD drive signal is also used to drive an avalanche type Trigger Generator. The Trigger Generator output is used for both the front panel TRIGGER OUTPUT connector signal and to drive a TD Tripper circuit.

TD Pulser

The Tunnel Diode pulser is described first to show the related functions of the TD Bias Driver and the TD Tripper circuits.

Tunnel Diode D180 is the Type 284 pulse source. The diode is located in series with the center conductor of a high quality 50 Ω air dielectric coaxial transmission line. A TD Bias Driver circuit applies arming bias to D180, placing the diode conduction near its current peak at the low voltage state. Approximately $\frac{1}{2}$ μ s later, the TD Tripper applies fast push-pull pulses which drive the TD to its high voltage state. The TD voltage step travels away from the diode in both directions, the positive half toward the front panel PULSE OUTPUT connector, and the negative half toward the termination that consists primarily of R184A, paralleled by R184B, R184C and R148 all in series. The reverse termination (R184A, etc.) absorbs essentially all of the pulse energy

it receives so that very little is reflected back to the front panel connector.

Approximately one μ s after the TD trips to its high voltage state, the TD Bias Driver drops its current drive and the TD returns to its low voltage - low current state.

The TD arming bias is applied from two low impedance voltage sources (Q135 positive, Q145 negative) whose peak amplitudes are adjusted so that D180 anode rests at zero volts to ground before it is triggered to its high voltage state. The arming bias voltage amplitude is made adjustable by the front panel TD BIAS screwdriver control. Adjusting the bias voltage amplitude adjusts the TD current. Peak bias voltage drive (applied between J180 and J184) is about 30 volts peak to peak, which is converted to about 21 mA by the series resistance of R180, D180, R184B and R184C. When externally loaded, there is 50 Ω to ground at each side of D180. The current is adjusted to slightly less than the peak value of the particular tunnel diode installed as D180.

Tunnel diode tripping drive current is capacitively coupled to the tunnel diode through two very small capacitors, C185 and C186. The very fast push-pull step signal from the TD Tripper circuit drives enough current into D180 through the two small capacitors to exceed the diode peak current value. The diode then switches to its high voltage state and sends the fast rise pulse to the PULSE OUTPUT connector.

Type 284 circuit provides two types of tunnel diode drive: 1) slow-rising flat-topped arming pulse, and 2) a fast current pulse. The two drive signals produce a clean tunnel diode step with no slope of the output voltage for about 1 μ s prior to the step. It is this type of two-stage drive that permits a clean step signal without any drive signal being included in the step.

There is a possibility that some of the TD Bias arming signal can appear about 1.4 or 1.5 μ s in advance of the fast pulse. When it occurs, it is caused by high frequency differences in the transistors of the TD Bias Driver circuit. A few units tested showed the output of from zero to 90 mV. This is considered normal, and not a problem worthy of maintenance or correction.

50 kHz Oscillator-Multi

Q100 is the 50 kHz oscillator, and Q110-Q111 form the one-shot multivibrator. The oscillator is a Colpitts type, with Q100 base at DC ground. Feedback energy is applied to the resonant circuit during transistor conduction at the junction of two dissimilar capacitors, C101-C102. Energy of the opposite polarity is applied to the resonant circuit by R103 and the +20-Volt supply when the transistor is not conducting.

C102 (part of the resonant circuit) is loaded by diode conduction each half cycle. When Q100 base goes positive, D102 conducts as the voltage across it reaches 0.6 to 0.8 volt. When Q100 base goes negative, the base-emitter diode conducts as the voltage across it reaches 0.6 to 0.8 volt, causing the transistor to saturate. D102 conduction assures that Q100 base-emitter junction is not reverse biased very much each half cycle, which keeps the transistor ready to conduct at the instant the tank circuit applies forward bias.

Since Q100 saturates and cuts off each half cycle, the collector voltage signal changes from -20 volts to $+0.4$ volt and back to -20 volts. The positive-going part of the collector signal is coupled through C105 to the base of Q110. C105 conducts current into Q110 base-emitter junction and is thereby discharged. The negative-going part of the collector signal recharges C105 by conduction through D105.

Quiescent conditions of the one-shot multi are:

1. Q111 is saturated by turn-on current through R115.
2. Q110 is cut off because Q111 collector voltage is at $+0.1$ volt, not positive enough to forward bias Q110 through R112.
3. Q110 collector voltage is held at $+0.93$ volt by Q120 base current.

The operational sequence starts as the oscillator transistor conducts. Q100 fast positive collector signal applies a quick turn on to Q110 base through C105. Q110 saturates and applies a negative 0.9 -volt signal to Q111 base. Q111 turns off and R111-R112 hold Q110 in conduction. About $2 \mu\text{s}$ later, R115 has charged C115 sufficiently to take Q111 base positive far enough so that Q111 conducts. As Q111 conducts, drive to Q110 is stopped and it cuts off. Later, Q100 cuts off and R105 recharges C105. C105 charge current path includes D105, which prevents Q110 base from going more negative than about -0.8 volt. The multi remains with Q110 off, and Q111 on, until the oscillator transistor again conducts.

TD Bias Driver

The TD Bias Driver circuits convert the Oscillator-Multi output signal to a push-pull low impedance voltage drive to the TD Pulser. Q120-Q125 form a switching amplifier that is normally saturated in both halves. When Q110 (of the multi) is at cutoff, its collector resistor R117 conducts 1 mA through the three diode junctions of Q120 base-emitter, Q125 emitter-base and D127 cathode to anode to ground. Q120 and Q125 are saturated at about 9 mA collector current each. A very small part of R117 current passes in R125, but R125 serves no useful purpose as long as Q120 and Q125 are saturated.

When Q110 saturates, all of R117 current is taken by Q110 and both Q120 and Q125 are cut off. R125 connection to Q120-Q125 emitter assures that I_{ECO} leakage of either transistor does not cause collector to base current and a resulting distortion of the TD Pulser output voltage. R127-D127 sets Q125 base voltage at -0.6 volt to place Q120 and Q125 $V_{\text{CE-SAT}}$ collector voltages nearly equal. If the two collector voltages are not essentially equal (before being cut off) the two output signals will not rise at equal rates and the TD Pulser resting voltage (right after the pulse ends) will be significantly different than its zero voltage (just before the next pulse).

Q120 and Q125 each drive two cascaded emitter followers. Q120 drives Q130 and Q135, and Q125 drives Q140 and Q145. Amplitude of the voltage drive to Q130 and Q140 is set by the TD Bias including R121-R131-R132-R141 and R129 all in series between the $+20$ - and -20 -Volt power supplies. Balance of the drive signals to ground is adjusted by the Bias Bal circuit including R122-R123 and R124. (The "drive signals" as named here refer to that portion of the TD arming signal caused by cutting off Q120

and Q125. The Bias Bal circuit has no effect upon the balance of the output signals when Q120 and Q125 are saturated.)

Each pair of cascaded emitter followers has three diodes in series between the first transistor emitter and the second transistor base. The three diodes cause the TD bias drive voltages to have a negative temperature coefficient which compensates for the negative temperature coefficient of the pulser tunnel diode, D180. Thus, as D180 peak current decreases with increased temperature, the TD Bias Driver output voltages also decrease. The result is that the tunnel diode biasing current remains just below the peak current even though the peak current value changes with temperature.

Output emitter followers (Q135 and Q145) emitter circuits include components that properly terminate the two interconnecting coaxial cables for the fast signals received back from the pulser when D180 switches. The termination components do not affect the arming bias signals because of the very short time constant of R139-C139 and R149-C149. Q135 and Q145 emitters look inductive for very fast signals, but resistive at about 10Ω each for low frequencies and DC. R139-C139 and R149-C149 compensate for the inductance of the transistors emitters. The four parts of each termination look like 50Ω for signals arriving back from the TD Pulser, and they absorb all such energy rather than let it be reflected back to the pulser and become part of the output signal.

Two components of the TD Bias Driver circuit not mentioned above are C121 and C129. These two capacitors slow the rise rate of the collector signals of Q120 and Q125 to attempt to make the rise rates equal.

Trigger Generator

The Trigger Generator is an avalanche transistor (Q150) that is driven into conduction by a delayed signal from Q145 of the TD Bias Driver. The drive signal is delayed by R151 and C152. The drive circuit performs as follows: 1) When Q145 output is near zero volts, there is no drive to Q150; 2) D152 anode voltage (due to R152 current) holds Q150 base at $+0.45$ volt keeping the transistor cut off; 3) when Q145 output goes negative to help arm the pulser TD, R150 applies a constant current to D150-D151 which sets D151 anode at -1 volt. R151 then charges C152 negatively. When Q150 base reaches -0.2 volt, the transistor goes into avalanche conduction and the collector circuit produces a fast positive output pulse.

Avalanche conduction of Q150 effectively grounds the collector terminal for 20 or 30 ns . Then as the avalanche action ceases, the transistor reduces conduction for about $0.4 \mu\text{s}$ until the base signal (which has continued to charge C152 negatively) reaches the normal turn-on bias for a silicon transistor. The bias then increases conduction in normal transistor action until the TD Bias Driver signal returns to ground. C152 charge is reversed slowly by R152, and Q150 collector voltage slowly returns to -20 volts. Both output circuits of the Trigger Generator differentiate the collector signal of Q150, making use of the avalanche current and not the normal transistor action current. C156-R157 differentiate the signal for the trigger output, and C159-R159 differentiate it for driving the TD Tripper blocking oscillator. (Ringing evident on the waveform at J155 on

Circuit Description—Type 284

the Pulse Generator diagram is caused by the $10\times$ Probe ground clip inductance. The ringing seen by a test oscilloscope at the avalanche output will usually be attributed to the oscilloscope probe grounding lead length.) The trigger output amplitude is attenuated by R156 and the external $50\ \Omega$ load. The TD Tripper drive is so highly differentiated that it is difficult to see with the 85 MHz test oscilloscope used for the diagram waveforms. (A sampling oscilloscope with probe will properly display the signal.) The TD Tripper drive is coupled to T160 through a short length of coaxial cable and the LEAD TIME switch, or through 70 ns (instruments SN B010100 through B020235, delay line was 45 ns) additional signal delay coaxial cable and the LEAD TIME switch. Either way, T160 receives its trigger from a $50\ \Omega$ coaxial line which is reverse terminated by R159 so reflections will not cause multiple blocking oscillator triggers.

TD Tripper

The TD Tripper consists of a blocking oscillator T160, Q160 and Q165, and a snap off diode, D165. The oscillator drives the snap off diode to reverse its conduction that is otherwise maintained by Q170.

Quiescent conditions of the blocking oscillators are: two windings of T160 hold Q160-Q165 base-emitter junctions at zero bias. The transistors do not conduct, causing Q160 emitter to rest at ground and Q165 emitter to rest at +20 volts. As a trigger arrives at T160, both Q160 and Q165 are caused to conduct. Each collector is cross-coupled to the other base, so that a regenerative turn-on occurs and both transistors quickly saturate. Saturation causes Q160-Q165 emitter voltages to become almost equal and C161-C165 each couple a 10 volt signal to the resistor-transformer diode snap-off circuit to reverse the direction of current in D165.

Q170 applies a steady DC current through D165. As the blocking oscillator applies a reverse current to D165, the junction carriers do not immediately clear out of the diode, but there is a short duration, high-amplitude, reverse current. The reverse current stops suddenly when the carriers all clear out of the junction, which gives the diode its name, "snap off". As the carriers suddenly clear out of D165 junction, +3.8 and -3.8 volts is applied push-pull to the $50\ \Omega$ coaxial cables W185 and W186 through C163 and C167. The parts layout around T165, D165, D163 and C167 assures that the very fast voltage step is coupled into W185 and W186 without high frequency loss. The fast rise signals, + in W185 and - in W186, are capacitively coupled to the pulser tunnel diode through environmental capacitors C185 and C186. D180 then switches to its high voltage state as described earlier in the TD Pulser description.

R163 and R167 reverse terminate T165 to minimize ringing when the blocking oscillator applies the reverse current to D165. The system does not ring significantly as D165 stops conducting, because the energy is applied to the two $50\ \Omega$ coaxial cables. Each cable is terminated at the pulser assembly by R185 and R186 to prevent reflections going back to the snap off circuit that would otherwise disturb the pulser output signal fidelity.

Power Supply

The Type 284 power supply will operate over a wide range of power line voltages and frequencies. Line voltages from 90 VAC to 136 VAC, or from 180 VAC to 272 VAC

will operate the instrument properly. Line frequencies from 48 Hz to 440 Hz are permissible. See the operating instructions for the method to be used when changing from one line voltage range to the other. The fuses for both ranges are located at the instrument rear, inside the line voltage range selector cap.

Power for two regulated DC supplies is obtained from power transformer T201 by two full-wave rectifier systems. The +20-Volt supply receives its unregulated DC from transformer terminals 8, 9 and 10, rectifiers D210-D212, and filter capacitor C210. The -20-Volt supply receives its unregulated DC from transformer terminals 5, 6 and 7, rectifiers D240-D242, and filter capacitor C240. Both power transformer tapped secondaries have equal open circuit voltages, but the operating voltages are different due to different power supply loads. The unregulated DC voltages indicated on the Power Supply schematic diagrams were obtained with the power line voltage at 115 VAC.

The two supplies are similar in operation. Each has a two transistor comparator that compares the output voltage with a stable reference voltage. The comparator drives an amplifier stage that drives the series-pass regulator output stage. Reference for the +20-Volt supply is Zener diode D220, in the +20-Volt supply. The +20-Volt supply then serves as the reference voltage for the -20-Volt supply.

Each supply contains a short-circuit current limiting resistor (R210-R240) which limits the instantaneous current that can be drawn from the rectifier filter capacitor. These resistors, and the general circuit design, make both regulated supplies short-circuit proof. In the event of supply overload or short, the main power can be applied without damaging the instrument.

+20-Volt Regulator. The +20-Volt regulator consists of Comparator Amplifier Q220A-Q220B, Buffer Amplifier Q230, and Series-Pass amplifier Q235. The regulator action consists of changing the collector current of Q235 so the voltage across Q235 emitter to collector changes whenever the rectifier output voltage or the load current changes. Q235 emitter then moves the whole supply to keep the output to +20 volts.

Regulator action is obtained by D220-R222 holding Q220A base a fixed number of volts negative from the +20-Volt output lead. Q220B base voltage is very near to that of Q220A base voltage, but it is not firmly related to the output lead voltage. If the output voltage changes, Q220A base voltage changes the same amount, but Q220B base voltage changes only about $\frac{1}{2}$ as much due to R226-R227 and R228. Thus, half of the output change is the amount of correcting signal applied to Q220A and B.

Assume that the output voltage rises positively: Q220A base voltage rises more positive than does Q220B base voltage. Q220B base responds as if it had received a negative turn-on signal which increases its collector current. Q220B collector voltage increases positive, which decreases Q230 collector current. Q230 decreased collector current decreases the drive to Q235, and Q235 emitter goes negative. Since Q235 emitter is tied directly to the minus lead of the rectifier filter, the filter positive terminal also changes negatively until the output voltage is restored to its correct value. C227 stabilizes Q220B against parasitic oscillations. R233 is a current limiter to Q235 base, and R234 shuts Q235 off when drive is reduced.

—20-Volt Regulator. The —20-Volt regulator consists of Comparator Amplifier Q260A-Q260B, Amplifier Q250, and Series Pass amplifier Q245. Q260A base is connected directly to ground so that any change in the output lead voltage does not change the base voltage. Q260B base voltage is near ground due to the equal resistors R264 and R266, between the +20- and —20-Volt output leads. Thus half of the changes that occur on the —20-Volt output lead are the signal applied to the comparator.

Assume the output voltage changes positive. Q260B base responds to half the change as a turn-on signal which increases Q260B current and decreases Q260A. Q260A collector voltage goes positive, and the positive change is applied (with current gain) to Q245 by Q250 emitter follower. The positive signal to Q245 base increases Q245 collector current, making the collector voltage change negatively.

Since Q245 collector lead is tied directly to the positive lead of the rectifier filter, the filter negative lead also changes negatively to correct for the original positive error.

A special resistor diagrammed with the —20-Volt regulator (R245) assures that both supplies begin to function when the AC power is first turned on. Note that the +20-Volt supply is the positive voltage source for the —20-Volt supply, and the —20-Volt supply is the negative source for the +20-Volt supply. Both regulators would remain shut down if R245 did not force the +20-Volt regulated lead to be positive when the power is first turned on. After both supplies begin to operate, R245 conducts in the other direction and serves no full time operating purposes.

The output lead of both regulators is bypassed by an electrolytic capacitor which helps to keep the AC impedance low for high frequency load changes.

SECTION 4

MAINTENANCE

Change information, if any, affecting this section will be found at the rear of the manual.

Introduction

This section of the manual contains maintenance information for use in preventive maintenance, corrective maintenance or troubleshooting of the Type 284.

PREVENTIVE MAINTENANCE

General

Preventive maintenance consists of cleaning, visual inspection, lubrication, etc. Preventive maintenance performed on a regular basis will help prevent instrument failure and will improve reliability of this instrument. The severity of the environment to which the Type 284 is subjected will determine the frequency of maintenance.

Cleaning

The Type 284 should be cleaned as often as operating conditions require. Accumulation of dirt in the instrument can cause overheating and component breakdown. Dirt on components acts as an insulating blanket and prevents efficient heat dissipation. It also provides an electrical conduction path.

The Type 284 case provides protection against dust in the interior of the instrument. Operating without the case will require more frequent cleaning.

CAUTION

Avoid the use of chemical cleaning agents which might damage the plastics used in this instrument. Some chemicals to avoid are benzene, toluene, xylene, acetone or similar solvents.

Exterior. Loose dust accumulated on the outside of the Type 284 can be removed with a soft cloth or small paint brush. The paint brush is particularly useful for dislodging dirt on and around the front-panel controls. Dirt which remains can be removed with a soft cloth dampened in a mild solution of water and detergent. Abrasive cleaners should not be used.

Interior. Dust in the interior of the instrument should be removed occasionally due to its electrical conductivity under high-humidity conditions. The best way to clean the interior is to blow off the accumulated dust with dry, low-velocity air. Remove any dirt which remains with a soft paint brush or a cloth dampened with a mild detergent and water solution. A cotton-tipped applicator is useful for cleaning in narrow spaces.

Lubrication

The reliability of potentiometers, rotary switches and other moving parts can be increased if they are kept properly lubricated. Use a cleaning-type lubricant (such as Tektronix Part No. 006-0218-00) on switch contacts. Lubricate switch detents with a heavier grease (such as Tektronix Part No. 006-0219-00). A lubrication kit containing the necessary lubricant and instructions is available from Tektronix. Order Tektronix Part No. 003-0342-00.

Visual Inspection

The Type 284 should be inspected occasionally for such defects as broken connections, improperly seated transistors, damaged circuit boards and heat-damaged parts.

The remedy for most visible defects is obvious; however, care must be taken if heat-damaged parts are located. Overheating is usually only a symptom of trouble. For this reason, it is essential to determine the actual cause of overheating before the heat-damaged parts are replaced; otherwise, the damage may be repeated.

Recalibration

To assure accurate measurements, check the calibration of this instrument after each 500 hours of operation or once every six months.

Parts Identification

Identification of Switch Wafers. Wafers of switches shown on the circuit diagrams are numbered from the first wafer located behind the detent section of the switch to the last wafer. The letters F and R indicate whether the front or the rear of the wafer is used to perform the particular switching function. For example, the designation 2R printed by a switch section on a schematic identifies the switch section as being on the rear side of the second wafer when counting back from the front panel.

Wiring Color Code. The wiring in the Type 284 is coded to facilitate circuit tracing. All leads that clip to the permanently mounted circuit boards are color coded. The color code of each lead and the pin lettering is shown in parts location figures later on in this section.

Resistor Coding. The Type 284 uses a number of very stable metal film resistors identified by their gray background color and color coding.

If the resistor has three significant figures with a multiplier, the resistor will be EIA color coded. If it has four significant figures with a multiplier, the value will be printed

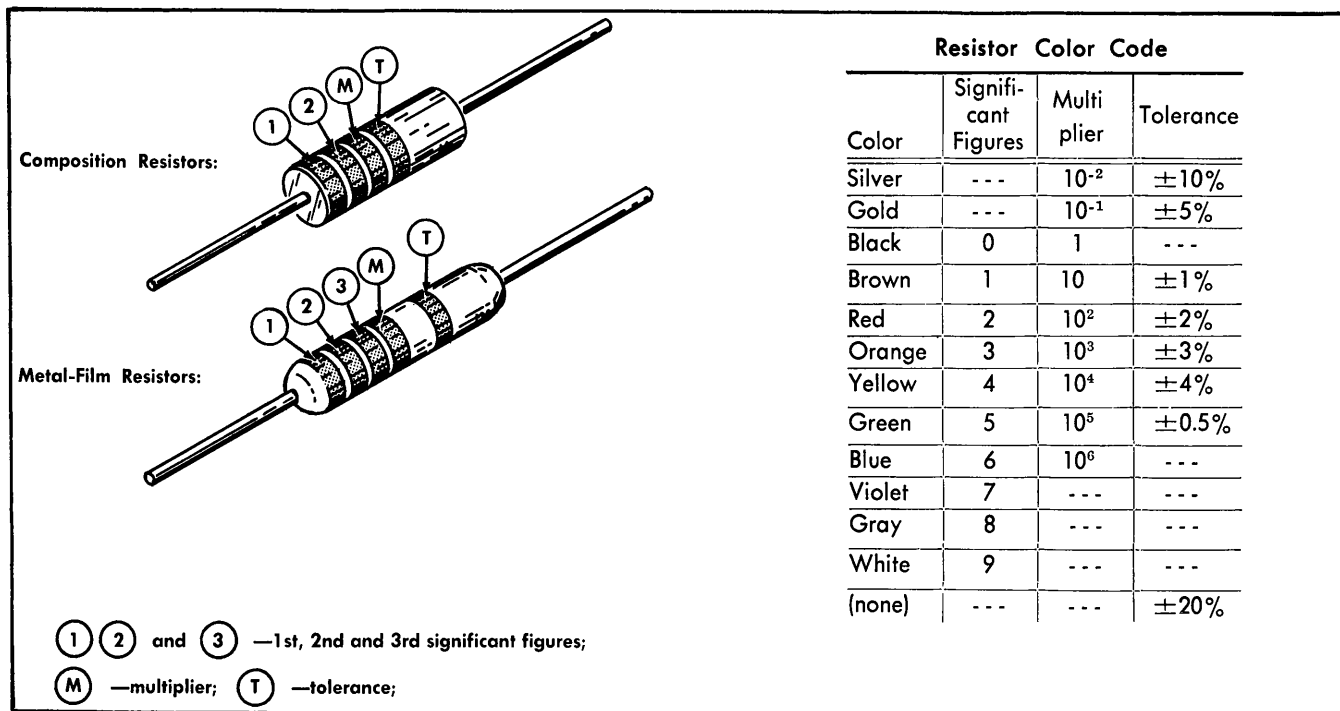

Fig. 4-1. Resistor color code.

on the resistor. For example, a 333 kΩ resistor will be color coded, but a 333.5 kΩ resistor will have its value printed on the resistor body.

The color-coding sequence is shown in Fig. 4-1.

Capacitor Marking. The capacitance values of common disc capacitors and small electrolytics are marked in microfarads on the side of the component body.

Diode Color Code. The cathode end of each glass-enclosed diode is indicated by a stripe, a dot or a series of stripes. For normal silicon or germanium diodes the stripes also indicate the type of diode, using the resistor color-code system (e.g., 6185 indicates the type of diode with Tektronix Part No. 152-0185-00). The cathode and anode ends of metal-encased diodes can be distinguished by the diode symbol marked on the body or by the flared end of the diode.

Parts Replacement

All parts used in the Type 284 can be purchased directly through your Tektronix Field Office or Representative. However, replacements for standard electronic items can generally be obtained locally in less time than is required to obtain them from Tektronix. Replacements for the special parts used in the assembly of the Type 284 should be ordered from Tektronix since these parts are either manufactured or selected by Tektronix to satisfy a particular requirement. Before purchasing or ordering, consult the Electrical Parts List to determine the value, tolerance and ratings required.

NOTE

When selecting the replacement parts, it is important to remember that the physical size and shape of a component may affect its performance at high frequencies. Parts orientation and lead dress should duplicate those of the original part since many of the components are mounted in a particular way to reduce or control stray capacitance and inductance. After repair, portions of the instrument may require recalibration.

Power Supply Filter Capacitors. Replacement requires the removal of the rear chassis plate for access; remove the securing bolts and move the plate to the side. Unsolder the capacitor leads and push the capacitor from the clamp towards the rear of the unit.

Install the replacement capacitor, solder the leads and align the rear plate before tightening the securing bolts. Set the unit on a flat surface and hold firmly as the bolts are tightened.

Rotary Switches. Individual wafers or mechanical parts of rotary switches are normally not replaced. If a switch is defective, replace the entire assembly. The availability of replacement switches, either wired or unwired, is detailed in the Electrical Parts List.

Circuit Boards. Use ordinary 60/40 solder and a 35- to 40-watt pencil type soldering iron on the circuit boards. The tip of the iron should be clean and properly tinned for best heat transfer to the solder joint. A higher wattage soldering iron may separate the etched wiring from the base material.

Replacement of other soldered-in components. Grip the component lead with long-nose pliers. Touch the soldering iron to the lead at the solder connection. Do not lay the iron directly on the board, as it may damage the board. Refer to Fig. 4-2.

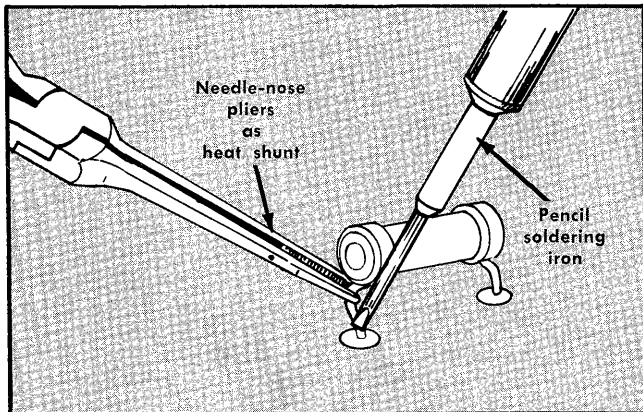

Fig. 4-2. Apply the soldering iron to the heat-shunted lead when removing a component from a circuit card.

When the solder begins to melt, pull the lead out gently. This should leave a clean hole in the board. If not, the hole can be cleaned by reheating the solder and placing a sharp object such as a toothpick or pointed tool into the hole to clean it out.

Bend the leads of the new component to fit the holes in the board. If the component is replaced while the board is mounted in the instrument, cut the leads so they will just protrude through the board.

Pre-tin the leads of the component by applying the soldering iron and a small amount of solder to each (heat-shunted) lead. Insert the leads into the board until the component is firmly seated against the board. If it does not seat properly, heat the solder and gently press the component into place.

Apply the iron and a small amount of solder to the connection to make a firm solder joint. To protect heat-sensitive components, hold the lead between the component body and the solder joint with a pair of long-nose pliers or other heat sink.

Clip the excess lead that protrudes through the board.

Clean the area around the soldered connection with a flux-remover solvent to maintain good environmental characteristics. Be careful not to remove information printed on the board.

Most of the components mounted on the circuit boards can be replaced without removing the boards from the instrument. However, if the underside of the board must be reached, only the mounting screws need be removed. The interconnecting wires allow the board to be moved out of the way or turned over without unsoldering the leads.

Leadless Capacitors. There are leadless ceramic capacitors soldered directly to the Pulse Generator circuit board.

Care must be taken when replacing these capacitors as they are easy to crack. The type of solder used must be high quality, with good cold-flow characteristics. Thus, do not use 50/50 solder, but 60-40 or 62-38 solder when replacing the leadless capacitors.

Use only enough solder to obtain a good full-flow joint. Excess solder on either side of the capacitor can lead to a short circuit.

Metal Terminals. When soldering metal terminals (e.g., switch terminals, potentiometers, etc.), ordinary 60-40 solder can be used. The soldering iron should have a 40- to 75-watt rating with a $\frac{1}{8}$ inch wide chisel-shaped tip.

Observe the following precautions when soldering metal terminals:

1. Apply only enough heat to make the solder flow freely.
2. Apply only enough solder to form a solid connection. Excess solder may impair the function of the part.
3. If a wire extends beyond the solder joint, clip off the excess.
4. Clean the flux from the solder joint with flux-remover solvent to maintain good environmental characteristics.

Power On Indicator Replacement. The Power On Indicator is an incandescent lamp which is installed in the screw-in holder.

Fuse Replacement. The line fuses are located on the Selector Panel cover at the rear chassis plate. Remove the Selector Panel cover for access to the LINE FUSE, 1/10A Slow, and the 230 V FUSE, 1/16A Slow.

Transistor Replacement. Transistors should not be replaced unless actually defective. If removed during routine maintenance, return them to their original sockets or locations.

For metal case transistors (four leads), mounted directly to the circuit board, a small triangle is etched into the area in front of the tab on the transistor. Other circuit board mounted transistors follow the configuration of collector, base, emitter (clockwise on the socket) as do the socket-mounted transistors; see Fig. 4-3. Power transistors are electrically insulated from the mounting chassis.

Circuit Board Replacement. If a circuit board is damaged and cannot be repaired, the entire assembly including all soldered-on components should be replaced. The part number given in the Mechanical Parts List is for the completely wired board.

Both circuit board assemblies are secured by screws (6 each) to the chassis. Connections are made with pin connectors. To remove the circuit board, remove the screws and the pin connections.

Transformer Replacement. The transformer is mounted by two screws, located on each side of the soldered connections. Be certain that the circuit boards do not touch the transformer and that the transformer leads do not short.

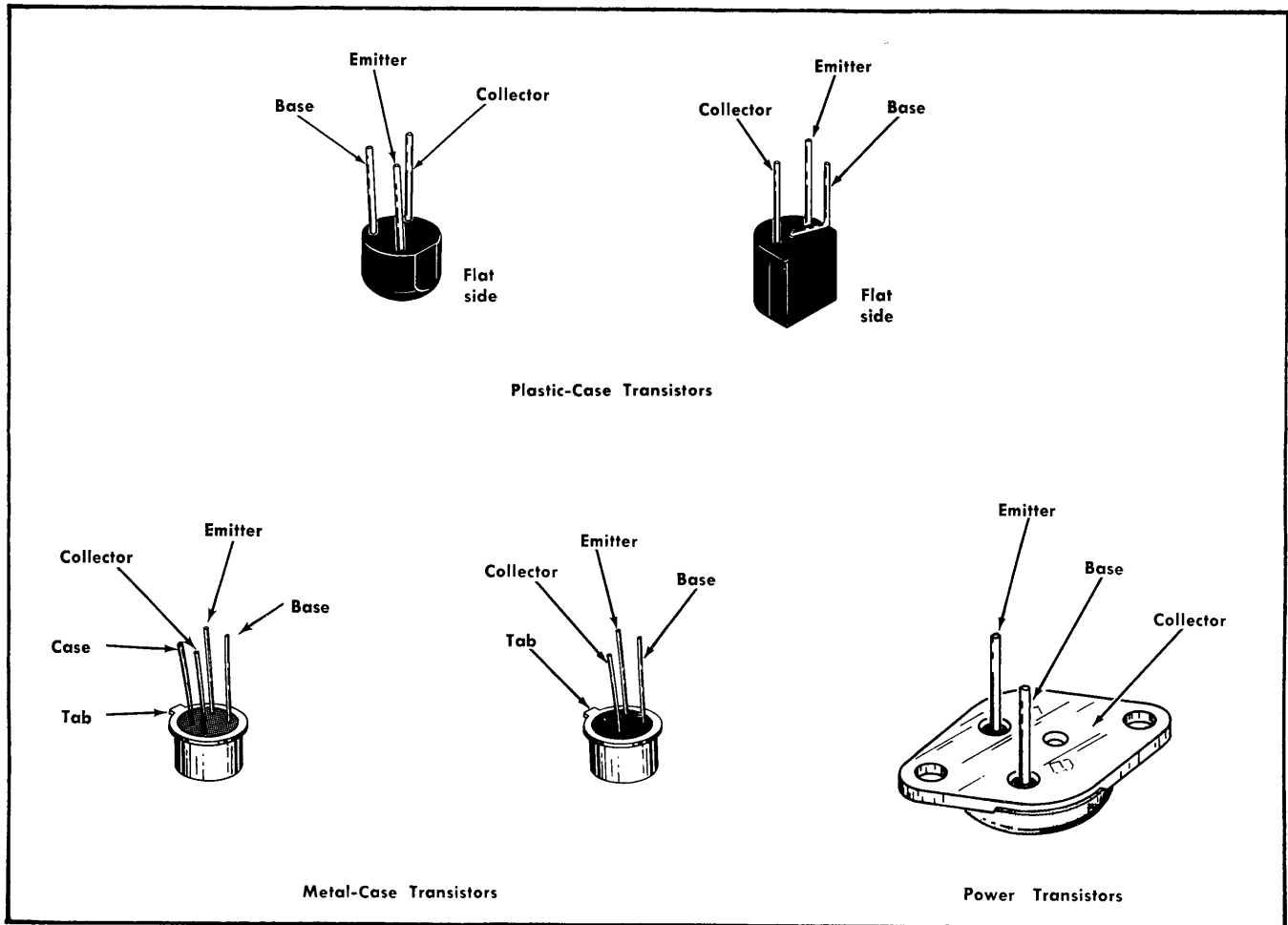

Fig. 4-3. Type 284 transistor cases.

Tunnel Diode Pulsar Replacement. Components within the assembly are the terminating resistors, R184, (A, B and C supplied as a unit), R180 and the tunnel diode, D180. Parts C185 and C186 are extensions of the center conductors, J185 and J186.

Pulse Assembly Removal. Disconnect the four connectors, loosen the retaining nut, slide the assembly back to clear the front ring, then release the assembly from the clamp and lift it from the Type 284; see Fig. 4-4.

Loosen the retaining ring near the "B" section shown in Fig. 4-4A. The center conductor shaft of the 50 Ω airline will be loosened. The tunnel diode holder is removed with tweezers. Be certain the new diode is placed correctly (shown in Fig. 4-4B). R180 is pushed into a pressure holder for contact at the tunnel diode end and soldered at the connector end. The tunnel diode holder must be removed to install the resistor, and the resistor lead length is critical.

Loosen the retaining ring near the "C" section shown in Fig. 4-4A. The center conductor shaft of the 50 Ω airline will be completely free. The termination resistors are removed as one unit; unsolder the lead to the rear connector and allow the unit to drop out. In re-assembly be sure to tighten the retaining ring before re-soldering the lead. In-

stall the termination resistors, set the center conductor shaft so the shoulder rides on the termination resistor, place the outer conductor (see Fig. 4-4D) to the termination and tighten the retaining ring. Solder the lead.

Replace the Section "B", the tunnel diode, Fig. 4-4A, visually align both sections approximately, and tighten the retaining rings.

Install the assembly in the Type 284; snap into the clamp, push snugly into the front and tighten the nut. Reconnect the connectors; see Fig. 4-4A for color coding.

TROUBLESHOOTING

Attempt to isolate trouble to one circuit through operational and visual checks. Verify that the apparent trouble is actually a malfunction within the Type 284, and not improper control settings or malfunctioning associated equipment. Note the effect the controls have on the trouble symptoms. Normal and abnormal operation of each control helps establish the location and nature of the trouble. Control functions are described in the Operations section.

Check the instrument calibration procedure given in Section 6, and note the position of each adjustment so it can

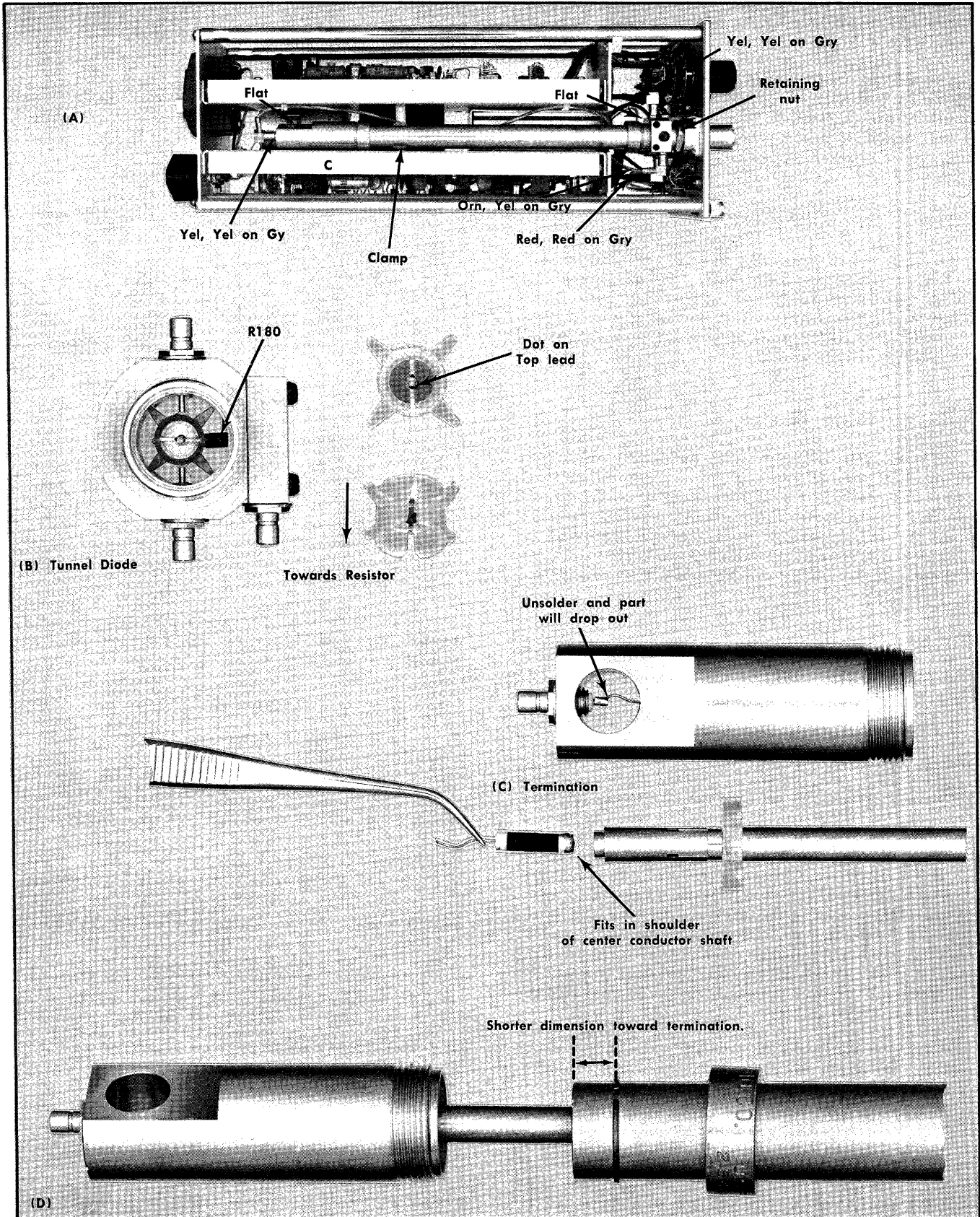

Fig. 4-4. Tunnel Diode Pulsar assembly.

Maintenance—Type 284

be returned to its original position after the check. This will facilitate recalibration after the trouble has been found and corrected.

Check circuit voltages and waveforms against those shown in Section 9 of the manual. Component layout information is included in this section. It is usually best, if the trouble is not isolated to a circuit, to start with the power supply circuit then proceed consecutively from one circuit to the next.

CAUTION

Use care when measuring voltages or waveforms. The small size and high density of components in this instrument establishes a condition such that an inadvertent movement of the test probe or the use of oversized probes may cause a short-circuit between components.

In-Circuit Diode Checks

In-circuit diode checks may be performed with a voltmeter. A comparison check of the voltages on each side of the diode with the typical voltages listed on the diagram will help isolate faulty diodes. Forward-to-back resistance ratios on some diodes can be checked by referring to the schematic and pulling appropriate transistors and pin connectors to remove low resistance loops around the diode.

CAUTION

Do not use an ohmmeter scale that has a high internal current. Do not check the forward-to-back resistance ratios of the tunnel diode.

Transistor Checks

Transistors should not be replaced unless they are actually defective. Transistor defects usually take the form of the transistor opening, shorting or developing excessive leakage. To check a transistor for these and other defects, use a transistor curve display instrument such as a Tektronix Type 575. However, if a good transistor checker is not readily available, a defective transistor can be found by signal-tracing, by making in-circuit voltage checks, by measuring the transistor forward-to-back resistance using proper ohmmeter resistance ranges, or by using the substitution method. The location of all transistors is shown in the parts location figures later in this section.

To check transistors using a voltmeter, measure the emitter-to-base and emitter-to-collector voltages and determine whether the voltages are consistent with the normal resistances and currents in the circuit (see Fig. 4-5).

To check a transistor using an ohmmeter, know your ohmmeter ranges, the currents they deliver, and the internal battery voltage(s). If your ohmmeter does not have sufficient resistance in series with its internal voltage source, excessive current will flow through the transistor under test. Excessive current and/or high internal source voltage may permanently damage the transistor.

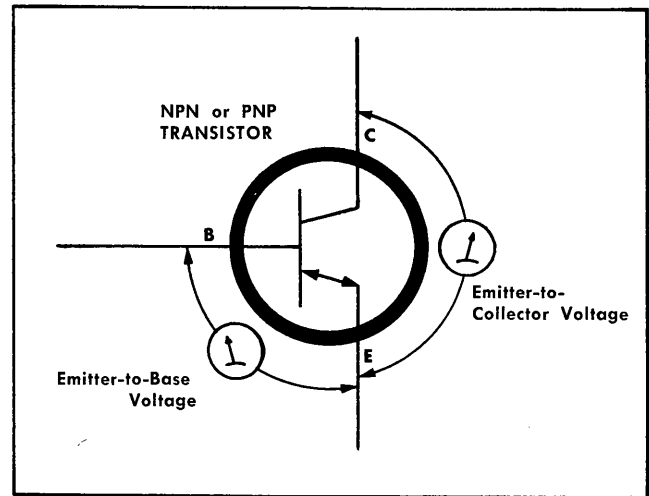

Fig. 4-5. In-circuit voltage checks NPN or PNP transistors.

NOTE

As a general rule, use the $R \times 1 \text{ k}$ range where the current is usually limited to less than 2mA and the internal voltage is usually $1 \frac{1}{2}$ volts. You can quickly check the current and voltage by inserting a multimeter between the ohmmeter leads and measuring the current and voltage for the range you intend to use.

When you know which ohmmeter ranges will not harm the transistor, use those ranges to measure the resistance with the ohmmeter connected both ways as given in Table 4-1.

TABLE 4-1

Transistor Resistance Checks

Ohmmeter Connections ¹	Resistance Reading That Can Be Expected Using the $R \times 1 \text{ k}$ Range
Emitter-Collector	High readings both ways (about 60 k Ω to around 500 k Ω).
Emitter-Base	High reading one way (about 200 k Ω or more). Low reading the other way (about 400 Ω or 2.5 k Ω).
Base-Collector	High reading one way (about 500 k Ω or more). Low reading the other way (about 400 Ω to 2.5 k Ω).

¹Test prods from the ohmmeter are first connected one way to the transistor leads and then the test prods are reversed (connected the other way). Thus, the effects of the polarity reversal of the voltage applied from the ohmmeter to the transistor can be observed.

If there is doubt about whether the transistor is good, substitute a new transistor; but first, be certain the circuit voltages applied to the transistor are correct before making the substitution.

When checking transistors by substitution, be sure that the voltages on the transistor are normal before making the substitution. If a transistor is substituted without first checking out the circuit, the new transistor may immediately be damaged by some defect in the circuit.

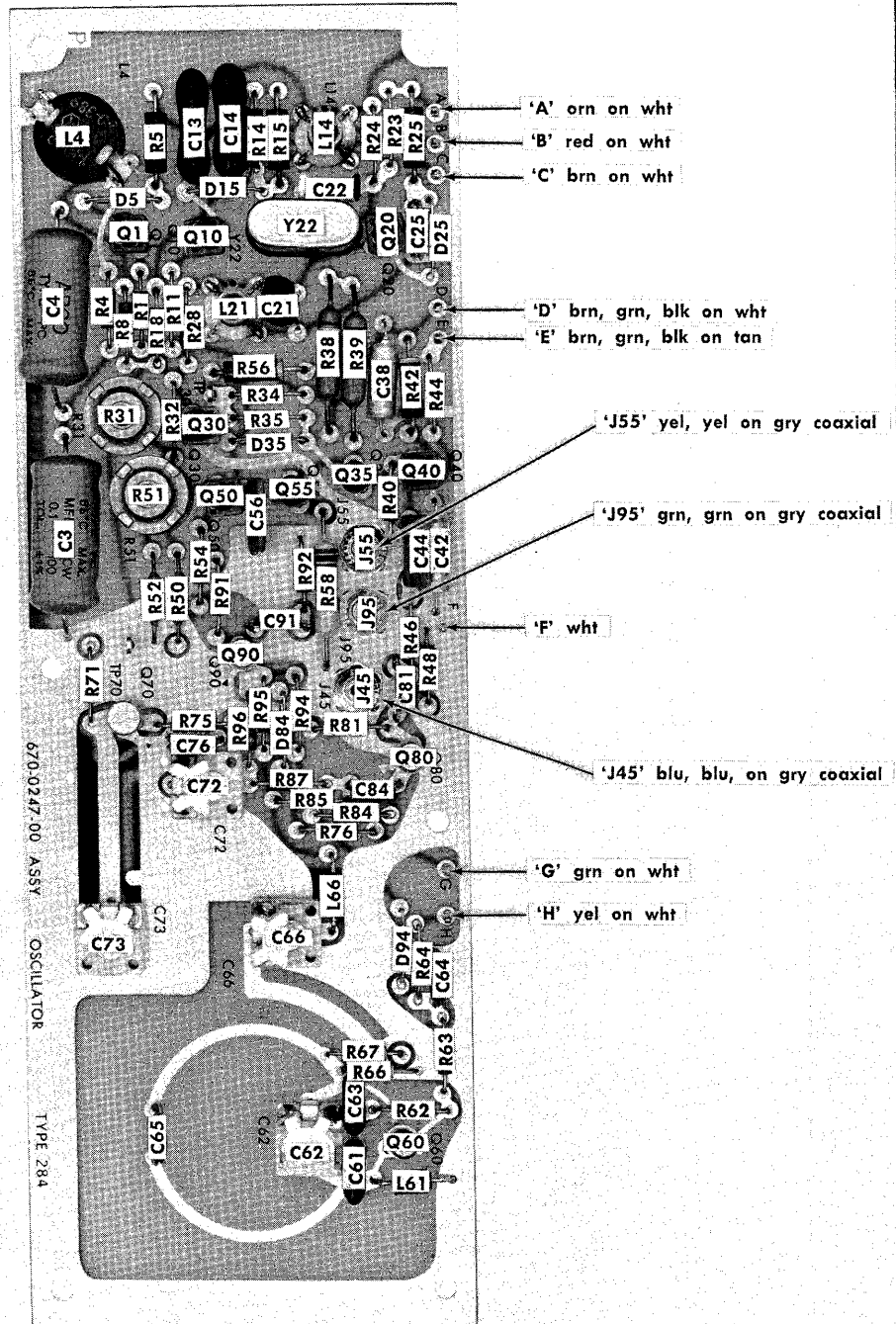

Fig. 4-6. Calibrator circuit board assembly.

SECTION 5

PERFORMANCE CHECK

Change information, if any, affecting this section will be found at the rear of the manual.

Introduction

This section of the manual provides a means of rapidly checking the performance of the Type 284. It is intended to check the calibration of the instrument without the need for performing the complete Calibration procedure. The performance check does not provide for the adjustment of any internal controls. Failure to meet the requirements given in this procedure indicates the need for internal checks or adjustments, and the user should refer to the Calibration Procedure in this manual.

EQUIPMENT REQUIRED

The following (or equivalent) items of equipment are required for a complete performance check of the Type 284. Equipment requirements given here are the minimum requirements for making the sequence of checks. All test instruments are assumed to be calibrated and operating within their rated specifications. If substitute equipment is used, it must equal or exceed the given requirements in order to check the Type 284 to the given accuracy.

1. Test oscilloscope with a deflection factor of 0.5 volts minimum, added inputs and a bandwidth of at least 10 MHz. Tektronix Type 545B Oscilloscope and Type 1A1 Plug-In Unit recommended.

2. A precision, non-loading DC voltmeter with the following minimum tolerances; $\pm 0.05\%$ at 1 volt, $\pm 0.1\%$ at 100 mV and $\pm 0.15\%$ at 10 mV. A John Fluke Model 801B voltmeter meets these requirements.

3. Spectrum analyzer plug-in unit with frequency coverage of 100 MHz and 1 GHz with calibrated dispersion of .5 and 5 MHz/cm $\pm 10\%$. Tektronix Type 1L20 Spectrum Analyzer Plug-In Unit recommended.

4. Reflectometer for Time-Domain Reflectometry measurements. Vertical deflection $0.02 \rho \pm 3\%$ and horizontal deflection of 10 cm/division $\pm 3\%$. Tektronix Type 1S2 Sampling Unit recommended.

5. Time mark generator, with marker or sine wave outputs of 10 μ s, 1 μ s, 100 ns, 10 ns and 2 ns with an accuracy of 0.005%. Tektronix Type 184 Time Mark Generator recommended.

6. Sampling Oscilloscope dual trace, risetime 350 ps. Tektronix Type 661 with Type 4S1 and Type 5T3 Plug-In Units recommended.

7. Sampling Plug-In Unit, risetime minimum 90 ps. Tektronix Type 4S2A recommended. Type 1S2 may be substituted.

8. Sampling Plug-In Unit, input RC of 100 k Ω parallel with 2 pF. Type 4S3 with P6038 recommended. Type 3S3 with 560-series Oscilloscope and Sampling Time Base may be substituted.

9. 50 Ω "T" type pickoff, Tektronix Type VP-2 recommended. Tektronix Part No. 017-0077-00.

10. Two 50 Ω coaxial cables, 42 inch length, type RG58 with BNC connectors. Tektronix Part No. 012-0057-01.

11. Two 50 Ω coaxial cables, 5 ns signal delay, type RG213U with GR connectors. Tektronix Part No. 017-0502-00.

12. Patch cord, length about 18 inches, banana plugs. Tektronix Part No. 012-0031-00.

13. Attenuator, 10 \times , GR 874-G20. Tektronix Part No. 017-0078-00.

14. Attenuator, 5 \times , GR 874-G14. Tektronix Part No. 017-0079-00.

15. Attenuator, 2 \times , GR 874-G6. Tektronix Part No. 017-0080-00.

16. Adapter, GR to BNC female. Tektronix Part No. 017-0063-00.

17. Adapter, GR to BNC male. Tektronix Part No. 017-0064-00.

18. Adapter, GR to BNC male, 50 Ω thru-line termination. Tektronix Part No. 017-0083-00.

19. Standard type 50 Ω $\pm 0.05\%$ precision resistor, used with the precision voltmeter and VP-2 voltage pickoff to check amplitude accuracy. General Radio Type 500-C 50 ohm $\pm 0.035\%$ meets this requirement.

20. BNC to Clip Lead adapter. Tektronix Part No. 013-0076-00.

21. Adapter, GR to N male. Tektronix Part No. 017-0021-00.

22. Two 90° Elbows, GR 874-EL, use with Type 1S2. Tektronix Part No. 017-0070-00.

23. Tee, GR 874-T. Tektronix Part No. 017-0069-00.

24. 20 cm Airline, GR 874-L20. Tektronix Part No. 017-0084-00.

25. End-line termination, GR 874-W50B. Tektronix Part No. 017-0081-00.

26. 50 Ω termination, BNC connectors. Tektronix Part No. 011-0049-00.

27. Pocket screwdriver with shank at least 2 inches long and a blade width of approximately $\frac{3}{32}$ inch. Tektronix Part No. 003-0192-00.

Performance Check—Type 284

Preliminary Procedure

1. Control check. Check all front-panel controls for proper indexing and correct any defects found.
2. Connect the power cord to the line voltage for which the Type 284 is set.
3. For step 1 only, remove the Type 284 from the case and take out Q35. See Fig. 5-1 for location.

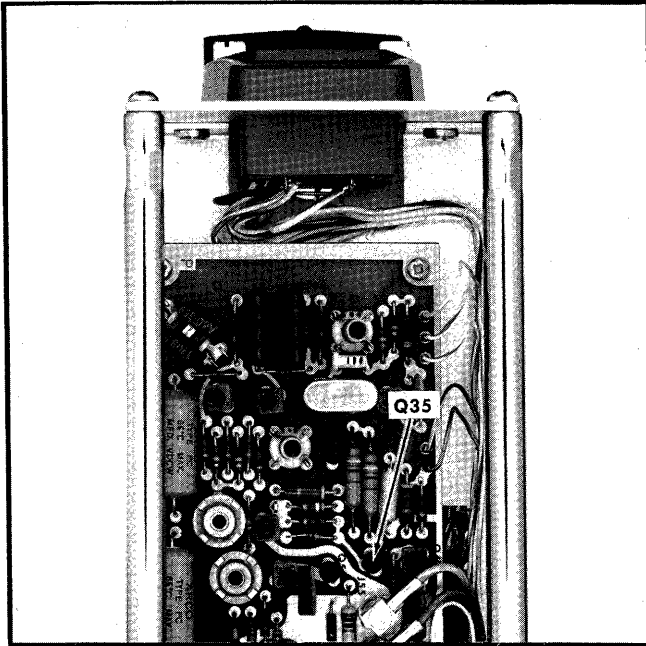

Fig. 5-1. Location of Q35.

4. Set the POWER on.
5. Set the controls as follows:

Type 284	
SQUARE WAVE AMPLITUDE	1 V
PERIOD	10 μ s
MODE	SQUARE WAVE OR SINE WAVE OUTPUT
LEAD TIME	5 ns

Set the precision voltmeter to measure 1 volt.

PERFORMANCE CHECK PROCEDURE

General

In the following procedure, test equipment connections or control settings should not be changed except as noted. If only a partial check is desired, refer to the preceding step(s) for setup information.

The following procedure uses the equipment listed under Equipment Required. If substitute equipment is used, con-

trol settings or setup must be altered to meet the requirements of the equipment used.

1. Check Square Wave Amplitude Accuracy

a. Requirement—Accuracy at 1 V is $\pm 0.5\%$ at 10 μ s and 1 μ s, and $\pm 2\%$ at 100 ns, 20 ns after transition. At 10 μ s, 100 mV $\pm 1\%$ and at 10 mV $\pm 1.5\%$.

b. Equipment—Precision nonloading DC voltmeter, 50 Ω precision resistor with clip lead adapter, GR to BNC adapter, VP-2 adapter, 50 Ω end-line termination, Type 4S3 with P6038, Type 661 and Type 5T3.

c. Connect the 50 Ω resistor through a clip lead adapter, BNC to GR adapter and voltage pickoff (VP-2) to the SQUARE WAVE OR SINE WAVE OUTPUT. Connect the precision DC voltmeter across the resistor. (If the precision resistor with a single coaxial connector is used, a Tee connector can be used.)

d. Set the voltmeter for a 1 volt measurement at the most sensitive null range.

e. Check that the voltage measures 1 volt ± 5 mV.

f. Set the SQUARE WAVE AMPLITUDE switch to 100 mV.

g. Check that the voltage measures 100 mV ± 1 mV.

h. Set the SQUARE WAVE AMPLITUDE switch to 10 mV.

i. Check that the voltage measures 10 mV ± 0.15 mV.

j. Change the SQUARE WAVE AMPLITUDE switch to 1 V, disconnect the voltmeter from the resistor and place the P6038 probe tip (from Channel A of the Type 4S3) into the voltage pickoff VP-2.

k. Set the Sampling Oscilloscope controls as follows:

Type 661

Horizontal Display	$\times 1$
Position and Vernier	Midrange

Type 4S3

Millivolts/cm	20
Variable	Calibrated
Mode	A Only
Vertical Position	Midrange
DC Offset	Midrange
Display	Normal
Smoothing	Unit dot response (about 45° from clockwise position)
Low Noise-Fast Risetime	Fast Risetime

Type 5T3

Equivalent Time/cm	1 μ s
Variable	Cal
Samples/cm	100
Time Position and Fine	Clockwise
Sweep Mode	Norm

Trigger Level	Midrange
Stability or UHF Sync	Midrange
Trig Source	Free Run
Slope	—
Ext Trig Mode	50 Ω AC

l. Change the DC Offset counterclockwise, and the Position control to position the 1 V DC trace to the center of the graticule. Do not change this control after it is set, so that voltage comparison can be made.

m. Re-install Q35 in its socket. Connect the Trigger Output signal from the TRIGGER OUTPUT connector through a BNC to GR adapter and a 5 ns 50 Ω coaxial cable to the Ext Trig Input connector on the Type 5T3.

n. Set the Trig Source to Ext and set the Trigger Level control for a stable display. Observe the upper portion of the square wave within ±5 mV of the center of the graticule; step (l) set the vertical position (see Fig. 5-2).

o. Set the PERIOD switch to 1 μs and change the Equivalent Time/cm switch to .1 μs/cm.

p. Check—Upper portion of the waveform (as in step n) is within ±5 mV of the center of the graticule.

q. Change the PERIOD switch to 100 ns, the Equivalent Time/cm switch to 10 ns/cm and remove the resistor, clip lead adapter and BNC to GR adapter. Connect the 50 Ω end-line termination to the VP-2.

r. Check—Upper portion of the waveform is within 20 mV after the first 20 ns; see Fig. 5-2.

s. Disconnect the VP-2 and reinstall the Type 284 in its case.

c. Connect a 50 Ω coaxial cable from the SQUARE WAVE OR SINE WAVE OUTPUT connector to the Oscilloscope/Type 1A1 Input 1 connector through a 50 Ω thru-line GR to BNC termination.

d. Set the controls as follows (oscilloscope and Type 1A1):

Triggering	—Int, AC
Time/cm	1 μs
Mode	CH 1
Volts/cm	.2
Input Selector	AC

e. Set the Type 284 SQUARE WAVE AMPLITUDE switch to 1 V and the PERIOD switch to 10 μs.

f. Set both the Variable Time/cm and the Triggering controls for one complete cycle over the center 8 divisions of the graticule as shown in Fig. 5-3. Center the display vertically with the Vert. Position control and check symmetry at the 50% amplitude points.

g. Check—Symmetry is 48% to 52%. The transition is within 0.16 cm of the graticule center line, see Fig. 5-3.

h. Set the Type 284 PERIOD switch to 1 μs and set the oscilloscope Time/cm switch to .1 μs. Adjust the Variable control for one cycle over 8 cm as in part (f) and check the symmetry to be within 48% to 52%.

i. Set the Type 284 PERIOD switch to 100 ns and set the oscilloscope 5× Magnifier on. Adjust the Variable control for one cycle over the center 4 cm and check the symmetry for transition within 0.08 cm of the graticule center line (48% to 52%). (If oscilloscope has a faster time base, use an 8 cm display.)

j. Leave the Type 284 as connected and set the Variable Time/cm control to Calibrated.

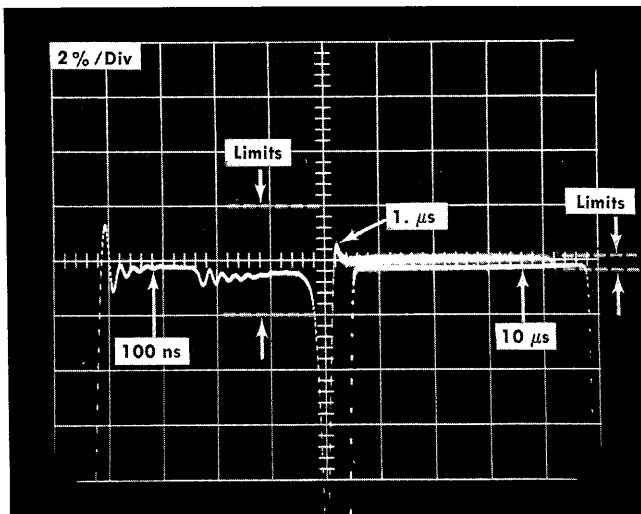

Fig. 5-2. Displays showing Amplitude checks at Square Wave Period settings.

2. Check Square Wave Symmetry

a. Requirement—Square Wave symmetry is 48% to 52%.

b. Equipment—Oscilloscope with Type 1A1 and 50 Ω GR to BNC termination.

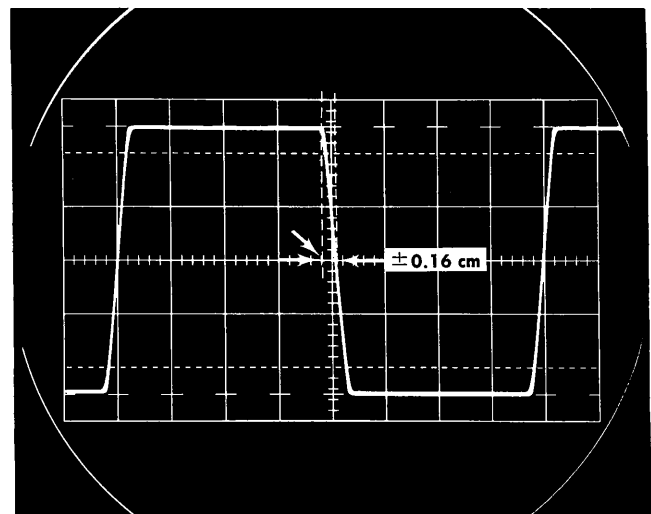

Fig. 5-3. Square wave symmetry.

3. Check Square Wave Period Timing

a. Requirement—Period accuracy within ±0.5% at 10 μs and 1 μs, within ±0.05% at 100 ns.

Performance Check—Type 284

b. Equipment—Oscilloscope with Type 1A1, 50 Ω GR to BNC termination and Time Mark Generator.

c. Connect the time mark generator marker output connector to the oscilloscope Input 2 connector through a 50 Ω coaxial cable.

d. Set the Type 1A1 Mode switch to Add and both Volts/cm switches to .5.

e. Set the Type 284 PERIOD switch to 10 μs and set the Time Mark Generator for 10 μs time markers. Internally trigger the test oscilloscope on the beat frequency displayed. Fig. 5-4 shows the typical displays.

NOTE

The beat or difference frequency is formed by the variation in amplitude which occurs when two signals of different frequency are mixed. Two signals of the same frequency produce no observed variation in amplitude.

f. Measure the beat frequency time per cycle of the test oscilloscope display. The tolerance is computed as follows:

$$f = \frac{1}{T} = \frac{1}{10 \mu s} = 100 \text{ kHz}$$

$$100 \text{ kHz} \times 0.5\% = 500 \text{ Hz}$$

$$T = \frac{1}{f} = \frac{1}{500} = 2 \text{ ms/cycle (minimum time per difference frequency cycle)}$$

g. Measure the frequency for the 1 μs and 100 ns positions of the PERIOD switch as listed in Table 5-1.

TABLE 5-1

PERIOD	Time Mark Generator	Tolerance	Minimum Time per cycle of beat frequency
10 μs	10 μs	±0.5%	2 ms
1 μs	1 μs	±0.5%	0.2 ms
100 ns	.1 μs	±0.05%	0.2 ms

h. Disconnect both signal cables.

4. Check Square Wave Trigger Amplitude

a. Requirement—Square Wave Trigger amplitude is 200 mV ±20%.

b. Equipment—Oscilloscope with Type 1A1 and 50 Ω termination.

c. Connect the TRIGGER OUTPUT connector to the oscilloscope Input 1 connector through a 50 Ω coaxial cable and 50 Ω termination.

d. Set the Volts/cm switch to .05 and the Mode switch to CH 1. Set the Time/cm switch to .1 μs and the Triggering controls for a stable display, see Fig. 5-5.

e. Check—Trigger amplitude is 4 cm ±0.8 cm (200 mV ±40 mV).

f. Disconnect the coaxial cable.

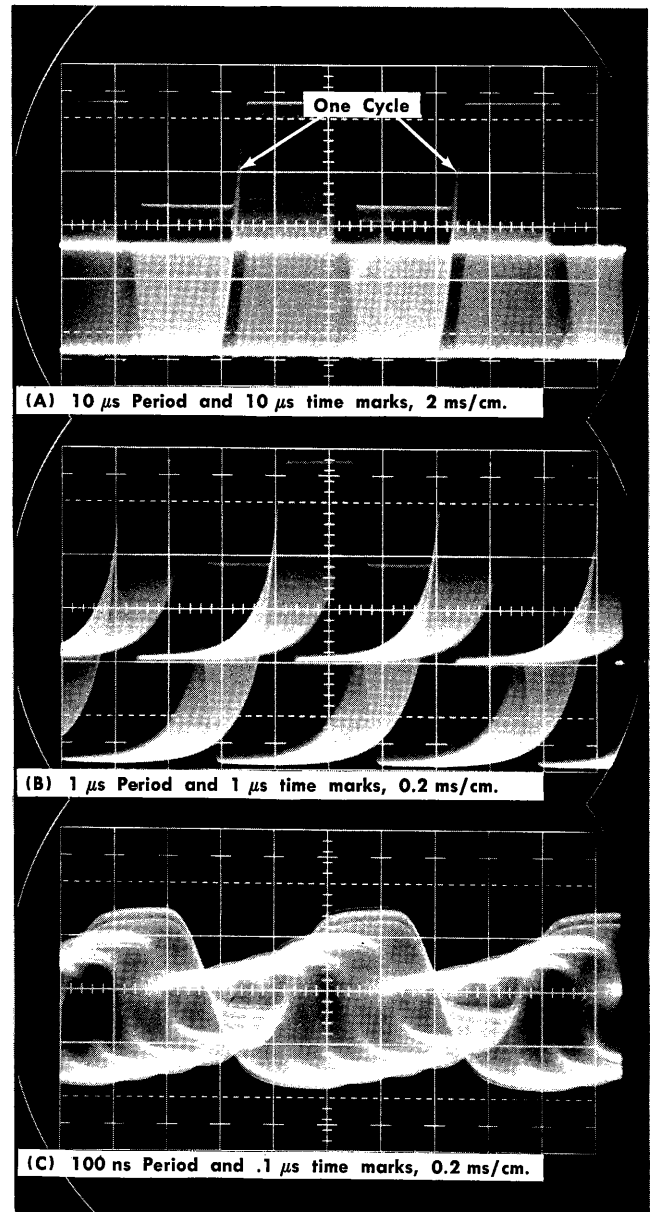

Fig. 5-4. Typical displays of beat frequency.

5. Check Sine Wave Period Timing

a. Requirement—Sine Wave Period within ±1% at 10 ns and 1 ns.

b. Equipment—Oscilloscope with Type 1L20, GR Tee connector, attenuators 10×, 5× and 2×, GR to BNC male and female adapters, N to GR adapter and the Time Mark Generator.

c. Set the oscilloscope and Type 1L20 controls as follows:

- Horizontal Display A
- Time/cm 1 ms
- Stability Clockwise

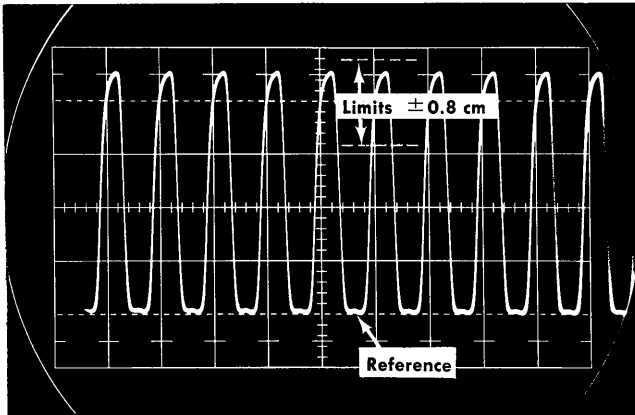

Fig. 5-5. Display of Trigger Output signal.

IF Atten	20 dB on, all others off
IF Center Freq	Midrange (000)
Fine IF Center Freq	Midrange
RF Center Freq	100
Dispersion Range	MHz/CM
Dispersion/Coupled Resolution	.5
Video Filter	Off (down)
Vertical Display	Log
RF Inputs (switch)	Band 1
Gain	Midrange
Position	Midrange

Check that the Type 1L20 is properly mated to the Oscilloscope by setting SW101 (slide switch on the rear plate of the 1L20) to correct position (—150 V for Type 545B), and by checking the calibration of the front panel IF Center Freq Cal and Disp Cal adjustments. Refer to the Type 1L20 instruction manual

d. Set the Time Mark Generator for 10 ns and 1 μ s output markers.

e. Connect the equipment as follows:

Patch cord (banana plug) from Sawtooth A to Type 1L20 Sweep Input connector.

Time Mark Generator Marker Output, 50 Ω coaxial cable, adapter, 2 \times attenuator and 10 \times attenuator to the GR Tee connector.

Type 284 SQUARE WAVE OR SINE WAVE OUTPUT connector to 5 \times attenuator and the GR Tee connector.

GR Tee connector, 5 ns cable, GR to BNC adapter to Type 1L20 Band 1 connector.

f. Set the Type 284 MODE switch to PULSE OUTPUT to establish a reference with the Time Mark Generator signal; see Fig. 5-6A. Slight changes in IF Center Freq, Gain, RF Center Freq and Position controls may be necessary to obtain this display of 100 MHz at the center of the graticule with 1 MHz markers every 2 cm.

Since the signal from the Time Mark Generator is a harmonic of the IF frequency of the Type 1L20, the signal can feed through the mixer and appear on the CRT without mixing with the local oscillator. This signal can be centered by the IF Center Freq control, but will appear stationary to changes in the RF Center Freq control. In the typical displays in Fig. 5-6, the feed through and the tuned signals are superimposed to appear as one signal. Also note that with the clockwise rotation (increasing frequency) of the RF Center Freq control the true signal display will move across the CRT from left to right.

g. Change the MODE switch to SQUARE WAVE OR SINE WAVE OUTPUT, the PERIOD switch to 10 ns and observe the signal display.

h. Check—10 ns Sine Wave is within limits shown in Fig. 5-6B and C, ± 2 cm ($\pm 1\%$).

i. Change the following connections:

Time Mark Generator Output to H.F. Selector Output, and remove the 2 \times attenuator;

Type 1L20 Band 1 to Band 2-5 connector, and use N to GR adapter.

j. Set the Time Mark Generator H.F. Selector to 2 ns. Set the Type 1L20 RF Input switch to Bands 2-5 and the Dispersion/Coupled Resolution switch to 5 (5 MHz/cm).

k. Set the Type 284 PERIOD switch to 1 ns and the MODE switch to PULSE OUTPUT.

l. Tune the second harmonic of 2 ns (1 GHz) to the center of the graticule with the Type 1L20 controls. Observe that the 1 GHz true signal moves from left to right as the dial frequency is increased. The 1 GHz signal may be superimposed on the IF feed-through response or the IF feed-through may be shifted off the screen with the IF Center Freq control.

m. Set the Type 284 MODE switch to SQUARE WAVE OR SINE WAVE OUTPUT and observe the signals.

n. Check—1 ns Sine Wave is within ± 2 cm ($\pm 1\%$) of the center reference. The 1 ns signal may be superimposed. To verify that you have the true 1 GHz signal from the Type 284, change the RF Center Freq slightly to see if the combined signal display shifts or tracks together.

o. Disconnect all connections.

6. Check Sine Wave Period Amplitude

a. Requirement—Sine Wave Period amplitude is 100 mV $\pm 20\%$.

b. Equipment—Sampling Oscilloscope: Type 661, Type 5T3, Type 4S2A and GR to BNC female adapter.

c. Set the Sampling Oscilloscope controls as follows:

Type 661

Horizontal Display	$\times 1$
Position	Midrange
Vernier (Position)	Midrange

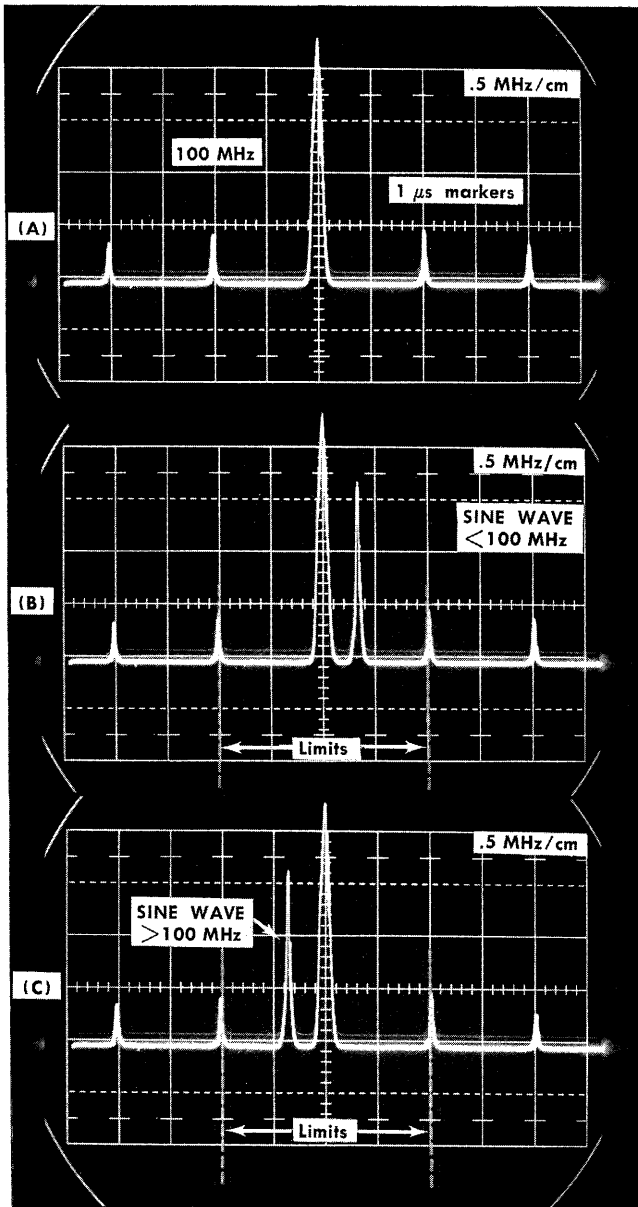

Fig. 5-6. Typical displays using Spectrum Analyzer for (A) reference, (B) and (C) reference and 10 ns sine wave from Type 284.

Type 5T3

Samples/cm	100
Equivalent Time/cm	5 ns, Calibrated
Trigger Level	Midrange
Stability or UHF Sync	Midrange
Trigger Source	Ext
External Trigger Mode	50 Ω AC
Sweep Mode	Norm

Type 4S2A

Millivolts/cm	20
Millivolts/cm Variable	Calibrated

Mode	A Only
Vert Position	Midrange
DC Offset	Midrange (2½ turns from one end)
Smoothing	Fully counterclockwise

d. Connect the Type 284 SQUARE WAVE OR SINE WAVE OUTPUT connector to the Channel A 50 Ω Input connector through a 5 ns cable and connect the TRIGGER OUTPUT connector to the 50 Ω External Input through a 50 Ω coaxial cable and BNC to GR adapter.

e. Set the Type 284 PERIOD switch to 10 ns and the MODE switch to SQUARE WAVE OR SINE WAVE OUTPUT.

f. Set the Trigger Level and positioning controls for a stable sine wave display; see Fig. 5-7.

g. Check—Peak-to-peak amplitude of the sine wave is 5 cm ± 1 cm (100 mV ± 20%).

h. Change the Equivalent Time/cm switch to .5 ns, the External Trigger Mode to UHF Sync and set the Type 284 PERIOD switch to 1 ns.

i. Adjust the Stability control for a stable display.

j. Check—Peak-to-peak amplitude of the sine wave is 5 cm ± 1 cm (100 mV ± 20%).

k. Disconnect the cables.

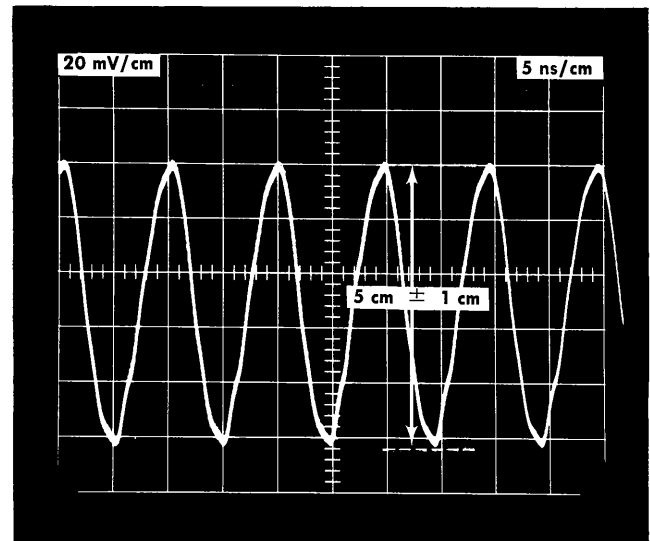

Fig. 5-7. Typical display for checking Sine Wave Period amplitude.

7. Check Sine Wave Trigger Amplitude

a. Requirement—Sine Wave Trigger amplitude is 200 mV ± 40%.

b. Equipment—Same as step 6.

c. Connect the TRIGGER OUTPUT connector to the Channel A Input connector through a 50 Ω coaxial cable and BNC to GR adapter.

d. Change the Timing Unit Trigger Source to Int and the Vertical Unit Millivolts/cm to 100. Set the Trigger Level control for a stable display.

e. Check—Sine wave trigger amplitude is within 2 cm ± 0.8 cm peak to peak (200 mV $\pm 40\%$) see Fig. 5-8.

f. Change the Equivalent Time/cm switch to 5 ns and the Type 284 PERIOD switch to 10 ns. Set the Trigger Level control for a stable display.

g. Check—Sine wave trigger amplitude is within 2 cm ± 0.8 cm peak to peak (200 mV $\pm 40\%$).

h. Disconnect all test equipment.

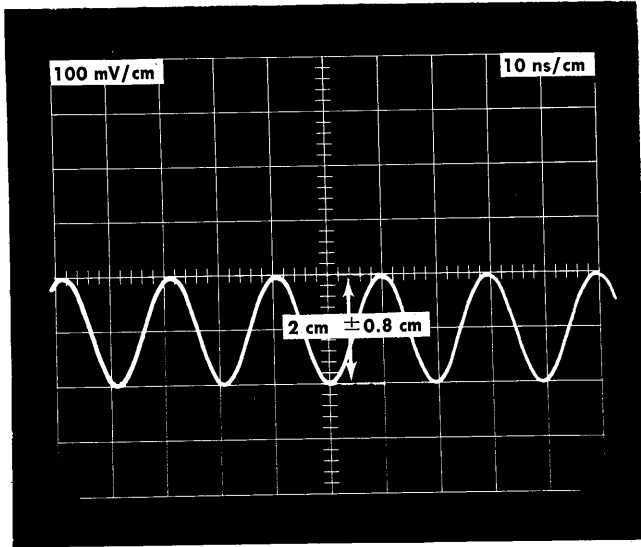

Fig. 5-8. Typical display showing Sine Wave Trigger Output signal.

8. Check Reflections From Pulse Generator

a. Requirement—Reflections not more than $\pm 5\%$ with Type 1S2.

b. Equipment—Oscilloscope with Type 1S2, 20 cm airline, two GR 90° elbows and 50 Ω end-line termination.

c. Set the Oscilloscope and Type 1S2 controls as follows:

Horizontal Display	Ext $\times 1$
Variable 10-1	Adjust for 1 V/cm to mate Type 1S2
Offset	Midrange
Fine	Midrange
Vertical Units/Div	.5
Variable	CAL
Display Mode	Normal
Mode	Int Pulse .25 V 50 ps
UHF Sync or Trigger Sens	Midrange
Magnifier	$\times 10$
Variable	Cal
Range	.1 μ s - 10 ms
Dielectric	Air
Position	0.00
Horizontal Units/div	Distance
ρ —Volts	ρ

Resolution	High
Vert Gain (screwdriver adjustment)	Mated to the Type 545B at .5 ρ /cm (Fig. 5-9A)

d. Join the two GR 90° elbows to form a 'U' and install at the Type 1S2 0.25 V Pulse Source and the lower Thru Signal Channel 50 Ω connectors. Install a 20 cm airline at the upper Thru Signal Channel 50 Ω connector.

e. Connect a banana plug patch cord from the Type 1S2 Horizontal Output to the Oscilloscope Horiz Input. Normal adjustments of the Horizontal Position control and the Offset (vertical) control are necessary to obtain a display as shown in Fig. 5-9A.

f. Connect a 50 Ω end-line termination to the open end of the 20 cm airline, and change the Vertical Units/Div to .02. Use the Offset control to position the trace to the center of the graticule. Observe a display as in Fig. 5-9B. Note the reflections at the termination point.

g. Remove the 50 Ω end-line termination and connect the Type 284 PULSE OUTPUT connector to the end of the 20 cm airline. Observe the reflections caused by the Type 284 as shown in Fig. 5-9C.

h. Check—Reflections within ± 2.5 divisions ($\pm 5\%$).

i. Disconnect all equipment.

9. Check TRIGGER OUTPUT pulse leadtime before PULSE OUTPUT transition, SN B030236-up

a. Requirement—Trigger leads Pulse by 5 ns or 75 ns, ± 5 ns.

b. Equipment—Sampling Oscilloscope, Type 661, Type 5T3, Type 4S1, BNC to GR adapter and 5 \times attenuator.

c. Set the Sampling Oscilloscope controls as follows:

Type 661	
Horizontal Display	$\times 1$
Position and Vernier	Midrange
Type 5T3	
Equivalent Time/cm	2 ns
Samples/cm	100
Trigger Level	Stable trace
Stability or UHG Sync	Midrange
Trigger Source	Int
Sweep Mode	Norm
Slope	+
Type 4S1	
Millivolts/cm	50
Variable	Calibrated
Mode	Dual-Trace
Vertical Position	Midrange
Display	Normal
DC Offset	Midrange (2 $\frac{1}{2}$ turns from one end)
Smoothing	Normal
Trigger	A, DC

d. Use identical 50 Ω coaxial cables; connect one from the TRIGGER OUTPUT connector with a BNC to GR adapter to the Channel A Input connector and the other from the PULSE OUTPUT connector to the Channel B Input connector.

Performance Check—Type 284

- e. Set the Trig Level control to obtain a stable display.
- f. Check—Trigger leads Pulse by 5 ns \pm 5 ns; see Fig. 5-10A.
- g. Set the Equivalent Time/cm switch to 10 ns and adjust the Time Position control so that the 50% amplitude point of the Trigger waveform is one division from the left graticule edge (trace start).
- h. Set the LEAD TIME switch to 75 ns and observe a display similar to Fig. 5-10C.
- i. Check—Trigger leads Pulse by 75 ns \pm 5 ns (7.5 div, \pm 0.5 div Lead Time).
- j. Use the same setup for the following step.

9. Check TRIGGER OUTPUT pulse leadtime before PULSE OUTPUT transition, SN B010100 through B020235

- a. Requirement—Trigger leads Pulse by 5 ns and 75 ns \pm 5 ns.
- b. Equipment—Sampling Oscilloscope, Type 661, Type 5T3, Type 4S1, BNC to GR adapter and 5 \times attenuator.
- c. Set the Sampling Oscilloscope controls as follows:

Type 661

Horizontal Display \times 1
Position and Vernier Midrange

Type 5T3

Equivalent Time/cm 2 ns
Samples/cm 100
Trigger Level Stable trace
Stability or UHF Sync Midrange
Trigger Source Int
Sweep Mode Norm
Slope +

Type 4S1

Millivolts/cm 50
Variable Calibrated
Mode Dual-Trace
Vertical Position Midrange
Display Normal
DC Offset Midrange (2 $\frac{1}{2}$ turns from one end)
Smoothing Normal
Trigger A, DC

- d. Use identical 50 Ω coaxial cables; connect one from the TRIGGER OUTPUT connector with a BNC to GR adapter to the Channel A Input connector and the other from the PULSE OUTPUT connector to the Channel B Input connector.
- e. Set the Trig Level control to obtain a stable display.
- f. Check—Trigger leads Pulse by 5 ns; see Fig. 5-10A.
- g. Set the Equivalent Time/cm switch to 10 ns and adjust the Time Position control so that the 50% amplitude point of the Trigger waveform is one division from the left graticule edge (trace start).
- h. Set the LEAD TIME switch to 75 ns and observe a display similar to Fig. 5-10C.

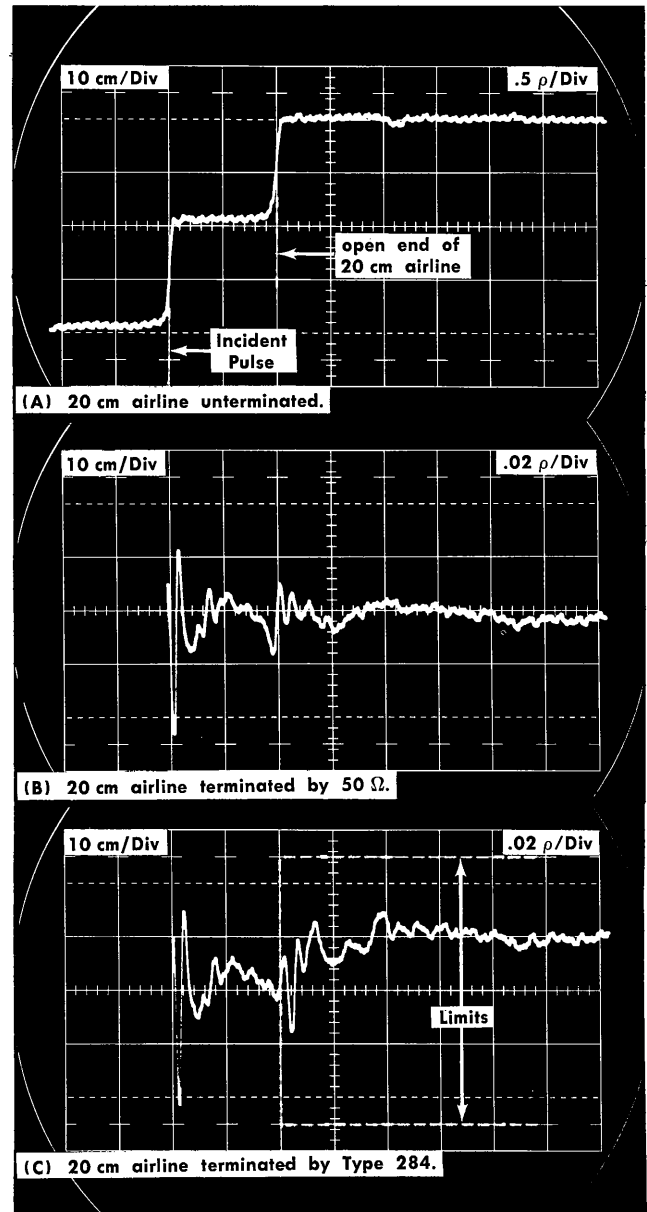

Fig. 5-9. Typical displays showing reflections.

- i. Check—Trigger leads Pulse by 75 ns \pm 5 ns (5 cm \pm 0.5 cm).

- j. Use the same setup for the following step.

10. Check Pre-Trigger Amplitude

- a. Requirement—Pulse Trigger amplitude is 200 mV \pm 20%.
- b. Equipment—Same as preceding step.
- c. Set the Type 4S1 Mode switch to A Only and position the base of the Pulse Trigger waveform to a graticule line and measure the amplitude; see Fig. 5-11A.
- d. Check—Amplitude is 4 cm \pm 0.8 cm or 200 mV \pm 20%.
- e. Use the same setup for the following step.

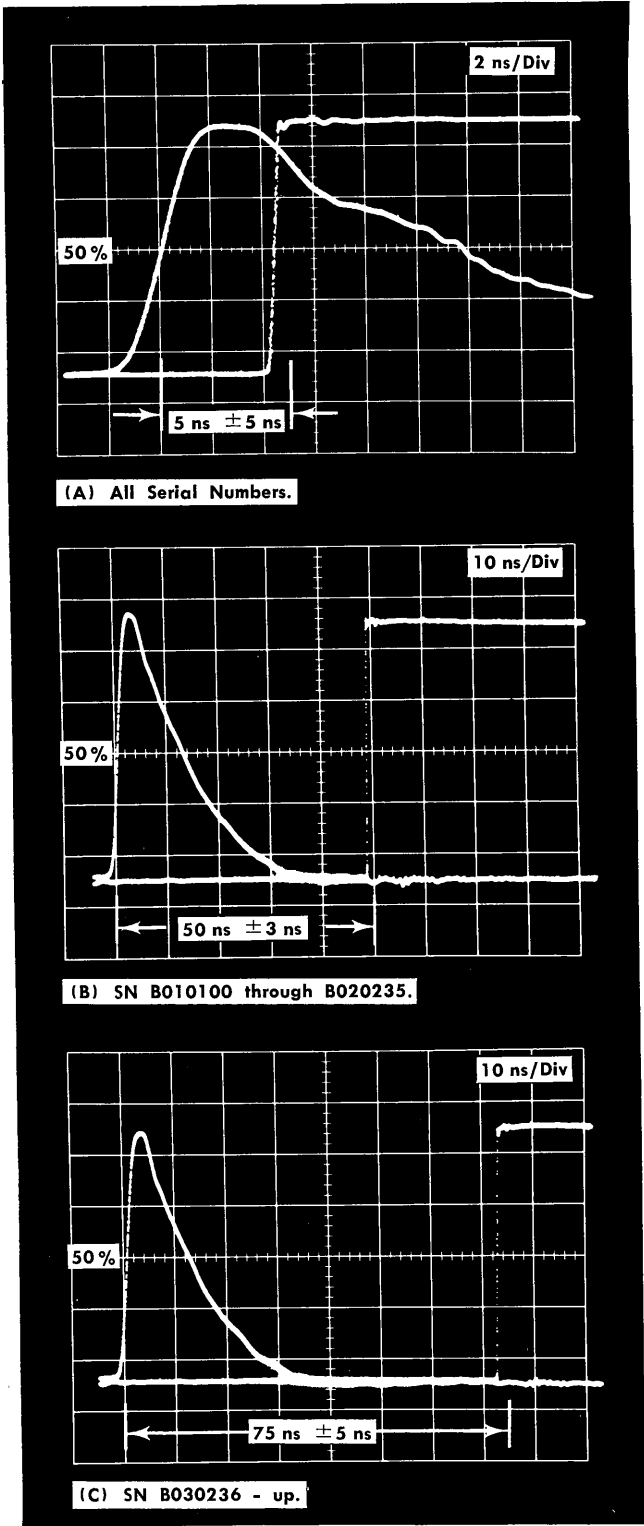

Fig. 5-10. Measurement of Trigger to Pulse time interval.

11. Check Pre-Trigger Pulse Width

- a. Requirement—Pre-trigger pulse width is 10 ns or more.
- b. Equipment—Same as preceding step.

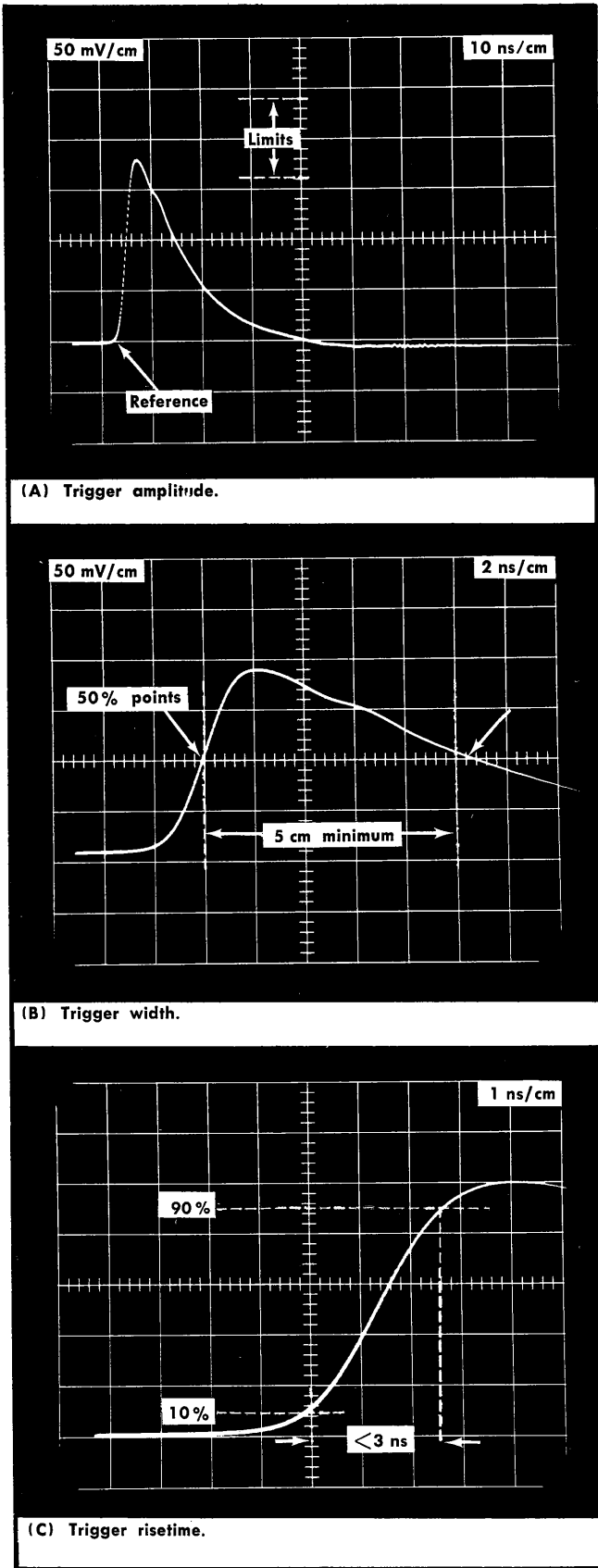

Fig. 5-11. Typical displays used in steps 10, 11 and 12.

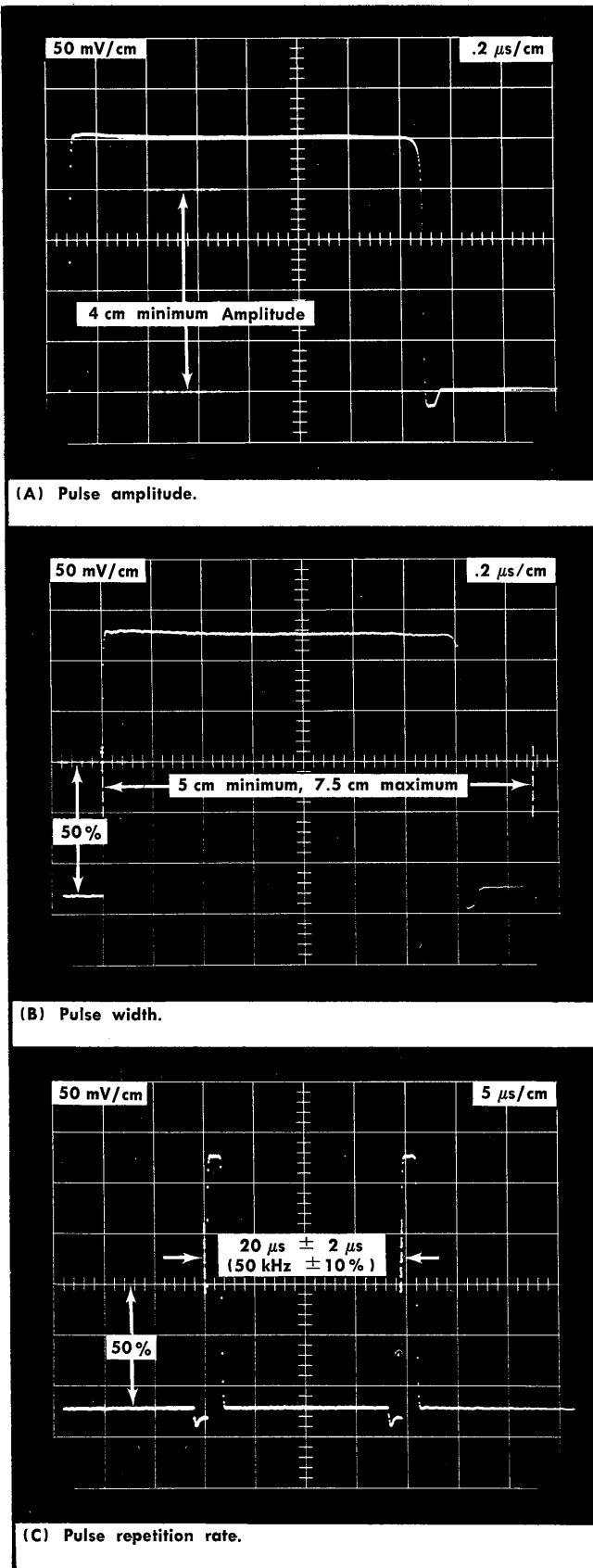

Fig. 5-12. Typical displays used in steps 13, 14 and 15.

c. Set the Type 5T3 Equivalent Time/cm switch to 2 ns and measure the pulse width at the 50% amplitude points; see Fig. 5-11B.

d. Check—Width is 5 cm or more (10 ns or more).

e. Use the same setup for the following step.

12. Check Pre-Trigger Pulse Risetime

a. Requirement—Pre-Trigger pulse risetime is not more than 3 ns.

b. Equipment—Same as preceding step.

c. Set the Type 5T3 Equivalent Time/cm switch to 1 ns.

d. Set the Channel A Variable control for a display amplitude of 5 cm. Measure the risetime between the 10% and 90% points; see Fig. 5-11C.

e. Check—Risetime is 3 cm or less (3 ns or less).

f. Use the same setup for the following step.

13. Check Pulse Amplitude

a. Requirement—Pulse amplitude is 200 mV or more.

b. Equipment—Same as preceding step.

c. Set the Type 4S1 Mode switch to B Only and the Type 5T3 Equivalent Time/cm switch to .2 μ s/cm.

d. Position the base of the waveform at a reference graticule line and measure the amplitude; see Fig. 5-12A.

e. Check—Amplitude is 4 cm or more (200 mV or more).

f. Use the same setup for the following step.

14. Check Pulse Width

a. Requirement—Pulse width is 1 μ s +50%, -0%.

b. Equipment—Same as preceding step.

c. Set the Equivalent Time/cm switch to the 2 μ s position, pull the Magnifier and set to the .2 μ s position. The Time Position range is 100 μ s.

d. Change the Time Position control counterclockwise to position the Pulse display at the center of the screen; see Fig. 5-12B. Measure the Pulse width at the 50% amplitude points.

e. Check—Pulse width is 5 cm, not more than 7.5 cm (1 μ s +50% -0%).

f. Use the same setup for the following step.

15. Check Pulse Repetition Rate

a. Requirement—Pulse repetition rate is 50 kHz \pm 10%.

b. Equipment—Same as preceding step.

c. Set the Equivalent Time/cm switch to .5 μ s calibrated, and set the Time Position control to obtain a two-pulse display; see Fig. 5-12. Measure the time between positive-going portions of the pulses.

d. Check—Time is $20 \mu\text{s} \pm 2 \mu\text{s}$ ($4 \text{ cm} \pm 0.4 \text{ cm}$), $50 \text{ kHz} \pm 10\%$.

e. Disconnect the cables.

16. Check Pulse Risetime

a. Requirement—Pulse risetime is 70 ps or less.

b. Equipment—Type 661, Type 5T3, Type 4S2A, 20 cm airline, $5\times$ attenuator and GR to BNC adapter.

c. Set the Sampling Oscilloscope controls as follows:

Type 661

Horizontal Display	$\times 1$
Position and Vernier	Midrange

Type 5T3

Samples/cm	50
Equivalent Time/cm	50 ps, Calibrated
Trigger Level	Midrange
Stability or UHF Sync	Midrange
Sweep Mode	Norm
External Trigger Mode	50Ω AC
Trigger Source	Ext

Type 4S2A

Millivolts/cm	100
Variable	For indicated display
Mode	A Only
Vertical Position	Midrange
DC Offset	Midrange (2.5 turns from one end)
Smoothing	Unity dot response

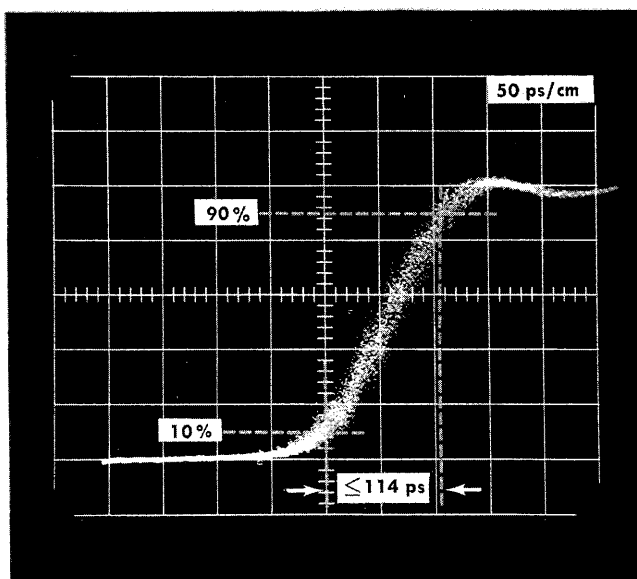

Fig. 5-13. Typical display showing risetime.

d. Connect a 20 cm airline from the Type 284 PULSE OUTPUT connector to the Channel A Input connector. Set the Type 284 LEADTIME switch to 75 ns.

e. Connect a coaxial cable from the TRIGGER OUTPUT connector to a GR to BNC adapter and $5\times$ attenuator to the 50Ω Trigger Input.

f. Set the Trigger Level control for a stable display and the Time Position control to center the display.

g. Set the Millivolts/cm Variable control so the display amplitude is 5 cm. Measure the risetime of the pulse from the 10% to 90% points; see Fig. 5-13.

h. Check—Observed risetime is 114 ps or less (2.3 cm or less). This is an approximation based on the following equation for actual risetime when applied pulse risetime approaches that of the system risetime:

$$T_r \text{ measured} = (T_r \text{ pulse applied})^2 + (T_r \text{ system})^2$$

$$T_r \text{ applied} = 70 \text{ ps or less (Type 284)}$$

$$T_r \text{ system} = 90 \text{ ps or less (Type 4S2A)}$$

i. Use the same setup for the following step.

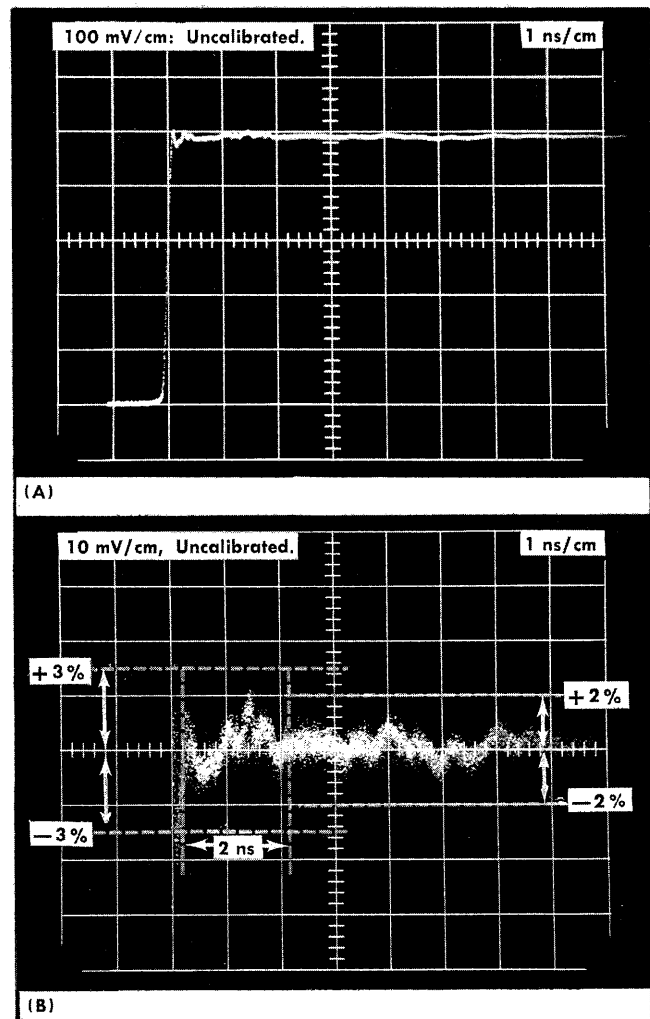

Fig. 5-14. Typical display of flatness deviation check using Type 4S2A Vertical Sampling Unit.

Performance Check—Type 284

17. Check Pulse Flatness Deviation

a. Requirement—During first 2 ns after pulse reaches 100% amplitude: $\leq 3\%$ p-p total deviation over a range from +3% to -3%. After 2 ns: $\leq 2\%$ p-p total deviation over a range from +2% to -2%.

b. Equipment—Same as preceding step.

c. Set the Equivalent Time/cm switch to 1 ns and set the Trigger Level and Time Position controls for a stable display.

d. Set the Millivolts/cm switch to 100 and set the Variable control for a 5 cm display similar to Fig. 5-14A.

e. Change the Millivolts/cm control to 10 (increase amplitude by 10 times) and position the trace to observe the

upper portion of the trace at the center of the graticule as shown in Fig. 5-14B.

f. Check—Pulse flatness deviation in the first 2 cm (2 ns) of the Pulse display is ≤ 1.5 cm (3%) p-p total over a range from +1.5 cm to -1.5 cm; after 2 cm, deviation is ≤ 1 cm (2%) p-p total over a range from +1 cm to -1 cm.

This requirement is applied to the Type 284 only and does not apply to the Type 4S2A or other vertical sampling unit. If the aberrations exceed the limits, evaluate the vertical sampling unit aberrations and subtract that value from the measured value to determine the Type 284 aberrations.

This completes the performance check procedure for the Type 284 Pulse Generator. If the instrument has met all performance requirements given in this procedure, it is correctly calibrated and within the specified tolerances.

SECTION 6

CALIBRATION

Change information, if any, affecting this section will be found at the rear of the manual.

Introduction

This calibration procedure can be used for a complete calibration of the Type 284 to return it to the original performance limits stated in Section 1 of this manual. Completion of every step in this procedure returns the Type 284 to original factor performance standards.

General Information

Performance and/or calibration of the Type 284 should be checked after each 1000 hours of operation and at least once every 6 months to assure that the instrument is operating correctly and accurately. Recalibration of the instrument may be performed periodically as part of a regular preventive maintenance schedule or may be done whenever the need is indicated by the performance check procedure. In addition, portions of the instrument will require recalibration if components have been replaced or other electrical repairs have been made in the circuitry.

The step by step instructions of the procedure furnish an orderly approach to recalibration and also serve as an aid in troubleshooting and repairing the instrument. Any maintenance that is known to be needed should be performed before starting the calibration procedure. If any troubles become apparent during recalibration, they should be corrected before proceeding. Repair and servicing information is given in the Maintenance section of this Manual.

EQUIPMENT REQUIRED

The following (or equivalent) items of equipment are required for a complete calibration of the Type 284. The equipment is illustrated in Fig. 6-1 and 6-2. If substitute equipment is used, it must equal or exceed the stated requirements in order to calibrate the Type 284 to the limits stated in Section 1. If substituted equipment does not meet the stated requirements, the difference between the accuracy of the equipment used and the accuracy of the equipment listed must be added to the tolerance stated in the calibration step.

1. Line voltage autotransformer with output voltage variable between 90 and 136 (or 180 and 272) volts and a minimum rating of 10 watts. If autotransformer does not have an RMS voltmeter to indicate output voltage, monitor the output with a separate RMS reading voltmeter with a range of at least 136 (272) volts. For example, General Radio W10MT3W Metered Variac Autotransformer.

2. A precision, non-loading DC voltmeter with the following minimum tolerances: $\pm 0.1\%$ at 20 volts, $\pm 0.05\%$ at 1 volt, $\pm 0.1\%$ at 100 mV and $\pm 0.15\%$ at 10 mV. A John Fluke Model 801B voltmeter meets these requirements.

3. Test oscilloscope with at least 10 MHz bandwidth with a sensitivity of 50 mV/cm (except for 1 mV sensitivity for ripple check), added inputs, and an accuracy of within 3%. Tektronix Type 545B Oscilloscope and Type 1A1 Plug-In Unit recommended.

4. Spectrum analyzer plug-in unit with frequency coverage 100 MHz and 1 GHz with calibrated dispersion of .5 and 5 MHz/cm $\pm 10\%$. Tektronix Type 1L20 Multi-Band Spectrum Analyzer Plug-In Unit recommended (for frequency measurements).

5. Reflectometer for Time-Domain Reflectometry measurements with a vertical deflection of $0.02 \rho \pm 3\%$, and a horizontal deflection of 10 cm/division $\pm 3\%$. Tektronix Type 1S2 Sampling Unit recommended.

6. Time mark generator, with marker or sine wave outputs of 10 μ s, 1 μ s, 100 ns, 10 ns and 2 ns with an accuracy of 0.005%. Tektronix Type 184 Time Mark Generator recommended.

7. Sampling oscilloscope. Dual trace, risetime 350 ps. Tektronix Type 661 with Type 4S1 and Type 5T3 Plug-In Units recommended.

8. Sampling Plug-In Unit, risetime minimum of 90 ps. Tektronix Type 4S2A recommended. Type 1S2 could be substituted.

9. Sampling Plug-In Unit, Input RC of 100 k Ω paralleled by 2 pF. Tektronix Type 4S3. Type 3S3 could be substituted with Type 560-series Oscilloscope and sampling time base (use in step 8).

10. 1 \times probe with BNC connector, such as Tektronix P6011, Part No. 010-0193-00.

11. Two 50 Ω coaxial cables, 42 inch length, type RG58U with BNC connectors. Tektronix Part No. 012-0057-01.

12. One 50 Ω coaxial cable, 20 inch length, type RG58U with BNC connectors. Tektronix Part No. 012-0076-00.

13. Two 50 Ω coaxial cables, 5 ns signal delay, type RG213U with GR connectors. Tektronix Part No. 017-0502-00.

14. Patch cord, length about 18 inches, with banana plugs. Tektronix Part No. 012-0031-00.

15. One 50 Ω 10 \times Attenuator, GR 874-G20. Tektronix Part No. 017-0078-00.

16. One 50 Ω 5 \times Attenuator, GR 874-G14. Tektronix Part No. 017-0079-00.

17. One 50 Ω 2 \times Attenuator, GR 874-G6. Tektronix Part No. 017-0080-00.

18. One coaxial adapter, GR to BNC female. Tektronix Part No. 017-0063-00.

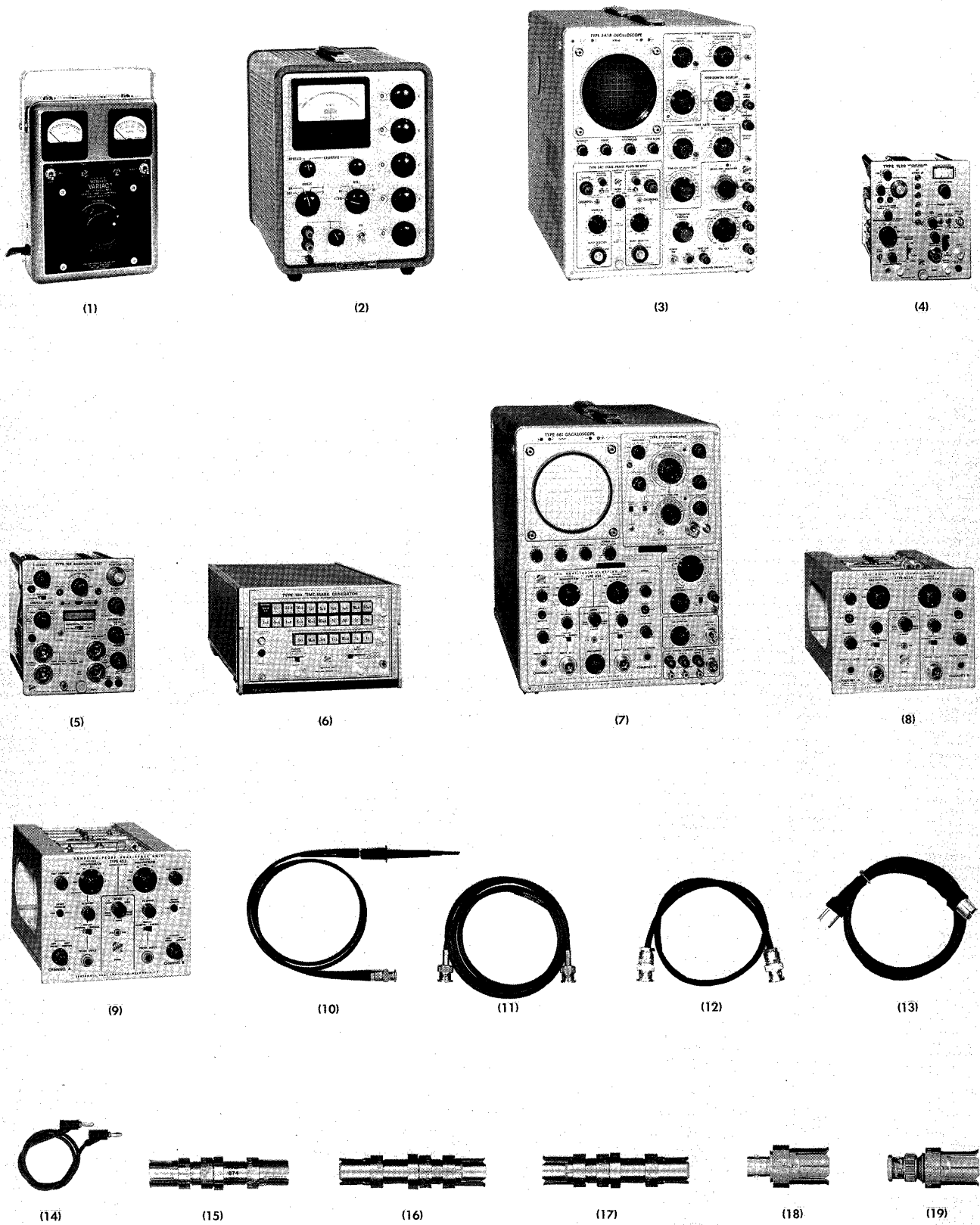

Fig. 6-1. Equipment required for calibration.

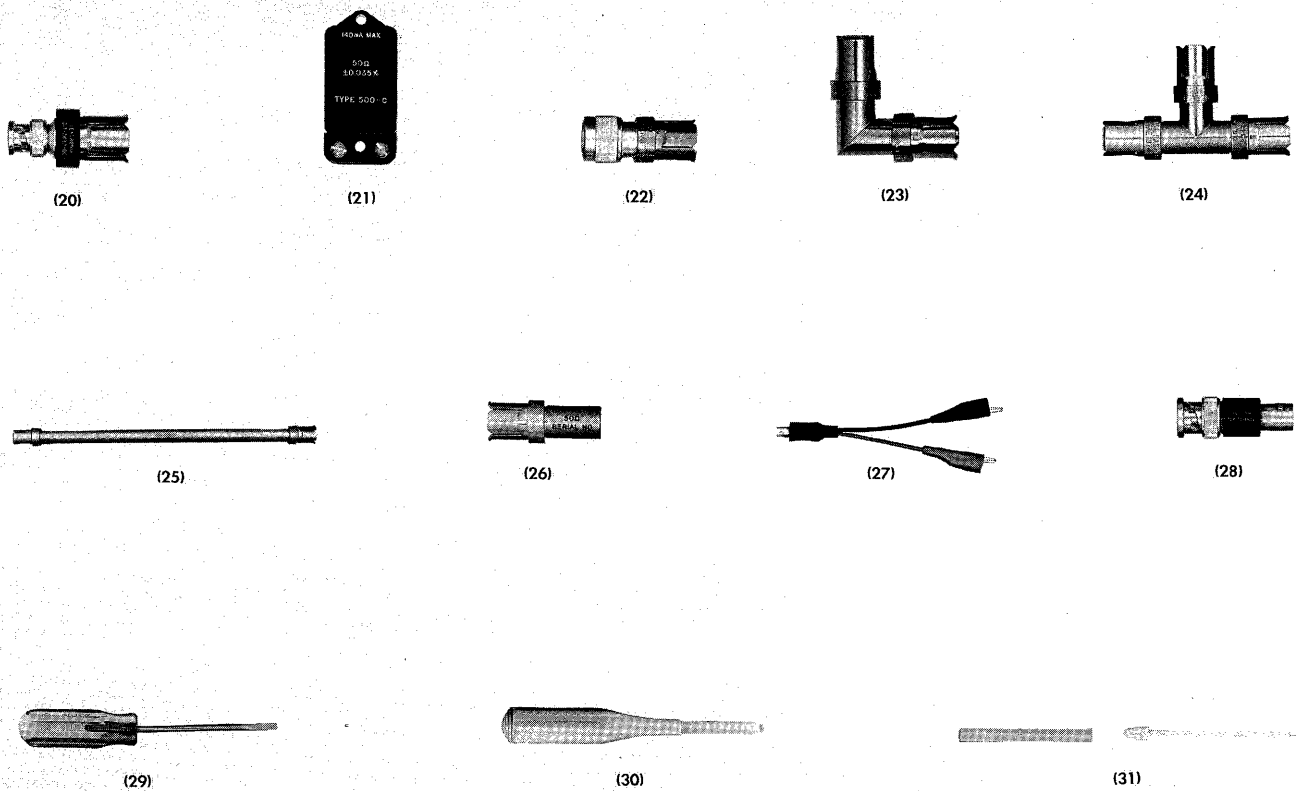

Fig. 6-2. Equipment and adjustment tools required for calibration.

19. One coaxial adapter, GR to BNC male. Tektronix Part No. 017-0064-00.

20. One 50 Ω Thru-line Termination with GR to BNC male connectors. Tektronix Part No. 017-0083-00.

21. 50 Ω precision resistor, $\pm 0.05\%$. General Radio Type 500-C, meets this requirement.

22. One coaxial adapter, GR to N male. Tektronix Part No. 017-0021-00.

23. Two 90° coaxial Elbows for use with Type 1S2, GR 874-EL. Tektronix Part No. 017-0070-00.

24. One coaxial tee connector, GR 874-T. Tektronix Part No. 017-0069-00.

25. One 20 cm Airline, GR 874-L20. Tektronix Part No. 017-0084-00.

26. One 50 Ω end-line termination, $\pm 0.5\%$ GR 874-W50B. Tektronix Part No. 017-0081-00.

27. One Clip lead adapter, BNC used in step 4. Tektronix Part No. 013-0076-00.

28. One 50 Ω Termination $\pm 2\%$ with BNC connectors. Tektronix Part No. 011-0049-00.

29. Pocket screwdriver with shank at least 2 inches long and a blade width of approximately $\frac{3}{32}$ inch. Tektronix Part No. 003-0192-00.

30. Insulated screwdriver with a $1\frac{1}{2}$ -inch plastic shank for adjusting potentiometers and capacitors. Jaco No. 125 or Tektronix Part No. 003-0000-00. Preferred non-metallic tip type for capacitor adjustments.

31. Plastic tool for adjusting small-core variable inductors, $\frac{5}{32}$ -inch hex, such as the combination of Tektronix Part Nos. 003-0307-00 and 003-0310-00.

CALIBRATION RECORD AND INDEX

This Abridged Calibration Procedure is provided to aid in recording the recalibration of the Type 284. It may be used as a calibrating guide by the experienced calibrator, or it may be used as a calibration record. Since the step numbers and titles used here correspond to those used in the complete Calibration Procedure, the following procedure serves as an index to locate a step in the complete Calibration Procedure.

Type 284 Serial No. _____

Calibration Date _____

- 1. Check or Adjust +20-Volt Power Supply (Page 6-5)
Meter reading of +20 volts, ± 0.2 volt. Value: _____.
- 2. Check -20-Volt Power Supply (Page 6-5)
Meter reading of -20 volts, ± 0.6 volt. Value: _____.
- 3. Check Power Supply Regulation and Ripple (Page 6-5)
Maximum ripple of 2 mV. Ripple: _____.
- 4. Adjust Square Wave Amplitude (Page 6-7)
Meter reading of 1 volt ± 5 mV at 1 V setting; see Calibration Procedure for other tolerances.
- 5. Adjust 100 ns Drive L21 (Page 6-9)
- 6. Adjust Square Wave Symmetry (Page 6-9)
Midpoint of cycle is within 48% to 52%.
- 7. Adjust Square Wave Timing (Page 6-12)
Timing within $\pm 0.5\%$ at 100 μ s and 1 μ s; within $\pm 0.05\%$ at 100 ns.
- 8. Check Square Wave Trigger Amplitude (Page 6-12)
Amplitude 200 mV ± 40 mV. Value: _____.
- 9. Adjust 10 ns Sine Wave Period C62 (Page 6-13)
10 ns period $\pm 1\%$ or 100 MHz ± 1 MHz.
- 10. Adjust 1 ns Sine Wave Period C73 (Page 6-15)
1 ns period $\pm 1\%$ or 1 GHz ± 10 MHz.
- 11. Adjust 10 ns Period Amplitude C66 (Page 6-16)
Amplitude 100 mV $\pm 20\%$. Value: _____.
- 12. Adjust 1 ns Period Amplitude C72 (Page 6-16)
Amplitude 100 mV $\pm 20\%$.
- 13. Check Sine Wave Trigger Amplitude (Page 6-17)
Amplitude 200 mV $\pm 40\%$. Value: _____.
- 14. Check Reflections from Pulse Generator (Page 6-19)
Reflections $\pm 5\%$. Value: _____.
- 15. Adjust TD BIAS (front panel) (Page 6-20)
Diode starts conduction with clockwise TD BIAS rotation.

- 16. Adjust Bias Balance R123 (Page 6-21)
Base line of square wave is at zero volt reference.
- 17. Adjust Snap-Off Current R174 (Page 6-21)
5 ns between Trigger and Pulse displays.
- 18. Check Lead Time 75 ns (Page 6-21)
75 ns ± 5 ns between the Trigger and Pulse displays.
- 19. Check Pulse Trigger Amplitude (Page 6-22)
Amplitude 200 mV $\pm 20\%$. Value: _____.
- 20. Check Pulse Trigger Width (Page 6-22)
Width 10 ns or more. Value: _____.
- 21. Check Pulse Trigger Risetime (Page 6-22)
Risetime 3 ns or less. Value: _____.
- 22. Check Pulse Amplitude (Page 6-22)
Amplitude 200 mV or more. Value: _____.
- 23. Check Pulse Width (Page 6-22)
Pulse width 1 μ s, +50% -0%. Value: _____.
- 24. Check Pulse Repetition Rate (Page 6-22)
Repetition rate 50 kHz $\pm 10\%$. Value: _____.
- 25. Check Pulse Risetime (Page 6-24)
Risetime 70 ps or less. Value: _____.
- 26. Check Pulse Flatness Deviation (Page 6-32)
 $\leq 3\%$ p-p total deviation over a range from +3% to -3%. After 2 ns: $\leq 2\%$ p-p total deviation over a range from +2% to -2%.

CALIBRATION PROCEDURE

General

In the procedure that follows, test equipment setups are illustrated at major setup changes. Control settings for the Type 284 and associated instruments are given under the setup pictures. Control settings changes from the preceding step are indicated in bold-face type.

NOTE

Changing the +20 volt power supply voltage makes it necessary to perform the complete calibration procedure.

Preliminary Procedure

- a. Check all front-panel controls for proper indexing, smooth operation and correct any defects found.
- b. Remove the Type 284 from the case.
- c. Connect the Type 284 power cord to the output of the line voltage variable autotransformer, set for an output of 115 volts (230 volts).
- d. Turn on all test equipment.

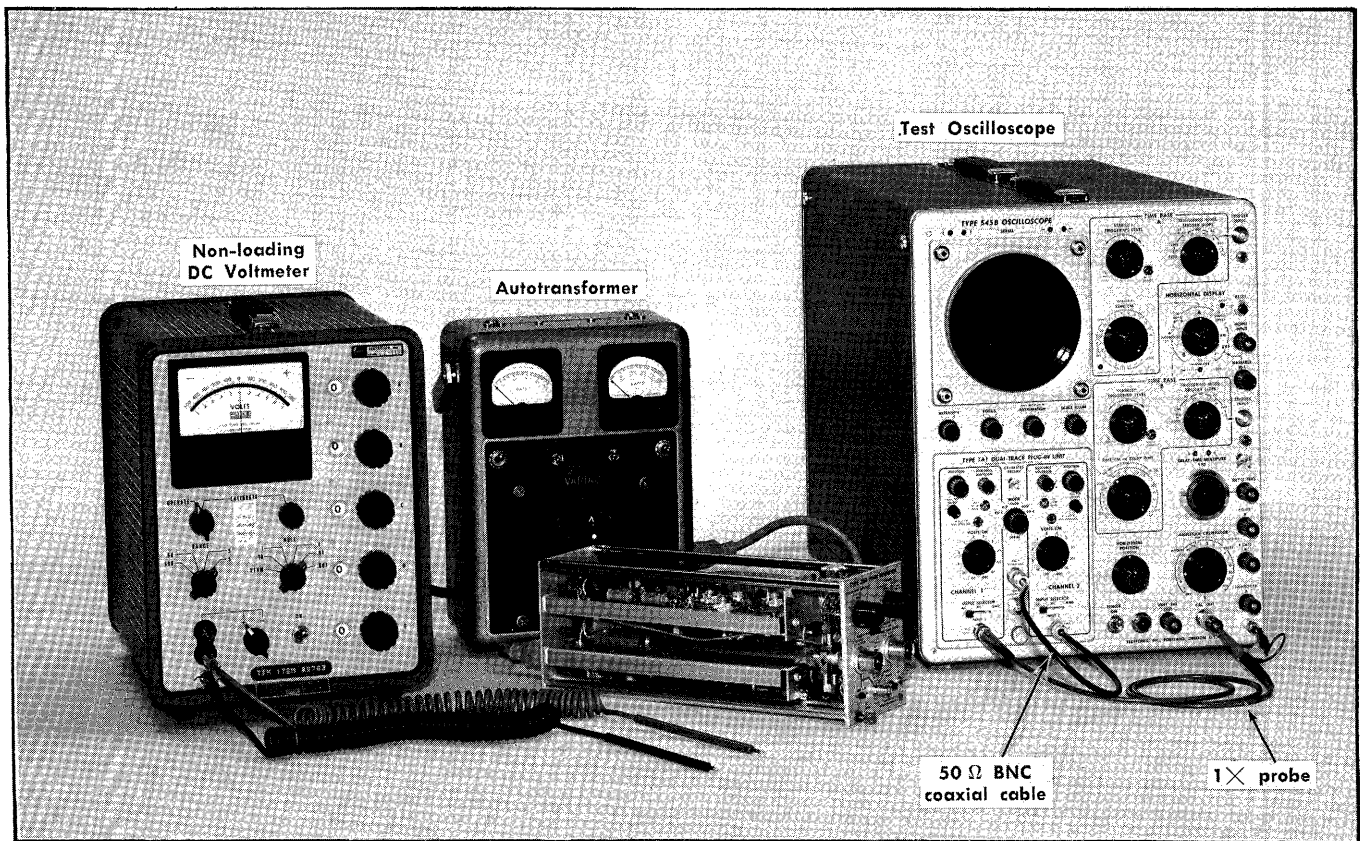

Fig. 6-3. Equipment setup for power supply checks, steps 1 through 3.

Control settings

	Type 284	
SQUARE WAVE AMPLITUDE		10 mV
PERIOD		10 ns
MODE		SQUARE WAVE OR SINE WAVE OUTPUT

Test Oscilloscope Type 545B with Type 1A1

Channel 1 Volts/cm	.005
Mode	CH 2
Channel 2 Volts/cm	.01
Input Selectors (both channels)	AC
Amplitude Calibrator	1 mVolt

Precision Nonloading DC Voltmeter

Set controls to measure the correct value and polarity of voltage in the steps that follow before connecting the test leads to the test points.

Connections

Connect a short BNC coaxial cable from the Type 1A1 CH 1 Signal Out connector to the Input 2 connector. Connect the 1X probe to the Input 1 connector and attach the probe tip to the oscilloscope Cal Out connector through a

binding post adapter. Check the oscilloscope display for 1 cm amplitude.

1. Check or Adjust +20-Volt Power Supply

a. Use the equipment setup shown in Fig. 6-3, and connect the nonloading DC voltmeter between +20 V, TP226, and ground, TP266. The power supply voltage test points and controls are shown in Fig. 6-4.

b. Check—Meter reading; +20 volts, ± 0.2 volts. If the voltage is higher than +20.2, or less than +19.8 volts, adjust R227, the +20 VOLT control, for +20 volts.

2. Check -20-Volt Power Supply

a. Connect the nonloading DC voltmeter between -20 V, TP262, and ground, TP226, shown in Fig. 6-4.

b. Check—Meter reading; -20 volts, ± 0.6 volts. Check that the voltage is between -19.4 and -20.6 volts.

3. Check Power Supply Regulation and Ripple

a. Equipment setup is shown in Fig. 6-3.

b. Connect the test oscilloscope 1X probe tip to TP226, and attach the probe ground clip to TP266. See Fig. 6-4 for their location.

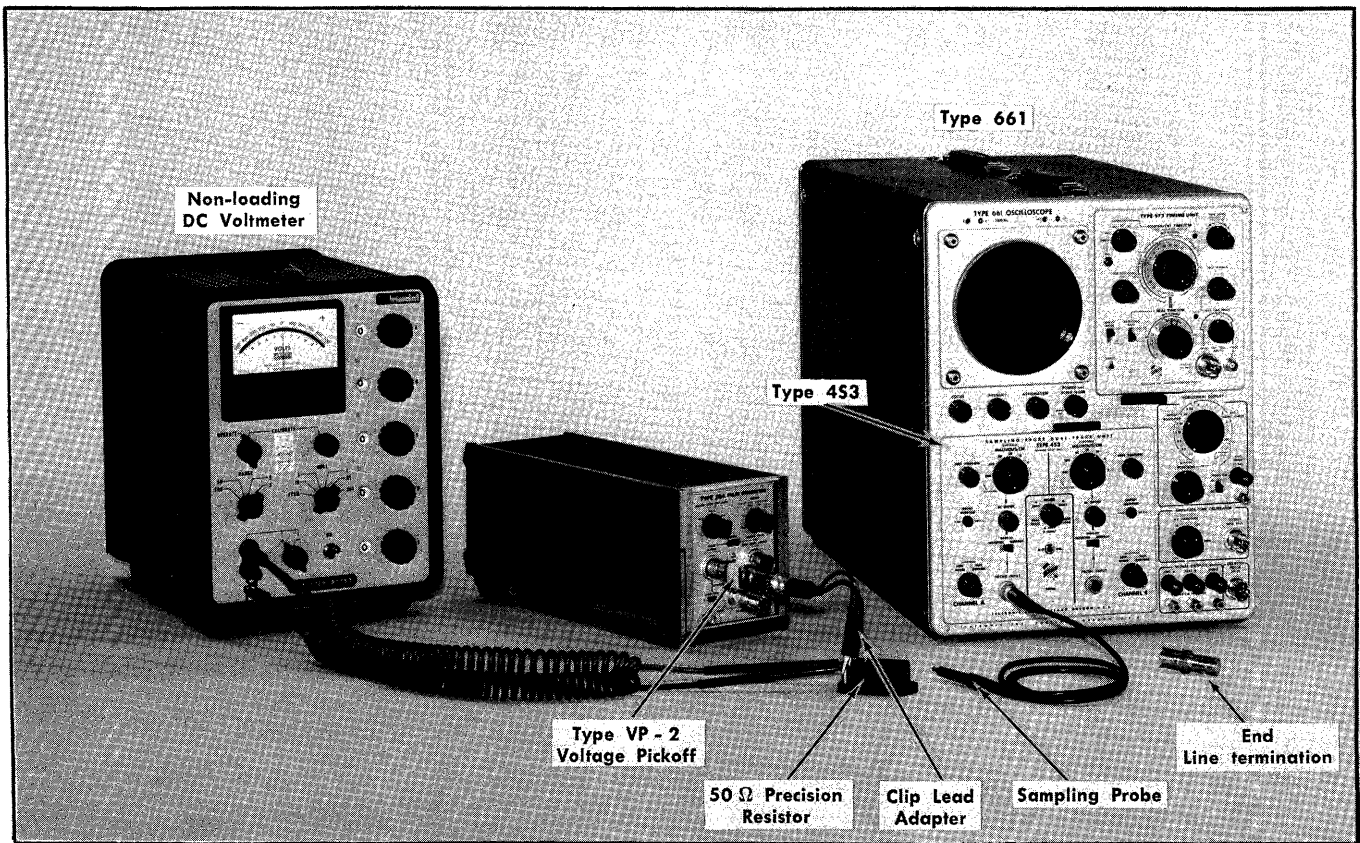

Fig. 6-6. Initial setup of test equipment used in step 4.

Control settings

	Type 284	
SQUARE WAVE AMPLITUDE	1.0 V	
PERIOD	10 μs	
MODE	SQUARE WAVE OR SINE WAVE OUTPUT	

	Type 661
Horizontal Display Position and Vernier	$\times 1$ Midrange

	Type 453
Millivolts/cm	20
Millivolts/cm Variable Mode	Calibrated A Only
Vertical Position	Midrange
DC Offset	Midrange
Display Smoothing	Normal
Low Noise-Fast Risetime	Adjusted to unit loop gain (about 45° from clockwise position) Fast Risetime

	Type 5T3
Equivalent Time/cm	1 μ s
Equivalent Time/cm Variable	Cal

Equivalent Time Samples/cm	100
Time Position	clockwise
Time Position Fine	clockwise
Sweep Mode	Norm
Trigger Level	Midrange
Stability or UHF Sync	Midrange
Trig Source	Free Run
Slope	—
Ext Trig Mode	50 Ω AC

4. Adjust Square Wave Amplitude, R51 ①

- a. Use equipment setup shown in Fig. 6-6.
- b. Connect the 50 Ω resistor, (item 21 on equipment required list) by a BNC clip lead adapter through a BNC to GR adapter and a voltage pickoff VP-2 to the SQUARE WAVE OR SINE WAVE OUTPUT connector on the Type 284. Connect the precision voltmeter (item 2 in equipment list) across the resistor. If you use a precision resistor with a single coaxial connector a Tee connector can be used.
- c. Remove Q35 from its socket (see Fig. 6-7 for location).
- d. Adjust the Square Wave Amplitude control R51 to exactly one volt as read on the most sensitive null range of the precision voltmeter.
- e. Change the SQUARE WAVE AMPLITUDE switch to 100 mV, and check that the voltage is 100 mV \pm 1 mV.

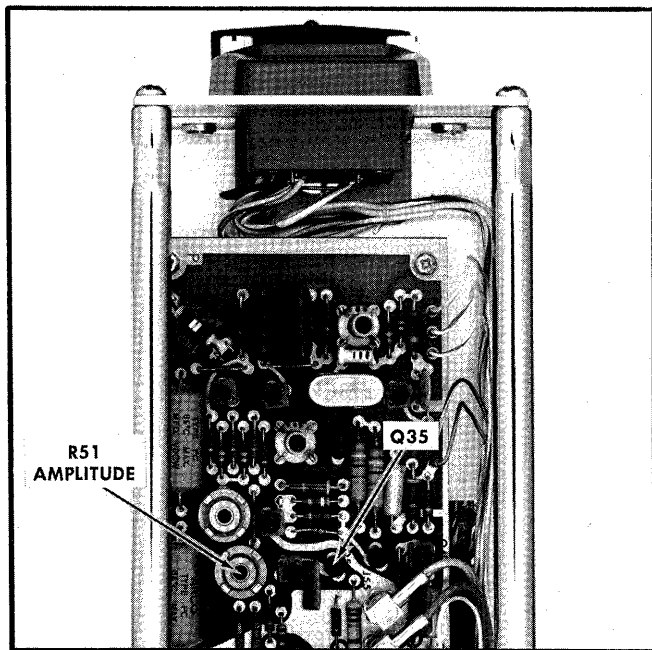

Fig. 6-7. Locations of adjustments in step 4.

f. Change the SQUARE WAVE AMPLITUDE switch to 10 mV, and check that the voltage is 10 mV \pm 0.15 mV.

g. If the 100 mV or the 10 mV readings are in error by more than the tolerances given, readjust slightly R51 so they are in tolerance and then recheck the 1 volt reading to be within \pm 5 mV.

h. Disconnect the Voltmeter from the resistor, and place the P6038 Probe tip (from channel A of the Type 4S3) into the voltage pickoff VP-2.

i. Change the DC Offset counterclockwise, and the Position control to position the 1 V DC trace to the center of the graticule. Do not change this control after it is set so a voltage comparison can be made.

j. Return Q35 to its socket. Connect the Trigger Output signal from the Type 284 TRIGGER OUTPUT connector

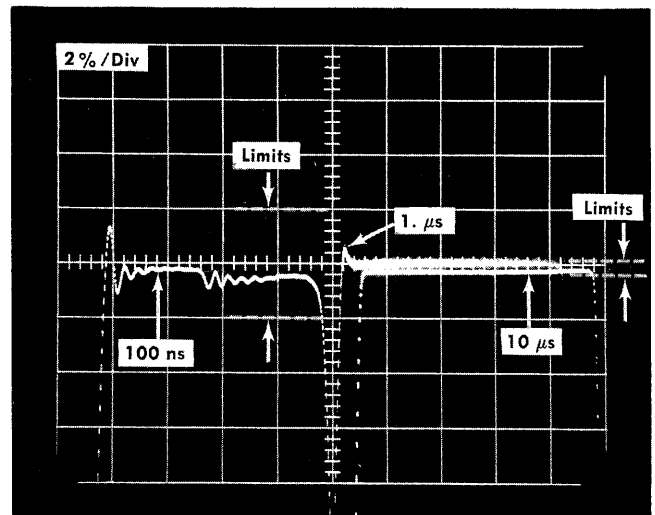

Fig. 6-8. Typical display showing Amplitude checks at 3 time periods (triple exposure).

through a BNC to GR adapter and a 5 ns 50 Ω coaxial cable to the Ext Trig Input connector on the Type 5T3.

k. Change the Trig Source to EXT.

l. Adjust the Trigger Level control for a stable trace, and observe the upper portion of the square wave within \pm 5 mV of the center of the graticule. This vertical position was set up in step (i).

m. Change the PERIOD switch on the Type 284 to 1 μ s, and change the Equivalent Time/cm to .1 μ s/cm on the Type 5T3. Observe the upper portion of the waveform as in step (l) to be within \pm 5 mV of the center of the graticule.

n. Remove the Precision resistor, clip lead adapter, and BNC to GR adapter from the VP-2, and connect the 50 Ω End-line Termination to the VP-2.

o. Change the PERIOD switch on the Type 284 to 100 ns, and change the Equivalent Time/cm on the Type 5T3 to 10 ns/cm. Observe the upper portion of the displayed square wave to be within 20 mV after the first 20 ns. See Fig. 6-8.

NOTES

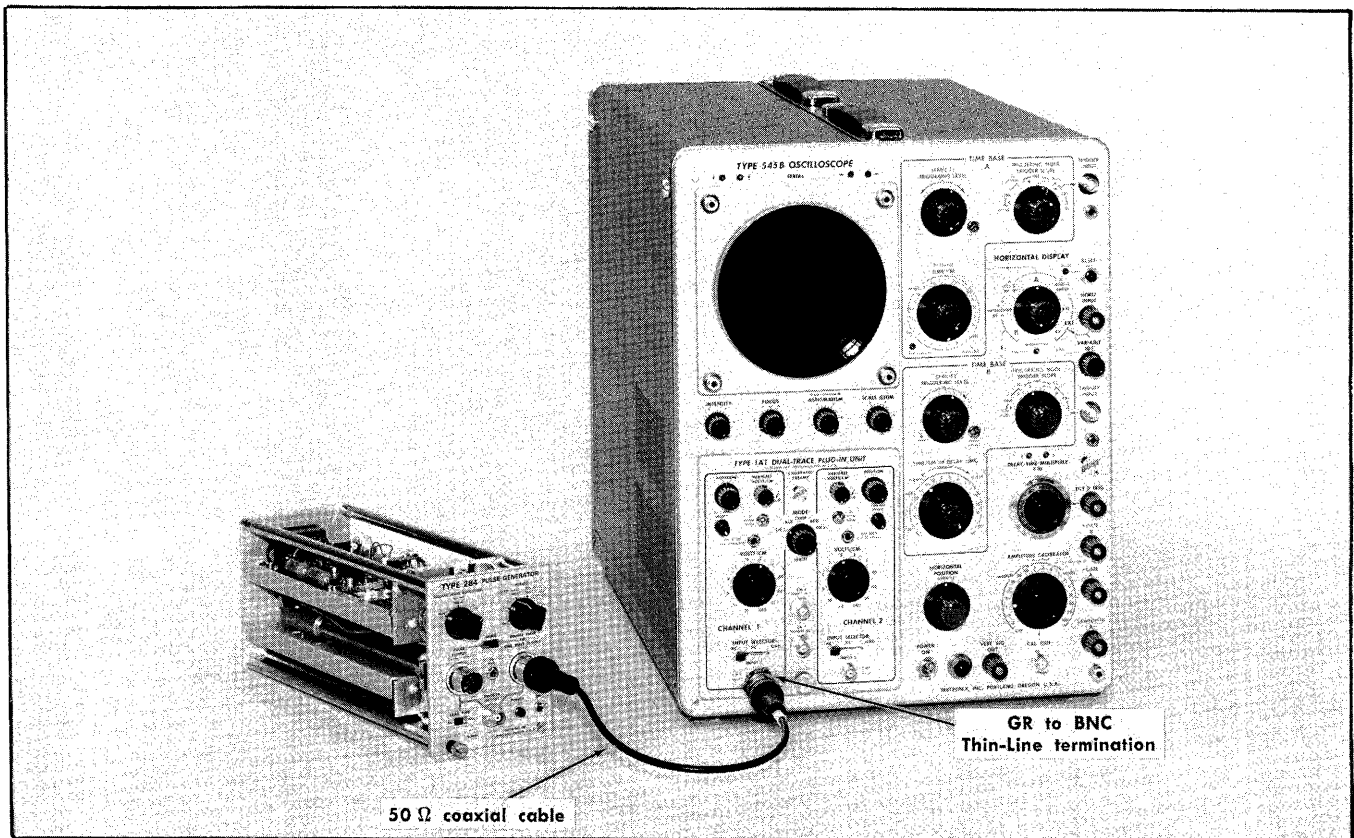

Fig. 6-9. Equipment setup for steps 5 and 6.

Control settings

	Type 284
SQUARE WAVE AMPLITUDE	1.0 V
PERIOD MODE	100 ns SQUARE WAVE OR SINE WAVE OUTPUT
LEAD TIME	5 ns

Test Oscilloscope with Type 1A1

Triggering	—Int, AC
Time/cm	.1 μ s
Variable Time/cm	Calibrated
Mode	CH 1
Volts/cm	.2
Input Selector	AC

Connections

Connect the SQUARE WAVE OR SINE WAVE OUTPUT connector to the test oscilloscope Input 1 connector. Use a 50 Ω coaxial cable and a 50 Ω thru-line GR to BNC termination (item 20 equipment required).

5. Adjust 100 ns Drive, L21 ❶

a. Use the equipment setup shown in Fig. 6-9. Obtain a stable display of the 100 ns period 10 MHz square wave signal on the test oscilloscope.

b. Use a plastic tool, item 31 on the equipment required list, and rotate L21 core slug (see Fig. 6-10 for its location) counterclockwise toward minimum inductance until the oscillations stop. Then rotate the L21 core slug clockwise toward increasing inductance until oscillations start. Rotate the core one turn clockwise and leave it.

6. Adjust Square Wave Symmetry ❶

a. Set the PERIOD switch on the Type 284 to 10 μ s, and the Test Oscilloscope Time/cm switch to 1 μ s.

b. Adjust the Variable Time/cm control, the vertical position control, and the Triggering controls to obtain a display of one complete cycle over the center 8 cm of the graticule, as shown in Fig. 6-11.

c. Adjust the Duty Factor control, R31 (see Fig. 6-10 for its location) so that the half cycle point of the display, measured at 50% amplitude, is at the graticule center vertical line, showing that this point is 50% of the full cycle time.

d. Set the Type 284 PERIOD switch to 1 μ s, and the Test Oscilloscope Time/cm to .1 μ s/cm.

e. Obtain a display similar to Fig. 6-11, and check that the midpoint of the cycle is within ± 0.16 cm of the graticule center vertical line, measured at the 50% amplitude point; showing that the midpoint is between 48% and 52% of one cycle.

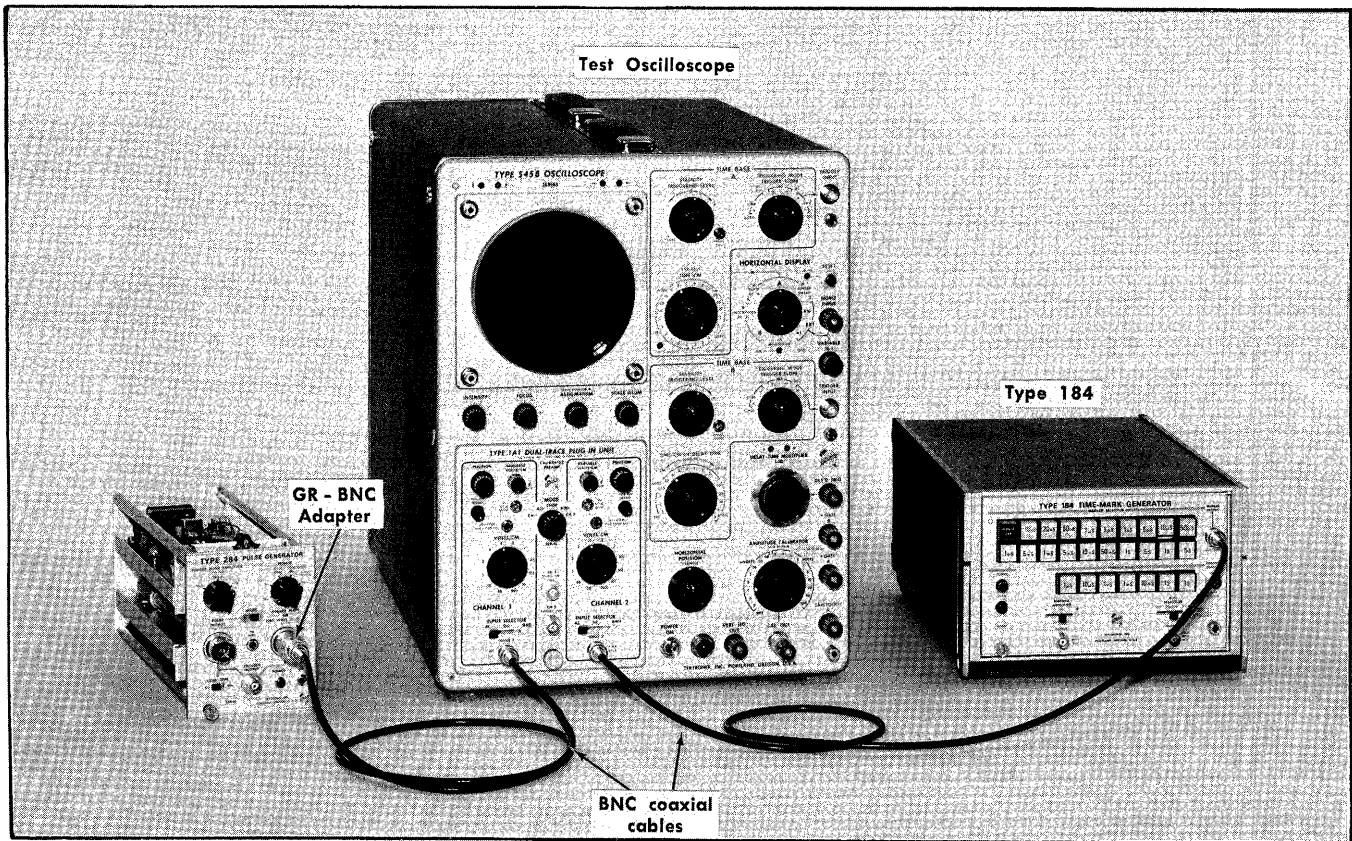

Fig. 6-12. Equipment setup for steps 7 and 8.

Control settings

	Type 284
SQUARE WAVE AMPLITUDE	1.0 V
PERIOD	10 μ s
MODE	SQUARE WAVE OR SINE WAVE OUTPUT

Test Oscilloscope—Type 545B with Type 1A1

Triggering	+Int, AC
Time/cm	2 ms
Channel 1 Volts/cm	.5
Mode	Add
Channel 2 Volts/cm	.5
Input Selectors (both channels)	AC

Type 184

Marker selector	10 μ s
-----------------	------------

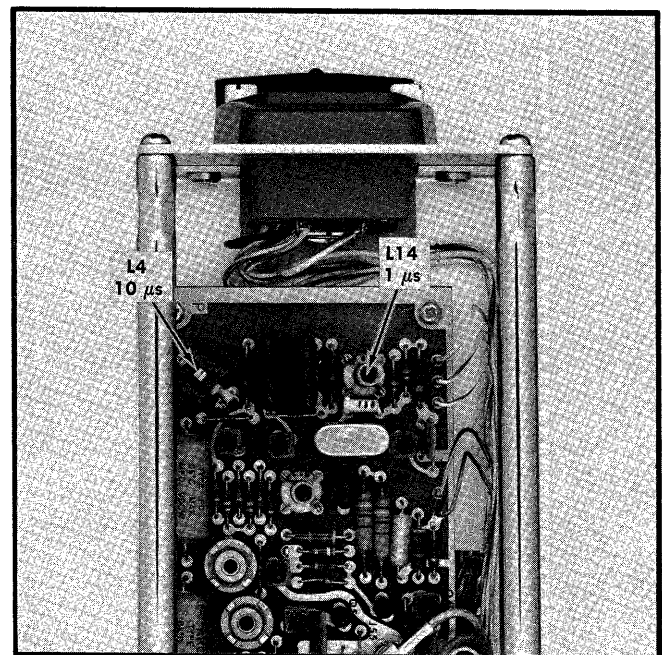

Fig. 6-13. Locations of Square Wave Timing, step 7.

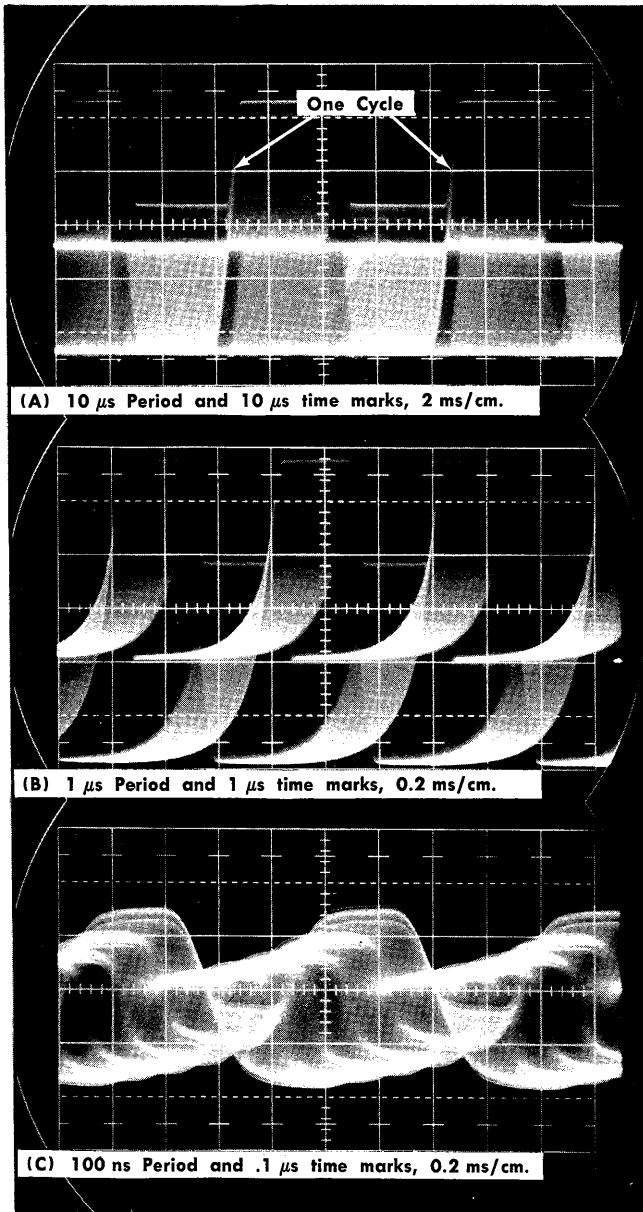

Fig. 6-14. Typical test oscilloscope display of beat frequency.

7. Adjust Square Wave Timing L14 (1 μ s), L4 (10 μ s)

Accurate timing adjustment of each square wave period is made possible by mixing the output signal of the Type 284 with a time-mark signal of the Type 184, displaying the beat frequency on the test oscilloscope, then adjusting for a beat-frequency null point. The appearance of the display will depend somewhat on the bandwidth of the test oscilloscope and on the relative amplitude of the time-mark and square wave signals.

a. Use the equipment setup in Fig. 6-12. Connect the Marker Output signal from the Type 184 through a BNC 50 Ω coaxial cable to the Input 2 connector on the Type

1A1. Connect the Square Wave Output signal on the Type 284 through a GR to BNC adapter, and a BNC 50 Ω coaxial cable to the Input 1 of the Type 1A1.

b. Adjust the Trigger Level control on the test oscilloscope to obtain a beat frequency display; see Fig. 6-14.

c. Check and adjust the Square Wave Period timing following the sequence in Table 6-1. If no beat signal appears at the indicated sweep rate, set the test oscilloscope for a very slow sweep and observe the waveform. Near zero beat signal can be observed at very slow sweep showing that no adjustment is required.

d. Disconnect the 50 Ω coaxial cables from the Type 1A1.

TABLE 6-1
SQUARE WAVE ADJUSTMENTS
Beat Frequency Sweep

PERIOD	Time Mark Generator	Rate and Minimum Time/Cycle	Adjust Fig. 6-13
10 μ s	10 μ s	2 mSEC/CM	L4
1 μ s	1 μ s	.2 mSEC/CM	L14
100 ns	.1 μ s	.2 mSEC/CM	Check

8. Check Square Wave Trigger Amplitude

a. Connect a 50 Ω coaxial cable from the TRIGGER OUTPUT connector of the Type 284 to the test oscilloscope Input 1 connector. Use a 50 Ω termination at the oscilloscope input.

b. Set the test oscilloscope Volts/cm switch to .05 and the Mode switch to CH 1. Set the Time/cm switch to .1 μ s and the Triggering controls for a stable display.

c. Check that the trigger signal amplitude is 200 mV \pm 40 mV (4 cm \pm 0.8 cm); see Fig. 6-15. Also check the trigger signal amplitude with the PERIOD switch at 1 μ s and 10 μ s.

d. Disconnect the coaxial cable.

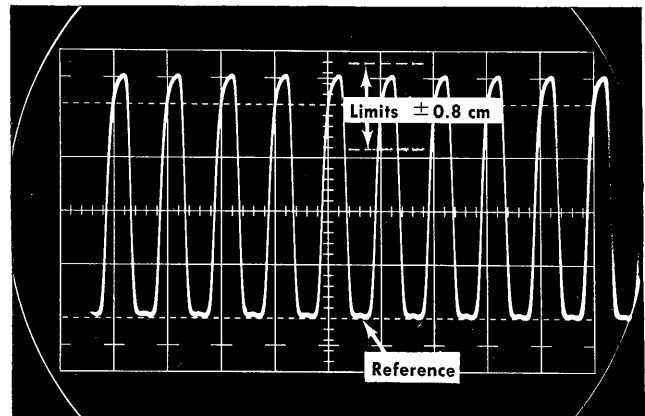

Fig. 6-15. Typical display of Trigger Output signal.

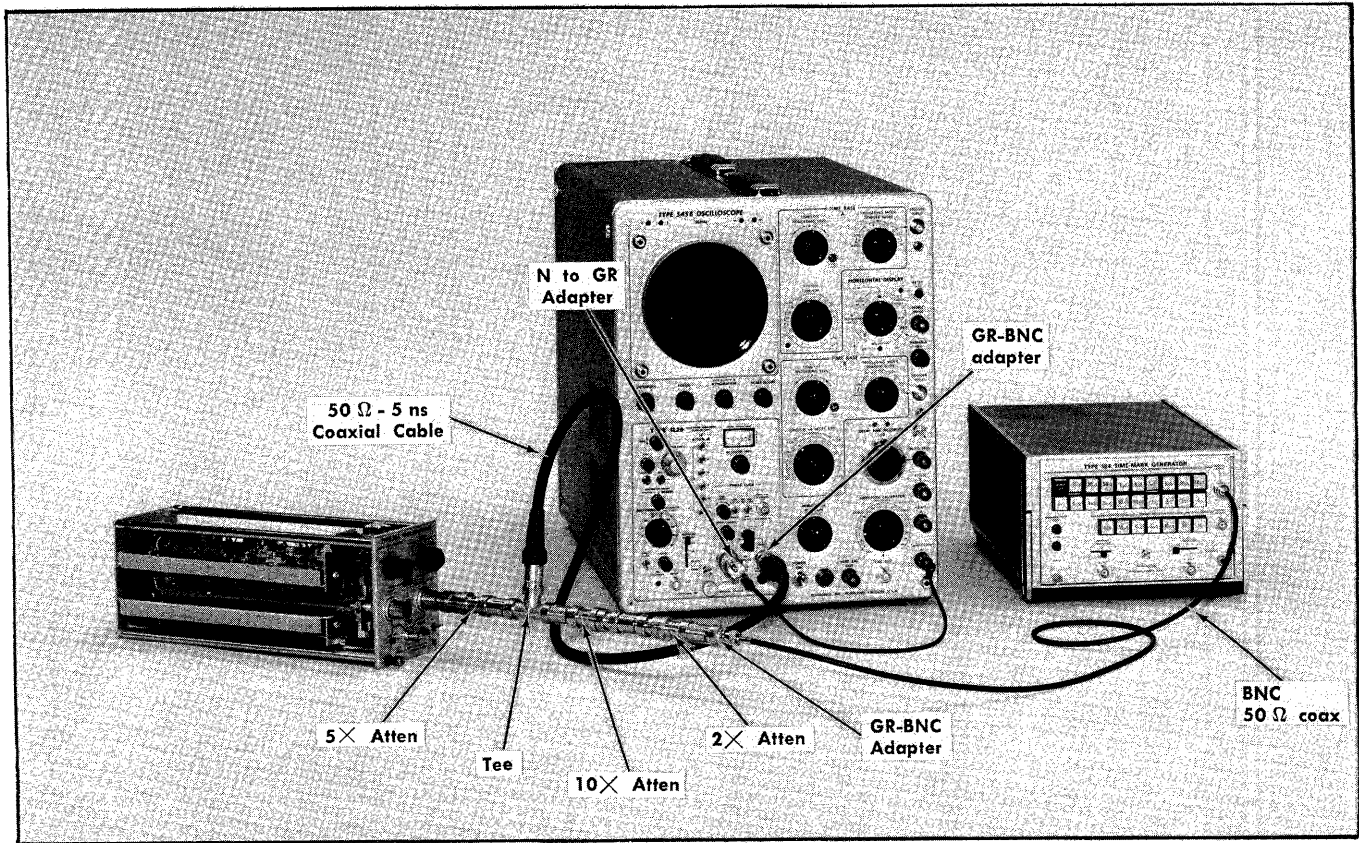

Fig. 6-16. Setup for steps 9 and 10.

Control settings

Type 284

PERIOD 10 ns
MODE SQUARE WAVE OR SINE WAVE OUTPUT

Test Oscilloscope and Type 1L20

Horizontal Display A
Time/Cm 1 ms
 Stability Clockwise
 IF Atten 20 dB on, all others off
 IF Center Freq Midrange (000)
 Fine IF Center Freq Midrange
 RF Center Freq 100
 Dispersion Range MHz/CM
 Dispersion—Coupled .5
 Resolution
 Video Filter Off (down)
 Vertical Display Log
 RF Inputs (Switch) Band 1
 Gain Midrange
 Position Midrange

Type 184

Marker selector 10 ns and 1 μs
HF Selector Off

NOTE

Check that the Type 1L20 is properly mated to the Test Oscilloscope by setting SW201 (slide switch on the rear plate of the 1L20) to the appropriate position (−150 V for Type 545B), and by checking the calibration of the front panel IF Center Freq Cal and Disp Cal adjustments. Refer to Type 1L20 instruction manual.

9. Adjust 10 ns Sine Wave Period C62

a. Requirement is for an accuracy of 10 ns period ±1% or 100 MHz ±1 MHz.

b. Use the equipment setup as shown in Fig. 6-16. Connect the Sawtooth A signal output via a BNC to banana patch cord to the 1L20 Sweep Input connector.

c. Connect the Type 184 Marker Output signal through a BNC coaxial cable and two attenuators, one 2x and one 10x, to a Tee connector; also connect the 10 ns Sine Wave signal from the Type 284 SINE WAVE OR SQUARE WAVE OUTPUT connector through a 5x attenuator to the Tee connector; connect the combined two signals from the tee connector through a coaxial cable and GR to BNC adapter to the Band 1 input connector of the Type 1L20.

d. Change the MODE switch to the PULSE OUTPUT (to the left) in order to shut the 10 ns Sine Wave off so the Type 184 Output can be observed alone as in Fig. 6-17A.

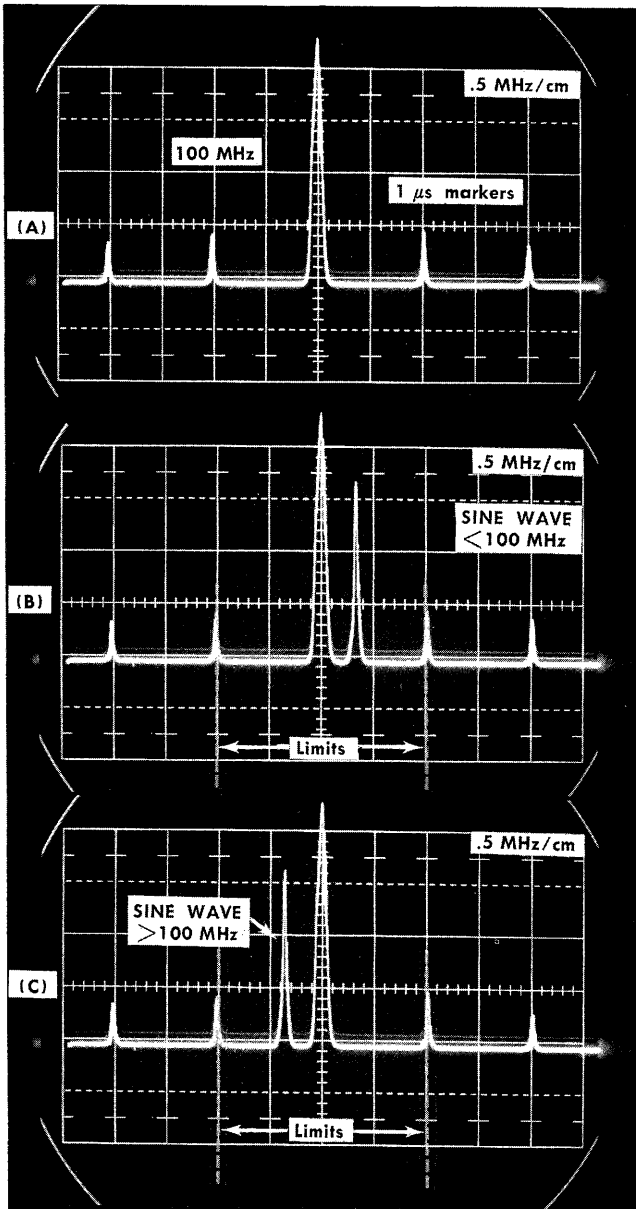

Fig. 6-17. Typical displays for step 9 showing (A) Type 184 output, (B) with Signal at a lower frequency, (C) with Signal at a higher frequency.

Slight changes in IF Center Freq, Gain, RF Center Freq and position controls may be necessary to obtain this display of 100 MHz at the center of the graticule with 1 MHz markers every 2 cm.

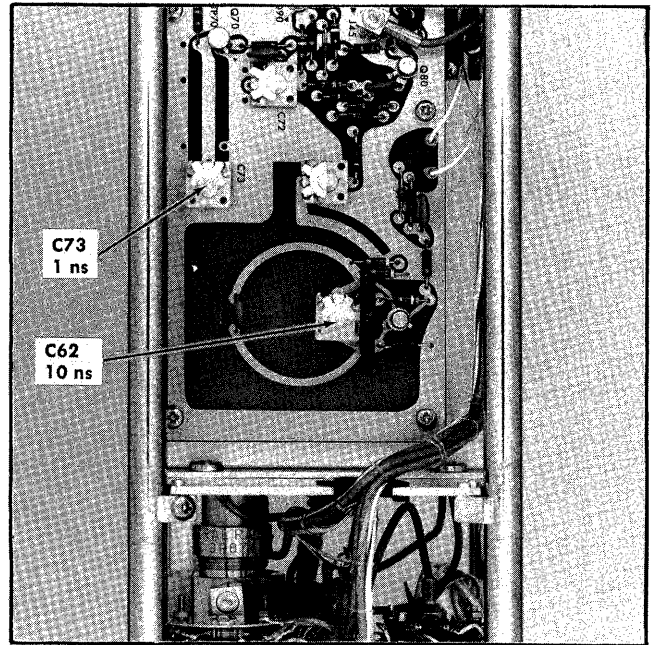

Fig. 6-18. Location of timing adjustments for steps 9 and 10.

NOTE

Since the signal from the Type 184 is a harmonic of the IF frequency of the Type 1L20, the signal can feed through the mixer and appear on the CRT without mixing with the local oscillator. This signal can be centered by the IF Center Freq control, but will appear stationary to changes in the RF Center Freq controls. In the typical displays in Fig. 6-17, the feed-through and the tuned signals are superimposed to appear as one signal. Also note that with clockwise rotation (direction of increasing frequency) of the RF Center Freq control the true signal display will move across the CRT from left to right.

e. Change the MODE switch to SQUARE WAVE OR SINE WAVE OUTPUT (to the right), and observe the signal from the Type 284 combined with the signal from the Type 184. See Fig. 6-17B and C.

f. Adjust C62 on the calibration board (Fig. 6-18 for location) to superimpose the Type 284 signal display (10 ns period or 100 MHz) with the Type 184 signal at the center of the graticule. Fig. 6-17B shows a lower frequency and a slight decrease in capacity of C62 is necessary. Fig. 6-17C shows a higher frequency.

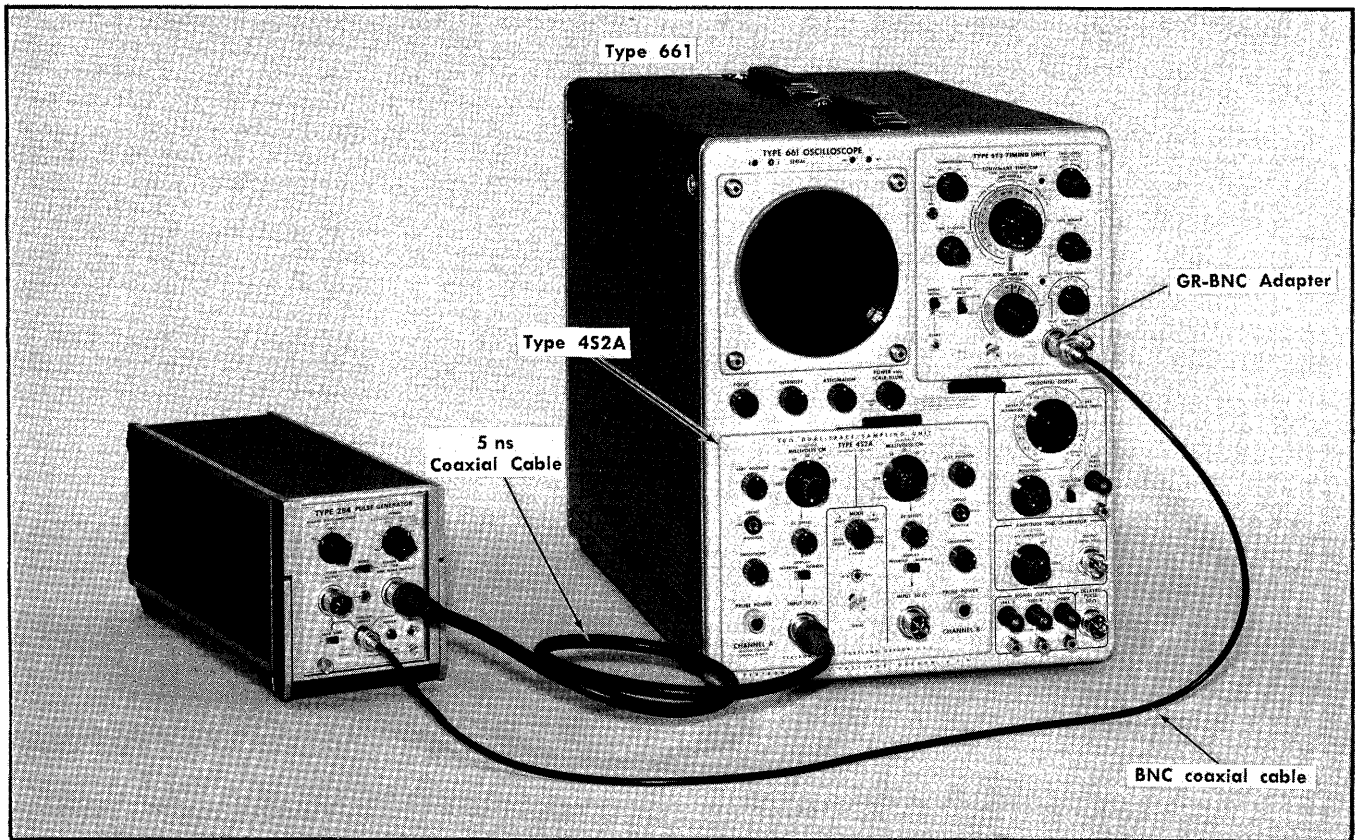

Fig. 6-19. Initial equipment setup for steps 11 and 12.

Control settings

	Type 661
Horizontal Display	×1
Position	Midrange
Vernier (Position)	Midrange
	Type 5T3
Samples/cm	100
Equivalent Time/cm	5 ns, Calibrated
Trigger Level	Midrange
Stability or UHF Sync	Midrange
Trigger Source	Ext
External Trigger Mode	50 Ω AC
Sweep Mode	Norm
	Type 452A
Millivolts/cm	20
Millivolts/cm Variable	Calibrated
Mode	A Only
Vert Position	Midrange
DC Offset	Midrange (2½ turns from one end)
Smoothing	Full Smoothing (counter- clockwise)
	Type 284
PERIOD	SINE WAVE 10 ns
MODE	SQUARE WAVE OR SINE WAVE OUTPUT

11. Adjust 10 ns Amplitude, C66 ❶

a. Use the initial equipment setup shown in Fig. 6-19, by connecting the SINE WAVE OUTPUT signal from the Type 284 through a 50 Ω coaxial cable to the Channel A 50 Ω input connector on the Type 452A. Connect TRIGGER OUTPUT signal from the Type 284 through a BNC coaxial cable and a BNC to GR adapter to the 50 Ω Ext Trig Input connector.

b. Slight adjustment of the Trigger Level control on the Type 5T3, and position control adjustments may be necessary to observe a 5 cycle sine wave display; see Fig. 6-21.

c. If the peak-to-peak amplitude is not 100 mV ±20% (5 cm ±1 cm), adjust C66 (see Fig. 6-20 for location) for an amplitude of 5 cm ±1 cm.

12. Adjust 1 ns Period Amplitude, C72 ❶

a. Use the same initial equipment setup as in step 11, and change the following controls:

	Type 5T3
Equivalent Time/cm	.5 ns, calibrated
External Trigger Mode	50 Ω UHF Sync

	Type 284
PERIOD	SINE WAVE 1 ns

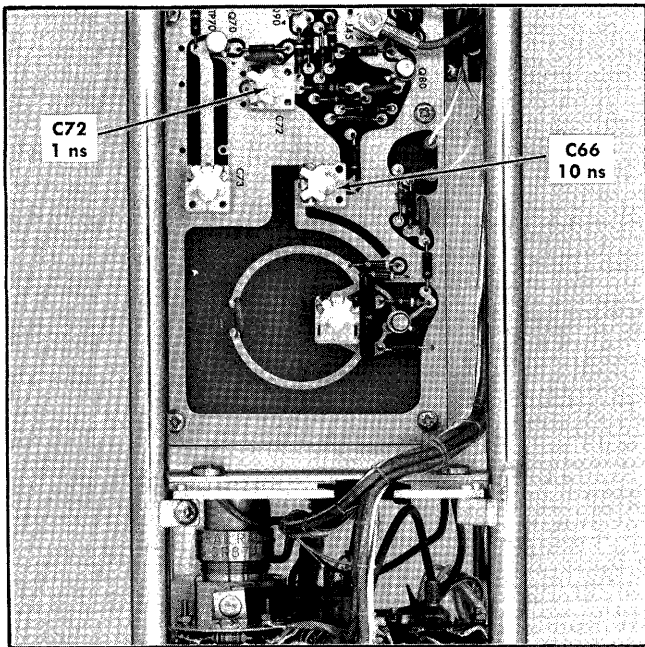

Fig. 6-20. Location of amplitude adjustments for steps 11 and 12.

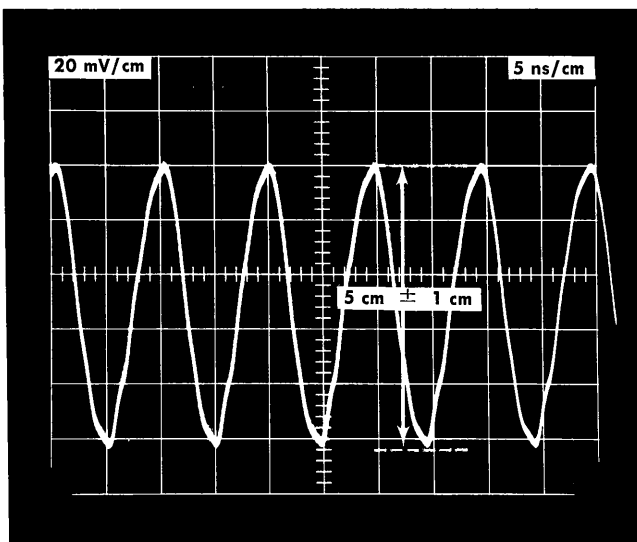

Fig. 6-21. Typical display for step 11 and similar display for step 12 showing Sine Wave amplitude.

b. Slight adjustment of the Stability or UHF Sync control on the Type 5T3 may be necessary to obtain a stable 5 cycle sine wave display.

c. If the amplitude of the Sine Wave display is $5\text{ cm} \pm 1\text{ cm}$ ($100\text{ mV} \pm 20\%$) no adjustment is recommended as a change in capacity of C72 (location shown in Fig. 6-20) especially near minimum, will affect the frequency of the 1 ns period. If adjustment of C72 is necessary to obtain a display amplitude of $5\text{ cm} \pm 1\text{ cm}$, repeat step 10.

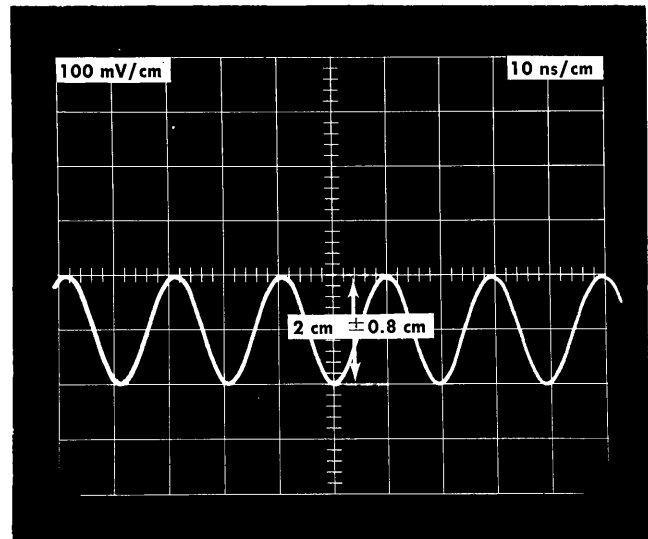

Fig. 6-22. Typical display for step 13 showing Sine Wave Trigger Output signal.

13. Check Sine Wave Trigger Amplitude

a. Disconnect the coaxial cables from the previous step and connect the TRIGGER OUTPUT signal from the Type 284 through a BNC to GR adapter and a $50\ \Omega$ coaxial cable to the Channel A Input connector on the Type 4S2A.

b. Connect the Sine Wave Output signal from the SINE WAVE OR SQUARE WAVE OUTPUT connector through a $50\ \Omega$ coaxial cable to the $50\ \Omega$ Ext Trig Input on the Type 5T3.

Change the following controls:

Type 5T3

Equivalent Time/cm	5 ns, Calibrated
Trigger Source	Ext UHF Sync

Type 4S2A

Millivolts/cm	100
---------------	-----

Type 284

PERIOD	SINE WAVE 10 ns
--------	-----------------

c. Slight adjustment of the Trigger Level control, and the Stability or UHF Sync on the Type 5T3 may be necessary to observe a 5 cycle sine wave display.

d. Check that the sine wave trigger amplitude is within $2\text{ cm} \pm 0.8\text{ cm}$, ($200\text{ mV} \pm 40\%$ peak to peak). See Fig. 6-22.

e. Change the PERIOD switch on the Type 284 to SINE WAVE 1 ns, and change the Type 5T3 Equivalent Time/cm switch to .5 ns, Calibrated. Using the same procedure check that the peak-to-peak amplitude is $2\text{ cm} \pm 0.8\text{ cm}$ ($200\text{ mV} \pm 40\%$).

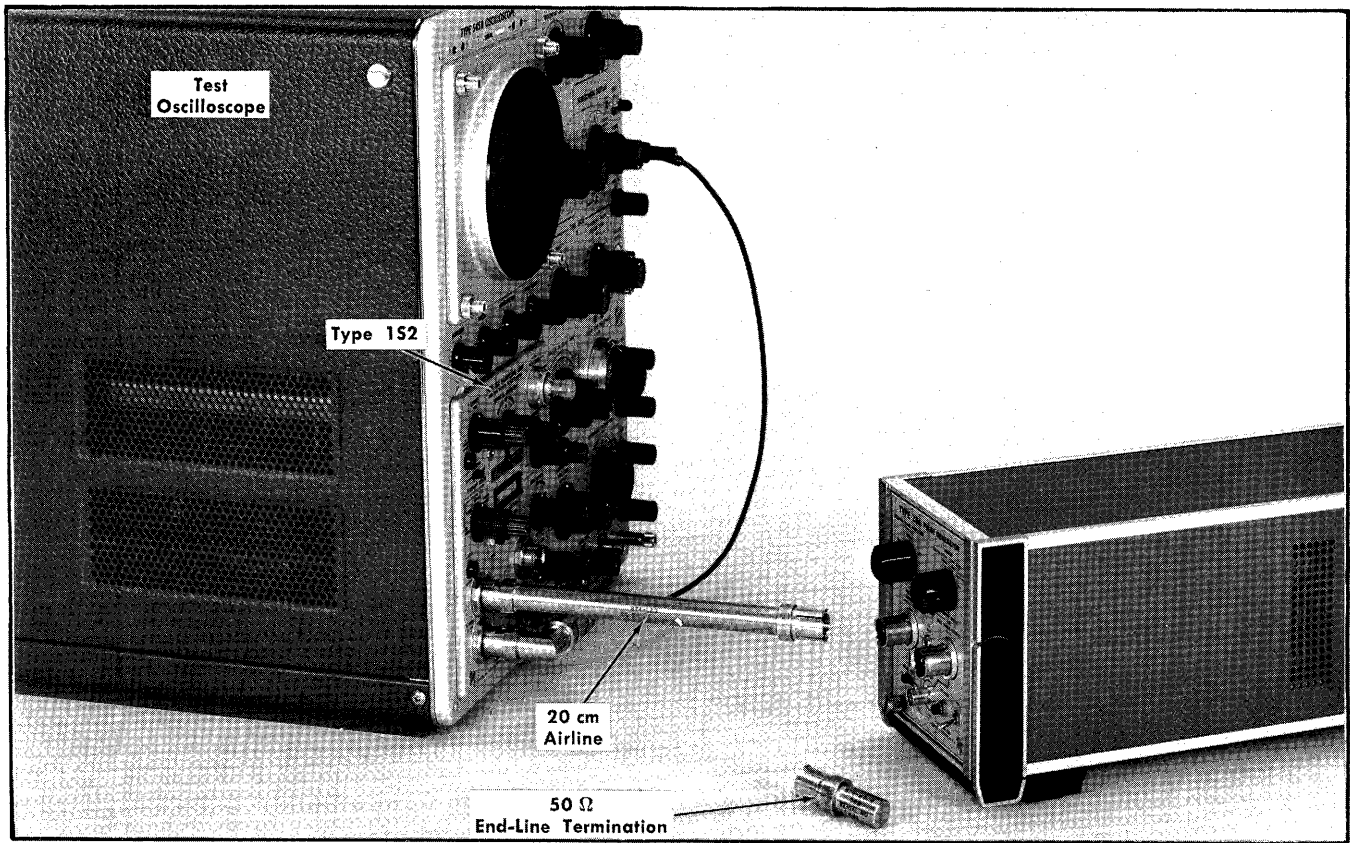

Fig. 6-23. Equipment setup for step 14.

Control settings

	Type 284				
Power	Off			Variable	Cal
				Display Mode	Normal
				Mode	Int Pulse .25 V 50 ps
				UHF Sync or Trigger Sens	Midrange
				Magnifier	×10
				Variable	Cal
				Range	.1 μs-10 m
				Dielectric	Air
				Position	0.00
				Horizontal Units/Div	Distance
				ρ-Volts	ρ
				Resolution	High
				Vert Gain (screwdriver adjustment)	Mated to the Type 545B at .5 ρ/cm (Fig. 6-24A)

NOTES

14. Check Reflections from Pulse Generator

a. Use the equipment setup as in Fig. 6-23. Join the two GR 90° elbows together to form a "U". Install the "U" to both the 0.25-Volt Pulser and the lower Thru Signal Channel 50 Ω connectors. Install a 20 cm air line (GR874-L20) to the upper Thru Signal Channel 50 Ω connector on the Type 1S2.

b. Connect the Horizontal Output of the Type 1S2 through a patch cord with banana type terminals to the Horiz Input connector on the Type 545B test oscilloscope.

c. Normal adjustments of the Horizontal Position control on the Type 545B and the Offset control (for vertical positioning) on the Type 1S2 are necessary to obtain a display as shown in Fig. 6-24A.

d. Connect a 50 Ω end line termination to the open end of the 20 cm airline, and change the Vertical Units/Div to .02. Use the Offset control to position the trace to the center of the graticule. Observe a display as in Fig. 6-24B. Note the reflections at the termination point.

NOTE

Before connecting the Type 284 to the Airline, be sure the PULSE OUTPUT connector is physically lined up to eliminate excessive strain on the connectors.

e. Remove the end line termination, and connect the Type 284 PULSE OUTPUT connector to the end of the 20 cm airline. Observe the reflections due to the Type 284 to be ±5% or ±2½ divisions as shown in Fig. 6-24C.

NOTE

Excessive reflections may be due to improper alignment of the tunnel diode assembly. Reflections of the Pulse Generator should be checked when the diode is replaced or the mounting disassembled. Refer to the maintenance section of of the manual for this information.

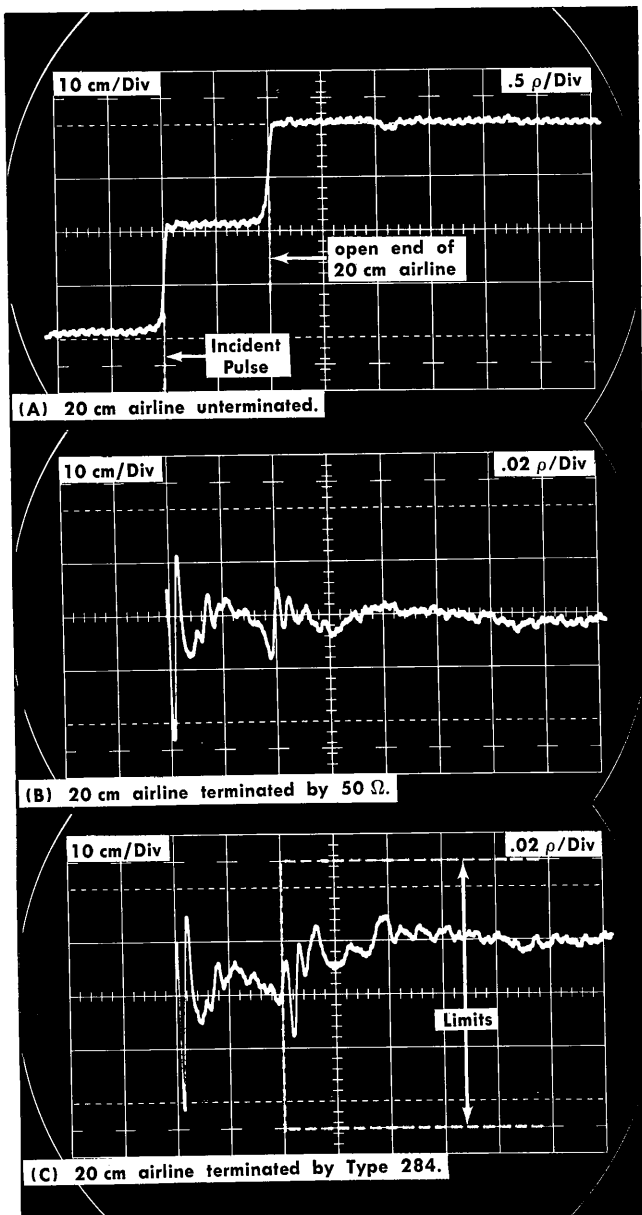

Fig. 6-24. Typical displays showing reflections.

NOTES

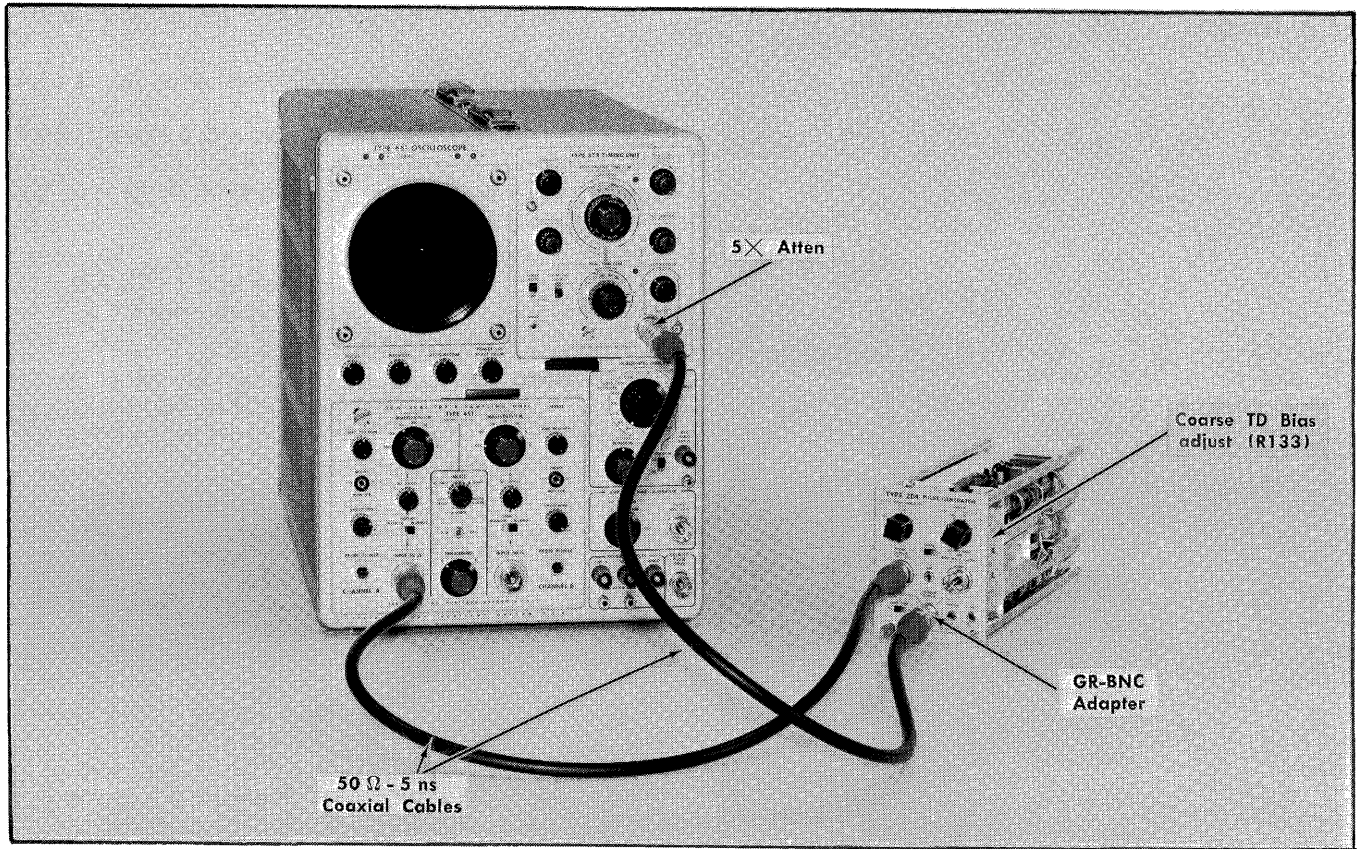

Fig. 6-25. Equipment setup for steps 15 through 24.

Control settings

Type 661		Type 451		Type 5T3	
Horizontal Display	×1	Millivolts/cm	50	Equivalent Time/cm	10 ns
Position and Vernier	Midrange	Millivolts/cm Variable	Calibrated	Equivalent Time/cm Variable	Cal
		Mode	A Only	Equivalent Time	100
		Vertical Position	Midrange	Samples/cm	
		Display	Normal	Time Position	clockwise
		DC Offset	Midrange (2½ turns from one end)	Time Position Fine	clockwise
		Smoothing	Normal	Sweep Mode	Norm
				Trig Level	clockwise
				Stability or UHF Sync	clockwise (not to detent)

Trig Source	Ext
Slope	+
Ext Trig Mode	50 Ω DC

Type 284	PULSE OUTPUT
MODE	5 ns
LEAD TIME	

15. Adjust TD BIAS (internal)

a. Use equipment setup in Fig. 6-25. Connect the PULSE OUTPUT signal from the Type 284 through a 5 ns coaxial cable to the Channel A Input 50 Ω connector on the Type 451. Connect the TRIGGER OUTPUT signal from the Type 284 through a BNC to GR adapter, a 50 Ω coaxial cable, and a 5× attenuator to the Ext Input 50 Ω connector of the Type 5T3.

b. Adjust the Trig Level on the Type 5T3 for a stable trace. The trace should appear similar to Fig. 6-26 if the TD BIAS is properly adjusted.

c. Adjust the front panel TD BIAS control (R132) to its approximate midrange position. Adjust the internal TD Bias adjustment (R133) for a trace similar to that shown in Fig. 6-26A. Note that counterclockwise rotation will show the tunnel diode not conducting (zero volts) and that clockwise rotation will show a trace at ≥ 200 mV. The correct adjustment is at the point where the diode starts to conduct as the TD BIAS control is rotated clockwise.

NOTE

If the correct display cannot be obtained by TD BIAS adjustment, refer to the following two steps (adjustment of the TD balance and the snap-off current). The TD balance adjust for zero voltage at the start of the trace and the snap-off adjustment affects the drive and the time the TD is turned on with a below threshold setting of the TD BIAS.

16. Adjust Bias Balance, R123 ①

- a. Use the equipment setup and the display as set by step 15.
- b. Remove the signal from the Channel A Input 50 Ω connector on the Type 4S1, and note vertical position of the zero-volt trace.
- c. Reconnect the signal and adjust the Bias Balance control R123 on the Pulse Generator board (see Fig. 6-27 for

location) so that the base line (the lower portion of the square wave before the positive transition) is at the same vertical position as the zero-volt trace obtained in (b).

NOTE

If no triggered display can be obtained, use the following preliminary procedure. Turn the TD BIAS control clockwise before adjusting the Bias Balance control by the above procedure. Since the TD BIAS adjustment will slightly affect the Bias Balance adjustment, step 16 must be repeated with the triggered display similar to Fig. 6-26.

17. Preliminary Adjust Snap-Off Current R174, SN B030236-up

- a. Use the equipment shown in Fig. 6-25, but connect as follows: Use two identical 50 Ω coaxial cables, one to connect the TRIGGER OUTPUT signal through a BNC to GR

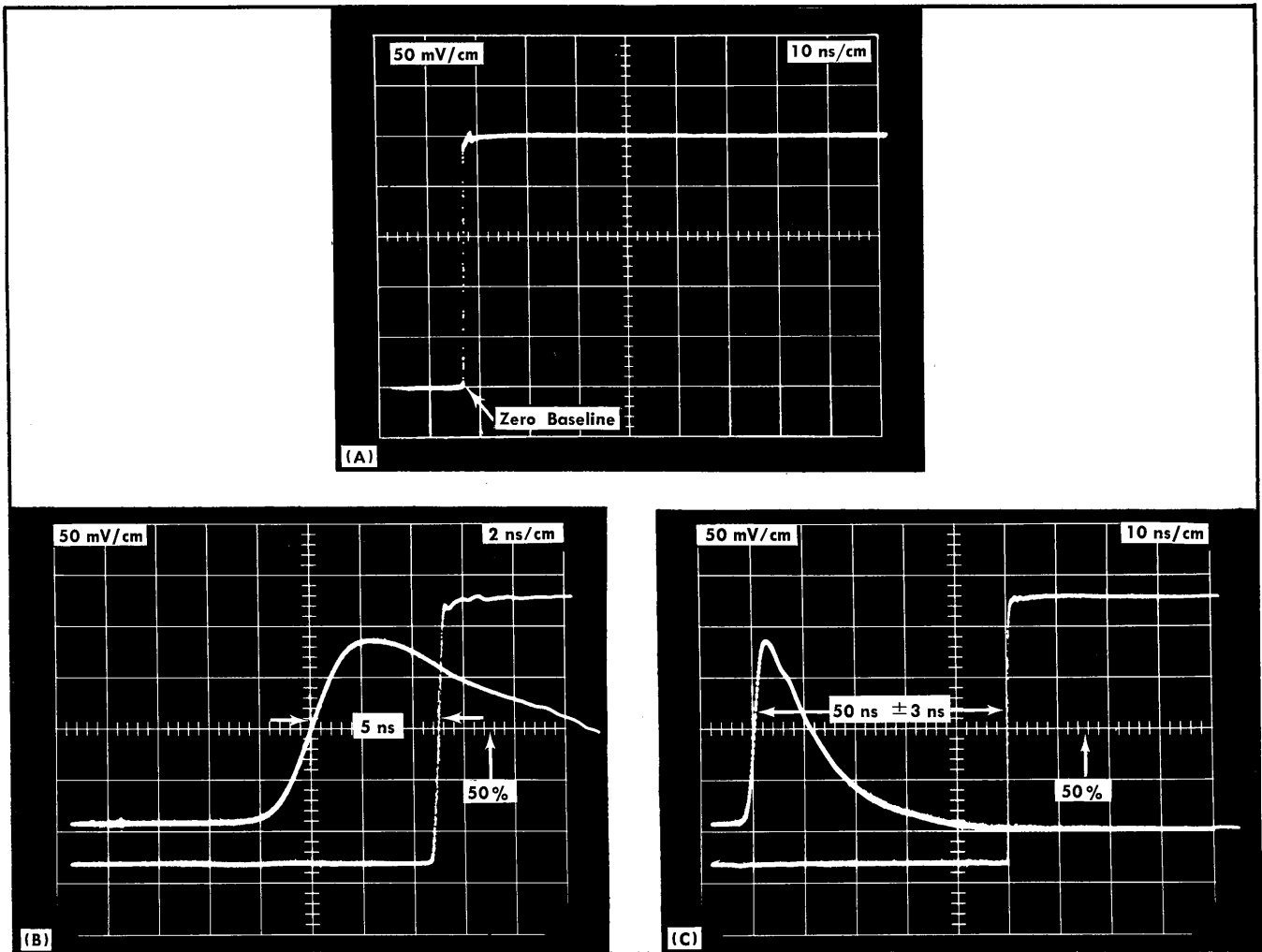

Fig. 6-26. Typical displays (A) used in steps 15 and 16, (B) used in step 17, (C) used in step 18.

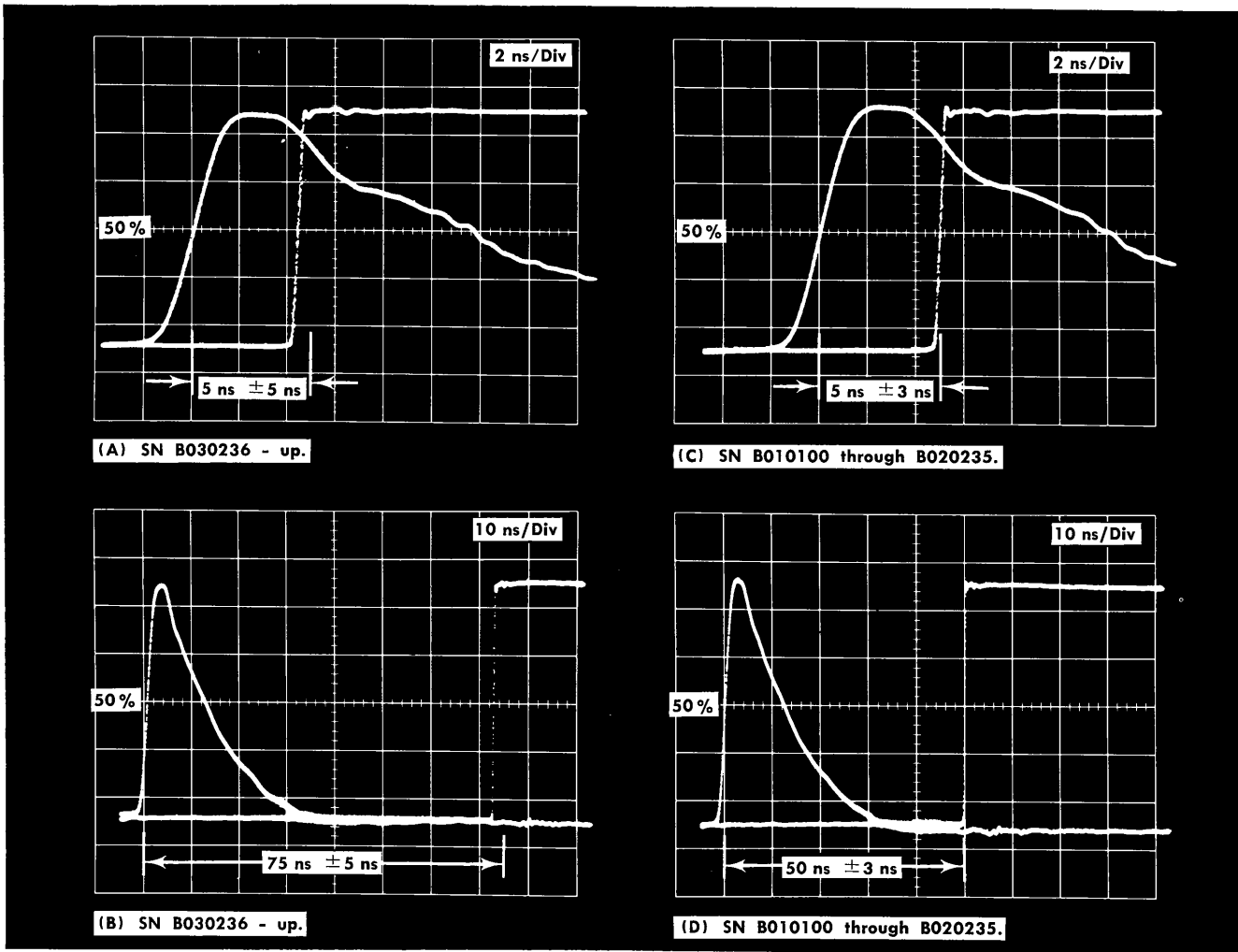

Fig. 6-27. Display when checking Lead Time tolerances.

adapter to Channel A Input 50 Ω connector; and one to connect the PULSE OUTPUT signal to Channel B Input 50 Ω connector.

b. Set the Triggering control on the Type 4S1 to A-DC, and set the Mode control to Dual-trace. Set Channel B controls the same as Channel A.

c. Change the Trigger Source switch to Int, and change the Equivalent Time/cm to 2 ns calibrated. Adjust the Trig Level control to obtain a stable trace similar to Fig. 6-27A.

d. The Snap-Off current control adjustment affects both the PULSE OUTPUT signal risetime and the jitter between the Pulse and the TRIGGER OUTPUT signal. Usually, R174 correct adjustment is about 30° from the counterclockwise end of the control. Preset the control at 30° from the counterclockwise end of its adjustment range.

The display will be similar to Fig. 6-27A, or Fig. 6-27B, depending upon position of the LEAD TIME control.

Final adjustment of the Snap-Off Current control is made just before checking the PULSE OUTPUT signal 10% to 90% risetime, Step 25.

17. Adjust Snap-Off Current R174, SN B010100 through B020235

a. Use the equipment shown in Fig. 6-25, but connect as follows: Use two identical 50 Ω coaxial cables, one to connect the TRIGGER OUTPUT signal through a BNC to GR adapter to Channel A Input 50 Ω connector; and one to connect the PULSE OUTPUT signal to Channel B Input 50 Ω connector.

b. Set the Triggering control on the Type 4S1 to A-DC, and set the Mode control to Dual-trace. Set Channel B controls the same as Channel A.

c. Change the Trigger Source switch to Int, and change the Equivalent Time/cm to 2 ns calibrated. Adjust the Trig Level control to obtain a stable trace similar to Fig. 6-26B.

d. Adjust Snapoff Current R174 (see Fig. 6-27 for location) to obtain 5 ns between the Trigger and the Pulse display. Readjust the TD BIAS control as necessary to obtain a stable PULSE OUTPUT display.

e. Use this display for the next step.

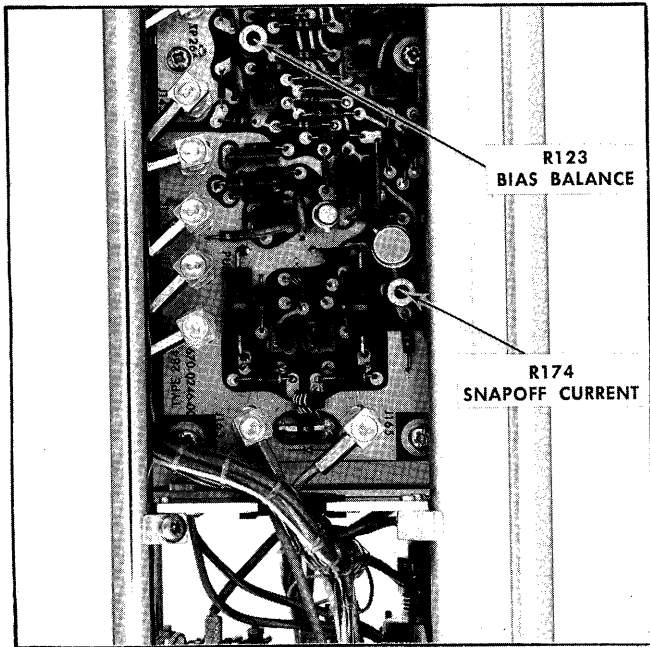

Fig. 6-28. Location of adjustments for steps 16 and 17.

18. Check Lead Time 75 ns for SN B030236-up (50 ns, SN B010100 through B020235)

- Use the equipment and the displayed waveform as in step 17. Change the Equipment Time/cm to 10 ns, and adjust the Time Position control on the Type 5T3 so the 50% amplitude point of the Trigger display is one cm from the start of the trace.
- Change the LEAD TIME switch on the Type 284 to 75 ns, and observe a display similar to Fig. 6-27B.
- Check that the time between the Trigger and the Pulse is 5 cm ± 0.5 cm or 75 ns ± 5 ns.
- Use the same setup for the following step.

19. Check Pulse Trigger Amplitude

- Use the same setup as the preceding step and set the Type 4S1 Mode switch to A Only. Position the base of the Pulse Trigger waveform to a graticule line.
- Measure the Pulse Trigger amplitude to be 4 cm ± 0.8 cm (200 mV $\pm 20\%$) as shown in Fig. 6-29A. If the amplitude is low, check step 21 first and then repeat this step.

20. Check Pulse Trigger Width

- Use the same setup as the preceding step and set the Equivalent Time/cm switch to 2 ns.
- Measure the Pulse Trigger width at the 50% amplitude points, and position the display so the 50% points are at the center graticule line.

- Check that the width is not less than 5 cm (10 ns); see Fig. 6-29B.

21. Check Pulse Trigger Risetime

- Use the same setup as the preceding step. Set the Equivalent Time/cm switch to 1 ns, calibrated, and turn the Time Position control counterclockwise for a display similar to Fig. 6-29C.
- Set the Millivolts/cm switch and Variable control for a 5 cm display amplitude.
- Measure the risetime between the 10% and 90% points.
- Check that the risetime is not more than 3 ns (3 cm).

NOTE

The amplitude, width and risetime of the Pulse TRIGGER OUTPUT is affected by the characteristics of the Avalanche transistor Q150. If Q150 is changed, repeat steps 19, 20 and 21.

22. Check Pulse Amplitude

- Use the same setup, and change the Mode switch of the Type 4S1 to B Only.
- Set the Equivalent Time/cm switch to the 2 μ s position, then pull the Magnifier knob and turn it to the .2 μ s position. This maintains a Time Position Range of 100 μ s.
- Change the Time Position control slowly counterclockwise to position the Pulse Output display in the center of the graticule area.
- Set the base of the Pulse on a graticule line and measure the amplitude which should be 4 cm or more (200 mV or more); see Fig. 6-30A.

23. Check Pulse Width

- Use the same setup and display as the preceding step. Position the pulse so the 50% amplitude points are at the center graticule line.
- Measure the Pulse Width to be between 5 and 7.5 cm (1 μ s $+50\%$ -0% at the 50% amplitude points). See Fig. 6-30B.

24. Check Pulse Repetition Rate

- Use the same setup as the preceding step. Change the Equivalent Time/cm switch to .5 μ s Calibrated.
- Change the Time Position control slightly to obtain a two-pulse display as shown in Fig. 6-30C.
- Check that the time between pulses is 20 μ s ± 2 μ s (4 cm $\pm .4$ cm) showing a pulse repetition rate of 50 kHz $\pm 10\%$.

3T2 Random Sampling Sweep operated in a 560 Series oscilloscope. If using this alternate equipment, see the Type S-2 Performance Check/Recalibration Procedure for details.

25. Final Adjust of Snap-Off Current Control R174, and Check of PULSE OUTPUT Signal Risetime, ≤ 70 ps, SN BO30236-up

NOTE

Instruments with SN B010100 through B020235 are checked in the second step 25 that applies to those earlier serial numbers.

If using the Type 284 to drive systems with 50 ps to 100 ps risetimes, perform all parts of this step 25, and adjust the Snap-Off Current control as described.

If using the Type 284 to drive systems whose risetime is no faster than 350 ps, leave the Snap-Off Current control at its preset position as set in step 17. The preset position assures proper risetime

(as checked in this step). The minimizing of pulse jitter mentioned in part f below cannot be seen in 350 ps risetime systems, and therefore additional adjustment of the Snap-Off Current control will not produce an improvement in the display. Thus make the Snap-Off Current control adjustments (in part f) only when driving a sampling system with a risetime in the order of 50 to 70 ps.

a. Use the equipment setup as in Fig. 6-31 or as described in the Type S-2 Sampling Head Performance Check/Recalibration Procedure. (Fastest method of adjusting the Snap-Off Current control is to operate a Type S-2/Type 3S2 in a Type 568 with Type 230 Digital Unit. Operate the digital unit for a 10% to 90% risetime readout.)

b. Connect the PULSE OUTPUT signal from the Type 284 through a 20 cm coaxial airline to the Channel A Input 50 Ω connector.

c. Adjust the Trigger Level and the Time Position control for a stable trace.

d. Adjust the Millivolt/cm Variable control on the Type 4S2A for 5 cm of vertical display peak to peak.

e. Adjust the Time Position control for a display similar to Fig. 6-32.

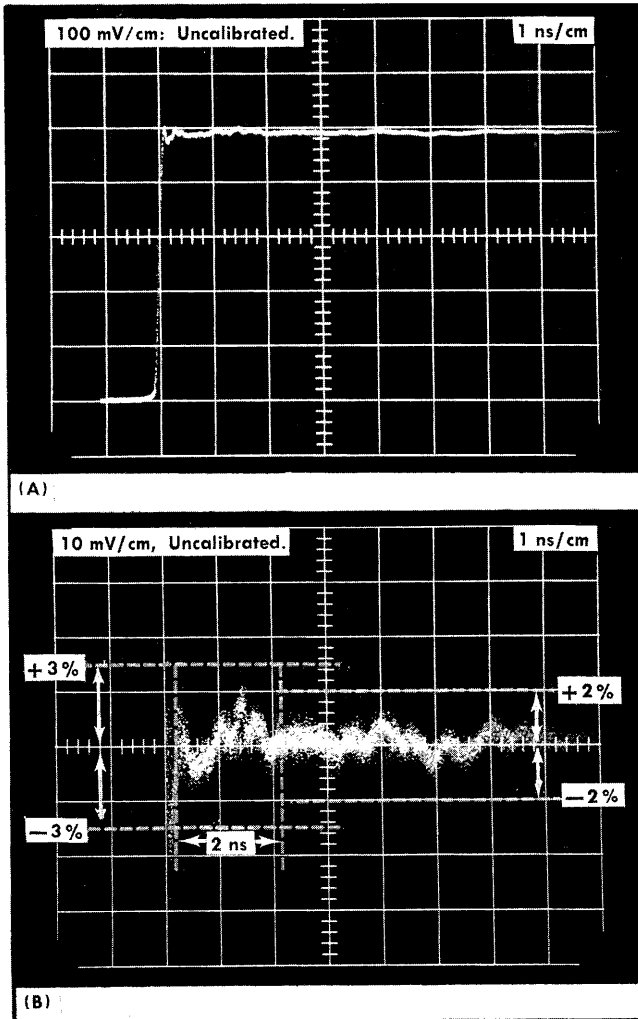

Fig. 6-33. Typical display of Flatness Deviation with Type 4S2A Vertical Sampling Unit.

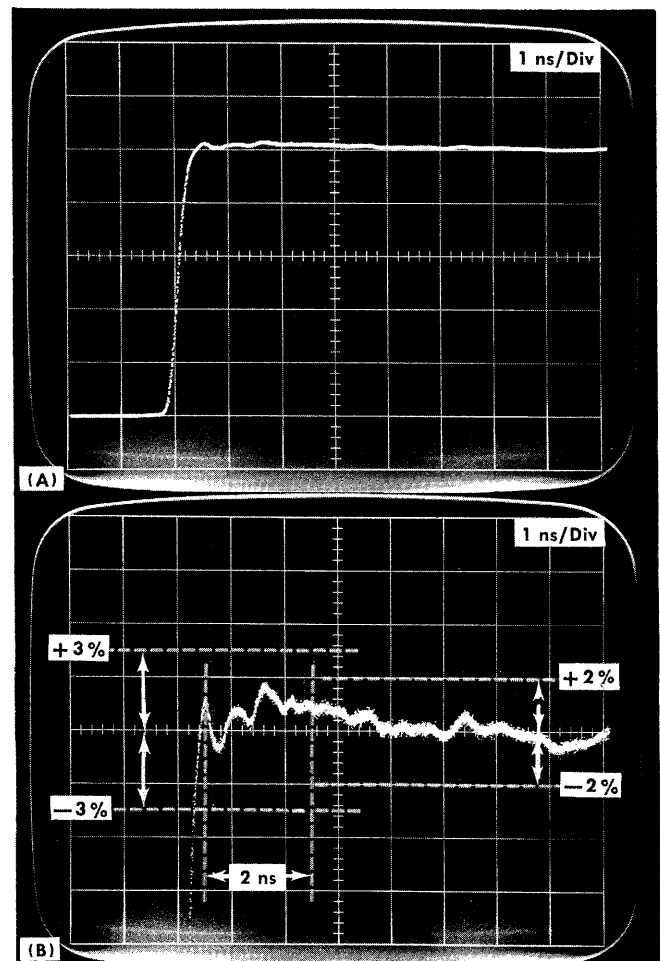

Fig. 6-34. Typical display of Flatness Deviation with Type 3S1 Vertical Sampling Unit.

Calibration—Type 284

f. Measure the pulse risetime. Using a Type 4S2A, the displayed risetime must be ≤ 114 ps. Regardless of what it reads, slowly adjust the Snap-Off Current control (and keep the display in view with the Time Position control) a few degrees clockwise and check for both an increased rate of rise and less time jitter of the displayed pulse. Then slowly adjust the Snap-Off Current control a few degrees counterclockwise and repeat the checks. Leave the control set at a point that causes the fastest rate of rise and least time jitter.

25. Check Pulse Risetime, ≤ 70 ps, SN B010100 through B020235

- Use the equipment setup as in Fig. 6-31.
- Connect the PULSE OUTPUT signal from the Type 284 through a 20 cm coaxial airline to the Channel A Input 50 Ω connector.
- Adjust the Trigger Level and the Time Position control for a stable trace.
- Adjust the Millivolt/cm Variable control on the Type 4S2A for 5 cm of vertical display peak to peak.
- Adjust the Time Position control for a display similar to Fig. 6-32.
- Measure the risetime of the PULSE OUTPUT signal observed with the Sampling Oscilloscope to be less than 114 ps.

NOTE

Since the Sampling Oscilloscope risetime (≤ 90 ps) is slower than the Type 284 risetime (≤ 70 ps), the Sampling Oscilloscope risetime must be considered. If the risetime of the applied pulse approaches the risetime of the system, the actual

risetime may be approximated by the following equation:

$$T_r \text{ measured} = (T_r \text{ Pulse})^2 + (T_r \text{ System})^2$$

Substituting ≤ 70 ps (the risetime of the Type 284 and the T_r Pulse) and substituting ≤ 90 ps (the risetime of the Type 4S2A Sampling Vertical Unit) the T_r measured will equal 114 ns or less.

26. Check Pulse Flatness Deviation

- Use the equipment setup as shown in Fig. 6-31.
- Change the Equivalent Time/cm switch to 1 ns Calibrated, and adjust the Trigger Level and Time Position controls for a stable trace.
- Set the Millivolts/cm switch to 100 and set the Variable control for a 5 cm display, similar to Fig. 6-33A.
- Change the Millivolts/cm control to 10 (increase amplitude by 10 times), and position the trace to observe the positive portion of the Pulse at the center of the graticule as shown in Fig. 6-33B.
- Check the flatness deviation during the first 2 ns (2 cm) after the pulse reaches 100% amplitude to the ≤ 1.5 cm (3%) p-p total over a range of from +1.5 cm to -1.5 cm and after 2 ns (2 cm) to be ≤ 1 cm (2%) p-p total over a range from +1 cm to -1 cm.

Part of the deviations observed are attributed to the Type 4S2A Vertical Sampling Unit. The specification is for the Type 284 only. Fig. 6-34 shows a typical display of the deviations of the Type 284 with the Type 3S1 Vertical Sampling Unit. This was taken using similar procedure to step 26. For other typical displays of the Type 284 with other sampling units refer to the Operating Section of this manual.

PARTS LIST ABBREVIATIONS

BHB	binding head brass	int	internal
BHS	binding head steel	lg	length or long
cap.	capacitor	met.	metal
cer	ceramic	mtg hdw	mounting hardware
comp	composition	OD	outside diameter
conn	connector	OHB	oval head brass
CRT	cathode-ray tube	OHS	oval head steel
csk	countersunk	P/O	part of
DE	double end	PHB	pan head brass
dia	diameter	PHS	pan head steel
div	division	plstc	plastic
elect.	electrolytic	PMC	paper, metal cased
EMC	electrolytic, metal cased	poly	polystyrene
EMT	electrolytic, metal tubular	prec	precision
ext	external	PT	paper, tubular
F & I	focus and intensity	PTM	paper or plastic, tubular, molded
FHB	flat head brass	RHB	round head brass
FHS	flat head steel	RHS	round head steel
Fil HB	fillister head brass	SE	single end
Fil HS	fillister head steel	SN or S/N	serial number
h	height or high	S or SW	switch
hex.	hexagonal	TC	temperature compensated
HHB	hex head brass	THB	truss head brass
HHS	hex head steel	thk	thick
HSB	hex socket brass	THS	truss head steel
HSS	hex socket steel	tub.	tubular
ID	inside diameter	var	variable
inc	incandescent	w	wide or width
		WW	wire-wound

PARTS ORDERING INFORMATION

Replacement parts are available from or through your local Tektronix, Inc. Field Office or representative.

Changes to Tektronix instruments are sometimes made to accommodate improved components as they become available, and to give you the benefit of the latest circuit improvements developed in our engineering department. It is therefore important, when ordering parts, to include the following information in your order: Part number, instrument type or number, serial or model number, and modification number if applicable.

If a part you have ordered has been replaced with a new or improved part, your local Tektronix, Inc. Field Office or representative will contact you concerning any change in part number.

SPECIAL NOTES AND SYMBOLS

- | | |
|-----------------|---|
| ×000 | Part first added at this serial number |
| 00× | Part removed after this serial number |
| *000-0000-00 | Asterisk preceding Tektronix Part Number indicates manufactured by or for Tektronix, Inc., or reworked or checked components. |
| Use 000-0000-00 | Part number indicated is direct replacement. |

SECTION 7

ELECTRICAL PARTS LIST

Values are fixed unless marked Variable.

Ckt. No.	Tektronix Part No.	Serial/Model No. Eff Disc	Description			
Bulb						
B270	150-0045-00		Incandescent #685			
Capacitors						
Tolerance $\pm 20\%$ unless otherwise indicated.						
C3	285-0595-00		0.1 μF	PTM	100 V	1%
C4	285-0595-00		0.1 μF	PTM	100 V	1%
C13	283-0593-00		0.01 μF	Mica	100 V	1%
C14	283-0593-00		0.01 μF	Mica	100 V	1%
C21	283-0599-00		98 pF	Mica	500 V	5%
C22	281-0504-00		10 pF	Cer	500 V	10%
C25	283-0003-00		0.01 μF	Cer	150 V	
C38	290-0135-00		15 μF	Elect.	20 V	
C42	290-0135-00		15 μF	Elect.	20 V	
C44	283-0026-00		0.2 μF	Cer	25 V	
C56	283-0026-00		0.2 μF	Cer	25 V	
C61	283-0602-00		53 pF	Mica	300 V	5%
C62	281-0081-00		1.8-13 pF, Var	Air		
C63	283-0602-00		53 pF	Mica	300 V	5%
C64	283-0067-00		0.001 μF	Cer	200 V	10%
C65	283-0067-00		0.001 μF	Cer	200 V	10%
C66	281-0081-00		1.8-13 pF, Var	Air		
C72	281-0076-00		1.2-3.5 pF, Var	Air		
C73	281-0076-00		1.2-3.5 pF, Var	Air		
C74 ¹						
C76	283-0067-00		0.001 μF	Cer	200 V	10%
C81	283-0032-00		470 pF	Cer	500 V	5%
C84	283-0067-00		0.001 μF	Cer	200 V	10%
C91	283-0032-00		470 pF	Cer	500 V	5%
C101	285-0650-00		0.027 μF	PTM	100 V	5%
C102	285-0702-00		0.033 μF	PTM	100 V	5%
C105	283-0109-00		21 pF	Cer	1000 V	5%
C106	283-0026-00		0.2 μF	Cer	25 V	
C115	283-0605-00		678 pF	Mica	300 V	1%
C121	283-0109-00		27 pF	Cer	1000 V	5%

¹Part of E.C. Board.

Electrical Parts List—Type 284

Capacitors (cont)

Ckt. No.	Tektronix Part No.	Serial/Model No. Eff	No. Disc	Description			
C129	283-0109-00			27 pF	Cer	1000 V	5%
C139	283-0109-00			27 pF	Cer	1000 V	5%
C149	283-0109-00			27 pF	Cer	1000 V	5%
C151	283-0026-00			0.2 μ F	Cer	25 V	
C152	283-0605-00			678 pF	Mica	300 V	1%
C153	283-0026-00			0.2 μ F	Cer	25 V	
C154	283-0109-00			27 pF	Cer	1000 V	5%
C156	283-0128-00	B010100	B029999	100 pF	Cer	500 V	5%
C156	283-0603-00	B030000		113 pF	Cer	300 V	2%
C159	283-0109-00			27 pF	Cer	1000 V	5%
C161	283-0067-00			0.001 μ F	Cer	200 V	10%
C163	283-0025-00	B010100	B059999	0.0005 μ F	Cer	500 V	5%
C163	283-0121-00	B060000		0.001 μ F	Cer	200 V	
C165	283-0067-00			0.001 μ F	Cer	200 V	10%
C167	283-0025-00	B010100	B059999	0.005 μ F	Cer	500 V	5%
C167	283-0121-00	B060000		0.001 μ F	Cer	200 V	
C170	283-0026-00			0.2 μ F	Cer	25 V	
C178	283-0067-00			0.001 μ F	Cer	200 V	10%
C185 ²							
C186 ²							
C210	290-0334-00			1250 μ F	Elect.	50 V	+75%—10%
C226	290-0215-00			100 μ F	Elect.	25 V	
C227	283-0128-00			100 pF	Cer	500 V	5%
C240	290-0334-00			1250 μ F	Elect.	50 V	
C266	290-0215-00			100 μ F	Elect.	25 V	

Diodes

D5	*152-0185-00		Silicon	Replaceable by 1N4152
D15	*152-0185-00		Silicon	Replaceable by 1N4152
D25	*152-0185-00		Silicon	Replaceable by 1N4152
D35	*152-0185-00		Silicon	Replaceable by 1N4152
D84	*152-0185-00		Silicon	Replaceable by 1N4152
D94	*152-0185-00		Silicon	Replaceable by 1N4152
D102	*152-0185-00		Silicon	Replaceable by 1N4152
D105	*152-0185-00		Silicon	Replaceable by 1N4152
D127	*152-0185-00		Silicon	Replaceable by 1N4152
D132	*152-0075-00		Germanium	Tek Spec
D133	*152-0075-00		Germanium	Tek Spec
D134	*152-0075-00		Germanium	Tek Spec
D142	*152-0075-00		Germanium	Tek Spec
D143	*152-0075-00		Germanium	Tek Spec
D144	*152-0075-00		Germanium	Tek Spec
D150	*152-0185-00		Silicon	Replaceable by 1N4152

²Furnished as a unit with Tunnel Diode Assembly (*119-0148-00).

Diodes (cont)

Ckt. No.	Tektronix Part No.	Serial/Model No. Eff	Disc		Description	
D151	*152-0185-00			Silicon	Replaceable by 1N4152	
D152	*152-0185-00			Silicon	Replaceable by 1N4152	
D165	*152-0252-00	B010100	B010129	Silicon	Snap-Off	
D165	*152-0335-00	B010130		Silicon	Snap-Off	
D180	152-0329-00			Tunnel	21 mA	20%
D210	152-0066-00			Silicon	1N3194	
D212	152-0066-00			Silicon	1N3194	
D220	152-0212-00			Zener	1N936	9 V, 5% TC
D240	152-0066-00			Silicon	1N3194	
D242	152-0066-00			Silicon	1N3194	

Delay Line Assembly

DL158	*119-0146-00	B010100	B029999	Delay Line Assembly
DL158	119-0146-01	B030000		Delay Line Assembly

Fuses

F200	159-0048-00		1/10 A	3AG Slo-Blo
F202	159-0051-00		1/16 A	3AG Slo-Blo

Connectors

J45	131-0391-00			Coaxial, 50 Ω , Male
J55	131-0391-00			Coaxial, 50 Ω , Male
J95	131-0391-00			Coaxial, 50 Ω , Male
J135	131-0391-00			Coaxial, 50 Ω , Male
J145	131-0391-00			Coaxial, 50 Ω , Male
J150	131-0391-00			Coaxial, 50 Ω , Male
J155	131-0391-00			Coaxial, 50 Ω , Male
J158	131-0391-00			Coaxial, 50 Ω , Male
J160	131-0391-00			Coaxial, 50 Ω , Male
J163	131-0391-00			Coaxial, 50 Ω , Male
J165	131-0391-00			Coaxial, 50 Ω , Male
J180	131-0548-00			Coaxial, Receptacle
J181 ³				
J184	131-0548-00			Coaxial, Receptacle
J185	131-0548-00			Coaxial, Receptacle
J186	131-0548-00			Coaxial, Receptacle

³Furnished as a unit with Tunnel Diode Assembly (*119-0148-00).

Electrical Parts List—Type 284

Connectors (Cont)

Ckt. No.	Tektronix Part No.	Serial/Model No. Eff	Disc	Description
P45*				
P55*				
P95*				
P135*				
P145*				
P155*				
P158*				
P160*				
P180*				
P184*				

Inductors

L4	114-0236-00			49-53 μ H	Core not available separately
L14	*114-0222-00			2-6 μ H, Var	Core 276-0568-00
L21	*114-0222-00			2-6 μ H, Var	Core 276-0568-00
L61	108-0240-00			820 μ H	
L66	*108-0182-00			0.3 μ H	
L101	108-0240-00			820 μ H	

Transistors

Q1	151-0190-00			Silicon	2N3904
Q10	151-0190-00			Silicon	2N3904
Q20	151-0190-00			Silicon	2N3904
Q30	151-0221-00			Silicon	2N4258
Q35	151-0221-00			Silicon	2N4258
Q40	151-0221-00			Silicon	2N4258
Q50	151-0190-00			Silicon	2N3904
Q55	151-0221-00			Silicon	2N4258
Q60	*151-0108-00			Silicon	Replaceable by 2N2501
Q70	151-0173-00			Silicon	2N3478
Q80	*151-0138-00			Silicon	Replaceable by 2N2857
Q90	*151-0138-00			Silicon	Replaceable by 2N2857
Q100	151-0188-00			Silicon	2N3906
Q110	151-0190-00			Silicon	2N3904
Q111	151-0190-00			Silicon	2N3904
Q120	151-0190-00			Silicon	2N3904
Q125	151-0188-00			Silicon	2N3906
Q130	151-0188-00			Silicon	2N3906
Q135	151-0190-00			Silicon	2N3904
Q140	151-0190-00			Silicon	2N3904
Q145	151-0188-00			Silicon	2N3906
Q150	*151-0083-00	B010100	B049999	Germanium	Tek Spec
Q150	*153-0560-00	B050000		Germanium	2N964, checked
Q160	151-0190-00			Silicon	2N3904
Q165	151-0188-00			Silicon	2N3906
Q170	*151-0136-00			Silicon	Replaceable by 2N3053
Q220A	151-0188-00			Silicon	2N3906
Q220B	151-0188-00			Silicon	2N3906

*Part of Cable Assembly (*179-1212-00). See Mechanical Parts List.

Transistors (cont)

Ckt. No.	Tektronix Part No.	Serial/Model No. Eff	Disc	Description
Q230	151-0188-00		Silicon	2N3906
Q235	*151-0148-00		Silicon	Selected from 40250
Q245	*151-0148-00		Silicon	Selected from 40250
Q250	151-0190-00		Silicon	2N3904
Q260A	151-0190-00		Silicon	2N3904
Q260B	151-0190-00		Silicon	2N3904

Resistors

Resistors are fixed, composition, $\pm 10\%$ unless otherwise indicated.

R1	315-0101-00		100 Ω	$\frac{1}{4}$ W		5%
R4	315-0271-00		270 Ω	$\frac{1}{4}$ W		5%
R5	301-0202-00		2 k Ω	$\frac{1}{2}$ W		5%
R8	315-0103-00		10 k Ω	$\frac{1}{4}$ W		5%
R11	315-0101-00		100 Ω	$\frac{1}{4}$ W		5%
R14	315-0101-00		100 Ω	$\frac{1}{4}$ W		5%
R15	301-0152-00		1.5 k Ω	$\frac{1}{2}$ W		5%
R18	315-0103-00		10 k Ω	$\frac{1}{4}$ W		5%
R23	315-0223-00		22 k Ω	$\frac{1}{4}$ W		5%
R24	315-0203-00		20 k Ω	$\frac{1}{4}$ W		5%
R25	301-0102-00		1 k Ω	$\frac{1}{2}$ W		5%
R28	315-0512-00		5.1 k Ω	$\frac{1}{4}$ W		5%
R31	311-0541-00		20 k Ω , Var			
R32	315-0123-00		12 k Ω	$\frac{1}{4}$ W		5%
R34	315-0392-00		3.9 k Ω	$\frac{1}{4}$ W		5%
R35	315-0102-00		1 k Ω	$\frac{1}{4}$ W		5%
R38	323-0125-00		196 Ω	$\frac{1}{2}$ W	Prec	1%
R39	323-0125-00		196 Ω	$\frac{1}{2}$ W	Prec	1%
R40	307-0113-00		5.1 Ω	$\frac{1}{4}$ W		5%
R42	301-0472-00	B010100	B059999	4.7 k Ω	$\frac{1}{2}$ W	5%
R42	301-0562-00	B060000		5.6 k Ω	$\frac{1}{2}$ W	5%
R44	315-0222-00		2.2 k Ω	$\frac{1}{4}$ W		5%
R46	315-0101-00		100 Ω	$\frac{1}{4}$ W		5%
R48	315-0560-00		56 Ω	$\frac{1}{4}$ W		5%
R50	321-0249-00		3.83 k Ω	$\frac{1}{8}$ W	Prec	1%
R51	311-0442-00		250 Ω , Var			
R52	321-0187-00		866 Ω	$\frac{1}{8}$ W	Prec	1%
R54	315-0101-00		100 Ω	$\frac{1}{4}$ W		5%
R56	301-0472-00		4.7 k Ω	$\frac{1}{2}$ W		5%
R58	323-0626-01		50 Ω	$\frac{1}{2}$ W	Prec	$\frac{1}{2}\%$
R62	315-0391-00		390 Ω	$\frac{1}{4}$ W		5%
R63	315-0102-00		1 k Ω	$\frac{1}{4}$ W		5%
R64	315-0101-00		100 Ω	$\frac{1}{4}$ W		5%
R66	315-0472-00		4.7 k Ω	$\frac{1}{4}$ W		5%
R67	315-0472-00		4.7 k Ω	$\frac{1}{4}$ W		5%
R71	315-0242-00		2.4 k Ω	$\frac{1}{4}$ W		5%
R75	315-0272-00		2.7 k Ω	$\frac{1}{4}$ W		5%
R76	315-0101-00		100 Ω	$\frac{1}{4}$ W		5%
R81	315-0332-00		3.3 k Ω	$\frac{1}{4}$ W		5%
R84	315-0302-00		3 k Ω	$\frac{1}{4}$ W		5%
R85	315-0200-00		20 Ω	$\frac{1}{4}$ W		5%
R87	315-0330-00		33 Ω	$\frac{1}{4}$ W		5%
R91	315-0332-00		3.3 k Ω	$\frac{1}{4}$ W		5%

Resistors (cont)

Ckt. No.	Tektronix Part No.	Serial/Model No.		Description		
		Eff	Disc			
R92	315-0510-00			51 Ω	1/4 W	5%
R94	315-0392-00			3.9 kΩ	1/4 W	5%
R95	315-0750-00			75 Ω	1/4 W	5%
R96	315-0391-00			390 Ω	1/4 W	5%
R98A	321-0752-06			40.91 Ω	1/8 W	Prec 1/4%
R98B	321-0752-06			40.91 Ω	1/8 W	Prec 1/4%
R98C	325-0024-00			20.2 Ω	1/8 W	Prec 1/4%
R98D	325-0024-00			20.2 Ω	1/8 W	Prec 1/4%
R99A	321-0752-06			40.91 Ω	1/8 W	Prec 1/4%
R99B	321-0752-06			40.91 Ω	1/8 W	Prec 1/4%
R99C	325-0024-00			20.2 Ω	1/8 W	Prec 1/4%
R99D	325-0024-00			20.2 Ω	1/8 W	Prec 1/4%
R103	315-0512-00			5.1 kΩ	1/4 W	5%
R105	315-0102-00			1 kΩ	1/4 W	5%
R111	315-0472-00			4.7 kΩ	1/4 W	5%
R112	315-0562-00			5.6 kΩ	1/4 W	5%
R115	315-0623-00			62 kΩ	1/4 W	5%
R117	315-0183-00			18 kΩ	1/4 W	5%
R121	315-0222-00			2.2 kΩ	1/4 W	5%
R122	315-0153-00			15 kΩ	1/4 W	5%
R123	311-0614-00			30 kΩ, Var		
R124	315-0153-00			15 kΩ	1/4 W	5%
R125	315-0103-00			10 kΩ	1/4 W	5%
R127	315-0103-00			10 kΩ	1/4 W	5%
R129	315-0222-00			2.2 kΩ	1/4 W	5%
R131	301-0362-00	B010100	B039999	3.6 kΩ	1/2 W	5%
R131	301-0302-00	B040000		3 kΩ	1/2 W	5%
R132	311-0487-00	B010100	B039999	30 kΩ, Var		
R132	311-0629-00	B040000		3 kΩ, Var		
R133	311-0487-00	XB040000		30 kΩ, Var		
R134	315-0182-00			1.8 kΩ	1/4 W	5%
R136	315-0100-00			10 Ω	1/4 W	5%
R138	317-0390-00			39 Ω	1/8 W	5%
R139	317-0750-00			75 Ω	1/8 W	5%
R141	301-0362-00	B010100	B039999	3.6 kΩ	1/2 W	5%
R141	301-0302-00	B040000		3 kΩ	1/2 W	5%
R144	315-0182-00			1.8 kΩ	1/4 W	5%
R146	315-0100-00			10 Ω	1/4 W	5%
R148	317-0390-00			39 Ω	1/8 W	5%
R149	317-0750-00			75 Ω	1/8 W	5%
R150	315-0153-00			15 kΩ	1/4 W	5%
R151	317-0182-00			1.8 kΩ	1/8 W	5%
R152	315-0753-00			75 kΩ	1/4 W	5%
R154	315-0272-00			2.7 kΩ	1/4 W	5%
R155	315-0101-00			100 Ω	1/4 W	5%
R156	315-0182-00			1.8 kΩ	1/4 W	5%
R157	315-0101-00			100 Ω	1/4 W	5%
R159	315-0510-00			51 Ω	1/4 W	5%
R161	315-0102-00			1 kΩ	1/4 W	5%
R162	303-0221-00			220 Ω	1 W	5%
R163	315-0470-00			47 Ω	1/4 W	5%
R165	315-0102-00			1 kΩ	1/4 W	5%

Resistors (cont)

Ckt. No.	Tektronix Part No.	Serial/Model No. Eff	No. Disc	Description	
R167	315-0470-00		47 Ω	1/4 W	5%
R170	315-0100-00		10 Ω	1/4 W	5%
R174	311-0607-00		10 kΩ, Var		
R175	315-0153-00		15 kΩ	1/4 W	5%
R178	303-0221-00		220 Ω	1 W	5%
R180	315-0751-00		750 Ω	1/4 W	5%
R184A	307-0132-00		54 Ω	1/2 W	1/2%
R184B	317-0391-00		390 Ω	1/8 W	5%
R184C	317-0271-00		270 Ω	1/8 W	5%
R185 ⁵	315-0510-00		51 Ω	1/4 W	5%
R186 ⁶	315-0510-00		51 Ω	1/4 W	5%
R210	315-0100-00		10 Ω	1/4 W	5%
R222	315-0152-00		1.5 kΩ	1/4 W	5%
R224	315-0432-00		4.3 kΩ	1/4 W	5%
R226	321-0215-00		1.69 kΩ	1/8 W	Prec 1%
R227	311-0442-00		250 Ω, Var		
R228	321-0223-00		2.05 kΩ	1/8 W	Prec 1%
R231	315-0183-00		18 kΩ	1/4 W	5%
R233	315-0102-00		1 kΩ	1/4 W	5%
R234	315-0102-00		1 kΩ	1/4 W	5%
R240	315-0100-00		10 Ω	1/4 W	5%
R245	315-0332-00		3.3 kΩ	1/4 W	5%
R250	315-0222-00		2.2 kΩ	1/4 W	5%
R254	315-0512-00		5.1 kΩ	1/4 W	5%
R256	315-0183-00		18 kΩ	1/4 W	5%
R260	315-0101-00		100 Ω	1/4 W	5%
R262	315-0103-00		10 kΩ	1/4 W	5%
R264	321-0263-00		5.36 kΩ	1/8 W	Prec 1%
R266	321-0263-00		5.36 kΩ	1/8 W	Prec 1%

Switches

Unwired or Wired

SW90	260-0883-00	B010100	B059999	Rotary	PERIOD
SW90	260-0883-01	B060000		Rotary	PERIOD
SW92	260-0816-00			Slide	MODE
SW95	Wired *262-0815-00			Rotary	SQUARE WAVE AMPLITUDE
SW95	260-0882-00			Rotary	SQUARE WAVE AMPLITUDE
SW158	260-0816-00			Slide	LEAD TIME
SW201	260-0834-00			Toggle	ON
SW205 ⁷					

⁵Furnished as a unit with W185.

⁶Furnished as a unit with W186.

⁷See Mechanical Parts List. Line Voltage Selector Body.

Electrical Parts List—Type 284**Transformers**

Ckt. No.	Tektronix Part No.	Serial/Model No. Eff	No. Disc	Description
T65 ⁸				
T72 ⁸				
T160	*120-0508-00			Toroid, 3 windings
T165	*120-0444-00			Toroid, 5 turns, bifilar
T201	*120-0507-00			Power

Test Points

TP30	*214-0579-00			Connector, Test Point
TP70	*214-0579-00			Connector, Test Point
TP111	*214-0579-00			Connector, Test Point
TP226	*214-0579-00			Connector, Test Point
TP262	*214-0579-00			Connector, Test Point
TP266	*214-0579-00			Connector, Test Point

Cable Assemblies

W90	*175-0462-00			Cable Assembly, 6 inch
W150	*175-1213-00			Cable Assembly
W185	*175-0465-00			Cable Assembly RF (8-22)
W186	*175-0464-00			Cable Assembly RF (8-44)

Crystal

Y22	158-0031-01			10 MHz
-----	-------------	--	--	--------

⁸Part of E.C. Board.

FIGURE AND INDEX NUMBERS

Items in this section are referenced by figure and index numbers to the illustrations which appear either on the back of the diagrams or on pullout pages immediately following the diagrams of the instruction manual.

INDENTATION SYSTEM

This mechanical parts list is indented to indicate item relationships. Following is an example of the indentation system used in the Description column.

Assembly and/or Component
Detail Part of Assembly and/or Component
mounting hardware for Detail Part
Parts of Detail Part
mounting hardware for Parts of Detail Part
mounting hardware for Assembly and/or Component

Mounting hardware always appears in the same indentation as the item it mounts, while the detail parts are indented to the right. Indented items are part of, and included with, the next higher indentation.

Mounting hardware must be purchased separately, unless otherwise specified.

PARTS ORDERING INFORMATION

Replacement parts are available from or through your local Tektronix, Inc. Field Office or representative.

Changes to Tektronix instruments are sometimes made to accommodate improved components as they become available, and to give you the benefit of the latest circuit improvements developed in our engineering department. It is therefore important, when ordering parts, to include the following information in your order: Part number, instrument type or number, serial or model number, and modification number if applicable.

If a part you have ordered has been replaced with a new or improved part, your local Tektronix, Inc. Field Office or representative will contact you concerning any change in part number.

Change information, if any, is located at the rear of this manual.

ABBREVIATIONS AND SYMBOLS

For an explanation of the abbreviations and symbols used in this section, please refer to the page immediately preceding the Electrical Parts List in this instruction manual.

INDEX OF MECHANICAL PARTS LIST ILLUSTRATIONS

(Located behind diagrams)

FIG. 1 FRONT & REAR

FIG. 2 CHASSIS, CIRCUIT BOARDS & DELAY LINE

FIG. 3 CABINET

FIG. 4 ACCESSORIES

SECTION 8

MECHANICAL PARTS LIST

FIG. 1 FRONT & REAR

Fig. & Index No.	Tektronix Part No.	Serial/Model No.		Q † y	Description	
		Eff	Disc			1
1-1	333-1015-01			1	PANEL, front	
-2	386-1287-00			1	PLATE, front sub-panel	
-3	- - - - -			1	CONNECTOR, coaxial, (see Ref. #52, Fig. 2)	
-4	260-0816-00			1	SWITCH, slide—LEAD TIME	
	- - - - -			-	mounting hardware: (not included w/switch)	
-5	211-0030-00			2	SCREW, 2-56 x 1/4 inch, FHS	
-6	210-0405-00			2	NUT, hex., 2-56 x 3/16 inch	
-7	260-0816-00			1	SWITCH, slide—MODE	
	- - - - -			-	mounting hardware: (not included w/switch)	
-8	211-0030-00			2	SCREW, 2-56 x 1/4 inch, FHS	
-9	210-0405-00			2	NUT, hex., 2-56 x 3/16 inch	
-10	260-0834-00			1	SWITCH, toggle—POWER ON	
	- - - - -			-	mounting hardware: (not included w/switch)	
-11	210-0046-00			1	LOCKWASHER, internal, 0.261 ID x 0.400 inch OD	
-12	210-0940-00			1	WASHER, flat, 1/4 ID x 3/8 inch OD	
-13	210-0562-00			1	NUT, hex., 1/4-40 x 5/16 inch	
-14	358-0255-00			1	BUSHING, plastic, latch	
-15	214-0553-00			1	LATCH SCREW	
-16	- - - - -			1	RESISTOR, variable	
	- - - - -			-	mounting hardware: (not included w/resistor)	
-17	210-0471-00			1	NUT, hex., 1/4-32 x 5/16 x 1 1/32 inch long	
-18	210-0046-00			1	LOCKWASHER, internal, 0.261 ID x 0.400 inch OD	
-19	358-0054-00			1	BUSHING, 1/4-32 x 0.406 inch long	
-20	210-0204-00			1	LUG, solder, DE #6	
	- - - - -			-	mounting hardware: (not included w/lug)	
-21	210-0407-00			1	NUT, hex., 6-32 x 1/4 inch	
-22	136-0223-00			1	SOCKET, light	
	- - - - -			-	mounting hardware: (not included w/socket)	
-23	210-0223-00			1	LUG, solder, 1/4 ID x 7/16 inch OD, SE	
-24	210-0583-00			1	NUT, hex., 1/4-32 x 5/16 inch	
-25	366-0322-01			1	KNOB, charcoal—SQUARE WAVE AMPLITUDE	
	- - - - -			-	knob includes:	
	213-0004-00			1	SCREW, set, 6-32 x 3/16 inch, HSS	

FIG. 1 FRONT & REAR (cont)

Fig. & Index No.	Tektronix Part No.	Serial/Model Eff	No. Disc	Q † y	Description				
					1	2	3	4	5
1-26	262-0815-00			1	SWITCH, wired—SQUARE WAVE AMPLITUDE				
	- - - - -			-	switch includes:				
	260-0882-00			1	SWITCH, unwired				
	- - - - -			-	mounting hardware: (not included w/switch)				
-27	210-0012-00			1	LOCKWASHER, internal, $\frac{3}{8}$ ID x $\frac{1}{2}$ inch OD				
-28	210-0978-00			1	WASHER, flat, $\frac{3}{8}$ ID x $\frac{1}{2}$ inch OD				
-29	210-0590-00			1	NUT, hex., $\frac{3}{8}$ -32 x $\frac{7}{16}$ inch				
-30	366-0322-01			1	KNOB, charcoal—PERIOD				
	- - - - -			-	knob includes:				
	213-0004-00			1	SCREW, set, 6-32 x $\frac{3}{16}$ inch, HSS				
-31	260-0883-00			1	SWITCH, unwired				
	- - - - -			-	mounting hardware: (not included w/switch)				
-32	210-0012-00			1	LOCKWASHER, internal, $\frac{3}{8}$ ID x $\frac{1}{2}$ inch OD				
-33	210-0978-00			1	WASHER, flat, $\frac{3}{8}$ ID x $\frac{1}{2}$ inch OD				
-34	210-0590-00			1	NUT, hex., $\frac{3}{8}$ -32 x $\frac{7}{16}$ inch				
-35	351-0096-00			1	GUIDE, rail, 12- $\frac{1}{4}$ inches long				
	- - - - -			-	mounting hardware: (not included w/guide)				
	211-0559-00			2	SCREW, 6-32 x $\frac{3}{8}$ inch, FHS				
	214-0680-00			1	PIN, guide				
-36	384-0615-00			3	ROD, frame, 12- $\frac{3}{8}$ inches long				
-37	131-0102-01			1	ASSEMBLY, motor base				
	- - - - -			-	assembly includes:				
-38	129-0041-01			1	POST, ground				
-39	200-0185-01			1	COVER, black plastic				
-40	211-0132-00			1	SCREW, sems, 4-40 x $\frac{1}{2}$ inch, PHS				
-41	213-0088-00			1	SCREW, thread forming, 4-40 x $\frac{1}{4}$ inch, PHS				
-42	214-0078-00			2	PIN, connecting				
-43	377-0051-00			1	INSERT				
-44	386-0933-00			1	PLATE, mounting				
	- - - - -			-	mounting hardware: (not included w/assembly)				
-45	211-0507-00			2	SCREW, 6-32 x $\frac{5}{16}$ inch, PHS				
-46	210-0457-00			2	NUT, keps, 6-32 x $\frac{5}{16}$ inch				
-47	175-0462-00			1	ASSEMBLY, 6 inch RF cable				
	- - - - -			-	assembly includes:				
-48	132-0002-00			1	SLEEVE CONDUCTOR, outer				
-49	132-0029-00			1	INNER CONDUCTOR				
-50	132-0028-00			1	INSULATOR, plastic				
-51	132-0116-00			1	INNER TRANSITION				
-52	132-0007-00			1	SNAP RING				
-53	132-0115-00			1	OUTER TRANSITION				
-54	166-0221-00			1	TUBE, ferrule				
-55	132-0001-00			1	NUT COUPLING				
	- - - - -			-	mounting hardware: (not included w/assembly)				
-56	132-0040-00			1	ADAPTER, panel				
-57	132-0121-00			1	NUT, retaining				
-58	211-0099-00			4	SCREW, 4-40 x $\frac{5}{16}$ inch, FHS				

FIG. 1 FRONT & REAR (cont)

Fig. & Index No.	Tektronix Part No.	Serial/Model Eff	No. Disc	Q					Description	
				t	y	1	2	3		4
1-59	214-0680-00			1						PIN, guide
	- - - - -			-						mounting hardware: (not included w/pin)
-60	210-0458-00			1						NUT, keps, 8-32 x 1 ¹ / ₃₂ inch
-61	204-0281-00			1						BODY, voltage selector
	- - - - -			-						mounting hardware: (not included w/body)
-62	210-0407-00			2						NUT, hex., 6-32 x 1 ¹ / ₄ inch
	210-0006-00			2						LOCKWASHER, internal #6
-63	200-0706-00			1						COVER, voltage selector
	- - - - -			-						cover includes:
-64	352-0102-00			2						HOLDER, plastic, fuse
	- - - - -			-						mounting hardware: (not included w/holder)
-65	213-0088-00			2						SCREW, thread forming, #4 x 1 ¹ / ₄ inch, PHS
-66	386-1288-00			1						PLATE, rear
	- - - - -			-						mounting hardware: (not included w/plate)
-67	212-0044-00			4						SCREW, 8-32 x 1 ¹ / ₂ inch, RHS
-68	175-0464-00			1						ASSEMBLY, RF cable (striped yellow) w/male connectors
-69	175-0465-00			1						ASSEMBLY, RF cable (striped red) w/male connectors
-70	119-0148-00			1						ASSEMBLY, TUNNEL DIODE
	- - - - -			-						assembly includes:
-71	132-0002-00			1						SLEEVE, outer conductor
-72	132-0029-00			1						CONDUCTOR, inner
-73	132-0028-00			2						INSULATOR, plastic
-74	103-0055-00			2						ADAPTER
-75	132-0007-00			3						RING, snap
-76	132-0001-00			3						NUT, coupler
-77	132-0121-00			1						NUT, hex.
-78	213-0006-00			1						SCREW, set, 8-32 x 3 ³ / ₁₆ inch, HSS
-79	214-0970-00			3						SPRING, contact
-80	214-0977-00			1						BALL, 0.125 inch diameter
-81	131-0528-00			1						CONTACT, electrical
-82	131-0548-00			4						CONNECTOR, feed thru
-83	407-0387-00			1						BRACKET, connector
-84	211-0089-00			2						SCREW, 2-56 x 0.375 inch, RHS
-85	204-0317-00			1						BODY, pulse generator
-86	214-0957-00			1						SUPPORT, transmission line section
-87	205-0084-00			1						SHELL, transmission line
-88	131-0529-00			1						CONTACT, electrical
-89	119-0136-00			1						LINE, section, RF transmission
-90	210-1054-00			1						WASHER, flat
-91	131-0531-00			1						CONTACT, electrical
-92	358-0330-00			1						BUSHING, sleeve
-93	205-0085-00			1						SHELL, termination
	- - - - -			-						mounting hardware: (not included w/assembly)
-94	132-0040-00			1						ADAPTER, panel
-95	211-0101-00			4						SCREW, 4-40 x 1 ¹ / ₄ inch, 100 csk, FHS

FIG. 2 CHASSIS, CIRCUIT BOARDS & DELAY LINE

Fig. & Index No.	Tektronix Part No.	Serial/Model Eff	No. Disc	Q					Description
				t	1	2	3	4	
2-1	441-0749-00			1					CHASSIS, pulser power
	- - - - -			-					mounting hardware: (not included w/chassis)
	211-0507-00			4					SCREW, 6-32 x 5/16 inch, PHS
-2	348-0115-00			1					GROMMET, plastic
-3	344-0118-00			2					CLIP, capacitor mounting
	- - - - -			-					mounting hardware for each: (not included w/clip)
-4	213-0044-00			1					SCREW, thread forming, 5-32 x 1/4 inch, PHS
-5	407-0388-00			1					BRACKET, transistor mounting
	- - - - -			-					mounting hardware: (not included w/bracket)
-6	211-0507-00			2					SCREW, 6-32 x 5/16 inch, PHS
-7	- - - - -			2					TRANSISTOR
	- - - - -			-					mounting hardware for each: (not included w/transistor)
-8	211-0510-00			2					SCREW, 6-32 x 3/8 inch, PHS
-9	386-0143-00			1					PLATE, mica, insulating
-10	210-0811-00			2					WASHER, fiber, shouldered, #6
-11	210-0802-00			2					WASHER, flat, 0.150 ID x 5/16 inch OD
-12	210-0202-00			1					LUG, solder, SE #6
-13	210-0006-00			1					LOCKWASHER, internal, #6
-14	210-0407-00			2					NUT, hex., 6-32 x 1/4 inch
-15	- - - - -			1					TRANSFORMER
	- - - - -			-					mounting hardware: (not included w/transformer)
-16	211-0131-00			2					SCREW, 4-40 x 17/8 inches
-17	214-0956-00			1					NUT, bar, 4-40 x 1/4 x 1 3/4 inches long
-18	344-0116-00			1					CLIP, mounting
	- - - - -			-					mounting hardware: (not included w/clip)
-19	211-0097-00			1					SCREW, thread forming, 4-40 x 5/16 PHS
-20	386-1289-00			1					PLATE, chassis support
	- - - - -			1					RESISTOR, variable (not shown)
	- - - - -			-					mounting hardware: (not included w/resistor)
	407-0042-00			1					BRACKET
	211-0507-00			1					SCREW, 6-32 x 5/16 inch, PHS
	210-0046-00			1					WASHER, lock, internal, 0.261 ID x 0.400 inch OD
	210-0940-00			1					WASHER, flat, 1/4 ID x 3/8 inch OD
	210-0583-00			1					NUT, hex., 1/4-32 x 5/16 inch
-21	348-0055-00			1					GROMMET, plastic, 1/4 inch diameter
-22	358-0215-00			2					BUSHING, plastic

FIG. 2 CHASSIS, CIRCUIT BOARDS & DELAY LINE (cont)

Fig. & Index No.	Tektronix Part No.	Serial/Model No.		Q † y	Description
		Eff	Disc		
2-23	119-0146-00	B010100	B029999	1	ASSEMBLY, delay line
	119-0146-01	B030000		1	ASSEMBLY, delay line
	- - - - -			-	assembly includes:
	407-0495-00	XB030000		1	BRACKET
-24	129-0140-00	B010100	B029999	2	POST, non-metallic
	129-0184-00	B030000		2	POST, non-metallic
	- - - - -			-	mounting hardware for each: (not included w/post)
-25	211-0507-00	B010100	B029999	2	SCREW, 6-32 x 5/16 inch, PHS
	210-0586-00	B030000		2	NUT, keps, 4-40 x 1/4 inch
-26	386-1326-00			2	PLATE, retaining
-27	200-0803-00			1	COVER, delay line
	- - - - -			-	mounting hardware: (not included w/cover)
-28	211-0101-00			8	SCREW, 4-40 x 1/4 inch, FHS
	- - - - -			-	mounting hardware: (not included w/assembly)
-29	211-0097-00			4	SCREW, 4-40 x 5/16 inch, PHS
-30	441-0748-00			1	CHASSIS, oscillator
	- - - - -			-	mounting hardware: (not included w/chassis)
-31	211-0507-00			4	SCREW, 6-32 x 5/16 inch, PHS
-32	343-0088-00			2	CLAMP, plastic, snap-in small
-33	670-0247-00			1	ASSEMBLY, circuit board—CALIBRATOR
	- - - - -			-	assembly includes:
	388-0898-00			1	BOARD, circuit
-34	131-0391-00			3	CONNECTOR, coaxial, one contact, male
-35	136-0220-00			6	SOCKET, transistor, 3 pin
-36	136-0252-00	B010100	B030299	21	SOCKET, pin connector
	136-0252-01	B030300		21	SOCKET, pin connector
-37	214-0506-00			8	CONNECTOR, square pin
-38	214-0579-00			2	CONNECTOR, test point
	- - - - -			-	mounting hardware: (not included w/assembly)
-39	211-0116-00			6	SCREW, sems, 4-40 x 5/16 inch, PHS
-40	179-1212-00			1	CABLE HARNESS, 284
-41	670-0246-00	B010100	B039999	1	ASSEMBLY, circuit board—PULSE GENERATOR
	670-0246-01	B040000		1	ASSEMBLY, circuit board—PULSE GENERATOR
	- - - - -			-	assembly includes:
	388-0897-00			1	BOARD, circuit
-42	131-0391-00			8	CONNECTOR, coaxial, one contact, male
-43	136-0183-00			1	SOCKET, transistor, 3 pin
-44	136-0220-00			14	SOCKET, transistor, 3 pin
-45	136-0235-00			2	SOCKET, transistor, 6 pin
-46	200-0687-01			1	COVER, plastic, transistor
-47	214-0506-00			23	CONNECTOR, square pin
-48	214-0579-00			4	CONNECTOR, test point
-49	344-0061-00			2	CLIP, diode
	- - - - -			-	mounting hardware for each: (not included w/assembly)
-50	211-0116-00			6	SCREW, sems, 4-40 x 5/16 inch, PHS
-51	343-0089-00			2	CLAMP, plastic, snap-in, large
-52	179-1213-00			1	CABLE HARNESS, trigger output

FIG. 3 CABINET

Fig. & Index No.	Tektronix Part No.	Serial/Model No. Eff	No. Disc	Q † y						Description
					1	2	3	4	5	
3-	437-0092-00			1						ASSEMBLY, cabinet
	- - - - -			-						assembly includes:
-1	426-0252-00			1						FRAME, front right
-2	426-0253-00			1						FRAME, front left
-3	377-0120-00			1						INSERT, frame right
-4	377-0121-00			1						INSERT, frame left
-5	426-0385-00			1						FRAME, section, bottom
	- - - - -			-						mounting hardware: (not included w/frame)
-6	212-0004-00			2						SCREW, 8-32 x 5/16 inch, PHS
-7	212-0002-00			2						SCREW, 8-32 x 1/4 inch, FHS
-8	426-0384-00			1						FRAME, section, top
	- - - - -			-						mounting hardware: (not included w/frame)
-9	212-0002-00			4						SCREW, 8-32 x 1/4 inch, FHS
-10	351-0092-00			1						GUIDE, right
-11	390-0015-00			1						CABINET, bottom
-12	351-0093-00			1						GUIDE, left
	- - - - -			-						mounting hardware: (not included w/guide)
	210-0005-00			1						LOCKWASHER, external, #6
-13	211-0510-00			1						SCREW, 6-32 x 3/8 inch, PHS
-14	348-0073-00			2						FOOT, left front, right rear
	- - - - -			-						mounting hardware for each: (not included w/foot)
-15	211-0532-00			2						SCREW, 6-32 x 3/4 inch, FHS
-16	348-0074-00			2						FOOT, right front, left rear
	- - - - -			-						mounting hardware for each: (not included w/foot)
-17	211-0532-00			2						SCREW, 6-32 x 3/4 inch, FHS
-18	377-0119-00			4						INSERT, rubber
-19	348-0120-00			2						FLIP STAND, cabinet
-20	358-0294-01			1						BUSHING, plug-in right
	- - - - -			-						mounting hardware: (not included w/bushing)
-21	211-0510-00			1						SCREW, 6-32 x 3/8 inch, PHS
	210-0005-00			1						LOCKWASHER, external, #6
-22	210-0457-00			1						NUT, keps, 6-32 x 5/16 inch
	210-0007-00			1						LOCKWASHER, external, #8
-23	212-0001-00			1						SCREW, 8-32 x 1/4 inch, PHS
-24	358-0293-01			1						BUSHING, plug-in left
	- - - - -			-						mounting hardware: (not included w/bushing)
	210-0007-00			1						LOCKWASHER, external, #8
-25	212-0001-00			1						SCREW, 8-32 x 1/4 inch, PHS
-26	367-0050-00			1						PIVOT, handle, right
	- - - - -			-						mounting hardware: (not included w/pivot)
-27	214-0554-00			1						HINGE BOLT, 10-32 x 0.468 inch, HHS
-28	214-0558-00			1						WASHER, thrust, 5/16 ID x 1/2 inch OD

FIG. 3 CABINET (cont)

Fig. & Index No.	Tektronix Part No.	Eff Serial/Model	Disc No.	Q					Description
				t	1	2	3	4	
3-29	377-0122-00			1					INSERT, decorative
-30	367-0080-00			1					HANDLE, carrying
	- - - - -			-					mounting hardware: (not included w/handle)
-31	212-0040-00			2					SCREW, 8-32 x 3/8 inch, FHS
-32	200-0076-00			1					COVER, plastic
-33	367-0051-00			1					PIVOT, handle, left
	- - - - -			-					mounting hardware: (not included w/pivot)
-34	214-0554-00			1					HINGE BOLT, 10-32 x 0.468 inch, HHS
-35	214-0558-00			1					WASHER, thrust, 5/16 ID x 1/2 inch OD
-36	377-0123-00			1					INSERT, decorative
-37	386-0141-00			2					PLATE, side
	- - - - -			-					mounting hardware for each: (not included w/plate)
-38	212-0002-00			2					SCREW, 8-32 x 1/4 inch, FHS
-39	348-0075-00			2					FOOT, rear guard
	- - - - -			-					mounting hardware for each: (not included w/foot)
-40	212-0039-00			2					SCREW, 8-32 x 3/8 inch, THS
-41	426-0386-00			1					FRAME, cabinet rear
-42	390-0014-00			1					CABINET, top

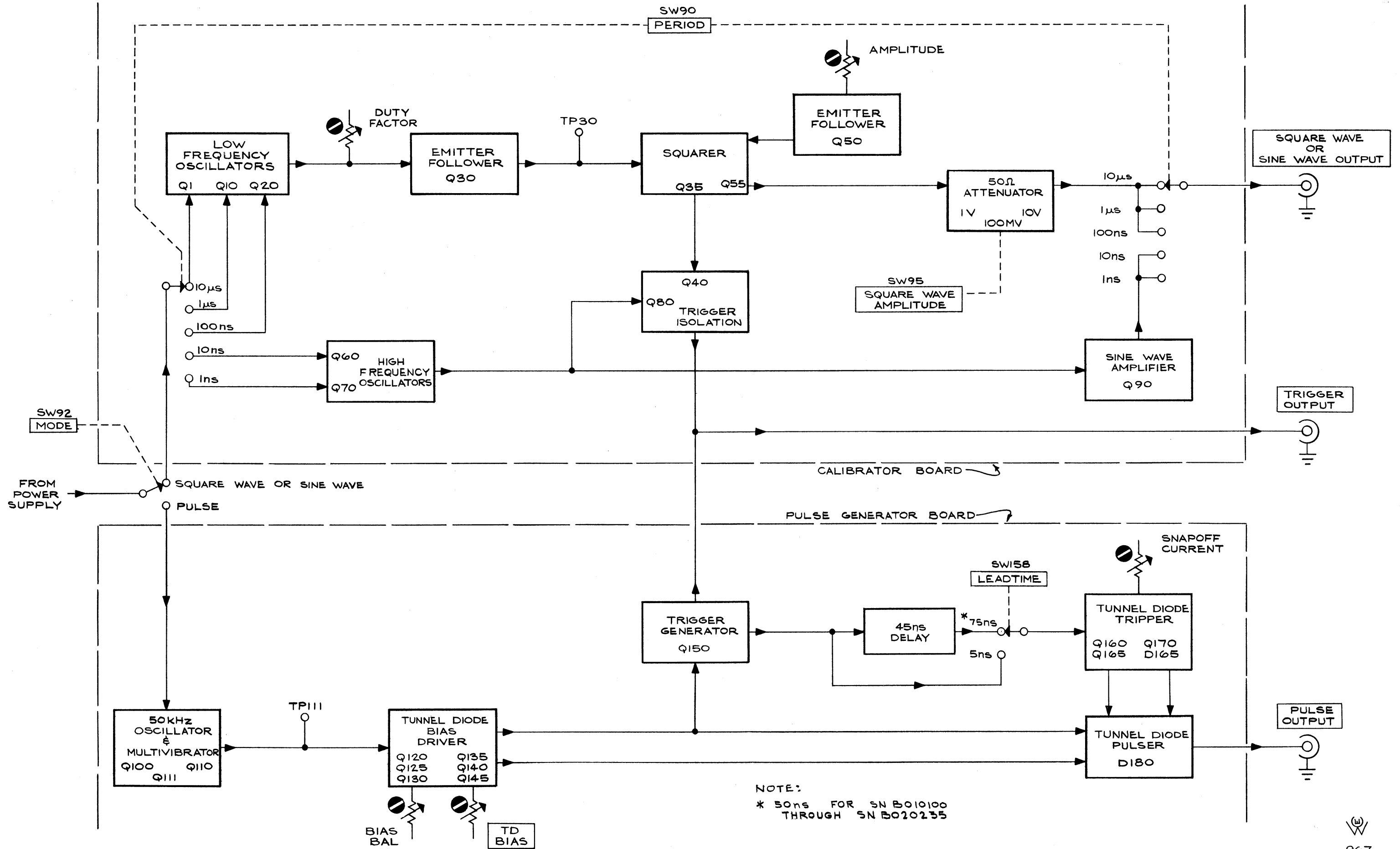

NOTE:
 * 50ns FOR SN B010100
 THROUGH SN B020235

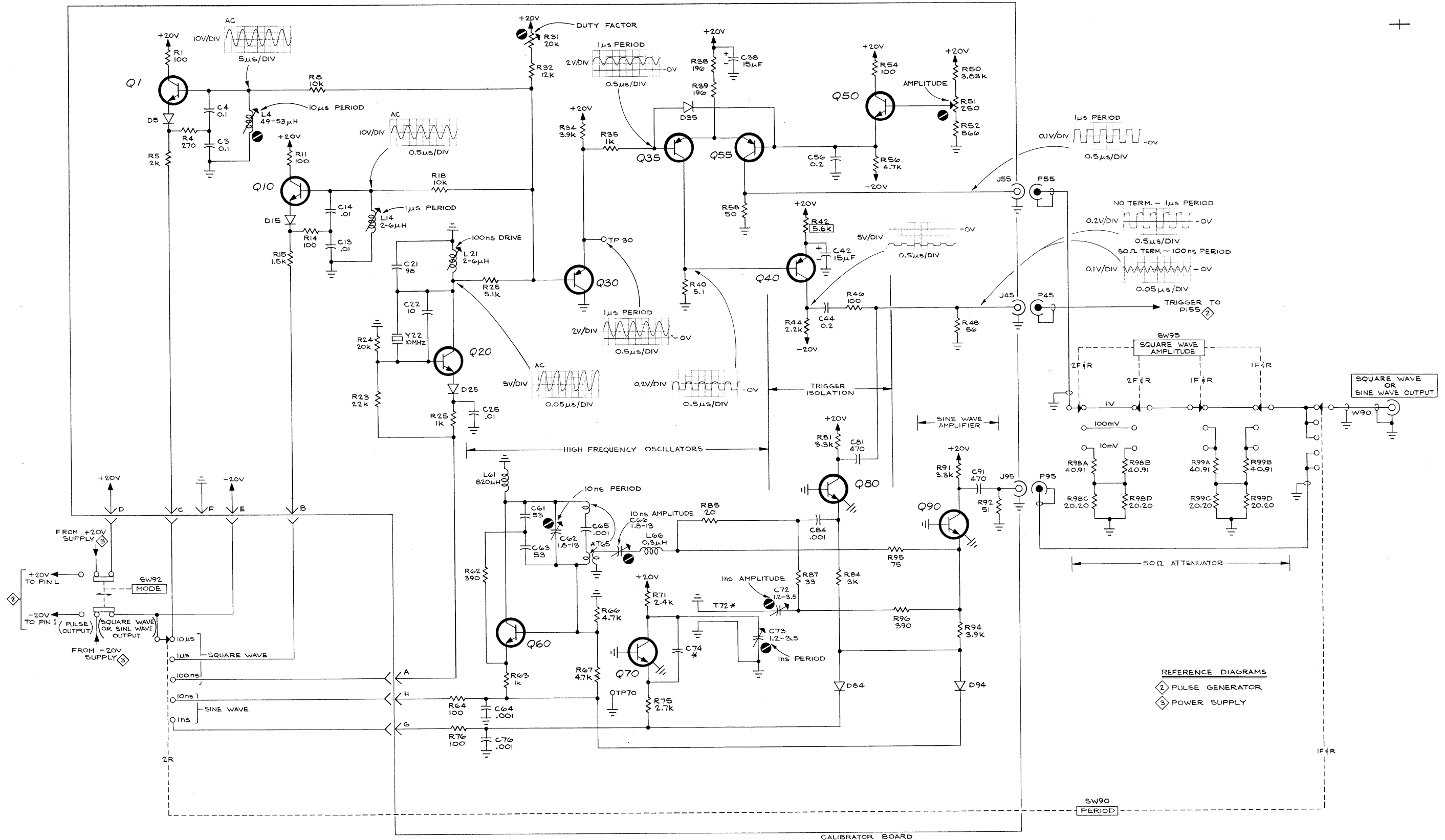

PERIOD GENERATORS 1

NOTE:
 1. SEE PARTS LIST FOR SEMICONDUCTOR TYPES
 2. * DENOTES PART OF ETCHED CIRCUIT BOARD

All WAVEFORMS on this diagram were taken with 85MHz oscilloscope with a 10X probe.

TYPE 284 PULSE GENERATOR

PERIOD GENERATORS & SWITCHING 1

0370

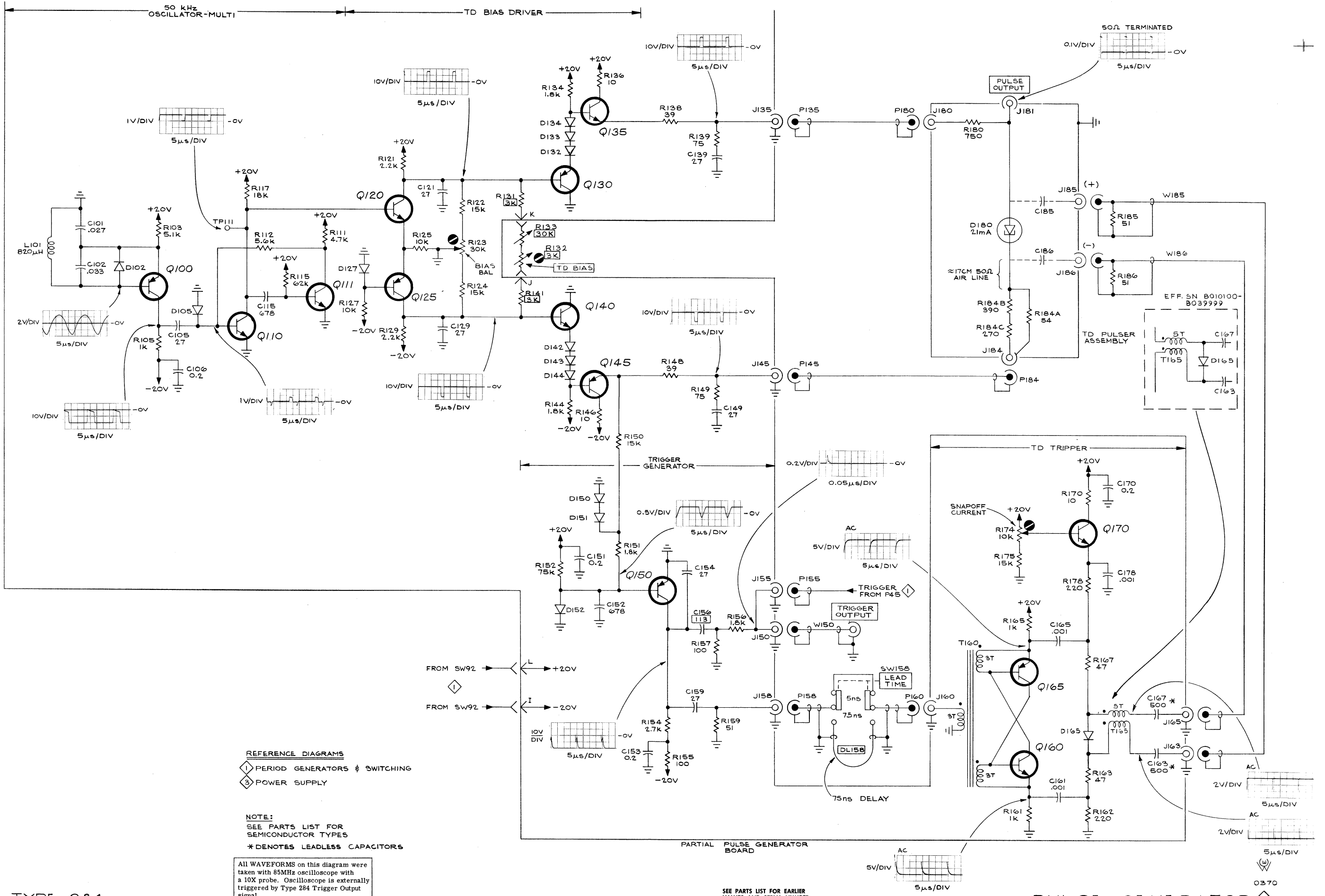

REFERENCE DIAGRAMS
 1 PERIOD GENERATORS & SWITCHING
 3 POWER SUPPLY

NOTE:
 SEE PARTS LIST FOR SEMICONDUCTOR TYPES
 * DENOTES LEADLESS CAPACITORS

All WAVEFORMS on this diagram were taken with 85MHz oscilloscope with a 10X probe. Oscilloscope is externally triggered by Type 284 Trigger Output signal.

SEE PARTS LIST FOR EARLIER VALUES AND SERIAL NUMBER RANGES OF PARTS MARKED WITH BLUE OUTLINE.

TYPE 284

PULSE GENERATOR 2

PULSE GENERATOR 2

0370

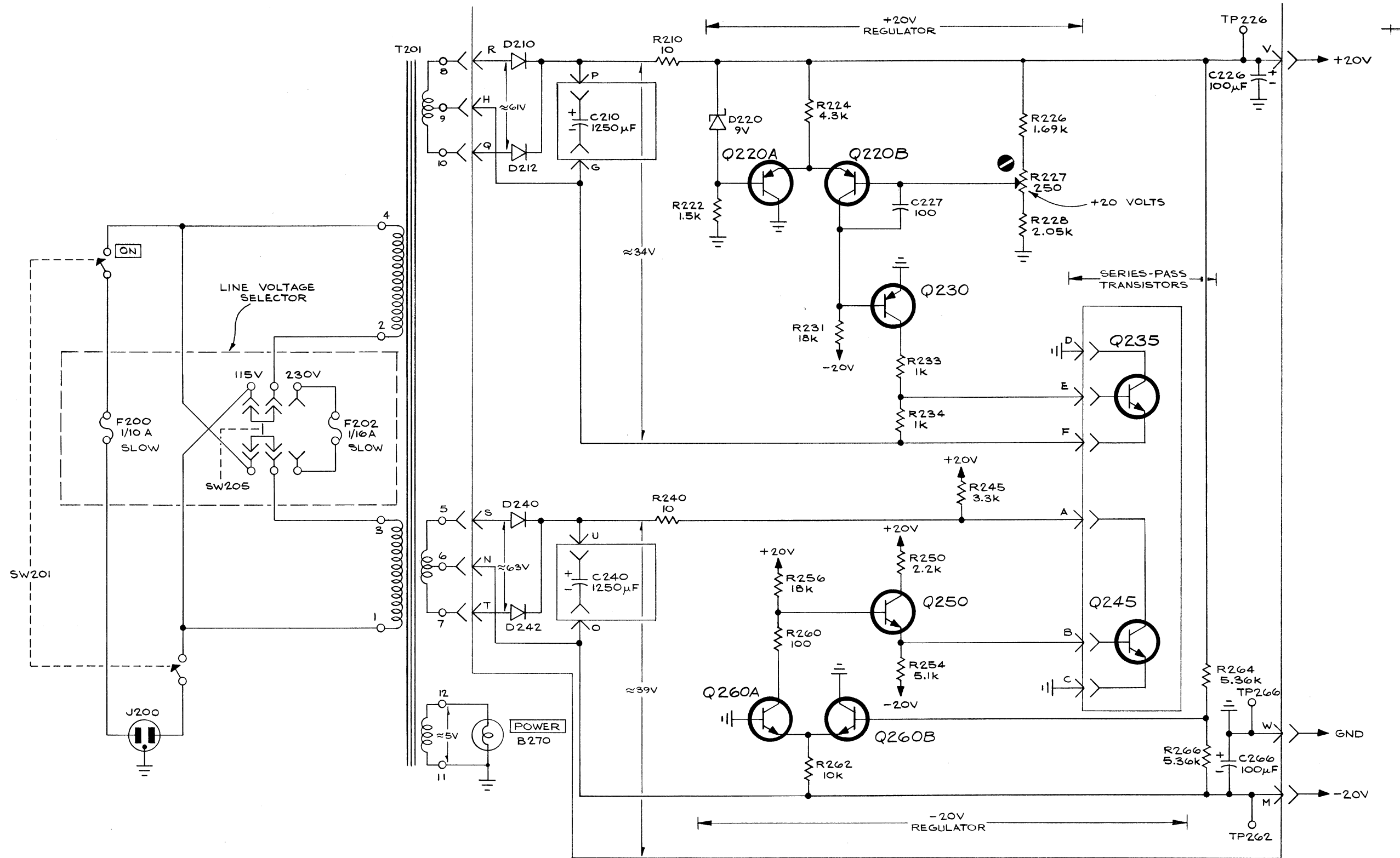

SEE PARTS LIST FOR SEMICONDUCTOR TYPES

PARTIAL PULSE GENERATOR BOARD

TYPE 284 PULSE GENERATOR

A

POWER SUPPLY

967

FIG. 1 FRONT & REAR

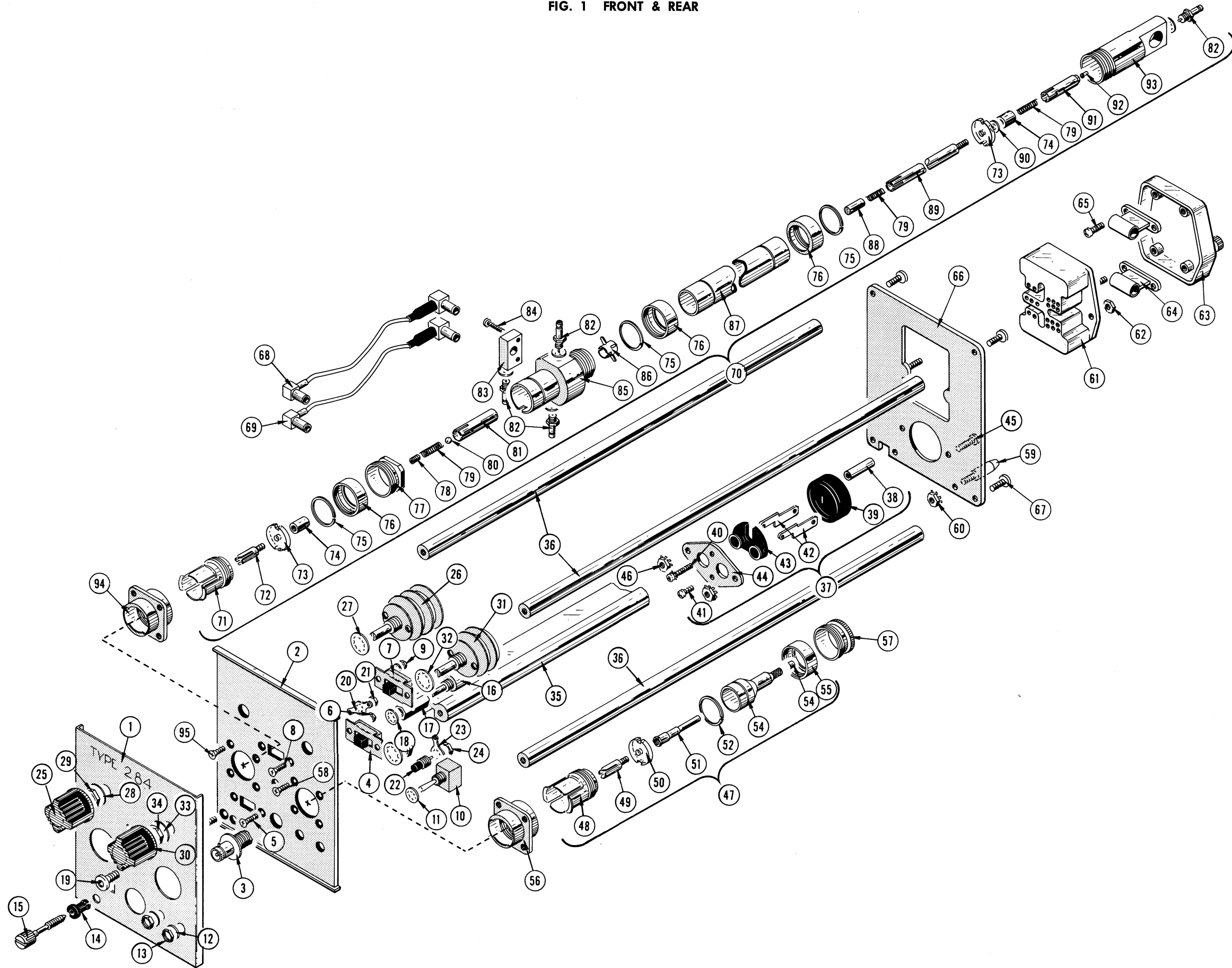

TYPE 284 PULSE GENERATOR

FIG. 1

FIG. 2 CHASSIS, CIRCUIT BOARDS & DELAY LINE

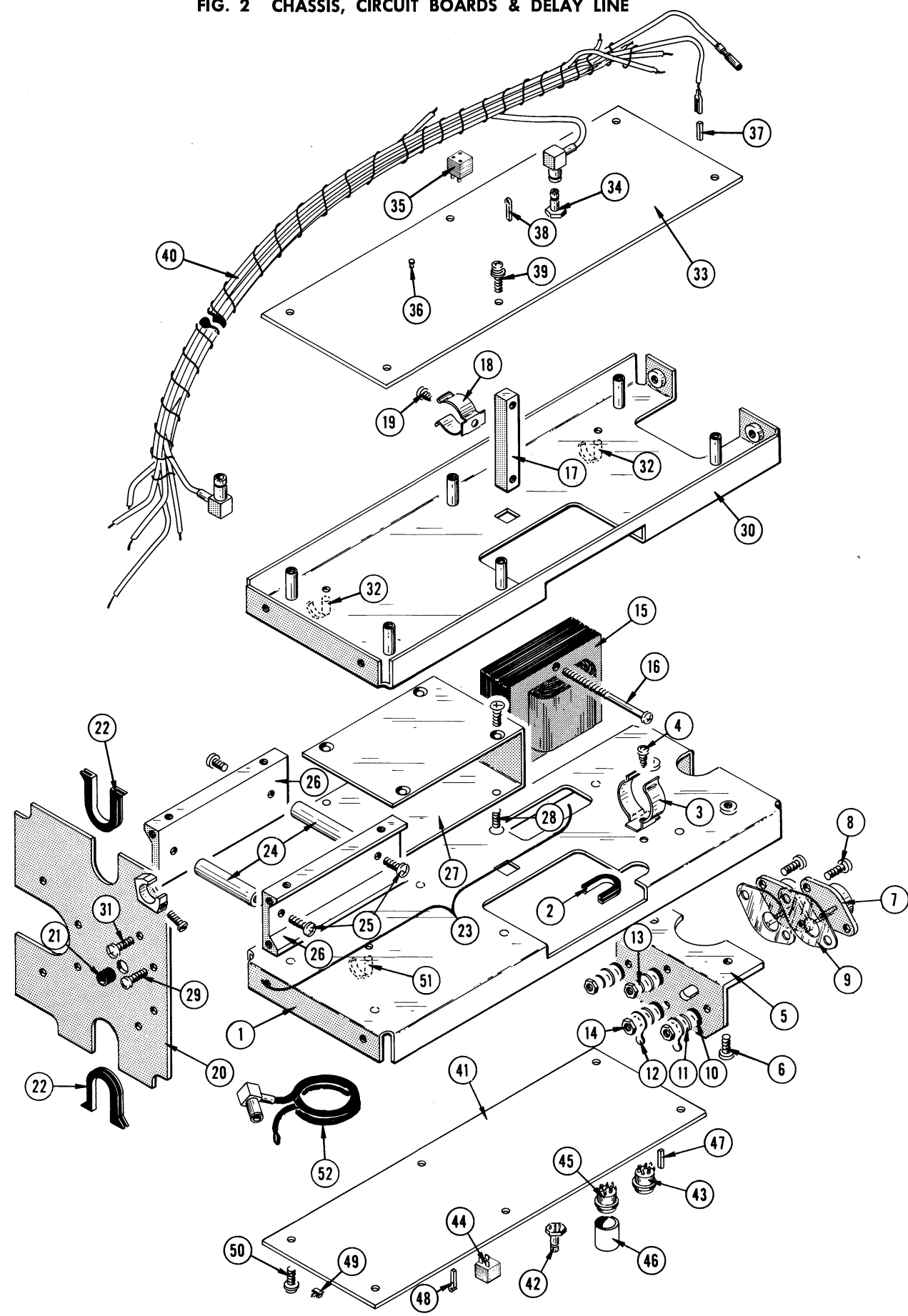

FIG. 2

FIG. 3 CABINET

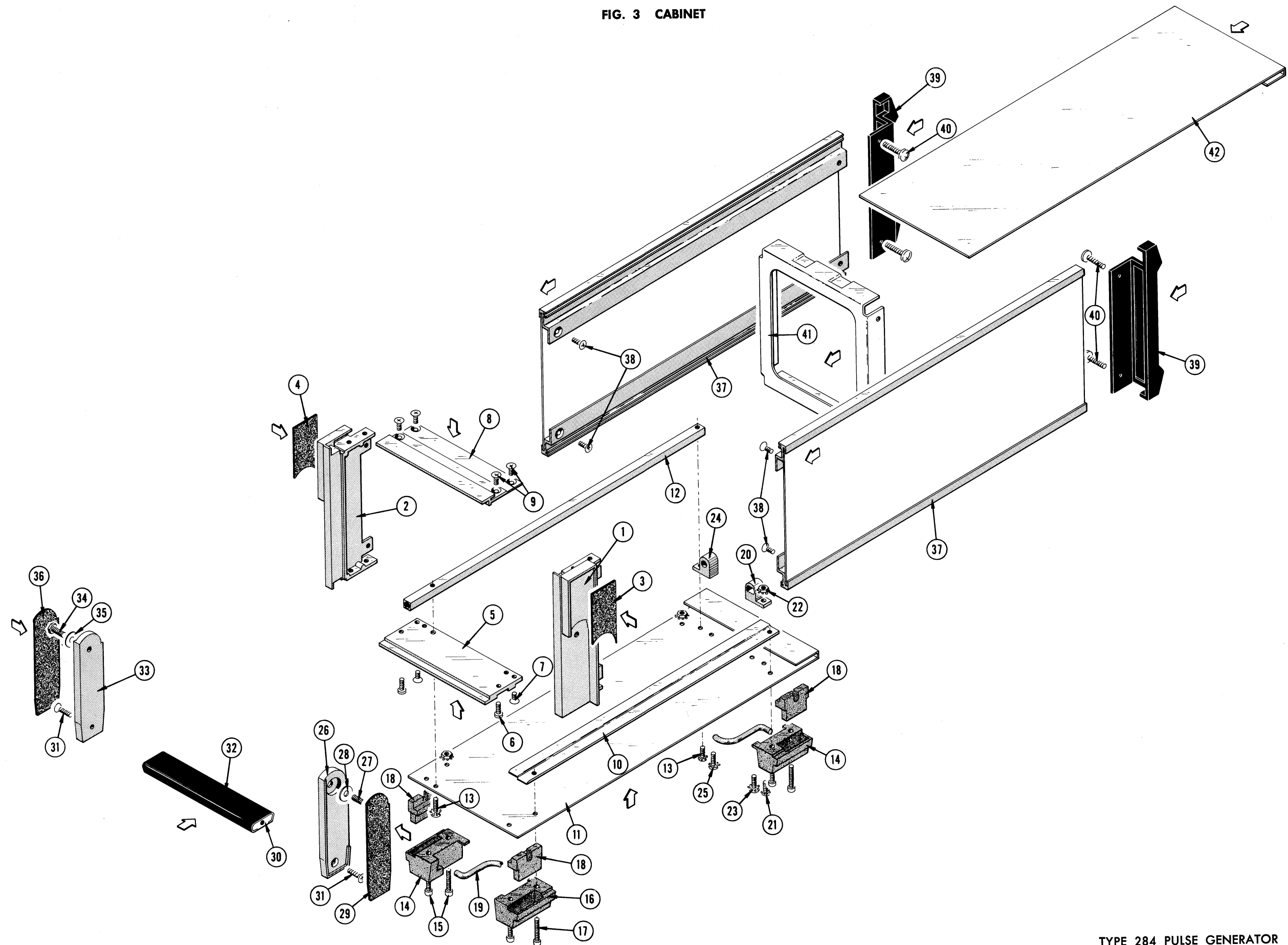

FIG. 3

TYPE 284 PULSE GENERATOR

FIG. 4 STANDARD ACCESSORIES

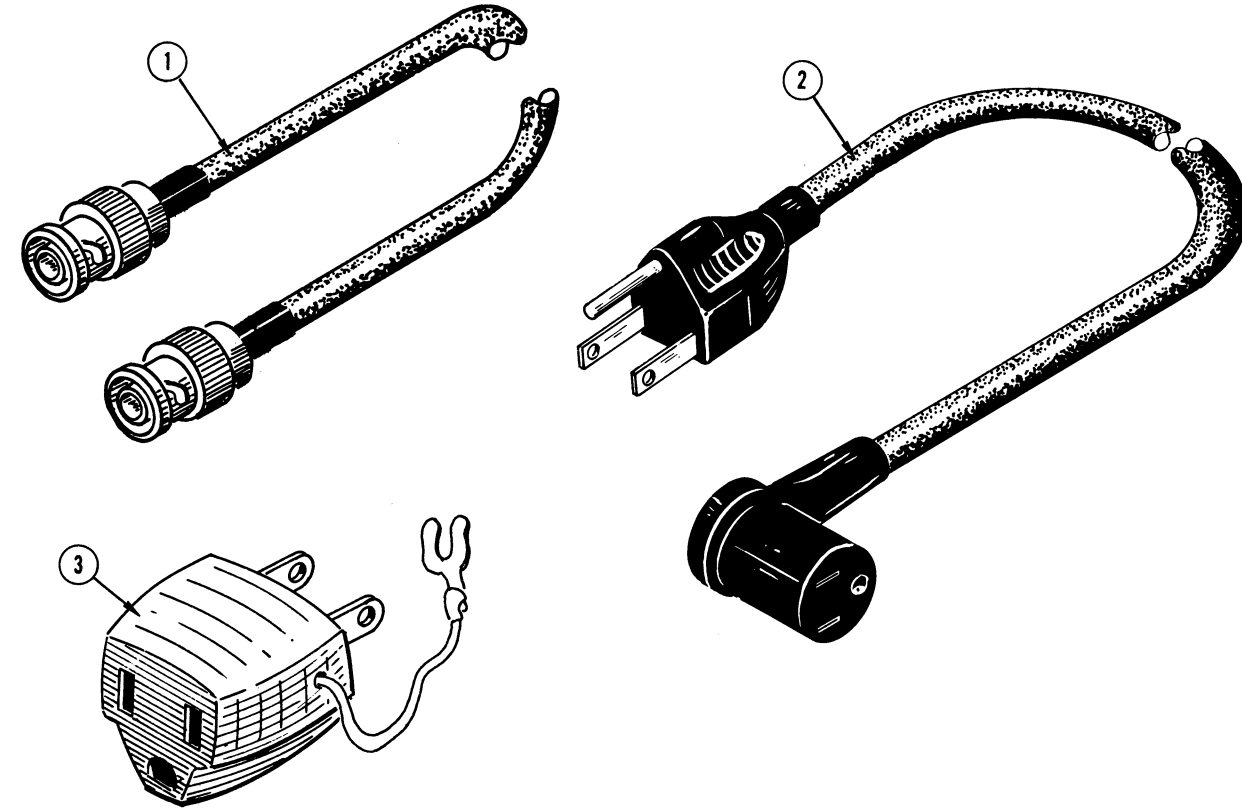

Fig. & Index No.	Tektronix Part No.	Serial/Model No.		Q † y	Description
		Eff	Disc		
4-1	012-0057-01			1	CABLE ASSEMBLY, 50 Ω coaxial w/BNC connector
-2	161-0024-01	B010100	B029999	1	CORD, power, 3 conductor, 8 foot, right angle
	161-0024-03	B030000		1	CORD, power, 3 conductor, 8 foot, right angle
-3	103-0013-00			1	ADAPTER, power cord 3 wire to 2 wire
	070-0754-00			2	MANUAL, instruction (not shown)

Ⓟ

▲

MANUAL CHANGE INFORMATION

At Tektronix, we continually strive to keep up with latest electronic developments by adding circuit and component improvements to our instruments as soon as they are developed and tested.

Sometimes, due to printing and shipping requirements, we can't get these changes immediately into printed manuals. Hence, your manual may contain new change information on following pages.

A single change may affect several sections. Sections of the manual are often printed at different times, so some of the information on the change pages may already be in your manual. Since the change information sheets are carried in the manual until ALL changes are permanently entered, some duplication may occur. If no such change pages appear in this section, your manual is correct as printed.

TYPE 284

PARTS LIST CORRECTION

Section 8 Mechanical Parts List

Fig. & Index No. 1-37

Page 8-2

CHANGE TO: 131-0102-02 1 ASSEMBLY, motor base

ADD: 337-0955-00 1 Shield, motor base

C1/1167

TEXT CORRECTION

Section 6 Calibration
Pages 6-1 & 6-3 Equipment Required

DELETE: Items 7, 8 and 9.

ADD: 7. Sampling oscilloscope. Dual trace, risetime 50 ps.
 Tektronix Type 561B with Type 3S2 (with S-2 Plug-In Sampling
 Head) and Type 3T2 Plug-In Units recommended. (Not shown.)

CHANGE: Items numbered 10 through 31 to read 8 through 29, respectively.

CHANGE: the new item 19 to read as follows:

 19. 50 Ω precision resistor, \pm .1%. Tektronix Type 067-0515-00
 is recommended. (Not shown.)

CHANGE: The second sentence of item 21 to read:

 Tektronix Part No. 017-0513-00.

ADD: Item 30 as follows:

 30. Type VP-2 Voltage Pickoff. (Not shown.)

Pages 6-2 & 6-3 Fig. 6-1 & 6-2

CHANGE: Figures 6-1 and 6-2 accordingly.

TEXT CORRECTION

Section 6 Calibration

Page 6-5 left column

ADD: to Test Oscilloscope Type 545B with Type 1A1 control settings:

Amplitude Calibrator 1 mVolts

Connections

CHANGE: line 2 to read:

CH 1 Signal Out connector to the Input 2 connector. Con-

TEXT CORRECTIONS

Section 2 Operating Instructions

Page 2-7 First Column

ADD: the following note after the first paragraph under the heading Pulse Output:

NOTE

An internal TD Bias adjustment (R133) is provided for coarse adjustment of tunnel diode bias. If the tunnel diode is replaced or if the front panel control doesn't provide a satisfactory setting adjust the TD bias (internal) in the manner given in the Calibration section of this manual.

Section 4 Maintenance

Page 4-8 Fig. 4-7

REPLACE: the present photo with the one included in this insert, note the new location of D165.

Section 6 Calibration

Page 6-20 Fig. 6-25

REPLACE: the present photo with the one included in this insert, note the addition of the location of the Internal TD Bias adjustment (R133).

CHANGE: the heading of Step 15 to read:

15. Adjust TD Bias (internal)

REPLACE: the first sentence of Step 15(c) with the following:

c. Adjust the front panel TD BIAS control (R132) to its approximate midrange position. Adjust the internal TD Bias adjustment (R133) for a trace similar to that shown in Fig. 6-26A.

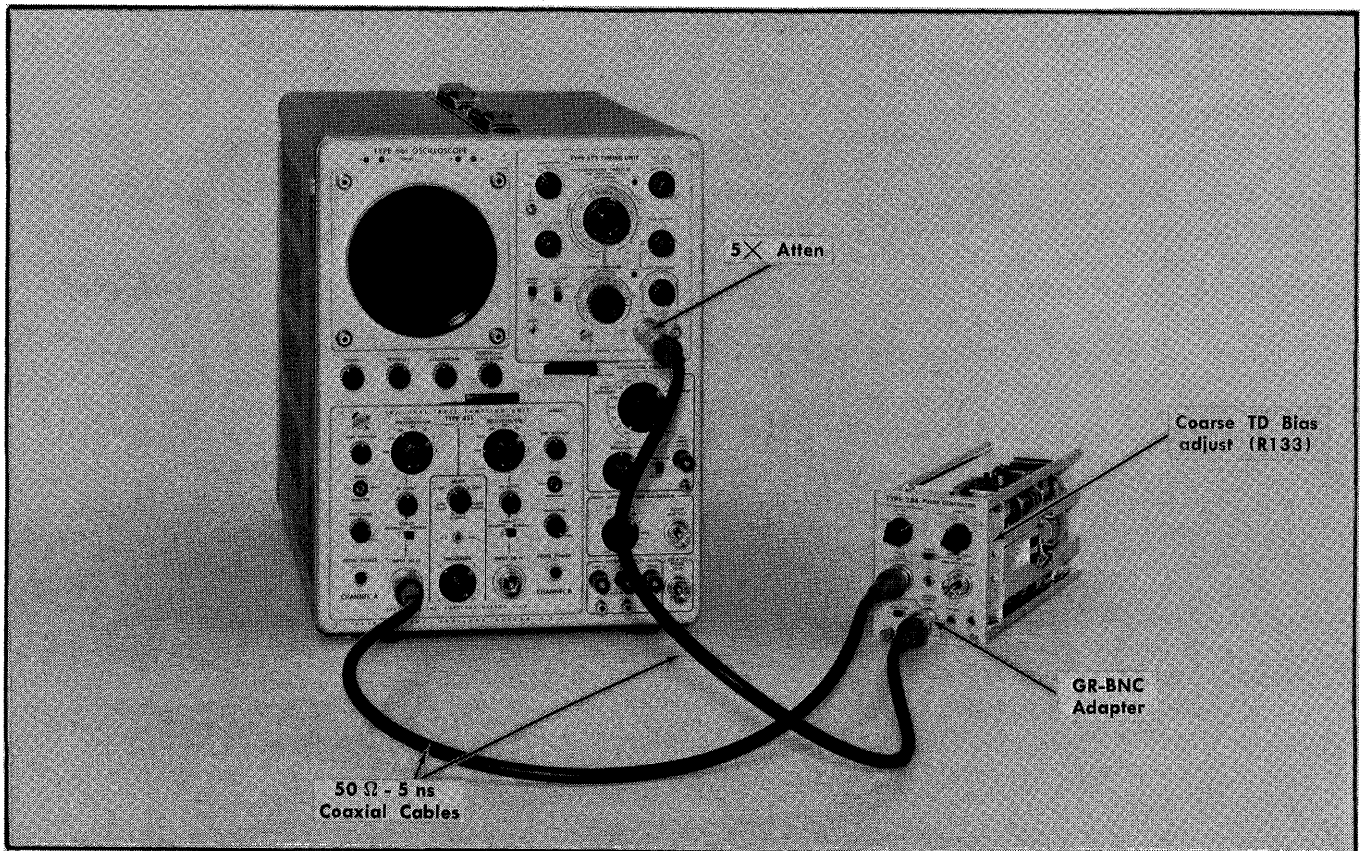

Fig. 6-25. Equipment setup for steps 15 through 24.

ELECTRICAL PARTS LIST AND SCHEMATIC CORRECTIONS

CHANGE TO:

R131	301-0302-00	3 k Ω	1/2 W	5%
R132	311-0629-00	3 k Ω , Var		
R141	301-0302-00	3 k Ω	1/2 W	5%

ADD:

R133	311-0487-00	30 k Ω , Var		
------	-------------	---------------------	--	--

SCHEMATIC CORRECTIONS

PARTIAL-
PULSE
GENERATOR 2

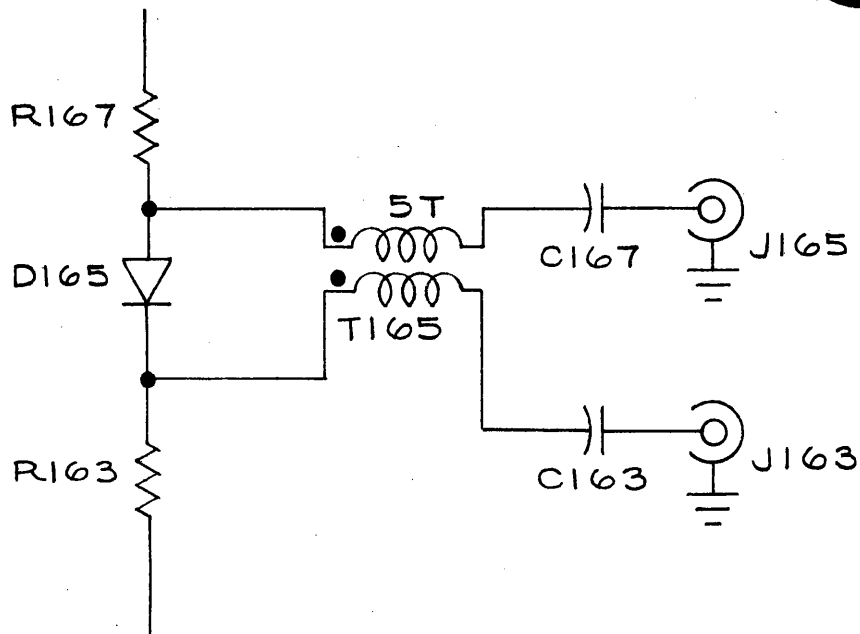
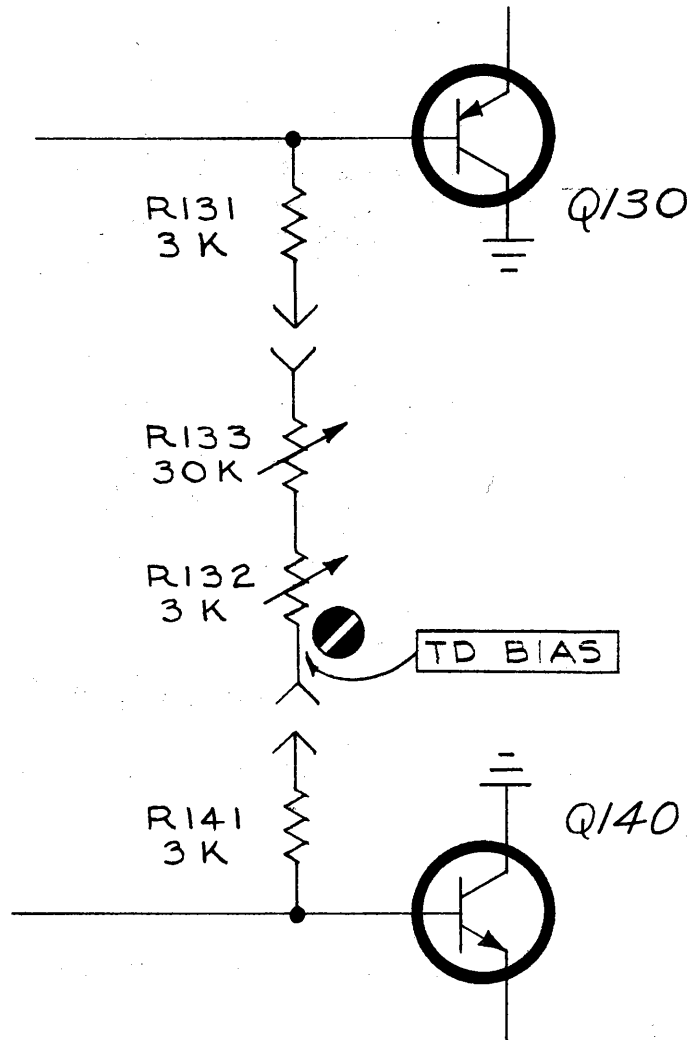

TYPE 284

TENT SN B060600

ELECTRICAL PARTS LIST CORRECTION

CHANGE TO:

SW90

260-0883-01

Rotary

PERIOD

TYPE 284

TENT SN B060600

ELECTRICAL PARTS LIST CORRECTION

CHANGE TO:

R42

301-0562-00

5.6 k Ω

1/2 W

5%

M15,895/170

TYPE 284

ELECTRICAL PARTS LIST AND SCHEMATIC CORRECTIONS

CHANGE TO:

C163	283-0121-00	0.001 μ F	200 V
C167	283-0121-00	0.001 μ F	200 V