

LUBRICATION KIT



INSTRUCTIONS

Copyright © new material copyright 1965 and 1968, by Tektronix, Inc. Beaverton, Oregon. Printed in the United States of America. All rights reserved. Contents of this publication may not be reproduced in any form without permission of the copyright owner.

COMPONENT LUBRICATION KIT 003-0342-01

CONTENTS

- 1 ea - NO NOISE, Pressurized can, 006-0442-00
- 1 ea - WD-40, Pressurized can, 006-0172-00
- 1 ea - G.E. VERSILUBE G305M, Silicon grease, 006-1353-00 01
- *1 ea - Detent lubricant, container-applicator, 006-0219-00
- 12 ea - Detent balls, replacement, 5/32 in. diameter, 214-0493-00
- 12 ea - Detent balls, replacement, 3/16 in. diameter, 214-0494-00
- 12 ea - Detent balls, replacement, 7/32 in. diameter, 214-0593-00
- 12 ea - Detent, roller, replacement, 0.125 in. OD, 214-1127-00
- 1 ea - Brush #1, 003-0016-00
- 1 ea - Instruction booklet, 070-0496-01

*The container applicator stem is sealed for shipment. Remove red tip cap, and cut off about 1/8 inch of stem end.

TEKTRONIX
COMPONENT LUBRICATION KIT
FOREWORD

Components used in the manufacture of Tektronix Instruments are chosen because of their long life and reliable performance. Prior to shipment from the factory, your instrument was thoroughly inspected to assure all components requiring lubrication were properly and adequately lubricated.

The component lubrication kit contains materials and information to aid you in maintaining the lubrication requirements of your instrument as a part of your routine maintenance program.

If you desire additional information your Tektronix Field Engineer will be glad to discuss your individual maintenance needs with you

COMPONENT LUBRICATION

INSTRUCTIONS

GENERAL INFORMATION. Page 2

SWITCHES

Rotary	4
Turret	11
Cam	12

MISC

Pushbutton	16
Slide	16
Toggle	16

POTENTIOMETERS

Commercial	17
Tektronix	18

FAN MOTORS 19

AIR FILTERS 20

RACKMOUNT TRACKS 21

COMPONENT LUBRICATION

GENERAL INFORMATION

To assure the maximum service from your Tektronix instrument, it should be kept clean and properly lubricated. Some of the questions often asked about cleaning and lubrication are . . .

HOW DO YOU CLEAN AN INSTRUMENT?

Depending on the condition of the instrument, one of two methods should be used:

1. AIR The instrument should be thoroughly blown out with air. The filter should be cleaned and replaced.
2. WASH Tektronix Repair Centers use an instrument wash procedure as part of their repair-recalibration service. Your Field Engineer will be glad to give you full details on this service or information on setting up a wash operation at your maintenance facility.

HOW OFTEN SHOULD AN INSTRUMENT BE CLEANED?

This depends on the operating conditions and the instrument's environment. Generally, the instrument should be cleaned with air and have the filter changed or cleaned at the time of recalibration. An instrument wash should be considered any time the air technique fails to thoroughly clean the instrument.

COMPONENT LUBRICATION

GENERAL INFORMATION (continued)

WHEN DOES AN INSTRUMENT REQUIRE LUBRICATION?

1. Anytime an instrument is washed, the components should be completely lubricated as outlined in this booklet.
2. At the time of recalibration, the instrument should be inspected for signs of components needing lubrication. It's usually a good practice to lubricate exposed switch detent mechanisms at this time. Other components may also need attention, depending on the instrument's condition and use.
3. Components requiring lubrication often show up in the form of mechanical or electrical noise. This booklet covers the components that may require attention.

ROTARY SWITCHES

The photo below will acquaint you with some of the parts of a rotary switch. These will be referred to in describing the lubricating procedures. The four switches most commonly used in our instruments are Types A, F, LK, and MF. The lubricating procedure for each is given in the following pages.

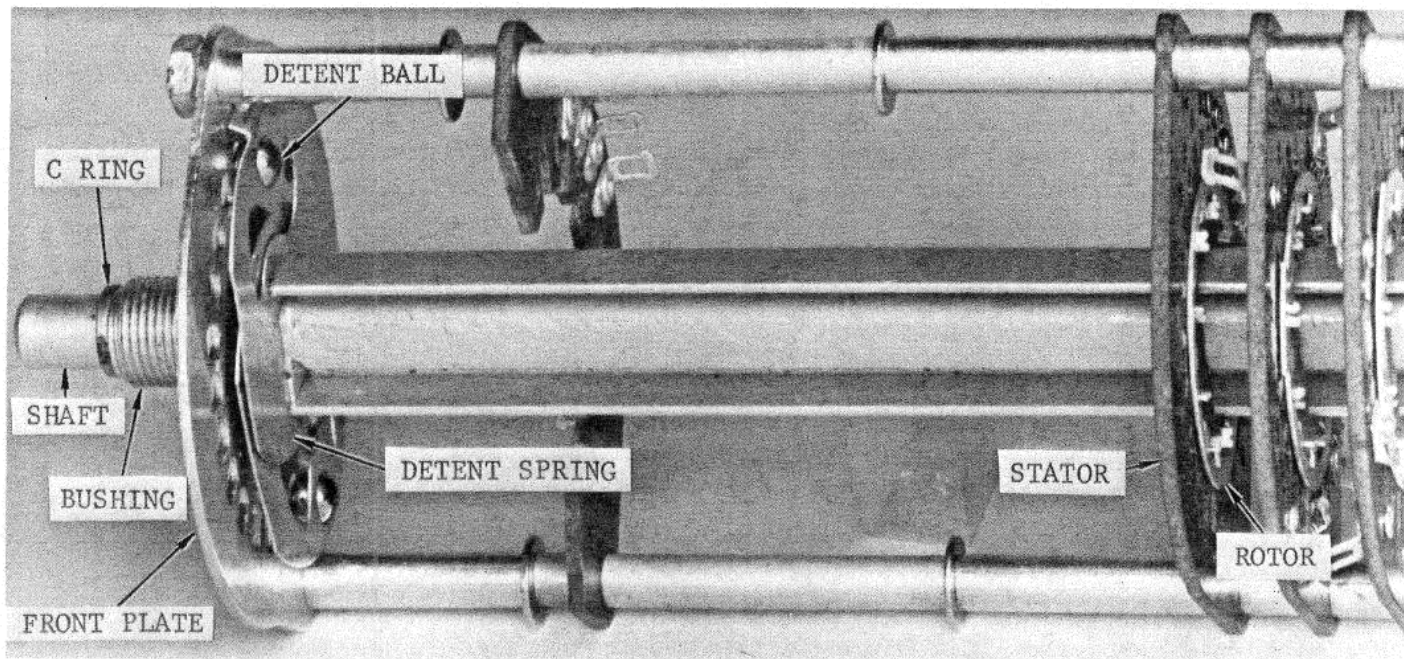

ROTARY SWITCHES

DETENT AND SHAFT LUBRICATION

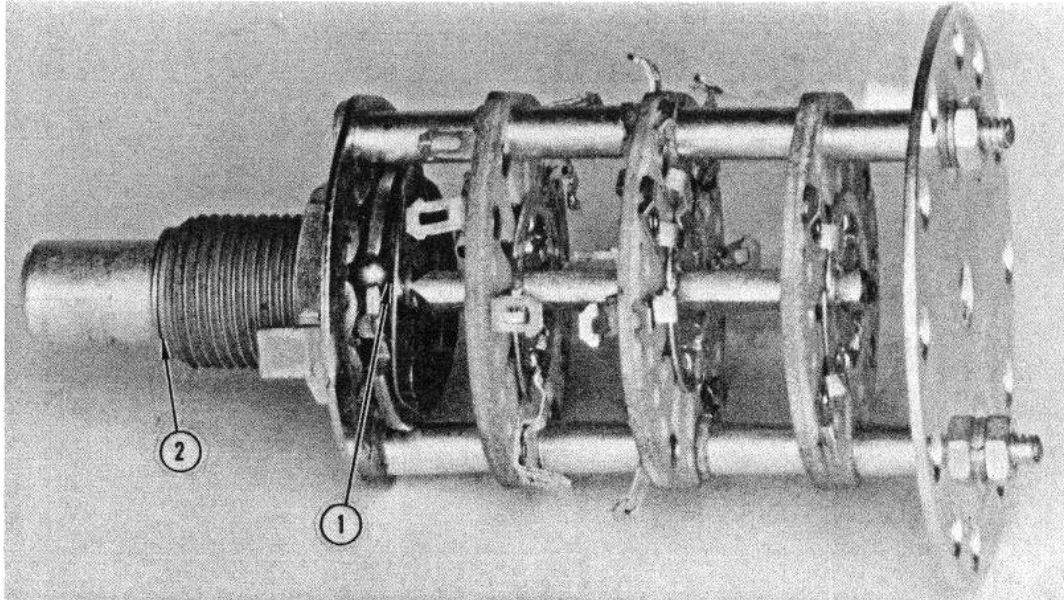

TYPE A

1. Apply DETENT LUBRICATING GREASE liberally between ball retainer and spring.
2. Apply WD-40 to shaft at front of bushing. Wipe away excess.

ROTARY SWITCHES

DETENT AND SHAFT LUBRICATION

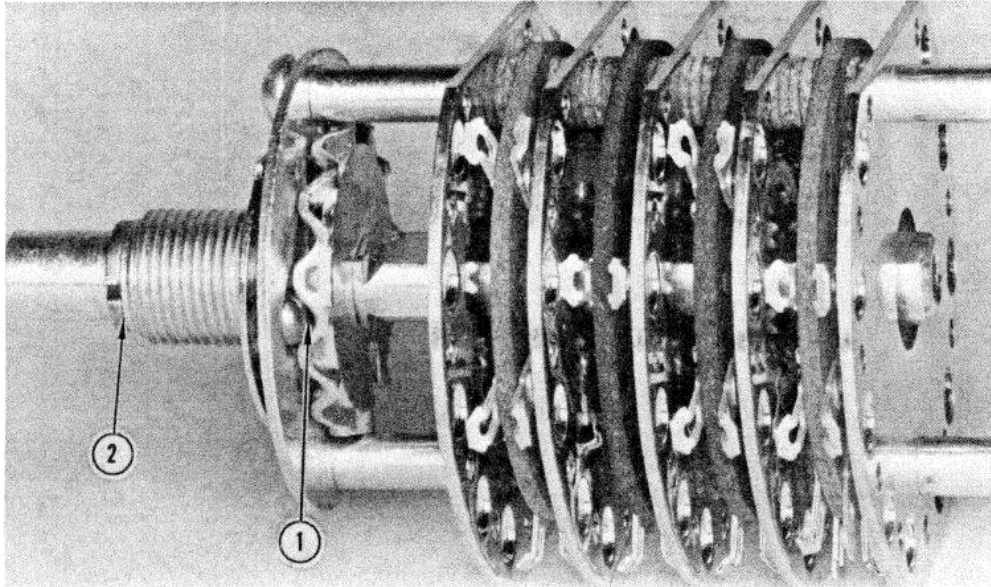

TYPE F

1. Apply DETENT LUBRICATING GREASE liberally between ball and index wheel.
2. Apply WD-40 to shaft at front of bushing. This is best done at point where ends of "C" ring meet. Wipe away excess.

ROTARY SWITCHES
DETENT AND SHAFT LUBRICATION

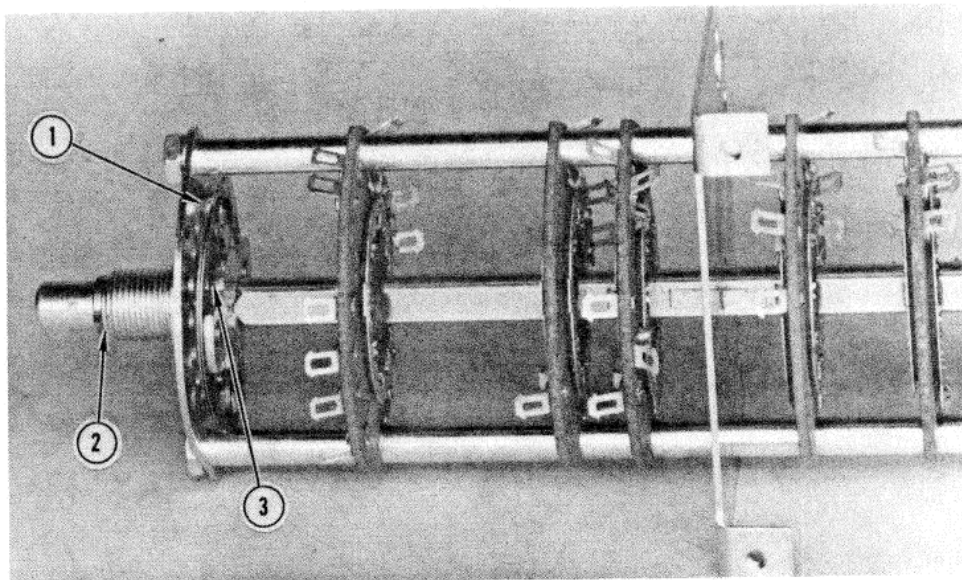

TYPE LK

1. Apply DETENT LUBRICATING GREASE liberally between each detent ball and spring. Apply grease sparingly to detent plate, lightly coating path that the balls will travel.
2. Apply WD-40 to shaft at front of bushing. Wipe away excess.
3. Apply WD-40 sparingly to shaft between detent spring and front plate.

ROTARY SWITCHES
DETENT AND SHAFT LUBRICATION

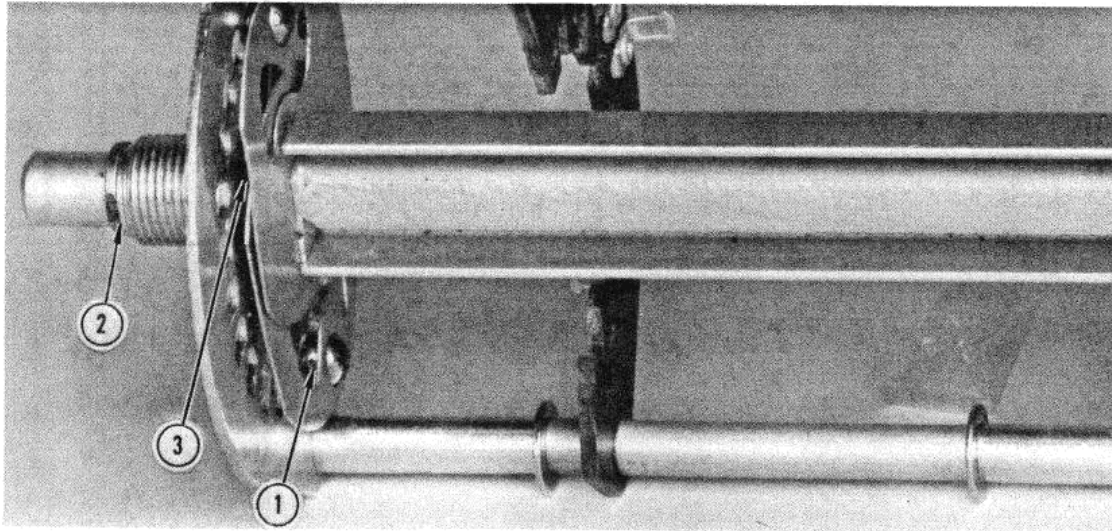

TYPE MF

1. Apply DETENT LUBRICATING GREASE liberally between each detent ball and spring. Apply grease sparingly to detent plate, lightly coating path that the balls will travel.
2. Apply WD-40 to shaft at front of bushing. Wipe away excess.
3. Apply WD-40 sparingly to shaft between detent spring and front plate.

ROTARY SWITCHES

DETENT BALL REPLACEMENT

Detent mechanisms of the "non-captive" type have, on occasion, "dropped the ball". This usually occurs because of a dry or poorly lubricated mechanism. Three sizes of detent balls are included in the kit. Switch Types LK and MF use a 3/16 inch ball. The Type F switch uses a 5/32 inch ball.

Missing detent balls should be replaced by removing the "C" ring at the front of the bushing. This relieves the tension on the spring, allowing the ball to be clipped in place. If you are extremely careful, you can, in many cases, replace the ball by prying the spring back with a soldering aid or scribe. Care must be taken or the detent spring will be bent, lessening the tension required for normal detent action.

Dry or poorly lubricated detents using a "non-captive" 3/16 inch ball have occasionally lost the ball by its wearing through the detent spring. In this case a 7/32 inch oversize ball should be installed to accommodate the enlarged hole. Needless to say, the detent mechanism should be lubricated after the new ball is installed.

ROTARY SWITCHES ROTOR AND CONTACT LUBRICATION

Rotor and contact lubrication will help to reduce electrical noise and extend switch life. However, care should be exercised not to over lubricate this part of the switch, as excess oil will tend to hold dust particles that can become detrimental to switch performance. If the interior of an instrument contains dust or other foreign material, it is desirable that it be cleaned by one of the methods described on page 2 prior to switch lubrication.

There are a half dozen or more insulating materials commonly used in rotary switches assembled in Tektronix instruments. All may be lubricated in the same manner without resulting detrimental effects, if the NO NOISE contact restorer-lubricant is used according to the following applicable suggestions and procedures.

The nozzle extension tube provided with each can of NO NOISE should be used to direct this fluid when applying it to rotary switches. To free switch contacting surfaces of resistive oxides and at the same time amply lubricate them, spray onto each switch wafer side having contact clips, a quantity of NO NOISE that will wet the rotor blade and ends of clips. Immediately rotate the switch from stop to stop, to distribute the volatile vehicle before it evaporates. By so doing, an invisible film of protective lubricating oil is left on the contacting surfaces after vehicle evaporation.

When applying NO NOISE as just described, direct the spray toward wafer from two opposite angles if possible. Spraying should preferably be done from each side of the switch onto the same side of each wafer, to improve application to inner surfaces of rotor blades. When wetting the switch wafer with this contact restorer, spray surfaces until they appear wet, but not until they drip with excess fluid. Blot any excess immediately with clean soft cloth.

TURRET SWITCH LUBRICATION

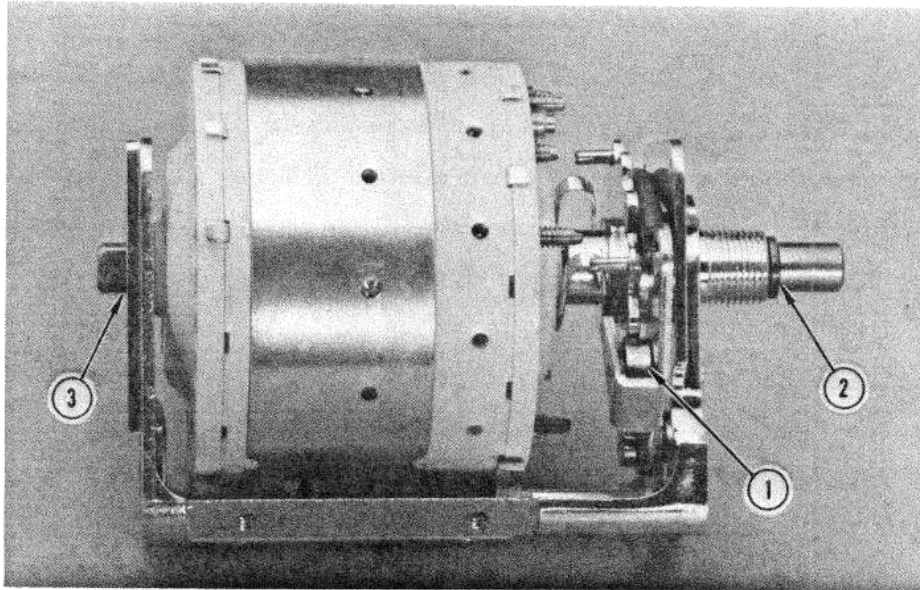

1. Oil both ends of detent roller and roller arm hinge pin with WD-40.
2. Oil shaft at front of bushing with WD-40.
3. Oil Shaft at rear of switch with WD-40.

NOTES: Omit step 1 if switch is late model having plastic detent wheel.

Turret switch contacts can be oiled with NO NOISE applied with small brush. Grease is unnecessary on turret switch detents.

CAM TYPE SWITCHES

In most cases the factory lubrication of the Cam Type Switch will be adequate for the life of the instrument. Even after an instrument has been washed, there should be no need for re-lubricating this type of switch provided some reasonable precautions have been taken during wash as spelled out in the recommended wash operation procedure.

If cleaning methods other than the recommended wash operation are used, i.e., ultrasonics, etc.; the factory lubrication may be removed and therefore the switches would have to be re-lubricated. Contact your Tektronix Field Engineer if you have any questions.

The following lubrication information then, will usually only be required if the switch has been disassembled for replacement of switch sub-parts.

CAM TYPE SWITCHES (cont)

Switch lubricant should be used on these switches and applied sparingly so that the lubricant does not get on contact surfaces.

1. Apply lubricant to drum journals and mating surface in mounting bearings.
2. Apply lubricant to wear surface of index wheel.
3. Apply lubricant to index roller and roller guide in front bearing. A thin film should be applied to interface of detent springs if more than one spring is used.
4. Some lubricant should be present at interface of bearing and retaining ring.
5. Contacts in this type switch should not be lubricated.

GAM TYPE SWITCHES (cont)

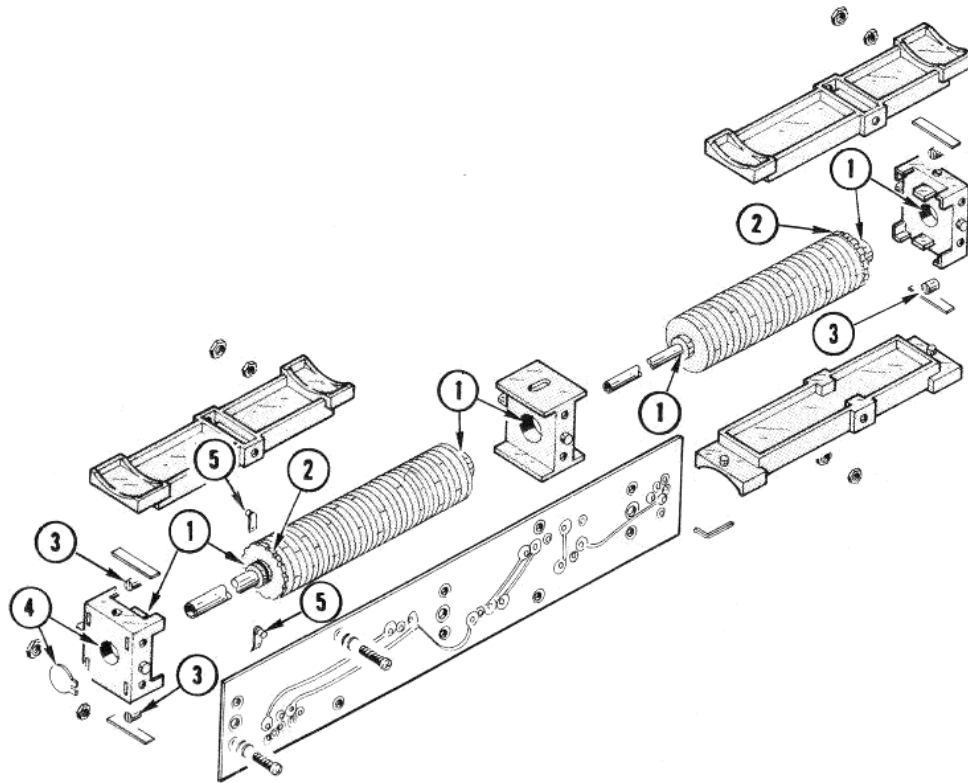

CAM TYPE SWITCHES (cont)

USE OF BEACON 325

Beacon 325, or other hydrocarbon lubricants, is not recommended for use around the 7000 Series cam switches. These lubricants attack the material in the cam switch side-rails.

Beacon 325 has been used in some plug-ins to hold the side-rail nuts in place prior to tightening. It is recommended that silicone grease, type G.E. Versilube G305M (Tektronix p/n 006-1353-00), be used to hold the nuts in place for tightening in lieu of Beacon 325.

MISCELLANEOUS SWITCHES

Generally, conventional pushbutton, slide and toggle switches do not require lubrication. They should be replaced if not functioning properly.

Special toggle and pushbutton switches utilizing exposed contact surfaces similar to rotor switches can be lubricated with NO NOISE. Wet contacts as described in paragraph 3, page 10, actuate switch a few times before vehicle evaporates, and blot away any excess.

Mechanical parts of these switches may be lubricated at the points of friction with WD-40 or lubricating grease as required.

POTENTIOMETERS

Commercially Manufactured

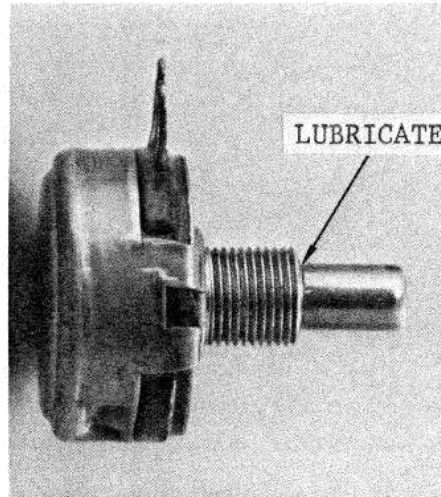

Lubricate the pot shaft at the front of the bushing, using the WD-40 supplied in the kit.

Potentiometers that do not utilize a sealed case can be treated for noise using the WD-40. Apply a drop of WD-40 at the terminal opening of the case. Rotate the shaft several times to assure complete internal coverage of the lubricant.

POTENTIOMETERS

Manufactured by Tektronix

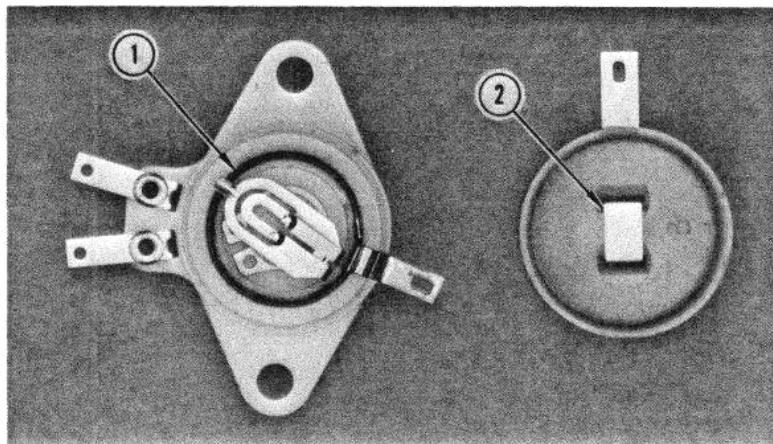

Pot noise can be lessened or in many cases, eliminated by applying the "No Noise" supplied in the kit. Also, pot "wear" is reduced considerably.

1. To lubricate, carefully remove the dust cover from the pot. Apply a small drop of "No Noise" in area of the wiper. Rotate the pot, making sure the lubricant covers the entire area of wiper travel.
2. Later style pots use a connector terminal in the dust cover. This terminal should also be lubricated. Be careful not to touch inner workings of the pot with a foreign material such as a rag or swab.

FAN MOTORS

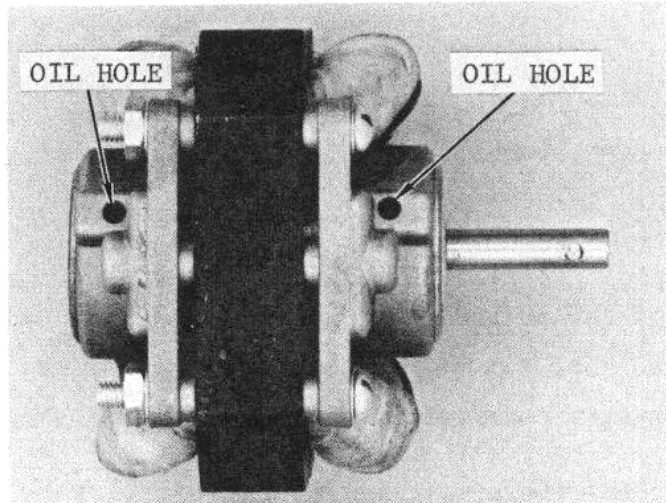

Some fan motors used in Tektronix instruments have permanently lubricated bearings and do not require lubrication. Others, like the type pictured above, do require occasional attention. Motors requiring lubrication are easily identified by the two oil holes at either end of the housing.

To lubricate, insert a couple of drops of WD-40 in each oil hole. Apply the lubricant sparingly. Many of the problems experienced with fan motors have resulted from over-lubrication.

RACKMOUNT TRACKS

Instruments of the Rackmount type may require occasional lubrication of the tracks. The sliding contact surfaces of the track should be lubricated using a commercially available lubrication stick such as "Door-Ease".

AIR FILTERS

Air filters are coated at the factory with a special water soluble oil. This coating collects dust particles from the air stream entering the instrument. The air filter should be inspected routinely for an excessive build-up of dirt. A neglected air filter will reduce the air flow required for normal cooling of your instrument.

To clean and re-oil, remove the filter from the instrument and wash in warm water. After the filter is thoroughly dry, recoat the outside surface with a water soluble filter coat, such as Tektronix P/N 006-0580-00 or 006-0457-00.

**TEKTRONIX®**committed to
technical excellence**MANUAL CHANGE INFORMATION**TITLE Lubrication KitCHANGE REFERENCE C1/677070-0496-01DATE June 30, 1977**CHANGE:****DESCRIPTION**

COMPONENT LUBRICATION KIT 003-0342-01

CONTENTS

DELETE: 1 ea - NO NOISE, Pressurized can, 006-0442-00

CHANGE TO: 1 ea - WD-40, Pressurized can, 006-2574-00