

Tekniques

The 4050 Series Applications Library Newsletter

February 1, 1981

Vol. 5 No. 1

4051 Tests Navigational Satellite Clock

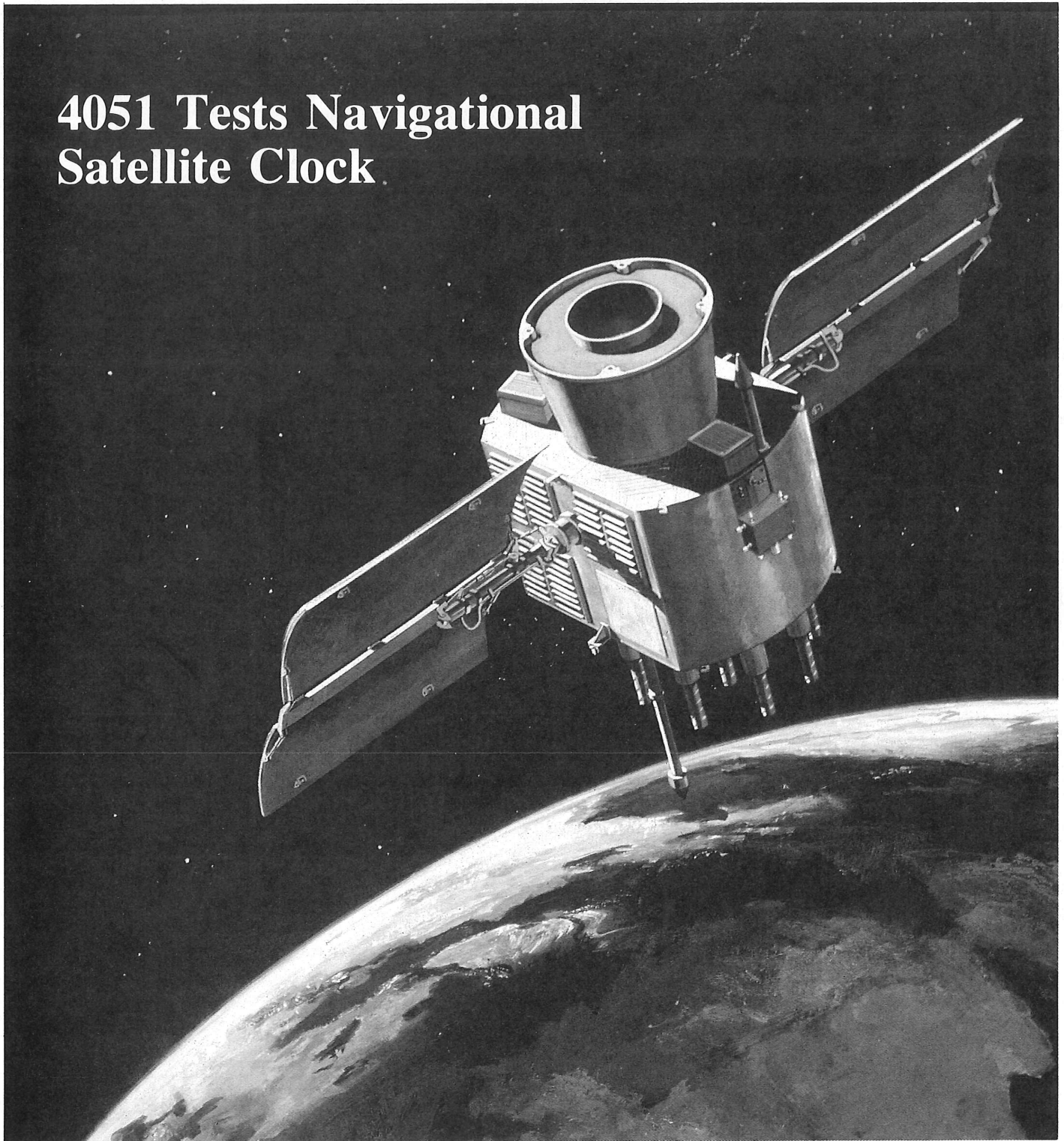

Tekniques

In This Issue

| | |
|--|----|
| 4051 Tests Navigational Satellite Clock | 2 |
| Plot 50 Picture Composition Combines with 4054 to Create Easy-to-Use Design Tool | 8 |
| Department of Commerce Streamlines Graphics and Typesetting through a 4051 | 12 |
| Input/Output | 16 |
| Tektronix Expands Its Family of Graphic Copy Devices | 17 |
| Editor's Note | 20 |
| Programming Tips | 21 |
| BASIC Bits | 26 |
| New Abstracts | 27 |
| Peripheral Maintenance is Important Too | 28 |
| Library Addresses | 31 |

TEKniques, the 4050 Series Applications Library Newsletter, is published by the Information Display Division of Tektronix, Inc., Group 451, P.O. Box 500, Beaverton, Oregon 97077. It is distributed to TEKTRONIX 4050 Series users and members of the 4050 Series Applications Library.

| | |
|--------------------|-----------------|
| Publishing Manager | Ben Buisman |
| Managing Editor | Patricia Kelley |
| Editor | Terence Davis |
| Technical Editor | Dan Taylor |
| Graphic Design | John Ellis |
| Circulation | Rory Gugliotta |

Copyright © 1981, Tektronix, Inc.
All rights reserved.

To submit articles to TEKniques or for information on reprinting articles, write to the above address. Changes of address should be sent to the 4050 Series Library serving your area (see Library addresses).

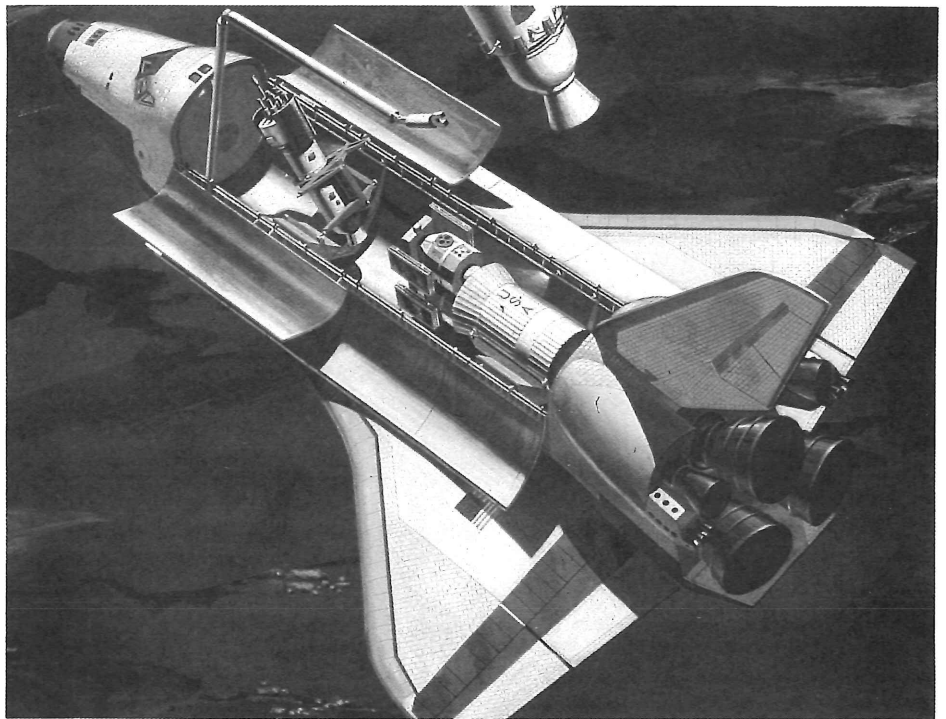

Future plans call for launching the NAVSTAR-GPS satellites, with propulsion stages attached, from the space shuttles. Two GPS satellites are being launched in this artist's concept.

4051 Tests Navigational Satellite Clock

by Terry Davis
TEKniques Staff

The NAVSTAR Global Positioning System (GPS) is the culmination of modern technological challenge: a passive system to provide precise navigation capabilities. Once effected, the system will provide worldwide users with instantaneous three-dimensional pinpoint navigation. It will be available, when complete, to users ranging from commercial, private, and military aircraft, to ships, to individuals backpacking in the mountains.

Consider the complexity of the challenge. The Global Positioning System will consist of 24 satellites, each containing 33,000 parts. Some of these parts are themselves pushing at the state of their art, while the sheer number of parts that must continually function adds a new dimension to the reliability problem.

At Rockwell International in Anaheim, California, 4051-based test stations measure the performance of the system's atomic clock heart, in tests that must run

uninterrupted for many days. To make certain that the satellites will operate reliably, state-of-the-art testing and measurement techniques have been developed by a group of dedicated engineers at Rockwell's Metrology Lab in Anaheim, headed by Frank Koide, Sr. Project Engineer.

Although there are complex problems to be solved, the idea behind the GPS concept is relatively simple: When a system user wishes to establish position, a receiver picks up signals from three (or more) satellites. If the user's clock is synchronized with the satellite clocks, the difference in time between transmission by the satellite and reception by the user can be easily found. Position is then determined from calculations of the intersections of three spheres centered on each of the satellites.

The system also accommodates users without synchronized clocks, as long as

they have simultaneous line-of-sight communications with four satellites. Synchronized time isn't required with four satellites because the simultaneous reception of four signals produces three independent range differences. From these, the intersections of three hyperboloids of revolution may be determined, which leads to dynamic calculations of user position and velocity.

When operated, the user's receiver will automatically select the four most favorably located satellites, lock onto their navigation signals, and compute the range to each (Fig. 1). It will then generate four simultaneous equations with four unknowns: three coordinates of the user's position (U_x , U_y , and U_z), and the clock bias factor. A microprocessor in the set will solve the equations for the time and the user's position and velocity.

In operation, each satellite of the constellation will transmit two L-band¹ radio signals. The transmitted data from each satellite will include a Pseudo Random Noise (PRN) signal. The message is transmitted on a 50 bit-per-second data stream that provides the user with the satellite position (ephemeris), and information about the on-board frequency standard (clock) from which the PRN code is derived. The PRN code is modulated on the two L-band carrier signals so that the user may correct for signal delay through the ionosphere. The dual frequency transmission lets the microprocessor in the users set extract any unmodulation variations in the signal.

Of course, the sophistication of the user's unit will be dictated by particular navigational needs. A typical user set will include a radio receiver with an omnidirectional antenna, a signal processor, and a microprocessor-controlled readout. Since the sets operate passively, an unlimited number of users could engage the system without saturating it, or revealing their position.

NAVSTAR System Complexity

To make the system easy for the user, the system must do a lot of the work, transparently, constantly, and reliably. There are three major subsystems in the space vehicle that generate and radiate the L-band navigational signals. The source of the navigational signal is the rubidium frequency standard, which gen-

¹ L-band is that part of the radio spectrum from 390-1550 MHz.

A Look at Navigational Satellites

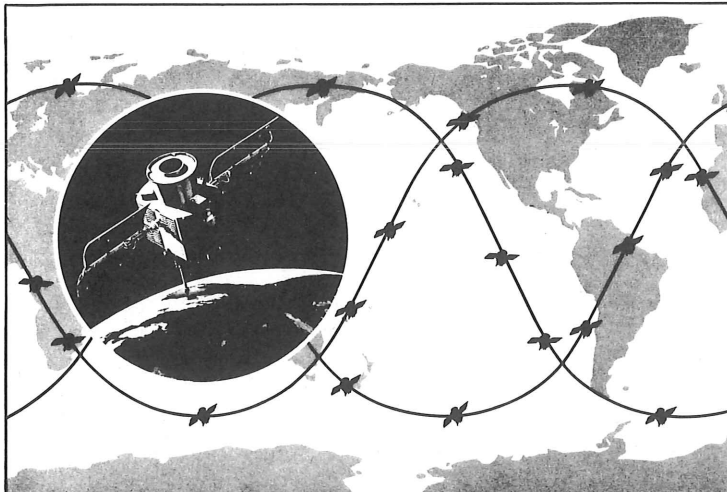

There will eventually be 24 NAVSTAR-GPS satellites in orbit approximately 11,000 miles above the earth's surface.

The use of satellites for determining earth positions was begun in 1964, when the U.S. Navy began using the Transit System. Transit calculates position using the varying doppler shift² of a radio signal transmitted by a passing satellite. This system still enables submarines to determine their positions with an accuracy of one-tenth of a nautical mile.

Also in 1964, the Air Force began investigating satellites as navigational aids for aircraft and spacecraft. The system, designated 621B, measured positions with accuracies on the order of tens of feet and velocity to a fraction of a foot per second.

In May 1967, the Navy developed a new navigational satellite system called Timation. Designed to provide worldwide continuous three-dimensional position and velocity navigational data, its accuracies were comparable with those of the 621B system. Timation demonstrated the capability of instantly determining the distance between the satellite and the ground. If a pulse, triggered by a very accurate clock in the satellite, were received by a ground station that also contained an accurate clock, the transit time from the satellite to the ground station could be measured and the distance computer.

Timation II was launched in September 1969, and Timation III — redesignated

²Doppler shift calculations utilize the doppler effect to calculate velocity and position. The doppler effect is the observed change of frequency of a signal, as distance to the source increases or decreases. Traffic radar is a common example.

Navigation Technology Satellite I (NTS I) — was launched in July 1974. NTS II was launched in June 1977. In 1970, the 621B System was renamed Defense Navigational Satellite System (DNSS) and, in October 1973, that name was changed to Global Positioning System (GPS). The GPS program includes features from both the DNSS and Timation systems. These multiservice interests are now all joined in a combined program called NAVSTAR — GPS.

NAVSTAR — GPS will be developed over the next several years in a three-phase evolutionary program. The end result will be a global operating system of 24 satellites orbiting the earth at an 11,000 mile altitude: each plane will consist of eight satellites. Fig. 1 illustrates the satellite constellation.

The first phase of the program will be the validation phase. This phase calls for five Rockwell NAVSTAR satellites to join the NTS II satellite in two planar orbital constellations. The second phase, in the early 1980's, calls for five new satellites, bringing the total to 11 in three orbital planes. The third and last phase, to be completed in the mid-1980's, will make the system completely operational.

The first series of six satellites are in orbit and have been declared operational, with each satellite carrying three redundant rubidium clocks. Intermediate test results have demonstrated navigational accuracies of a few meters in all directions. Rockwell is currently developing rubidium clocks for the phase 2/3 program, for GPS satellites 9-12.

erates the stable 10.23 MHz reference (atomic clock); it's the source for all other signals as well. The clock information is processed through the carrier for navigation data transmission. The third major system is the antenna assembly. The antenna assembly has the special problem of providing uniform signal intensity in the particular satellite's designated ground space. The system parts are illustrated in Fig. 2.

Picture the complexity of the overall navigational system. For an operation system, 24 satellites must remain in orbit and operational. With over 33,000 parts in a satellite, the complete system will have over 792,000 parts. Reliability is a must, and calls for thorough testing and evaluation. But since the atomic clock is the heart of the system, and since that's where the 4051 systems play a major role, the remainder of this article will focus on the clock system and it's testing.

The Atomic Clock

For its atomic clock, the GPS uses a commercial rubidium frequency standard. It's repackaged for this application, with extensive modifications to meet the environmental and reliability needs of space. Spacecraft system interface requirements are added as well. These clock systems must be tested to assure that design goals are met; five years of continuous satellite operation is just one of these goals.

Automated testing of the clock system is a must for several reasons. There are large batches of data to be collected, for instance, over long time periods. And this data must be extensively processed after collection. To meet these needs, Frank Koide and other Rockwell engineers developed 4051-based test system stations. The systems control the atomic clock mounting plate temperature, supply voltage, mode, and digital tuning, while collecting, processing and/or transmitting test data.

There are four test stations, each controlling simulated space pressure (vacuum) and temperature, and providing the necessary stimulus to the atomic clock (Fig. 3). The test stations collect data and feed it to a PDP-11 minicomputer for extensive processing. In case of a mini-computer failure or interface failure, the 4051 can collect and store the data locally, on tape, to prevent any data loss. This is especially important in long-term tests, such as the nine-day reliability tests, where uninterrupted data collec-

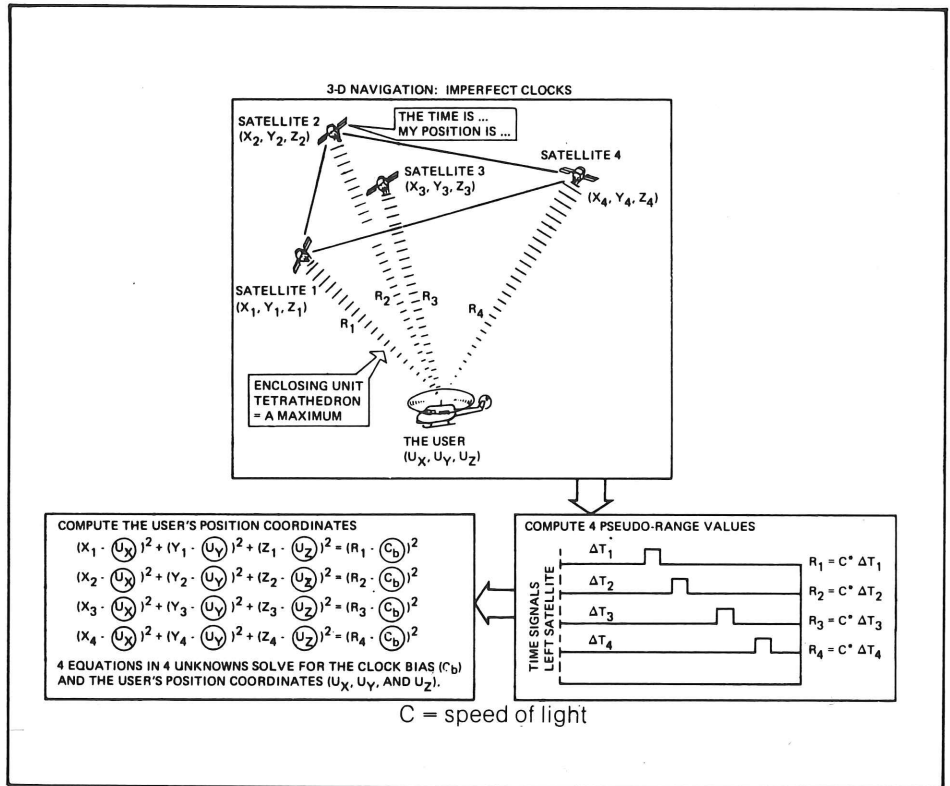

Fig. 1. Three-dimensional navigation is also possible with imperfect user clocks, by locating four satellites and computing the range to each.

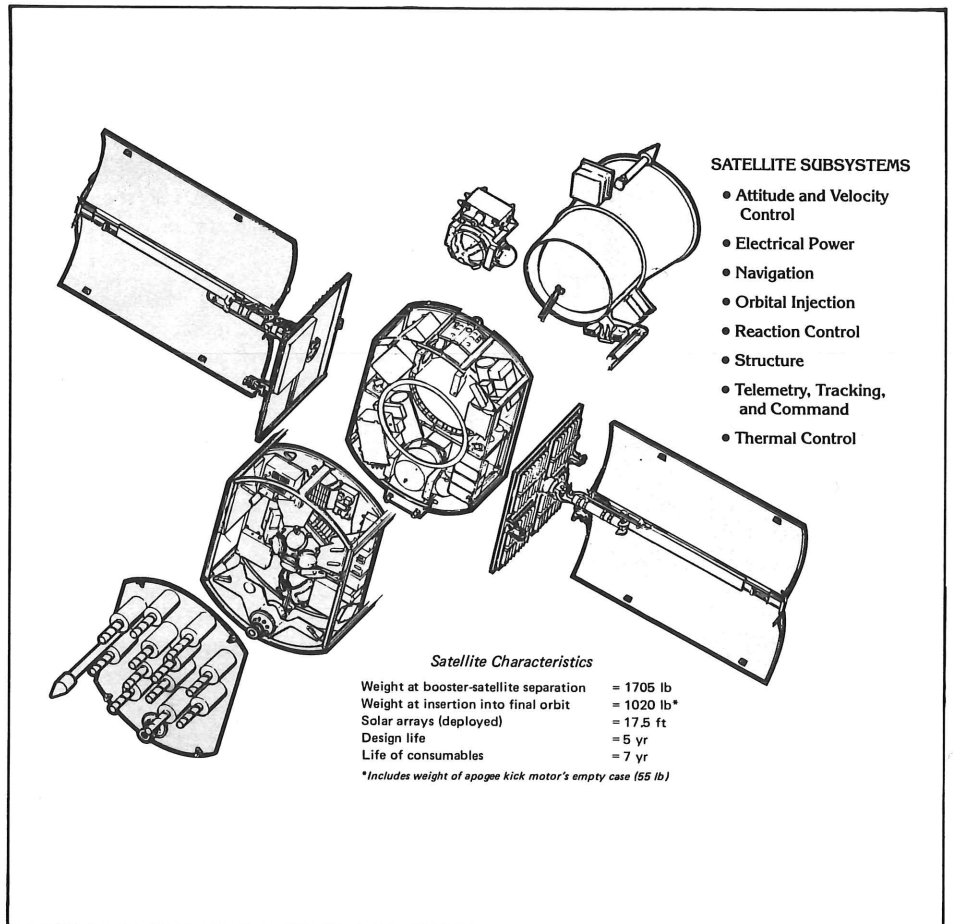

Fig. 2. There are over 33,000 parts in each satellite. Three redundant clocks provide sufficient backup to cover system failures.

tion must occur for 800,000 seconds in order to achieve the desired confidence level for current testing. This test may extend to 90 days of continuous testing for the full-scale production phase.

The 4051-based test stations must perform a number of tests and condition simulations during the development cycle, to continue on to the phase two effort. The basic concept of the tests is shown in Fig. 4, while Fig. 5 shows a block diagram of a production test station.

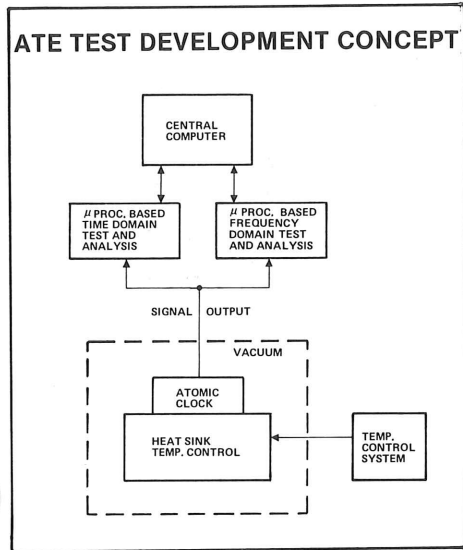

Fig. 4. The automated testing concept.

Figure 6 shows a test station, with Frank Koide and his associates. Frank's group implements the test concept through programs that run on the 4051-based stations. There are 11 programs currently in use in the test stations, each providing another piece to the reliability puzzle. The Long-Term Frequency Stability Test checks the clock frequency stability over time. The frequency is specified as the Allan Variance for sample times from 1 to 10^5 seconds (Fig. 7). The output from this test is a table, but the data is later analyzed and plotted using the group's program Graphical Plot.

Frequency vs Power Supply is another system test that provides tabular output. In this test, the clock power supply frequency is checked and recorded, first with the power supply set to high limits, then set to low limits. The difference between the frequencies of the two tests is measured variation as a result of power supply variation.

Further test data is gathered in the Frequency vs Varying Temperature Test. This is important since a satellite, orbit-

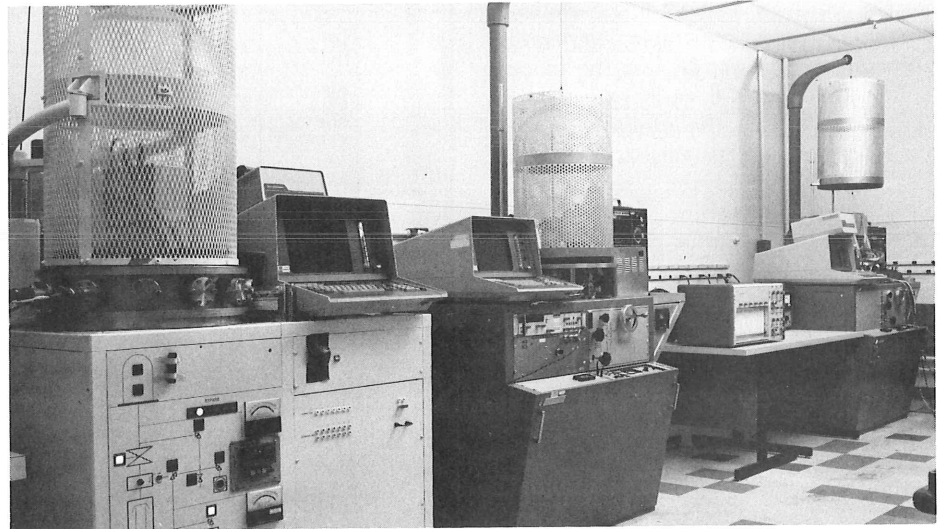

Fig. 3. Three of the four automated test stations. In the two stations on the left, clock assemblies are being tested under the bell jar in a simulated space atmosphere. The right station bell jar is about to be lowered to the base plate on the vacuum stand.

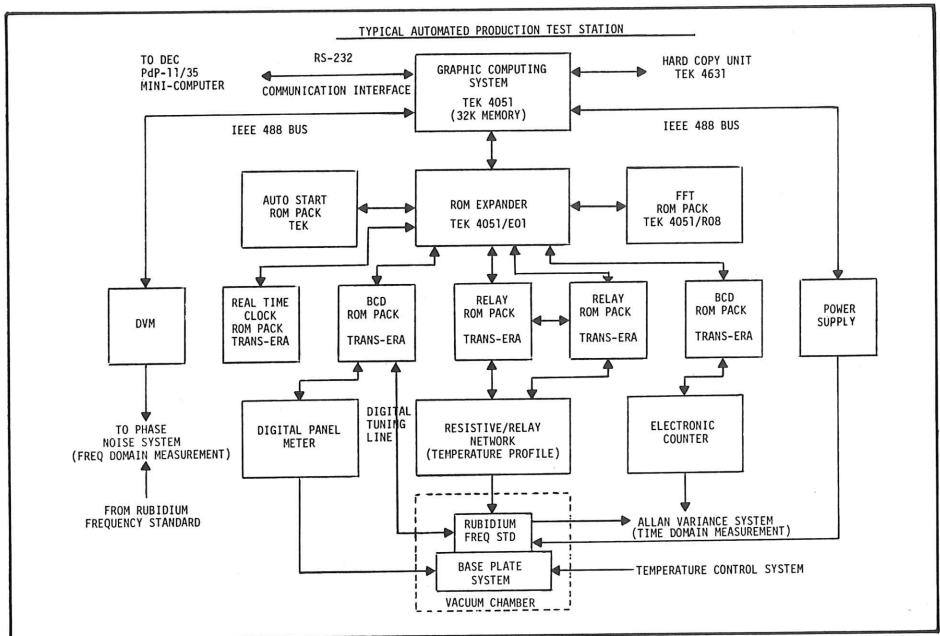

Fig. 5. A typical automated test station is illustrated in this block diagram.

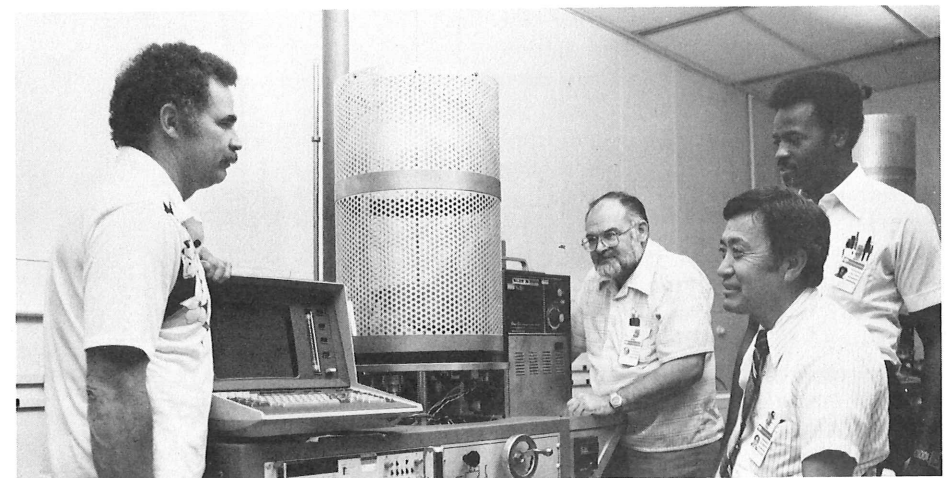

Fig. 6. Frank Koide, Senior Project Engineer, is seated in front of one of the automated test stations. Standing, from left to right, are Ken Martin, Laurie Baker, and Collin Sanders, Jr., who have all played key roles in developing the system.

ing the earth at 12-hour intervals, will encounter some predictable temperature excursions (Fig. 8). To test the clock's ability to function accurately with temperature change, the clock mounting plate temperature is varied. The clock frequency is heterodyned with the primary atomic clock reference frequency; accumulated time error is calculated from the resultant beat periods. Fig. 9 graphs the clock mounting plate temperature and the resultant beat period data.

In case of clock frequency drift in satellite orbit, the clock can be digitally tuned from the ground, in steps of four parts in 10^2 . In addition to this primary reset method, the clock assembly also features a Voltage Controlled Crystal Oscillator (VCXO), normally phase-locked to the atomic clock. This oscillator is also capable of operating independently as a clock, in backup mode. These functions are also tested and evaluated by the test stations, using BASIC programs written by the test group.

The above test programs deal primarily with data gathering at the test station, and the reduction of that data. Further data evaluation use the engineering data analysis programs. The Graphic Plot program accepts data from the Power Spectral Density Test and the Long-Term Frequency Stability Test (LTST), and graphs the output of the tests. In addition, this Graphical Plot and LTST allow the engineers to access data on the host computer, during production testing, without test interruption. Data for the Power Spectral Density Tests can also be plotted as Allen Variance Plots and Linear Plots.

Results and Directions

The NAVSTAR System automated testing began with one 4051-based station; there are now four stations as they move into the phase two stage. The results are pleasing. Says Koide, "Use of automation has been a key factor in the success of the test program to date. With the accelerated production schedules and heavy demand on test stations, it is highly unlikely that the present state of development could have been achieved without these automated tests. The automated test stations have essentially provided unattended operation 24 hours a day, thus reducing costs and increasing productivity."

The combination of graphics and local processing power provides the test ver-

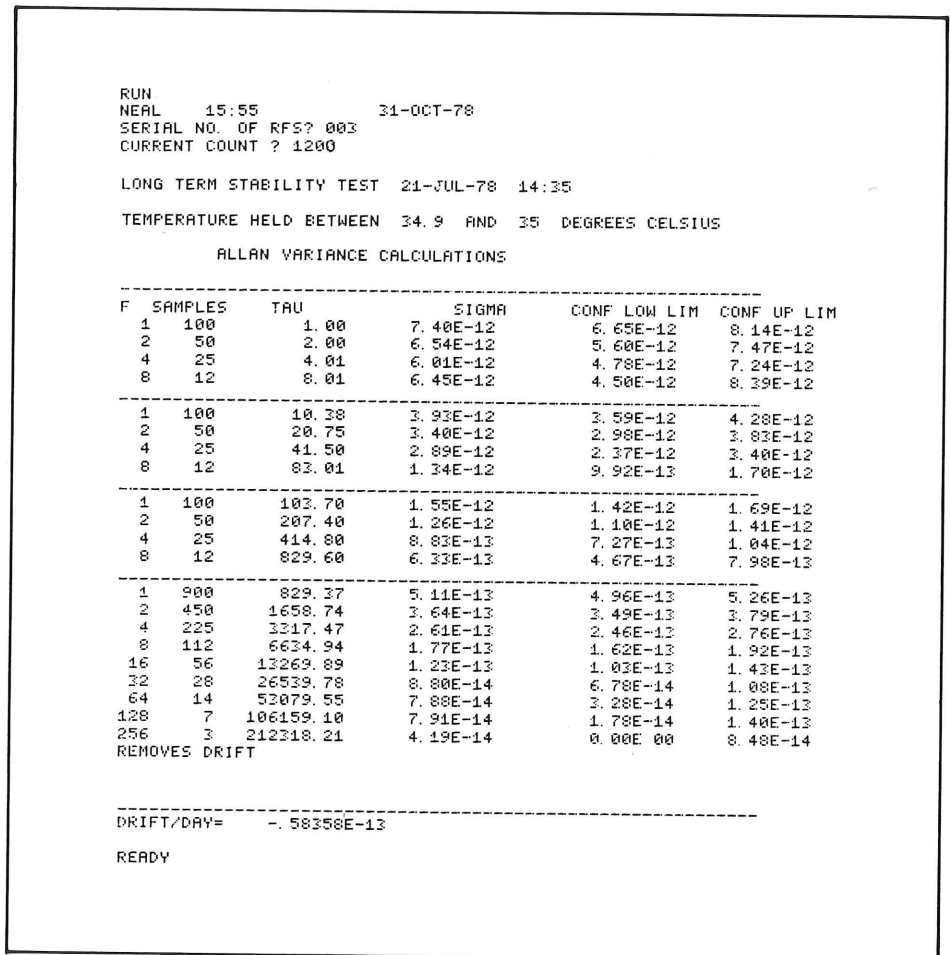

Fig. 7. The Long-Term Frequency Stability test checks the clock frequency stability over time.

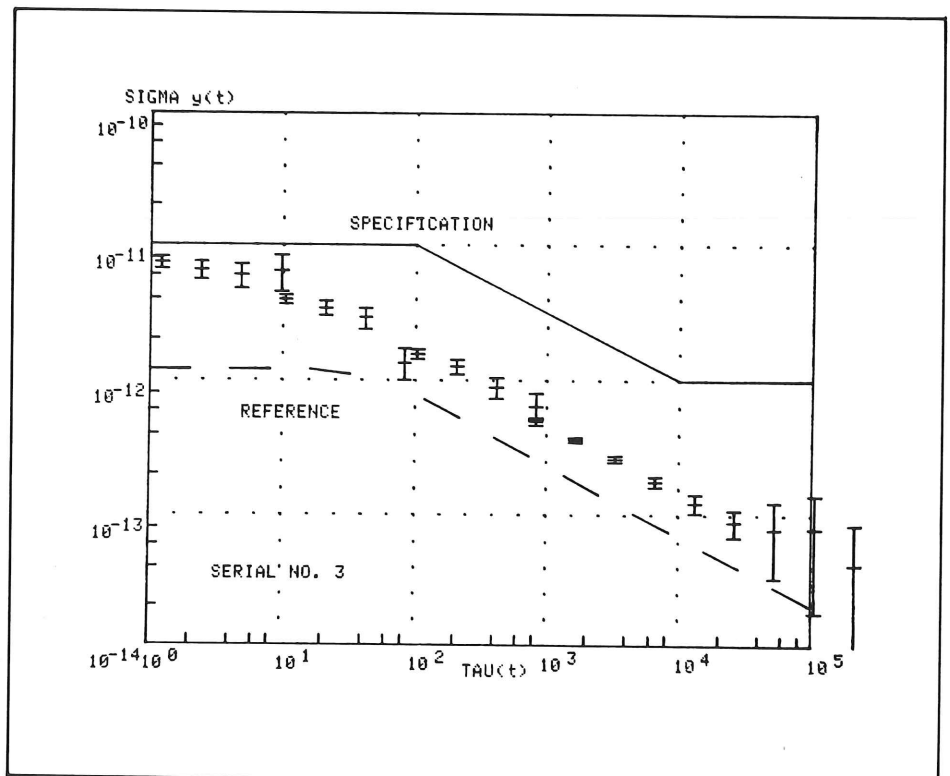

Fig. 8. Frequency vs Varying Temperature is an important test, since the satellite will encounter some predictable temperature excursions.

satellite necessary to test and evaluate a complete system. In long-term tests, the 4051 can act as a back-up to prevent loss of test data due to interface or computer failure. (The nature of the tests would require a restart from the beginning if any loss occurs.) The availability of local processing, such as the FFT transforms, is a great time saver in the test cycle. Fig. 10 is a comparison of running such transforms on the 4051 and the IBM mainframe. Note that, although the large computer can process the operation faster, the overall turn-around time is much shorter using the stand-alone desktop computer.

The 4051-based test stations allow timely completion of tests and have allowed increased confidence in the designs. The tests enable design perfection in areas where tests found problems. And the clocks will continue to be tested in this manner, to provide production parts for the complete satellite system. The end result of the tests is keeping the NAVSTAR-GPS system on schedule. In so doing, an idea of a few years ago will be translated into a complex, precise reality.

TEKniques would like to thank Brent Rigby, Tektronix Sales Engineer in Irvine, CA., for bringing this application to our attention. And, of course, many thanks to Frank Koide at Rockwell International for his invaluable assistance in preparing this article.

FREQUENCY VS TEMPERATURE TEST PROFILE (SN 025)

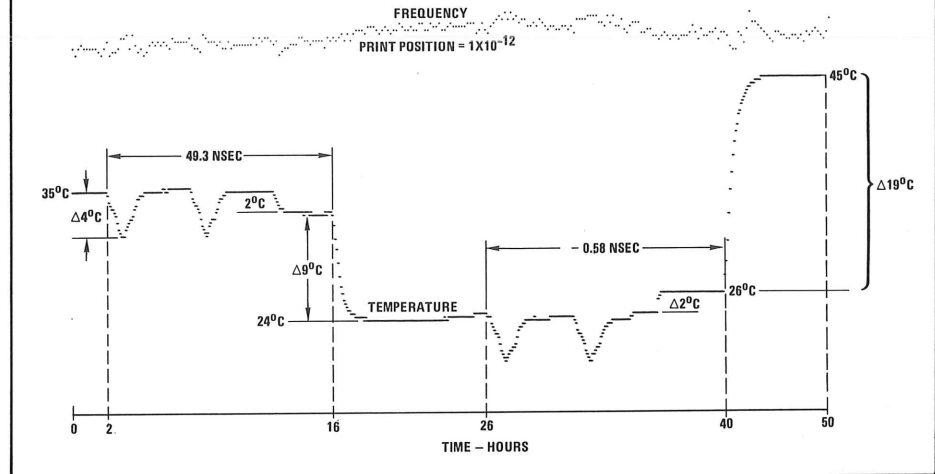

Fig. 9. Clock mounting plate temperature is graphed against the beat periods from the test.

LARGE SCALE COMPUTER — FREQUENCY DOMAIN DATA ANALYSIS

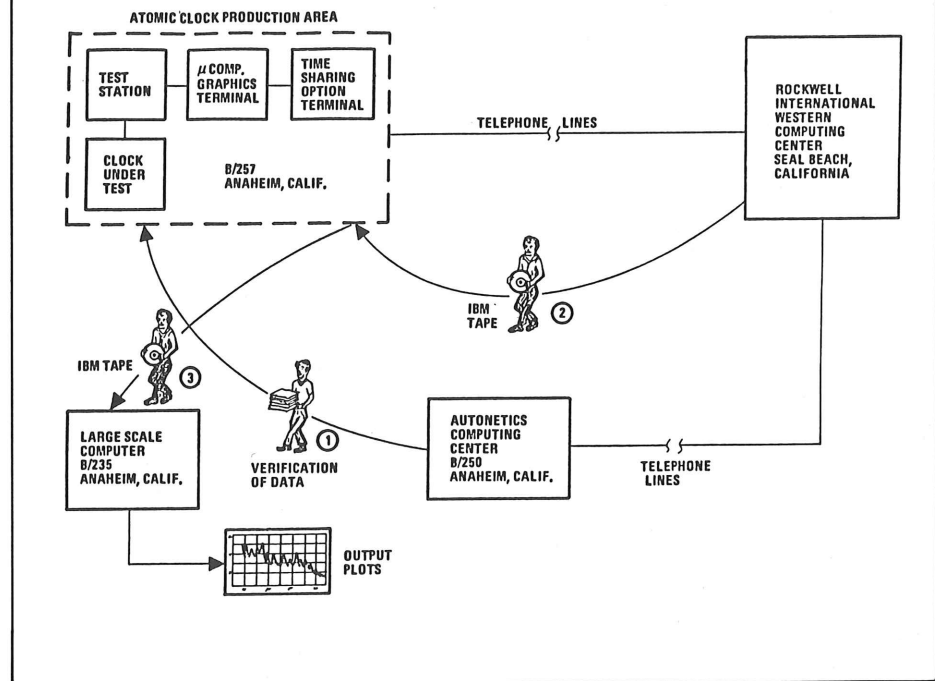
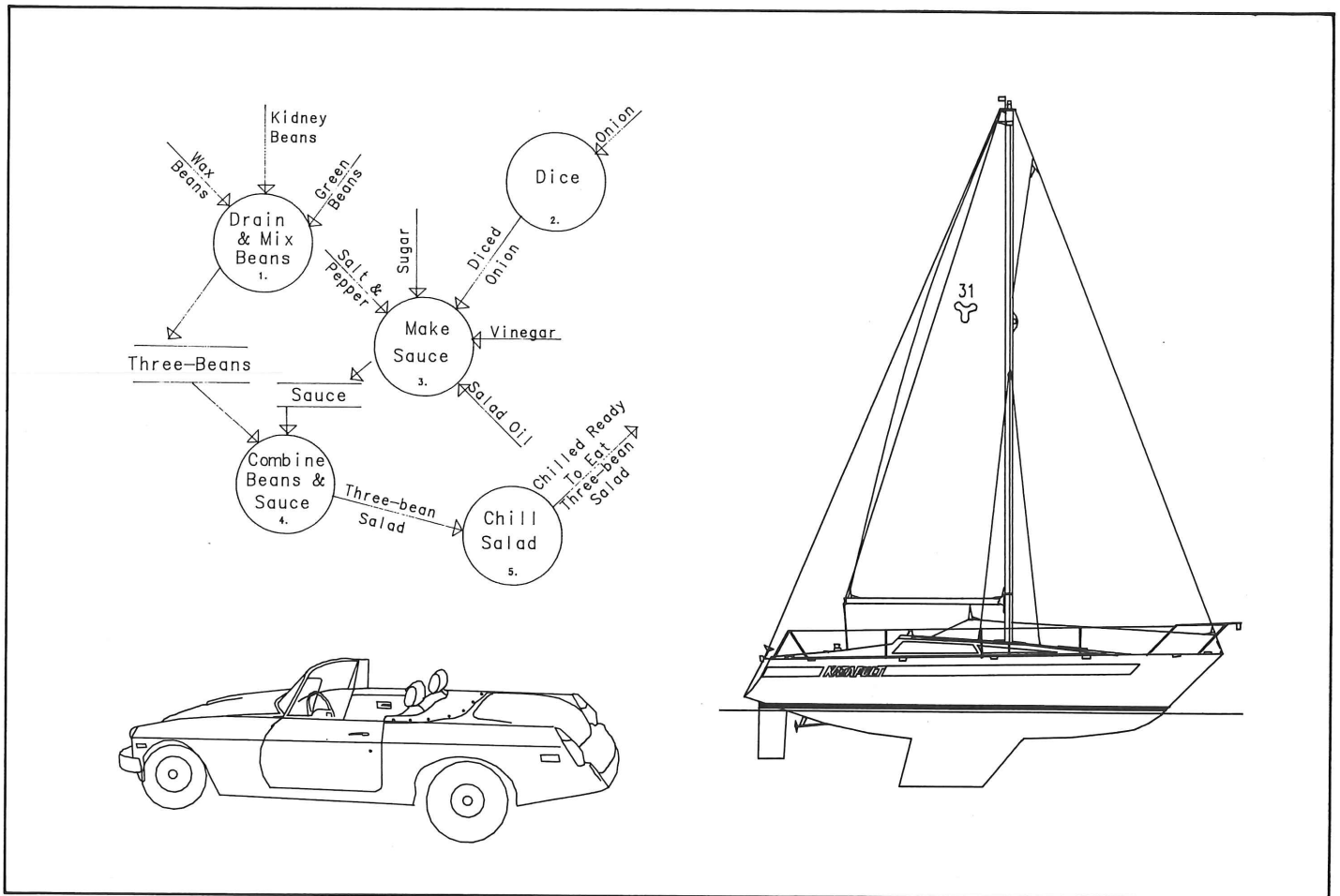

Fig. 10. A comparison of computing and plotting FFT transforms on the 4051 and on the IBM mainframe. In the test stations, the FFT ROM Pack is located within the block in the upper left.

PLOT 50 Picture Composition Combines with 4054 to Create Easy-to-Use Design Tool



by Jane Massey
Tektronix, Inc.
Wilsonville, OR

Your 4054 Desktop Computer becomes an interactive electronic sketch pad when you use the newest PLOT 50 software: Picture Composition. It puts at your disposal all graphic primitives (arcs, lines, circles, boxes), software-generated characters in multiple character fonts, and various dash patterns from which to create a picture. Through extensive use of the dynamic graphics of the 4054, Picture Composition simplifies and enhances the creation and editing processes.

Because Picture Composition is menu driven and employs two operating modes

(elementary or full), it is easy to learn, yet powerful. You sketch an existing picture or create a new one by simply entering the graphics using the thumbwheels or the 4952 Joystick, or by using the 4956 Graphics Tablet. Once you've defined your picture, it may be saved and incorporated within other pictures, i.e., as a symbol or subpicture.

A tutorial quickly introduces you to Picture Composition. And HELP routines aid you throughout the design process.

Using Picture Composition you can quickly and easily:

- Design facilities or schematic layouts
- Draw organizational charts
- Design flow charts and flow diagrams
- Document illustrations
- Trace outlines from photographs or other illustrations
- Compose overhead slides

How It Works

When you autoloading tape, a master menu provides the entry into the program. Fig-

ure 1 illustrates the flow of program operation depending on the menu item chosen. And choosing a menu item is easy: you simply pick it using the thumbwheels or joystick to move the refreshed symbol to the desired menu item; or pick it from the tablet menu using the writing pen or button cursor. No commands need be typed in. If other input is required, Picture Composition will

prompt you for it. Let's take these sub-menus one at a time, in the order a new user might.

The Tutorial

Picture Composition provides a Tutorial as a primer in using the package. The Tutorial's four-phase structure is aimed at varying levels of users and may be entered at any of the phases.

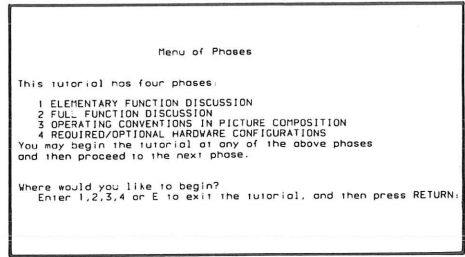

Phase 1 describes the elementary mode of operation. When you're familiar with Phase 1, you could choose Phase 2 for an explanation of the full mode of operation.

Phase 3 discusses the operating conventions used in Picture Composition. And Phase 4 details the hardware configurations which Picture Composition supports.

HELP

A look at Figures 1, 2 and 3 shows that HELP is available in any of the Picture Composition operations. When you select HELP, a brief summary of each menu item within that operation will be displayed on the screen. For example, HELP chosen when you're in Menu Operations (menu 3 in Figure 1) would provide a message on each of the items contained on that submenu, such as Plot Menu or Create Menu:

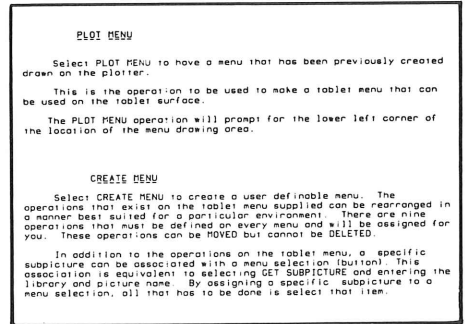
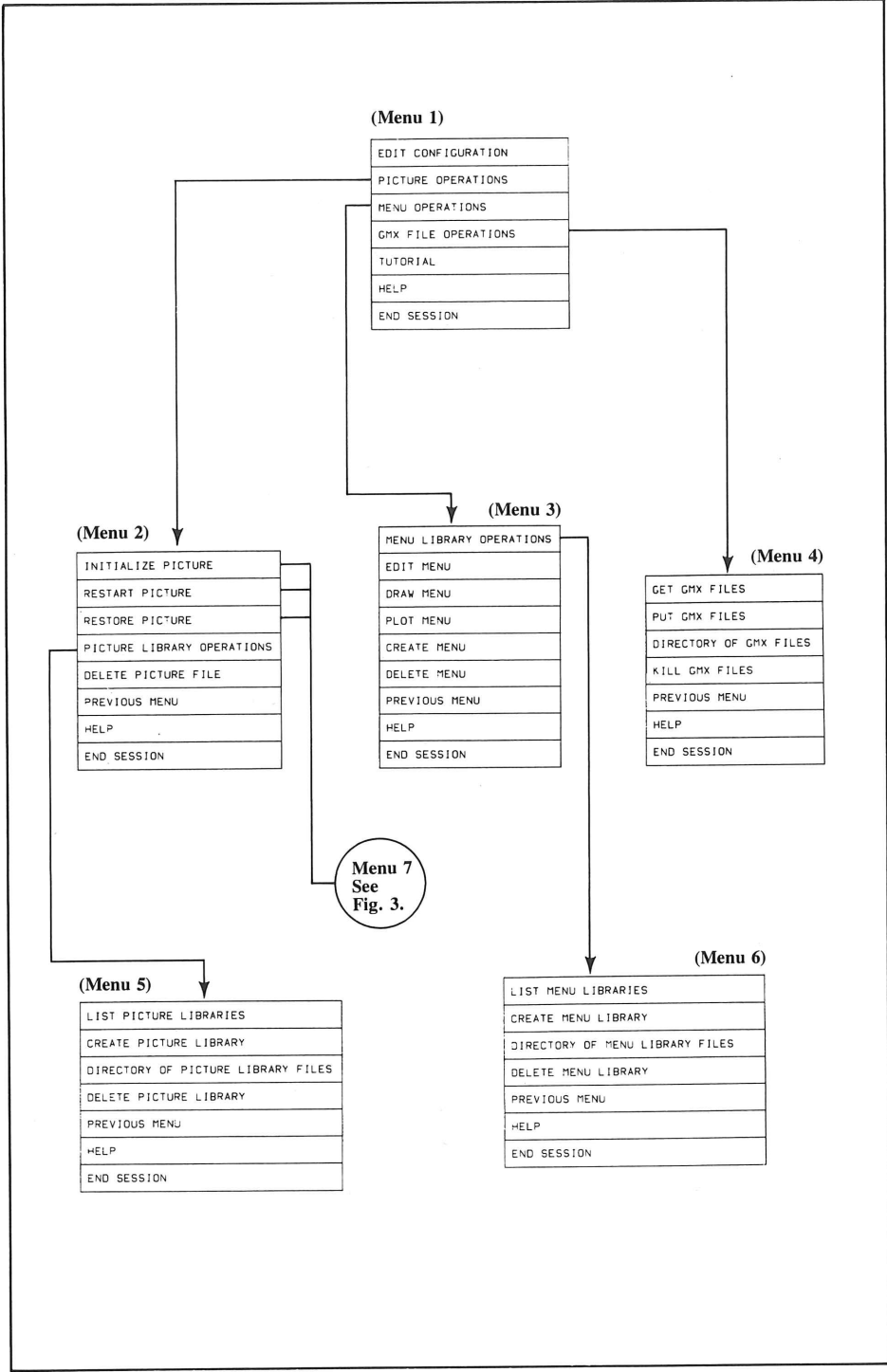

HELP when you're using the menu to compose your picture (Figure 2 or 3) would provide information on each picture composition component, such as Circle:

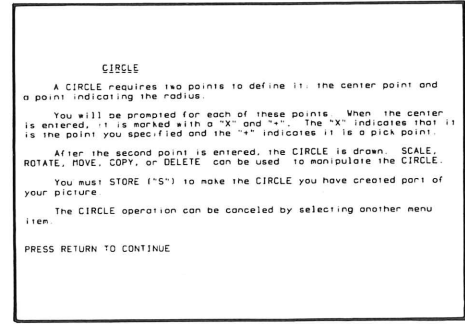

Fig. 1. Picture Composition is menu driven. For example, if from the main menu (Menu 1 above), you picked Menu Operations, the program would present you with Menu 3. Once you chose your operation from this menu, you'd be prompted for the required input.

Picture Operations

Once you've viewed the tutorial and learned how to get help when it's needed, you might try your hand at composing a picture. It's here that the two operating modes facilitate composition and learning, while providing refinements. The elementary mode contains all of the basic graphic primitives without confusing a new user with unfamiliar options. The elementary mode menu is shown in Figure 2. For a good many of your sketches, you may find the elementary mode sufficient.

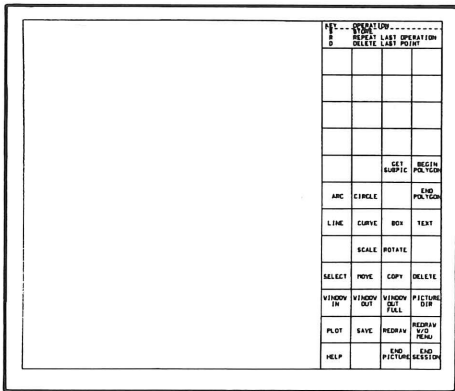

Fig. 2. All the basic graphic primitives are available in Picture Composition's elementary mode of operation.

However, the full mode allows you to incorporate refinements into your design; note the added options in the full menu in Figure 3. (Only slight differences exist between the tablet menu and the 4054 screen menu.)

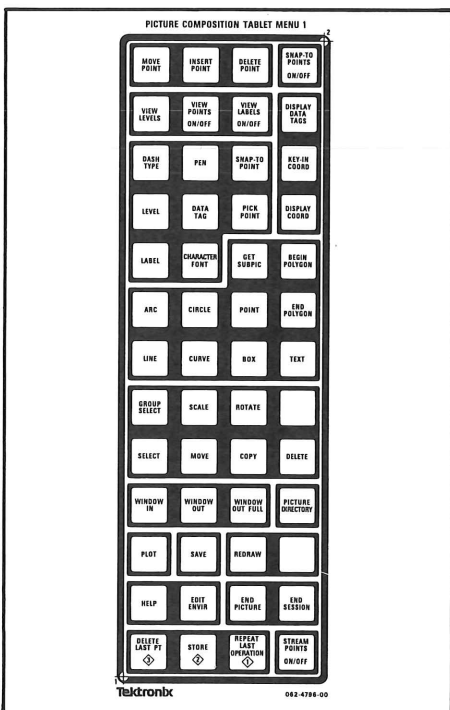

Fig. 3. The full mode of operation incorporates options for refining your drawing.

Let's take a quick look at composing a picture in the elementary mode. Using the graphic primitives — arcs, circles, polygons, and so forth, you create your picture. Notice that any of these primitives including text, or any of the completed objects, may be rotated, moved, scaled or deleted. The object will appear in refresh with the completion of each transfer motion. Picture Composition keeps you informed of where you are. Once you've created your object, it may be "copied" to another location — no need to repeat your design efforts.

The complete picture may be saved. A picture may be recalled to be used within another picture. Thus, you can build a library of symbols designed for your specific applications. And any completed object or picture may be recalled and edited.

In the full mode of operation, you can select from four fonts for text. You can window in and out (zoom) on areas of your picture. In full mode you may also assign open numbers and dash types to objects. Parts of objects may be edited in full mode. Reference and snap-to grids are available to aid in object placement.

Picture Library Operations

Picture Composition enables you to manage the drawings (pictures) on the data disk. Pictures relating to one specific subject can be stored under one library name for ease in retrieval. Picture Library Operations helps you do this simply and easily.

You may also get a list of the libraries and pictures stored on the data disk. Picture may be deleted when no longer needed.

Menu Operations

Picture Composition lets you create (design) your own menu. Figure 4 is a sample of a menu created and plotted using Picture Composition.

GMX File Operations

TEKniques Vol. 4 No. 1 described the PLOT 50 Standard Data Files. These files provide a means to allow different data analysis programs access to the same data. Now Picture Composition introduces the new PLOT 50 standard transfer format for graphic data, known as GMX. Utility programs in Picture Composition generate and retrieve GMX files.

The GMX files will allow different graphic applications a means to access the same data base. So 4050 users may use the GMX files for their own applications, their structure will be detailed in the March issue of TEKniques.

Picture Composition and Document Preparation

Another new PLOT 50 software package can be used with Picture Composition for preparation of reports, articles, papers or other illustrated documents. PLOT 50 Document Preparation can be used for text manipulation while Picture

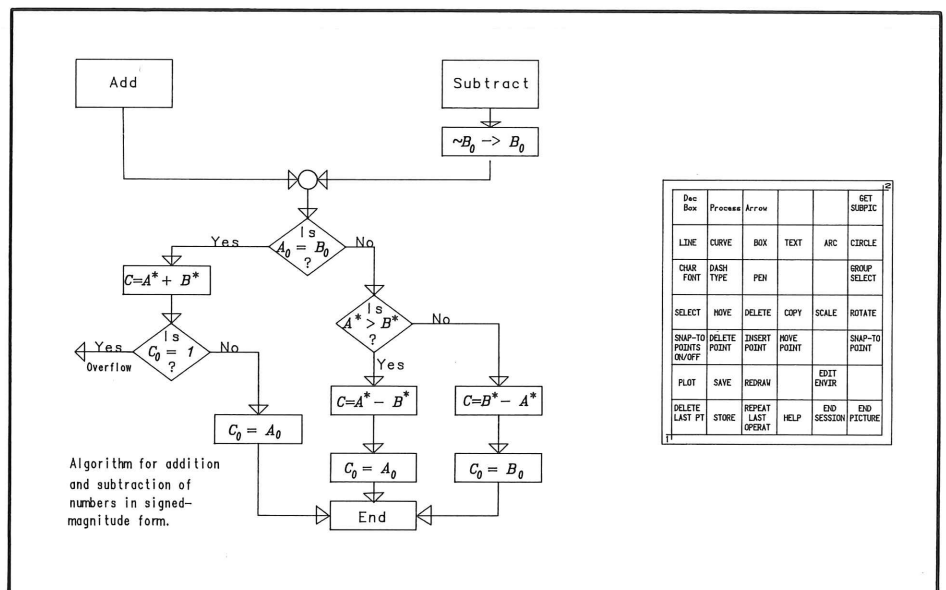

| | | | | |
|-----------------------|--------------|--------------------|------------|---------------|
| Doc Box | Process | Arrow | | GET SUBPIC |
| LINE | CURVE | BOX | TEXT | ARC |
| CHAR FONT | DASH TYPE | PEN | | GROUP SELECT |
| SELECT | MOVE | DELETE | COPY | SCALE |
| SNAP-TO POINTS ON/OFF | DELETE POINT | INSERT POINT | MOVE POINT | SNAP-TO POINT |
| PLOT | SAVE | REDRAW | | EDIT DIVIS |
| DELETE LAST PT | STORE | REPEAT LAST OPERAT | HELP | END SESSION |
| | | | | END PICTURE |

Fig. 4. Picture Composition allows you to create menus for specific purposes. The one above is used to design flowcharts such as the one illustrated.

Composition facilitates the illustration task. More on PLOT 50 Documentation Preparation will be forthcoming in a later issue of TEKniques.

A Powerful Graphic Aid

Picture Composition's intensive interactive nature coupled with ease of use give any user a powerful sketching tool without intensive training. In fact, the first time user could easily produce a design and walk off with it after an hour of orientation.

Picture Composition guides you from beginning to end whether you are sketching using the 4054 thumbwheels/joystick, or the 4956 Tablet. This article has briefly described some of the many features:

- Tutorial
- HELP
- Menu Driven — no commands to learn

- Picture Operations
 - Create Pictures
 - graphic primitives
 - multiple character fonts
 - various dash patterns
 - software-generated characters
 - Save, Recall and Edit Pictures
- Picture Library Operations — Subpictures
- GMX (graphic data transfer) format fully supported
- Use with Document Preparation to prepare fully illustrated documentation

When you start using Picture Composition, you'll realize its versatility and discover many more features.

Equipment

A 4054 with 64K of memory and dynamic graphics (Option 30), and a 4907

File Manager with dual disk units (Option 30) are the minimum configuration for Picture Composition. However, the package will support a 4907 File Manager with Option 31 (three disk units).

Graphic input may be entered through the thumbwheels which are an integral part of the 4054. Optionally, a 4952 Joystick or 4956 Tablet may be used.

Output may be displayed on the 4054 screen, or sent to a 4662 or 4663 Digital Plotter. And, of course, the 4631 Hard Copy unit may always be used.

More Information

Ask your local Tektronix Sales Engineer to demonstrate Picture composition (4054D06), or Document Preparation Get a hands-on experience. 

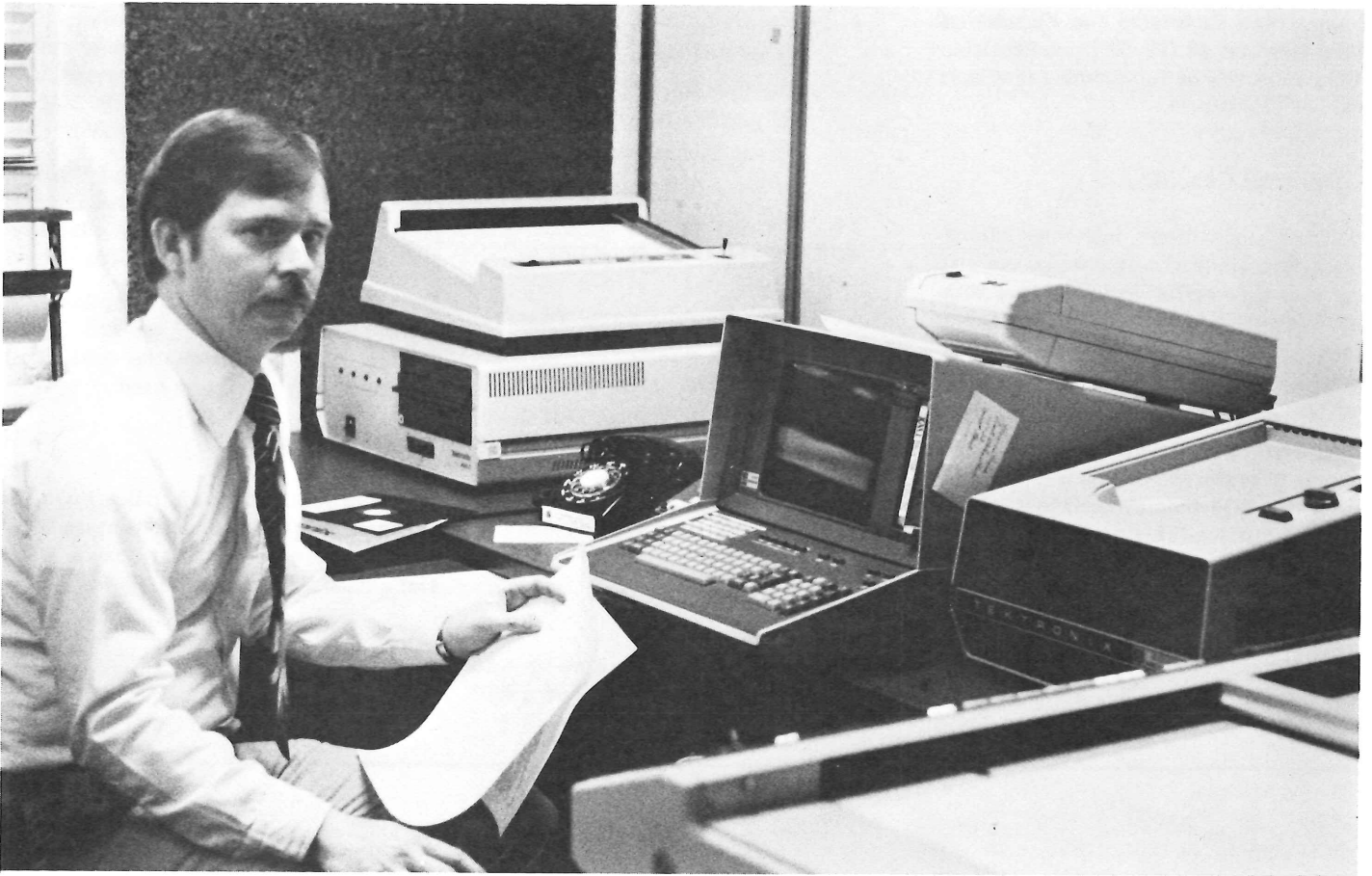

At the Office of Publications within the Department of Commerce, Bob Wildman demonstrates how they have streamlined their typesetting operations.

Department of Commerce Streamlines Graphics and Typesetting through a 4051

by Patricia Kelley
TEKniques Staff

At the U.S. Department of Commerce in Washington, D.C., Bob Wildman and Tom Beacom are staying on top of things in the Design & Graphics Division of the Office of Publications with some innovative methods. Like Mallory Green and John Piper's group at HUD,¹ they are a service agency. In fact, 14 different DOC bureaus including four of the largest, the International Trade Administration (ITA), the Census Bureau, National Oceanic & Atmospheric Administration (NOAA) and the Maritime Administration — plus the President's Council of Economic Advisers (CEA) — depend on the Office of Publications for their graphic work.

¹See TEKniques Vol. 4 No. 8; "Fast Do It Yourself Graphics at HUD."

The Division's Art Production Branch produces camera-ready mechanicals for printing, and creates charts and graphs from rough drafts or specifications sent to them by the various bureaus. The camera-ready copy is returned to the bureaus for incorporation directly into their reports and publications. Among the charts produced are those recording America's Gross National Product and Balance of Payments.

The staff is small, 25 in Design & Graphics, of which only 8 are in the Art Production area; but their workload is tremendous — over 3,100 requests during FY/1980. They bill in the neighborhood of \$1 million annually. And as might be expected, their work can be extremely detailed; one chart, depicting interest

rates, in the Economic Report of the President to Congress, had 2,559 plot points on it!

To overcome such enormous odds, Division management decided to automate, choosing a 4051 with Option 1 Data Communications Interface and a 4663 Plotter to get the job done. A contract programmer provided the current program, written to the Division's specifications.

Tom, the Office of Publication's Systems Analyst, is concerned with streamlining office functions through computer systems. Bob, a supervisory illustrator, and his Branch Chief, Letitia Cole, are concerned with producing attractive, accurate, legible graphs and charts. All were convinced they were on the right track when they began the project in late 1979.

Defaults for type specifications have been included in the program, but may be easily changed. The default point size is 14 points with 18 points of lead; line length, 45 picas, quad left; type style, News Gothic bold. Bob explained, "We want the type to come off the typesetter exactly as it's positioned. That way we simply overlay it on the graph. But the typesetting equipment limits us to an 8 1/2-inch wide page. Therefore, if the graph is wider than 8 1/2 inches and we require a line of type whose size will exceed this length, we have it set in smaller size and photographically enlarge it. However, we are anticipating new typesetting equipment which will handle a much larger page width; but that's a year or two in coming."

Text may be positioned automatically or through the User-Definable Keys. For instance, to specify the left Y-axis labeling, the operator may key in the minimum, maximum, and the increment, e.g., 0 — 300, 100; the program will automatically calculate the X,Y coordinates for placement of tic values and store them with the data. However, User-Definable Keys are used to position graph legends. The keyed in text may be relocated by 10 of the image area, or by one character, up, down, left, or right.

When the graph parameters and type specifications have been input for the chart(s) and sorted to tape, the operator transmits in tape communication mode over the Option 1.

Specifications Sent to Typesetter Over Option 1

Bob described the configuration and data transfer. "The data from the 4051 is sent through the Intergraphics Intercom 100 and is captured on the screen of the Alpha Key III, where the data is stored. The data can also be stored on the Kennedy magnetic tape transport or the Alpha Key Multi-Set III. If corrections need to be made once data is transmitted from the 4051, they may be made on either of the Alpha Key Terminals. For instance, if I forget to change a point size, I can enter the correction now and the corrected data will be sent to the Intercom/Alpha Key which is able to capture keystrokes from different word processors and terminals, i.e., 4051, and translate them to language the Phototypesetter understands.

"The typesetter operator draws the data off the disk, gives it a code name and

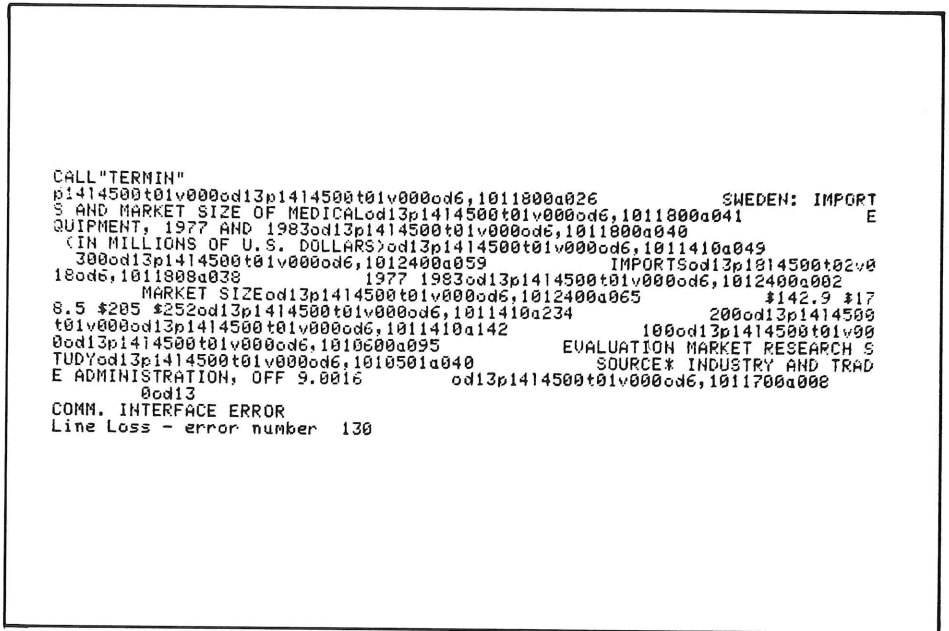

Fig. 2. The typesetting specifications as they are sorted on tape and then transmitted to the phototypesetting drive. The program automatically performs the coding.



Fig. 3. The data from the 4051 is captured on the Alpha Key FDTs III terminal (left) and transferred to the Kennedy drive and tape (right).

sends it to the typesetting processor directly, to another disk, or to a paper tape punch, depending on the state of the processor. If the processor is busy, the data won't go directly to it; a paper tape will be punched and stacked with others. The operator will run them through as needed. There are fourteen different phototypesetting disks. Although it's not difficult to change a disk, the operator will run all requests for the style of type that's on the mounted disk

through at one time. This is where the paper tape comes in handy.

Time and Money Saved

"We have saved a lot of time with the 4051. We don't have to manually spec the manuscript; a typesetter doesn't have to sit down and keyboard it; and we don't have to paste-up the type, piece-by-piece — particularly those tiny vertical numbers along the side. For one



Fig. 4. Once translated by the Kennedy, the typesetting specifications and text data are sent to the Photon typesetting processor.

chart, this may not be economical, but when you're doing four, five or 125, then it's very economical. If we spec the type and send it over in the normal fashion, we're charged per line. Doing it this way, we get a flat rate per chart — much more economical.

"We get the final type on film (Fig. 5). As you can see, it's in position. The only thing we have to do is cut the figures (dollar amounts shown) and space them. Everything else we can just lay on. It saves a lot of pasteup time."

As mentioned earlier, the graphics are sent directly to the 4663 Plotter. Bob will simply overlay the type on the graph and it's done. The time saved? Well, returning to the subject of the White House Economic Charts, Bob said when they were done by hand it was an eight to 12 hour job on one chart. With the 4051 and 4663 they did that job in two hours. He commented, "And the good thing about it is that we get the data printout and it's accurate. When you do them by hand, you get to seeing little dots that aren't there. After five or six hours, you can miss one; a very costly error. The 4051 saves so much time and effort. If you input it right, the 4051 is going to plot it right."

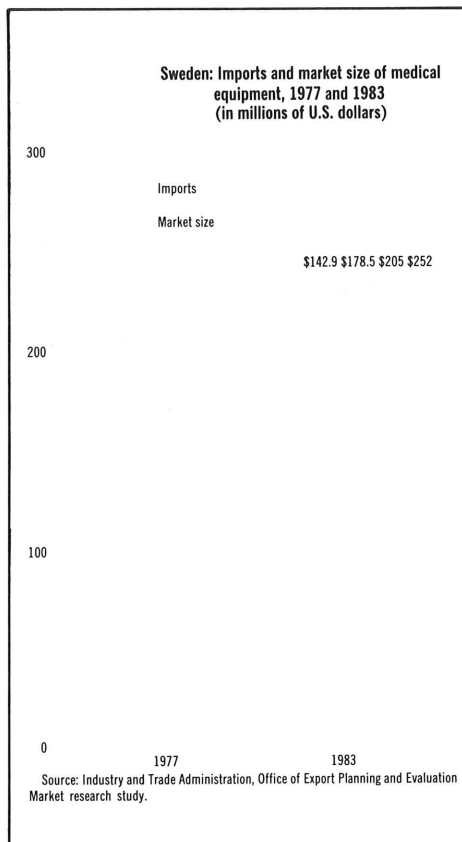

Fig. 5. Except for the dollar amounts, the alpha- numerics are typeset in the correct position to overlay directly on the graph.

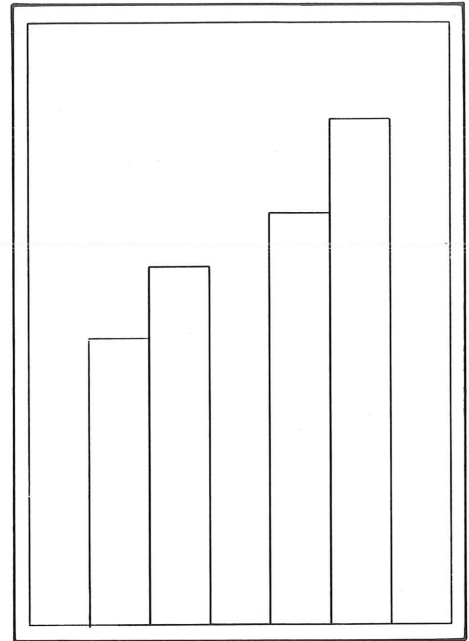



Fig. 6. The graph is produced on the 4663 Plotter.

While their system may not be optimum yet, it's heading in the right direction. Bob credits Tom's experience for part of the success; he's a former printer and programmer. Bob says, "It's kind of hard to find a programmer who knows the graphics-printing trade as well."

Bob also has had programming experience along with his graphics experience. Previously a cartographer for NOAA, he has been in the art production field for about eight years. His computer experience has helped him understand the system and be able to offer constructive changes to the program.

When everything is in place, they estimate it will save the Government approximately \$7,000 to \$10,000 annually. Add this to the time saved — 50 to 80% — and you have a streamlined operation.

Next, the Division plans to adapt the program to produce covers for Commerce's large volume of technical publications. 

INPUT / OUTPUT

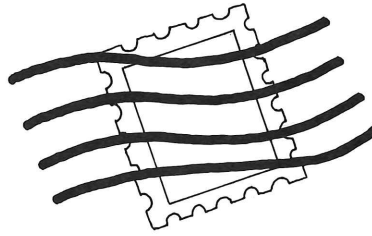

As Technical Support Specialist for the 4050 Series, Howard Sanders has received similar questions from various users concerning the Option 1 RS-232 Data Communications Interface. He, in conjunction with Frank Lees, Communications Support Specialist, has contributed several of the more frequently asked questions and their answers to Input/Output in past issues of TEKniques. While Input/Output will be glad to respond to Option 1 questions from TEKniques readers, perhaps a recently updated publication would be of considerable help.

For example, do you know the difference in local echo/echo plex and compu-

ter-echoed data? Did you know that the half duplex position on a 300-baud full duplex modem usually means local echo and not half duplex operation? These insights and many others are presented in concise, easy-to-understand language, contained in the 46-page booklet.

Entitled "Basic Data Communications," this handy guide was published by Tektronix training specialists and intended to be used with video training tapes. However, it may be purchased separately. It provides the concepts and commonly used terms for a basic foundation in data communications. At the end of each chapter a quiz tests your knowledge.

The table of contents is shown below.

If you would like more information on this publication, ask your local Tektronix Sales Engineer about manual 062-3247-00 (REV 4/80).

BASIC DATA COMMUNICATIONS TABLE OF CONTENTS

| | Page |
|---|------|
| PART I | |
| ENCODING DATA | |
| A. NUMBER SYSTEMS & CODES | |
| 1. BINARY NUMBERS—THE BIT | 4 |
| 2. BINARY CODED DECIMAL (BCD) | 5 |
| 3. OCTAL | 5 |
| 4. HEXADECIMAL | 5 |
| 5. ASCII | 5 |
| B. DEFINITIONS | |
| 1. CHARACTERS | 6 |
| 2. WORDS | 6 |
| 3. BYTES | 6 |
| 4. AVOIDING CONFUSION | 6 |
| C. PARITY | |
| PART II | |
| TRANSMITTING DATA | |
| A. DATA FORMATS | |
| 1. PARALLEL | 14 |
| 2. SERIAL | 14 |
| 3. PARALLEL BY BIT—SERIAL BY CHARACTER | 15 |
| 4. SERIAL TO PARALLEL CONVERSION | 15 |
| B. DATA TRANSMISSION CONCEPTS | |
| 1. SYNCHRONIZATION | 16 |
| 2. SYNCHRONOUS PROTOCOL | 16 |
| 3. ASYNCHRONOUS PROTOCOL | 17 |
| 4. BAUD/BITS PER SECOND/DATA RATE | 17 |
| 5. LINE LENGTH VS DATA RATE | 18 |
| C. DATA TRANSMISSION SYSTEMS—HARDWIRED | |
| 1. LINE DRIVERS & SHORT HAUL MODEMS | 18 |
| 2. CURRENT LOOP SYSTEMS | 18 |
| D. DATA TRANSMISSION SYSTEMS—PHONE LINE | |
| 1. MODEM CONCEPTS | 18 |
| 2. PHONE LINES | 19 |
| 3. BASIC FULL DUPLEX OPERATION | 20 |
| 4. BASIC HALF DUPLEX OPERATION | 21 |
| 5. EIA RS-232C | 21 |
| 6. LOCAL ECHO/ECHO PLEX | 22 |
| 7. BREAK | 23 |
| 8. TYPE AHEAD | 22 |

BASIC DATA COMMUNICATIONS TABLE OF CONTENTS (cont)

| | Page |
|---|------|
| PART III | |
| RS-232C STANDARDS AND INTERFACE IMPLEMENTATIONS | |
| A. RS-232C | |
| 1. HISTORY | 29 |
| 2. CONCEPTS | 29 |
| 3. BASIC OPERATION | 30 |
| B. OPERATING MODES | |
| 1. BASIC RS-232C INTERFACE | 31 |
| 2. RS-232C WITH SUPERVISOR/REVERSE CHANNEL | 31 |
| 3. SYNCHRONOUS | 31 |
| 4. HALF DUPLEX BLANKING | 32 |
| 5. RS-232C DIRECT TO COMPUTER | 32 |
| 6. RS-232C PARALLEL | 32 |
| 7. RS-232C IMPLEMENTATIONS | 33 |
| C. TEKTRONIX 4010 SERIES GRAPHIC TERMINAL STANDARD DATA COMMUNICATIONS IMPLEMENTATION | |
| 1. FULL DUPLEX OPERATION | 33 |
| D. TEKTRONIX 4010 SERIES GRAPHIC TERMINAL OPTIONAL DATA COMMUNICATIONS IMPLEMENTATION | |
| 1. FULL DUPLEX | 34 |
| 2. HALF DUPLEX OPERATION | 34 |
| 3. HALF DUPLEX SUPERVISOR | 35 |
| E. TYPICAL DATA COMMUNICATIONS SYSTEMS | |
| 1. LOW COST 300 BAUD FULL DUPLEX | 35 |
| 2. MODERATE COST 1200 BAUD HALF DUPLEX | 36 |
| 3. MODERATE COST 1200 BAUD HALF DUPLEX WITH REVERSE/SUPERVISOR CHANNEL | 36 |
| 4. STATE OF THE ART 1200 BAUD FULL DUPLEX | 36 |
| 5. MODERATE TO HIGH COST 4800 BAUD SYNCHRONOUS | 36 |
| 6. LOW COST 9600 BAUD LIMITED DISTANCE SYSTEM | 36 |
| F. SYNCHRONOUS MODEMS | |
| 1. CONCEPTS | 37 |
| 2. INTERFACE COMPATIBILITY | 38 |
| 3. COMPUTER MODIFICATIONS | 38 |
| 4. MODEM COMPATIBILITY | 38 |
| 5. LIMITED DISTANCE OR SHORT HAUL MODEMS | 39 |
| PART IV | |
| POLLING & MULTIPLE TERMINALS SYSTEMS | |
| A. CONCEPTS | |
| 1. DEVICE ADDRESSING | 45 |
| 2. BUFFERING | 45 |
| 3. ERROR CHECKING | 45 |
| 4. LOCAL CONTROLLER | 45 |

ACTUAL HARD COPY BY THE
4611 HARD COPY UNIT AND
THE 4052 DESK TOP
COMPUTER

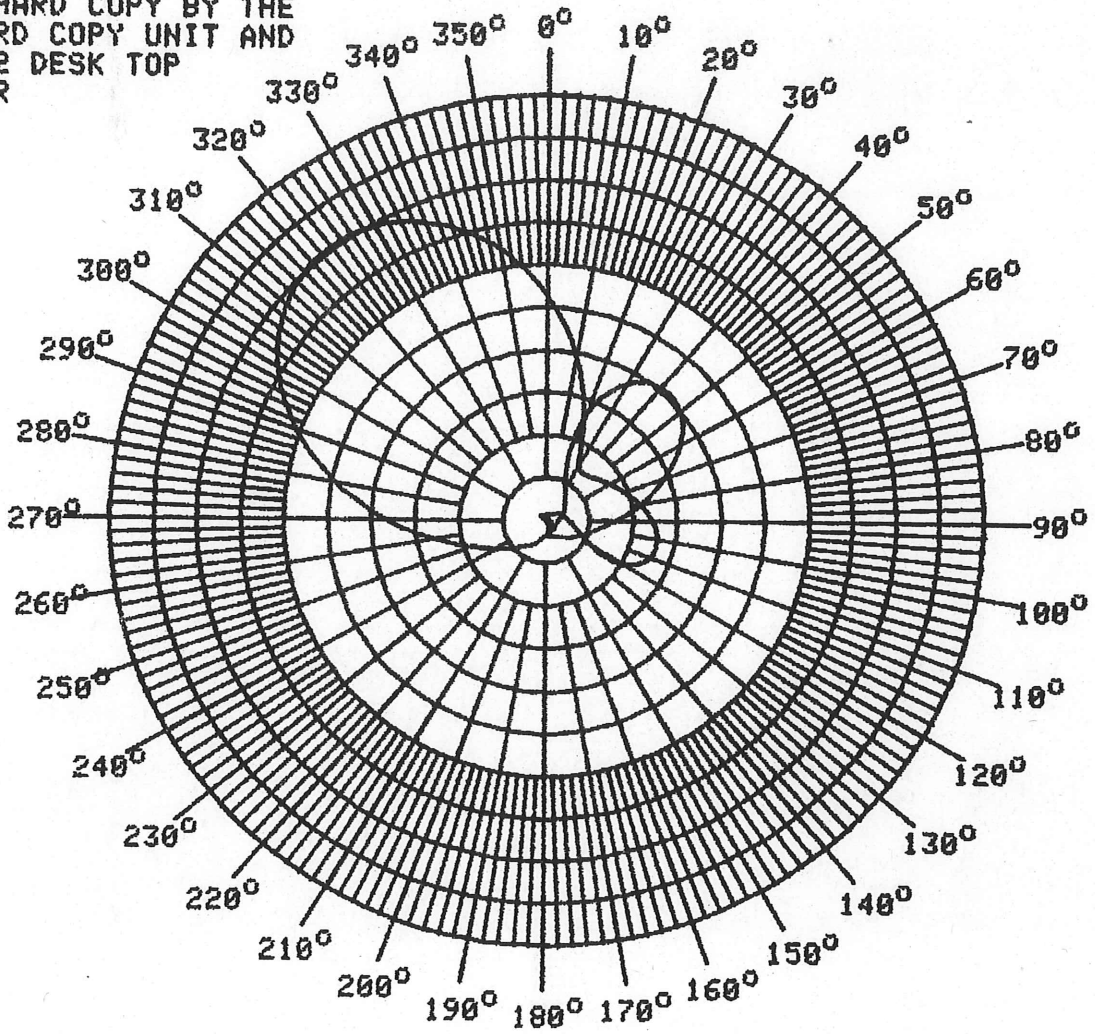

Tektronix Expands Its Family of Graphic Copy Devices

by Cathy Cramer
Tektronix, Inc.
Wilsonville, OR

We're happy to announce the 4611 and 4612 Hard Copy Units, two new members in our family of graphic output devices. The 4612 Video Hard Copy Unit joins the 4632 and 4634, for copying raster scan terminals and other video signal sources. The 4611 joins the 4631, and is designed to copy Tektronix storage tube displays: The 4050 Series of Desktop Computers, as well as the 4010 Series, 4025 and 4081 terminals, and GMA Series display monitors.

The 4611, shown in Fig. 1, is compact and lightweight. Only 16 inches wide and 7 inches tall, it weighs just 45 lbs., and is easy to move from desk to desk. Based on an innovative new implementation of electrostatic technology, the 4611 has been designed from beginning to end with the cost-conscious user in mind. The cost per copy is less than a third that of dry-silver paper. Best of all, in a rare combination of low cost and high performance, the 4611 offers higher image quality than normally found in electrostatic screen copy. (An actual sample 4611 copy has been inserted in this issue of TEKniques.)

How It's Done

Electrostatic technology is a technique involving the transfer of charge to paper. The 4611 process is new, simple and very practical. Inside the 4611, six stainless steel writing styli move along the surface of the paper. The styli move very rapidly on a belt which revolves at a speed of over 300 inches per second. (See Fig. 2) Two of these styli can "write" at any given moment. As the styli move across the paper, two electrodes in direct contact with the opposite side of the paper receive incoming signal information about the image to be copied. When a stylus is positioned in exactly the correct location for an image dot,



Fig. 1. The new 4611 Hard Copy Unit is based on an innovative new implementation of electrostatic technology.

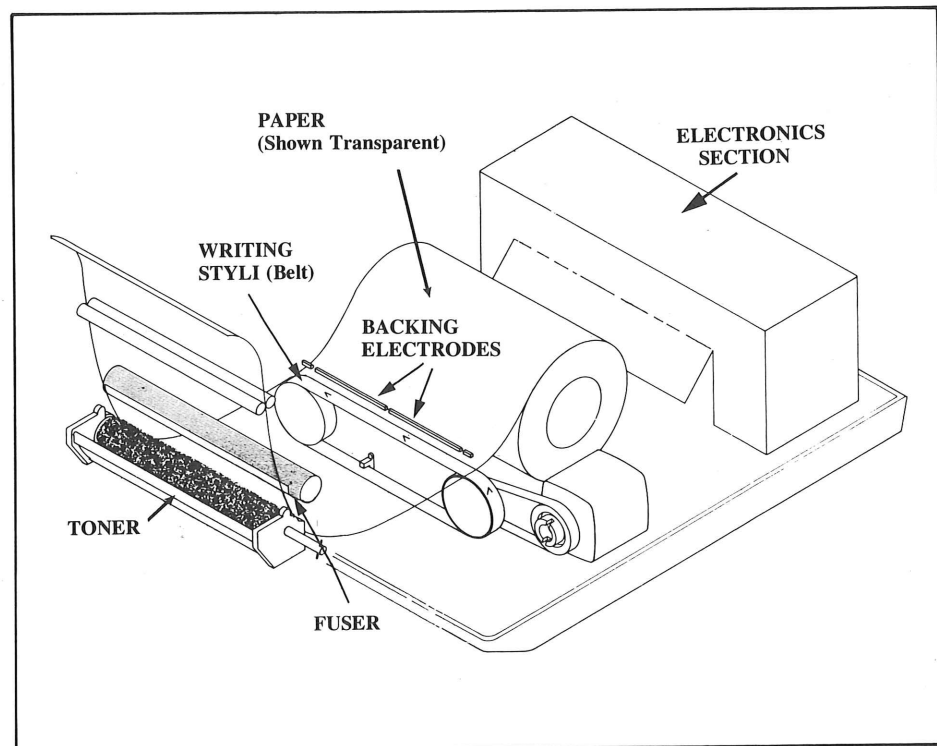

Fig. 2. The TEKTRONIX 4611 Hard Copy Unit - The paper is fed between the backing electrodes and the belt.

the corresponding electrode raises its voltage. The difference in voltage between the electrode and the stylus tip causes a small amount of electric charge to be deposited on the paper.

At this stage the image exists on the paper in the form of an invisible charge. The image becomes visible when the paper passes by a tray of toner, a dry black power containing carbon particles and wax. Finally, a hot metal band melts the wax in the toner: the final touch for a completely permanent and high-contrast image.

The Paper

The electrographic paper used in the 4611 has the look, feel, and handling characteristics of plain bond paper. Although you can barely feel it, the backside of the paper actually has an extremely thin plastic conductive layer, which aids in the charge transfer process. This is the main difference between 4611 paper and plain paper.

Copies can be annotated with any kind of writing medium, including felt tip and other liquid ink pens. Images are perma-

nent and archivable — with no sensitivity to aging at all. And, 4611 copies are very high in contrast. As you can see from the enclosed sample, lines and characters are solid black on a white background.

The Toner

The 4611 is the first desktop terminal copier to use dry toner. Made of inert ingredients, 4611 dry toner is superior to liquid toning methods normally used in electrostatic copying. The dry toner is superior both for the convenience it offers, and for the improved copy quality it provides.

Convenience

The toner is made of carbon, wax, and magnetite. Once every two or three thousand copies it's easy to tap some dry toner into a small front-loading tray. Because of the magnetite, minor spills clean up quickly with an ordinary magnet or magnetic screwdriver.

Image Quality

The dry toner's magnetic properties keep it evenly distributed around its applicator drum. This ensures consistently solid black lines and characters from copy to copy. And, unlike liquid carbon suspensions, the dry toner maintains a consistent composition down to the last copy — no gradual depletion of carbon particles that can cause successive images to become faint and hard to read. And finally, the dry toner allows heat-fusing for complete permanence.

Overall Copy Quality

Despite its low initial and everyday operating costs, the 4611 produces high quality electrostatic copies. This is the result of a combination of two factors which are crucial to overall image quality: addressability, and dot overlap.

Addressability refers to the number of dots that can be placed on a given line or length of line. Generally, the more dot placements allowed, the better the copy quality. The 4611's moving band of writing styli permits very high addressability: 256 dot placements per inch in the horizontal direction, and 171 in the vertical direction. That's over 43,000 dots per square inch!

This is combined in the 4611 with a special dot overlap technique, which allows

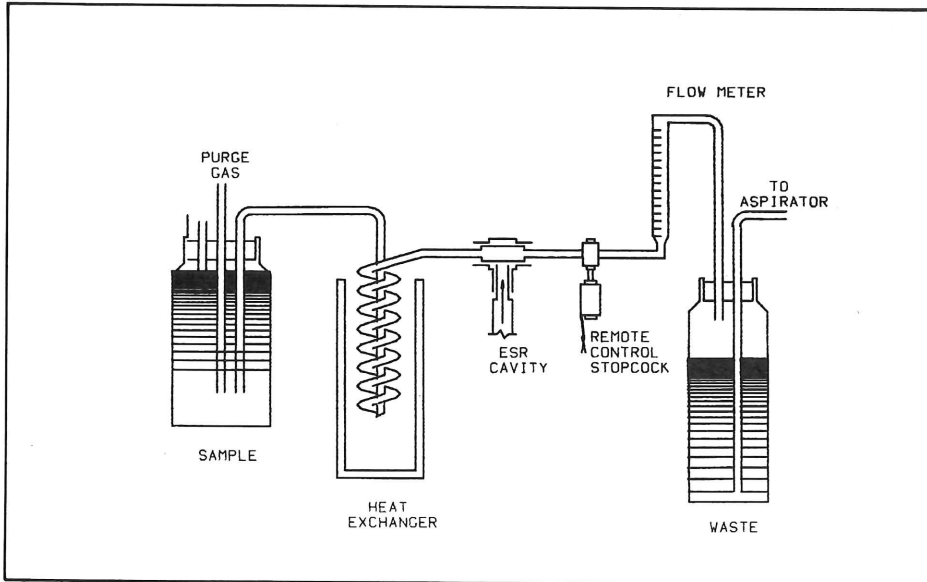

4611 hard copy from the 4054 display.

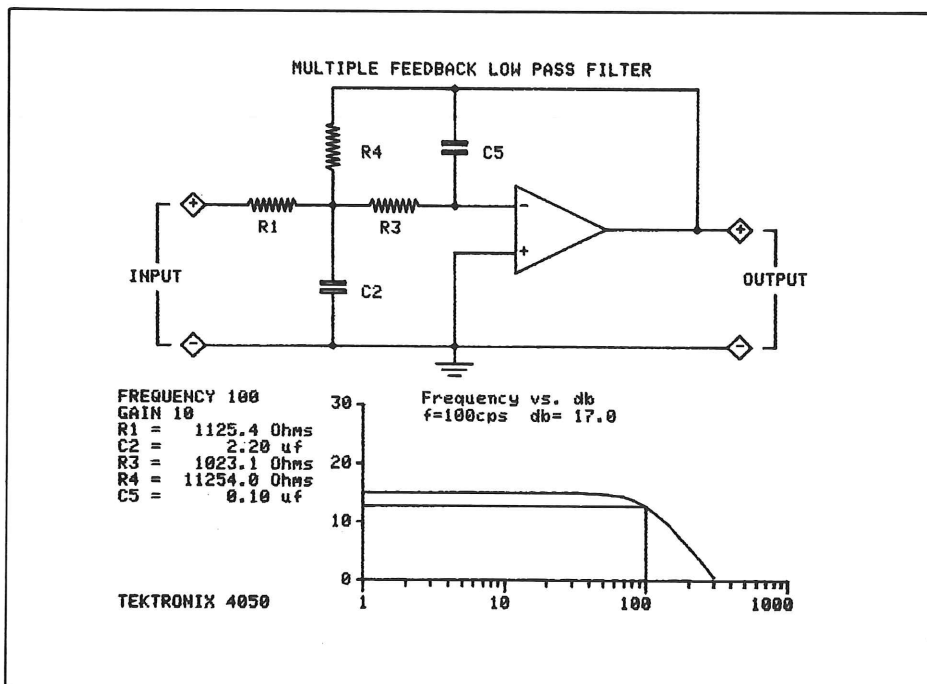

Copied from the 4051 screen by the 4611 Hard Copy Unit.

each dot to overlap its neighbors. Overlapping of dots is necessary for smooth, dark lines and good visual image appearance. If dots *don't* overlap horizontally and vertically, lines and characters are not continuous, and show skips or gaps, especially along diagonal lines. (See Fig. 3.) The 4611 offers a high degree of dot overlap — 67% in the horizontal direction, and 40% in the vertical direction — for denser, darker lines than ever before created using electrostatic techniques. (See Fig. 4.)

A Quick Look at Operational Features

As a final note, here are a few basic operating features. The 4611 copies the same storage tube displays and monitors as the 4631. Like the 4631, it can be multiplexed for sharing between up to four displays at once. The 4611 copies at the press of a single button, with consistent quality and no contrast adjustment knob. Copy time is 24 seconds, for both initial copies and extra copies of the same display. All images are vertically oriented on 8.5 by 11-inch pages, for easy viewing in a standard notebook. Copies are operator-torn against an aluminum cutting edge. Warm-up takes a maximum of about two minutes, and a "ready" light and paper-out indicator are included as standard features. Each unit comes complete with a user's manual, connecting cable, two rolls of paper, and a container of dry toner. Additional accessories and replacement paper and toner are supplied by Tektronix.

For more information or to see additional actual 4611 copies from your 4050 Series Desktop Computer, contact your local Tektronix Sales Engineer. 

Ed. Note: Cathy is product marketing manager for hard copy devices.

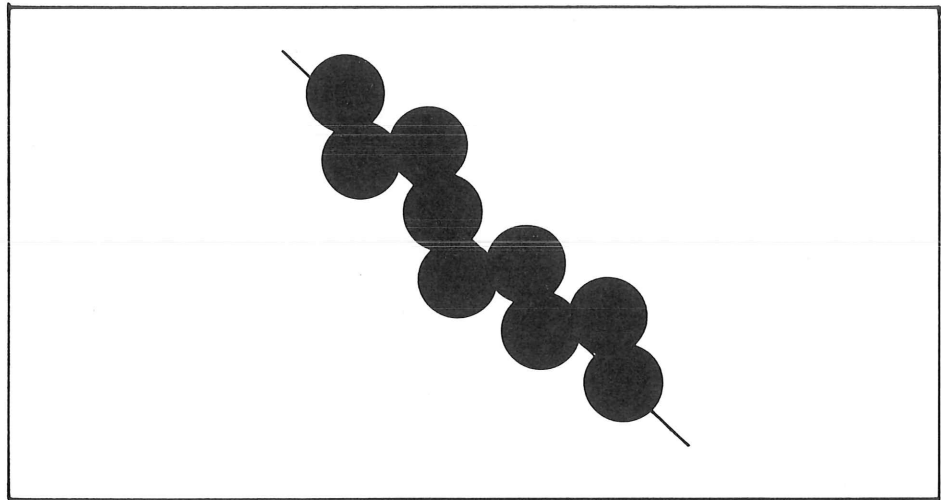

Fig. 3. Without dot overlap, diagonal lines and characters would show what appear to be skips or gaps. (200 by 200 dots per inch, drawn to scale with no dot overlap.)

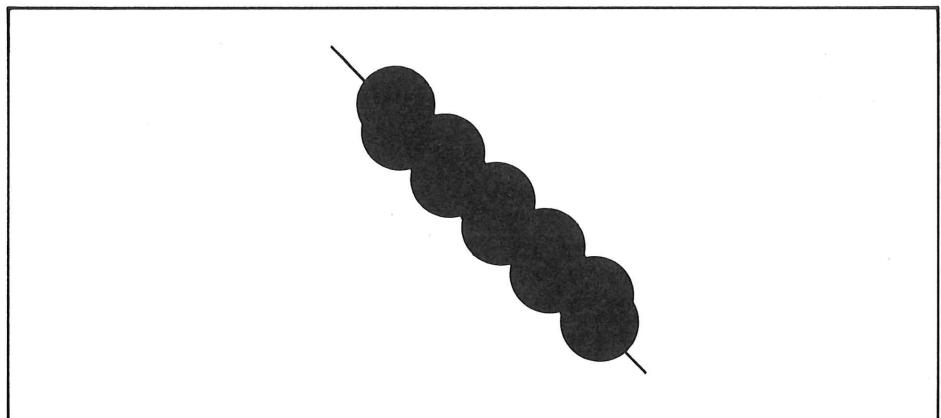
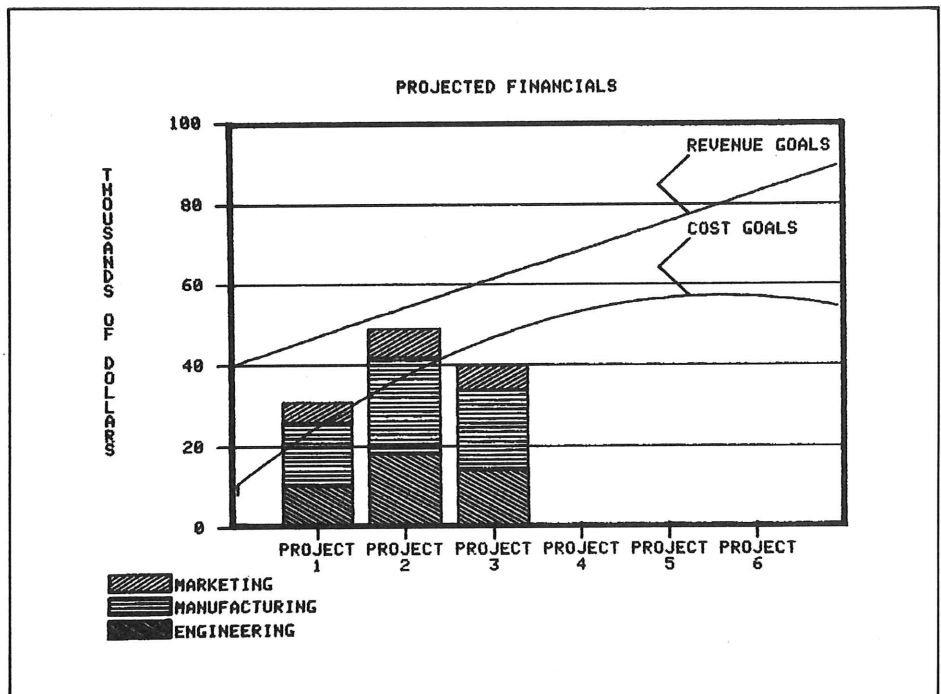

Fig. 4. The 4611 offers a high degree of dot overlap for denser, smoother lines. (256 by 171 dots per inch, drawn to scale with 67% horizontal overlap and 40% vertical overlap.)



Hard copy of a display on the 4052 screen by the 4611

Editor's Note



Catalogs Still Available

Application Library Program Catalogs are still available, and free for the asking. You should have received yours by now, but if you haven't, or if you need additional copies, just drop a line to the Applications Library office serving you. The addresses are listed inside the back cover of this issue.

Looking For Good Tips

Most of us find that there's always room for improving programs and programming techniques. So the Library is always looking for good Programming Tips. If you have a helpful hint about programming, let us know. We'd like to publish it, as a Programming Tip or a BASIC Bit. And you get any one of 14 programs from the library for each of your published Tips or Bits. Details are listed at the end of the BASIC Bits column.

Contest Reminder

Don't forget about the latest Applications Library Contest, announced in TEKniques, Vol. 4, No. 7. The contest subject is In-Depth Graphing, with two categories to stir your imagination. The categories are 2-D Graphing with shading, in which graphs are enhanced to simulate a third dimension, and 3-D Graphing, where three variables are actually plotted on the X, Y, and Z axes.

Submit as many programs as you like, but enter each program in only one category. Programs must run on a 4050 Series Graphic Computing System. Entries must include the program (on tape or disk), the documentation, and a completed and signed submittal form. Submittal forms are available from your local 4050 Series Application Library listed inside the back cover. And for each program you enter, you'll receive your choice of three programs from the Applications Library, so you really can't lose.

There will be first, second, and third place winners in each category. First place winners will get five boxes of tapes or disks, second place — three boxes, and third place — two boxes. And all winners will have the choice of tapes, disks, or a mix of the two. The entry deadline is March 31, 1981, so don't delay. More information about the contest can be found in TEKniques Vol. 4, No. 7.

More Workshop Dates

TEKniques Vol. 4, No. 6 carried a reminder of the 4050 Series Graphic Systems Workshops that are available. These workshops can be a real benefit in helping everyone get the most out of their 4050 System. Here's an extended schedule for the first part of 1981, showing dates and locations of scheduled classes through April. For details on the classes, see the article in TEKniques Vol. 4, No. 6.

Graphic System Workshop Schedule

| | |
|----------------------|-----------------|
| February 9-13, 1981 | Santa Clara, CA |
| March 9-13, 1981 | Santa Clara, CA |
| March 16-20, 1981 | Rockville, MD |
| April 20-24, 1981 | Rockville, MD |
| April 27-May 1, 1981 | Santa Clara, CA |

Don't Miss Out on Applications and Tips

Are you missing any issue of TEKniques? Any of the issues from Vol. 4 are available by calling or writing the Applications Library office serving your area. Issues from Vol. 1-3 are no longer available, but the information has been combined into Application Reprints and a collection of Programming Tips. The following five categories of Application Reprints are currently available:

| | |
|------------------------|---------|
| Engineering and Design | AX-4449 |
| Mapping | AX-4460 |

Data Acquisition and Analysis . . . AX-4450
Business Graphing and

Reporting AX-4451
Peripherals and ROM Packs . . . AX-4452

If you need an article from one of the issues in Volumes 1-3, one of these reprint sets will likely fill your needs. Just contact your local Tektronix office, or the Applications Library serving you, to get your set.

The Programming Tips collection combines 148 tips from the three volumes into one handbook, with a keyword index to help you find what you need. The handbook is available through the Applications Library. U.S. domestic price is \$10.

Need Extra Copies?

Do you need more than one copy of TEKniques on hand, for students, occasional users, coworkers, or others? Just let us know how many you'd like to receive at each publication. In the U.S., call (503) 685-3618.

New Library Prices in Effect

Applications Library prices were last changed in 1978. However, as first announced in TEKniques Vol. 4, No. 7, the following U.S. domestic new prices are in effect beginning Jan. 1, 1981:

| | |
|--------------------------------|-----------|
| Documentation and Listing only | ...\$25 |
| Documentation, Listing and | |
| Recording Fee |\$30 |
| Cartridge Tape | 36 |
| Flexible Disk | 15 |

The increases will apply to all orders received after January 1, 1981. 

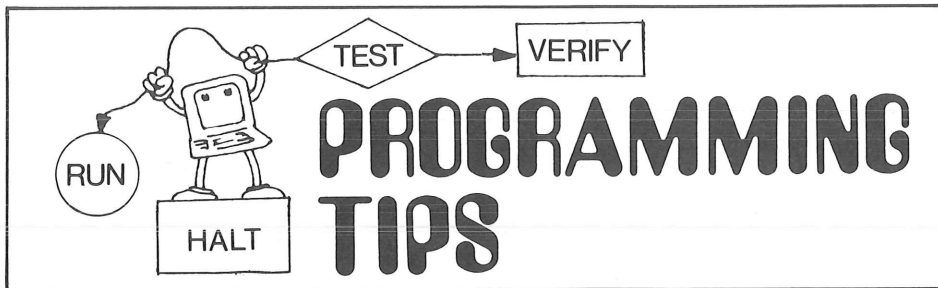

4924/4924 Tape Duplicator

by Mark Mehall
Tektronix, Inc.
Wilsonville, OR

The following is a quick and easy way to duplicate 4051 tapes. The program requires two 4924 drives and uses TALK and LISTEN. The program will copy all files except SECRETed ones. The files can be ASCII or Binary and Programs or Data.

```

100 PRINT "LI4924/4924 TAPE DUPLICATORJJ"
110 PRI "This program will do a fast tape duplication using two 4924's"
120 PRINT "The default addresses are: Master=2 Duplicate=3."
130 PRINT "Change lines 240 and 270 if your units are different.JJ"
140 PRINT "Press RETURN to begin."
150 INPUT R$
160 INIT
170 PRINT @32,26:2
180 REM F is the File Number
190 F=0
200 REM Set up C$ to be the end of the header
210 C$=CHR(13)
220 C$=C$&"S"
230 REM M is the address of the drive with the master tape
240 M=2
250 FIND @M:0
260 REM D is the address of the drive to get the duplicate tape
270 D=3
280 FIND @D:0
290 PAGE
300 REM START THE DUPLICATION
310 REM Set the Master to Non-Header Mode
320 PRINT @M,0:0,0,1,0
330 REM Set the Duplicate to Header Mode
340 PRINT @D,0:0,0,0,0
350 REM Enable the SRQ to process the header
360 ON SRQ THEN 640
370 FIND @M:F+1
380 INPUT @M:H$
390 F=VAL(H$)
400 REM Get the size of the file
410 N$=SEG(H$,35,4)
420 N=VAL(N$)
430 REM And get the file type (ASCII,BINARY,NEW OR LAST)
440 T$=SEG(H$,9,1)
450 REM Set T to 110 for Binary, 100 for everything else
460 T=(T$="B")*2+100
470 PRINT "File: ";F;" length: ";N*256
480 PRINT "Header: ";H$
490 REM Check for last file
500 IF T$="L" THEN 720
510 REM Set the Master to Header Mode
520 PRINT @M,0:0,0,0,0
530 REM Find the file and mark it
540 FIND @M:F
550 FIND @D:F-(F=1)
560 MARK @D:1,N*256
570 REM If file is new then skip it
580 IF T$="M" THEN 720
590 FIND @D:F
600 REM TRANSFER FILE
610 WBYTE %63,95,35,66,T,T+1,121,122:
620 WAIT
630 REM Do UNTALK and UNLISTEN to clear the bus
640 WBYTE @63,95:
650 REM Set the Duplicate to Non-Header mode and output the header
660 REM Do the header
670 PRINT @D,0:0,0,1,0
680 FIND @D:F
690 REM Print the header
700 PRINT @D:H$;C$
710 REM Get the error codes from the drives
720 INPUT @M,30:M1
730 INPUT @D,30:D1
740 REM Check if everything was OK
750 IF M1=0 OR M1=12 AND D1=0 THEN 780
760 REM There is a problem
770 PRINT "PROBLEM...PLEASE CHECK THE TAPES.GGG"
780 IF POS(H$,"last",9)<>0 THEN 800
790 GO TO 310
800 PRINT "Done.GG"
810 REM Rewind the tapes
820 FIND @M:0
830 FIND @D:0
840 PRINT @32,26:0
850 END

```

Sorts — A Synopsis

Many issues of *TEKniques* have carried sorting programs, namely:

| Title | Issue/No. | Handbook Page |
|--|--------------|---------------|
| Numeric Quicker Sort on 4907 Disk Unit | Vol. 1 No. 9 | 21 |
| String Sort | Vol. 3 No. 5 | 85 |
| Butterfly Sort Speeds Alpha String Sorting | Vol. 3 No. 7 | 94 |
| One File Sort on the 4907 | Vol. 3 No. 8 | 104 |
| Butterfly Sort Extended | Vol. 4 No. 6 | |
| Shellsort Where 4051R07 or 4052R07 Not Available | Vol. 4 No. 8 | |
| Update of Quicker Sort | Vol. 4 No. 8 | |

Dan Taylor compared the Butterfly Sort, Vol. 3 No. 7, to the Bubblesort and Quicker Sort.

In the Shellsort routine, Vol. 4 No. 8, Dr. Bernard Gunn commented that Bubblesort is extremely primitive and the original Quicksort is rather complex, used mainly on host computers.

Dr. W.B. Reid provided an update to Quicker Sort, Vol. 4 No. 8. In his letter which contained the tip, Reid mentioned that he had implemented all of the above sorts as well as Quick Sort, Bubble Sort and Heap Sort algorithms. He found, "Quicker sort, although in a totally random set of data is not quite as fast as Quick Sort, it has a rather great virtue of dealing with data which is already essentially in order much more efficiently than the "textbook-described" Quick Sort algorithm. Quick Sort, rather than taking less time on well-ordered data, takes considerable more time, and in fact, is extremely poor on data which might accidentally be in order."

A Dutch reader has now dissected the Bubble Sort-Shell Sort routines in his programming tip "Shellsort Revisited" in this issue.

Pointing out a sort routine's special advantages helps a user match it to their requirements. If anyone has other sort routines implemented on the 4050 Series, send them in with a note on the special features of the sort. It will gain you documentation and listing for one of the programs listed at the end of the BASIC Bits.

Shellsort Revisited

by A.C. Visser
Institute for Land and Water
Management
Wageningen, The Netherlands

Bubble Sort wastes a lot of time in bubbling entries up which are far from their correct position. So Bubble Sort is most efficient, when the entries to be sorted are already partially sorted and near to the correct place. The average number of comparisons for (for large n) is Bubble Sort $n/4$.

Shell Sort (named after its creator, D.L. Shell — 1959 —) uses the idea that Bubble Sort is fastest when no entry is very far from its correct position. So Shell Sort starts to compare entries on a large distance (first step $d_1 = 2^{k-2}$; $2^k < n < 2^{k+2}$, n length of table) and on each successive pass the distance is computed according to the rule $d_{i+2} = (d_i - 1) / 2$. So the last pass is a Bubble Sort. The theoretical number of comparisons required by Shell Sort has never been worked out analytically, as far as I know, but empirical studies show that the number of comparisons needed rise slightly faster with n than $n \log n$. Thus Shell Sort is extremely fast and like Bubble it requires no extra storage and is easy to implement.

A comparison of the example with an array of 100 entries gives:

Bubble Sort $100 / 4 = 2500$ comparisons
Shell Sort $100 \log 100 = 200$ comparisons

So Shell Sort is about 12 times faster for 100 entries.

```

1000 REM This routine is based on an algorithm proposed
1010 REM by D.L. Shell in 1959, known as Shellsort.
1020 REM It is more recently described in A.T. Bertziss
1030 REM "Data Structures, Theory and Practice" in
1040 REM Computer Science and Applied Mathematics (1971)
1050 REM ***** INPUTS *****
1060 REM   Array C, to be sorted
1070 REM   L4: L4+1 first element to sort
1080 REM   L1: L4+L1 last element to sort
1090 REM If all elements have to be sorted then
1100 REM L4=0
1110 REM L1=length of array C
1120 REM Optional rearrangement of second array N
1130 REM with the same permutations as C
1140 REM If you don't want this feature,
1150 REM remove lines 1430, 1450 and 1470
1160 REM
1170 REM ***** OUTPUTS *****
1180 REM   Array C: sorted
1190 REM   Optional array N
1200 REM   L1, L4 unchanged
1300 L2=1
1310 L2=2*L2
1320 IF L2<=L1 THEN 1310
1330 L2=INT((L2-1)/2)
1340 IF L2=0 THEN 1530
1350 L3=L1-L2
1360 FOR R=1 TO L3
1370 K=R+L4
1380 J=K+L2
1390 REM
1400 REM For decreasing order change => in =<
1410 REM
1420 IF C(J)>C(K) THEN 1510
1430 N1=N(K)
1440 C1=C(K)
1450 N(K)=N(J)
1460 C(K)=C(J)
1470 N(J)=N1
1480 C(J)=C1
1490 K=K-L2
1500 IF K>L4 THEN 1380
1510 NEXT R
1520 GO TO 1330
1530 RETURN

```

Precursive Equations for Fast Circles

by Dony Robert
Brussels, Belgium

The following small program permits circle drawing much faster than the method described in the PLOT 50 manual "Introduction to Graphic Programming in Basic — page 5-24".

For example a circle with center (X0,Y0) with radius R, for each point P of that circle we have:

$$X - X0 = R.\cos A$$

$$Y - Y0 = R.\sin A$$

with each increment of angle A with quantity dA we obtain the point P defined by the equations

$$X1 = X0 + R.\cos (A + dA)$$

$$Y1 = Y0 + R.\sin (A + dA)$$

Using the well know equations of trigonometry

$$\cos(a+b)=\cos a.\cos b - \sin a.\sin b$$

$$\sin(a+b)=\sin a.\cos b + \cos a.\sin b$$

we obtain

$$X1=X0+R.\cos A.\cos dA - R.\sin A.\sin dA$$

$$Y1=Y0+R.\sin A.\cos dA + R.\cos A.\sin dA$$

but $R.\cos A=X-X0$ and $R.\sin A=Y-Y0$

resulting in

$$X1=X0+(X-X0).\cos dA - (Y-Y0).\sin dA$$

$$Y1=Y0+(Y-Y0).\cos dA + (X-X0).\sin dA$$

So we can start the transfer of the circle beginning at any point; the subsequent points will be calculated by means of equations mentioned above, once we calculate $\cos dA$ and $\sin dA$. This eliminates the calculations of the trigonometry of each point of the circle, and speeds the circle drawing.

For example, here are 2 programs tested for $dA=1^\circ$

Fig. 1. Uses parametric equations and needs 60 sec. on the 4051.

Fig. 2. Uses precursive equations and needs 41 sec. on the 4051.

Editors Note: Either of these routines takes approximately 5 seconds on the 4052.

For repeatedly drawn circles, the coordinates could be plotted from an array at a significant time saving. See the programming tip "4051 FAST Graphics" contained in *TEK-niques Vol. 2 No. 2*, or in the *Programming Tip handbook page 36*.

```

100 INIT
110 REM Initialize
120 SET DEGREES
130 PAGE
140 DATA -5,3,10,1
150 READ X0,Y0,R,A
160 WINDOW X0-R,X0+R,Y0-R,Y0+R
170 UIENPORT 15,115,0,100
180 AXIS A,A,X0,Y0
190 REM Circle Generation: Program 1
200 MOVE X0+R,Y0
210 FOR I=A TO 360 STEP A
220 X1=X0+R*COS(I)
230 Y1=Y0+R*SIN(I)
240 DRAW X1,Y1
250 NEXT I
260 HOME
270 END

```

```

100 INIT
110 REM initialize
120 SET DEGREES
130 PAGE
140 DATA -5,3,10,1
150 READ X0,Y0,R,A
160 WINDOW X0-R,X0+R,Y0-R,Y0+R
170 UIENPORT 15,115,0,100
180 AXIS A,A,X0,Y0
190 REM Circle generation: Program 2
200 C=COS(A)
210 S=SIN(A)
220 X=X0+R
230 Y=Y0
240 MOVE X,Y
250 FOR I=A TO 360 STEP A
260 X1=X0+(X-X0)*C-(Y-Y0)*S
270 Y1=Y0+(Y-Y0)*C+(X-X0)*S
280 DRAW X1,Y1
290 X=X1
300 Y=Y1
310 NEXT I
320 HOME
330 END

```

Renaming Tape File Headers

by Herman D'Hondt
Tektronix, Inc.
Sydney, Australia

There appears to be confusion about the "renaming" of tape file headers. The situation is quite flexible. Most characters in the header can be changed, and some of them can be numeric. The following restrictions apply:

- 1) Positions 1 to 4 are reserved for the file number.
- 2) Character 9 must be A (ASCII), B (binary), N (new) or L (last). The wrong character here will generate an error when the file is accessed.
- 3) Character 17 is normally P (program), D (data), T (text) or L (log). However, the only requirement is that the character has be P if the file is to be "autoloaded." In all other cases, it can be any printing character.
- 4) Character 27 must be an S when and only when the file contains a secret program.
- 5) Positions 35 to 42 are reserved for the file size in physical records when a MARK command is performed.
- 6) Numerics in positions 15 to 33 could cause problems. When the 4050 marks a file, it prints the number of physical records in that file on the header, e.g., number 7 would indicate 7 physical records or 256*7 bytes of file length. During a TLIST or when a program is being saved or data is being written to a file, the 4050 calculates the length of the file from the header. It does this by performing a VAL function on the segment of header containing bytes 15 to 42. The VAL function selects the first numeric digit(s) it comes to. Consequently, if the header were changed to reflect an 8 in byte 23, the 4050 would calculate that the file was 8*256 or 2048 bytes long. However, the actual marked length could be entirely different.

If these restrictions are observed, anything else goes. The following program allows you to enter up to 23 characters, starting at position 10. It checks for the above restrictions, and automatically prints CR, CONTROL-S after the header.

And remember that the physical header is 256 bytes long, only 44 of which are

used. The rest can be anything you want. See the Programming Tip in Vol. 3 No. 3 "Extending the Tape File Header" (Programming Tip handbook p. 78). Also, refer to the abstract describing program 51/00-8039/00 in the Applications Library.

```
100 INIT
110 PRINT "LITAPE HEADER LABELING PROGRAM"
120 PRINT "I=====I"
130 PRINT "This program inserts labels in the headers of tape files."
140 PRINT "You can insert up to 22 characters in each header. These "
150 PRI "can be any printing character, subject to the following rules:"
160 PRINT "  1. Positions 15 to 32 cannot have numbers."
170 PRINT "  2. AUTOLOAD programs must have a 'P' in position 17."
180 PRINT "  3. An 'S' in position 27 assumes the program is Secret."
190 PRINT "The 4050 will not be able to load it unless it is."
200 PRINT "If you violate any of these rules, the program will take"
210 PRINT "appropriate action."
220 PRINT "To end, enter '0' for the file number."
230 DIM Z$(1),N$(23),P$(1),Q$(1),R$(1),C$(2),S$(2)
240 C$=CHR(13)
245 S$=CHR(19)
250 C*=C$&S$

260 REM *** REQUEST FILE # & NAME ***
270 PRINT "ENTER FILE # ";
280 INPUT N
290 IF N=0 THEN 700
295 PRINT "      B"
300 PRINT "      A          P          S"
310 PRINT "XXXXXXXXXX01234567890123456789012XXXXXXXXXXXX"
320 PRINT "JJENTER FILE NAME KKK"
325 PRINT " /";
330 PRINT USING "24<"H">S": "
340 N$=""
350 INPUT M$
360 N$=REP(M$,1,LEN(M$))

370 REM *** READ TAPE HEADER ***
380 PRINT @33,0:0,0,1
390 FIND N
400 INPUT @33:A$
410 Q$=SEG(A$,17,1)
420 R$=SEG(A$,27,1)
430 A$=REP(N$,10,LEN(N$))

440 REM *** CHECK FOR SECRET PROGRAMS ***
450 M$=SEG(A$,27,1)
460 IF M$="S" AND R$<>"S" THEN 680
470 IF R$="S" AND M$<>"S" THEN 720

480 REM *** CHECK FOR NUMERICS ***
490 M$=SEG(A$,15,19)
500 M$=M$&"1.234E-234"
510 IF VAL(M$)=1.234E-234 THEN 550
520 PRINT "JJJCAN'T HAVE NUMBERS IN POSITIONS 15 TO 33. TRY AGAIN."
530 GO TO 300

540 REM *** CHECK FOR AUTOLOAD PROGRAM ***
550 P$=SEG(A$,17,1)
560 IF Q$<>"P" OR N<>1 OR P$="P" THEN 610
570 PRINT "JJJAUTOLOAD PROG NEEDS 'P' IN POS 17, WANT TO CHANGE IT? ";
580 INPUT Z$
590 IF Z$="Y" THEN 300

600 REM *** REPLACE HEADER ***
610 FIND N
620 A$=A$&C$
630 PRINT @33:A$
640 CLOSE
650 PRINT @33,0:0,0,0
655 PRINT "L"
660 GO TO 220

670 REM *** ERROR MESSAGES AND END ***
680 PRINT "JJJYOU'RE ABOUT TO MAKE THAT FILE SECRET. PLEASE TRY AGAIN"
690 GO TO 300
700 FIND 0
710 END
720 PRINT "FILE IS SECRET, CHAR #27 SHOULD BE 'S'. PLEASE TRY AGAIN."
730 GO TO 300
```

Verifying Tapes

by David Bruning
Las Cruces, NM

The PLOT 50 "verifier" mentioned in TEKniques Vol. 2 No. 5 runs 25 minutes. If you have 100 data tapes, it would require a minimum of one work week to verify them.

The following "quick" routine will catch almost all errors attributable to the tape. The nature of the tape errors explains the success of the routine. Most "hard" errors will be found by any routine which searches for an interfile gap. "Soft" errors are usually caused by excess oxide, which, if not overly excessive, is removed by head contact. Writing on each available inch of tape is not necessary to correct these kinds of "soft" errors, but merely marking and rewinding will generally suffice. The quick routine will catch most errors, but only bit verify 5% of the tape.

The intermediate routine will catch most remaining errors by verifying 57% of the tape. Full verification will bit verify 100% of the tape, but will be slower by factors of roughly 1:3 and 2:3, respectively.

The question is not, "Do I verify", but rather, "How much?"

Of course more esoteric tape problems, which are comparatively rare, need to be checked out by a more complete verification routine — such as the one in PLOT 50 General Utility programs. And for data that requires a 100% zero error verification, quick routines are not suitable. But non-zero error verification may well make use of the quicker routines with a savings factor of 2 to 4 in time.

Quick verification is achieved through the MARKing of 100 files of 2560 bytes in length each. Read/write errors are tested for by finding each file in reverse order. This latter process also cycles a new tape before its first use and rewinds the tape. The large number of files and small file size permit a uniform testing of the tape surface.

Intermediate verification marks 10 files and writes binary ones throughout each of them. The files are read to check for tape errors, and then killed to restore the tape to NEW status.

Typical run times are:

| | |
|---------------------------------|------------|
| Quick Verification | 5 minutes |
| Intermediate without read check | 12 minutes |
| Intermediate with read check | 18 minutes |

Tape errors are related by the system error messages.

Error Message

53

What To Do

Read/write error. Clean recording head of the magnetic tape unit; try again. If second attempt results in same message, don't use the tape.

54

EOT has been reached. This is a short tape; return it to the vendor.

56

Tape is SAFE. Rotate the lockout plug and try again.

63

Header error. Try cleaning the tape head and run the program again. If it aborts a second time with this same error, there may be a machine malfunction. Contact the key operator.

Tape winds one end off of spool (no error message).

Bad tape window, or no BOT-EOT tape signals. Return tape to vendor. Repeated occurrences may indicate a hardware problem in the tape unit. Contact your local Tektronix Service Specialist.

Editor's Note: Statement 220 marks approximately 280,000 bytes — 100 files at 2560 each plus 256 bytes for each header. Reading the file (statement 550) forces the 4050 to a checksum.

Dave worked for Lockheed Electronics Company at the time the programming tip was contributed. He pointed out that they use approximately 300-400 data tapes which preclude using the 100% tape verification routine in the PLOT 50 program for all but the most critical data. Dave also contributed an application article printed in TEKniques Vol. 2 No. 6 "An Interface for Data Transfer Between CDC 3000 Series Computer and a 4051." He has since returned to New Mexico State University, Dept. of Astronomy, to pursue his Ph.D.

All Tektronix tapes are certified. However, it is very important that new tapes be cycled at least once; twice is preferable. To do this: FIND 2, FIND 0, FIND 2, FIND 0. 

```
100 PRINT "LTape Verification Routine"
110 PRINT "JInsert new tape in internal tape drive"
120 PRINT "Input 1 for quick verification";
130 PRINT " 2 for full verification ";
140 DIM A$(1),B$(1)
150 INPUT A
160 IF A=2 THEN 350

170 REM Quick Tape Verification
180 REM Find the beginning of the tape
190 FIND 0
200 REM Mark 100 files
210 MARK 100,2560
220 PRINT "GGG"
230 REM Find files in reverse order
240 FOR I=100 TO 1 STEP -1
250 FIND I
260 NEXT I
270 PRINT "Quick verification completedGGG"
280 PRINT "Do you wish to Verify another tape? (Y or N) ";
290 INPUT A$
300 IF A$="N" THEN 340
310 PRINT "Insert new tape - press RETURN to continue"
320 INPUT A$
330 GO TO 180
340 END

350 REM - Intermediate tape Verification
360 PRINT "Do you wish to check READ/WRITE? (Y or N) ";
370 INPUT B$
380 DIM X(2969)
390 FOR I=1 TO 10
400 IF I<>1 THEN 450
410 REM Find the beginning of the tape
420 FIND 0
430 GO TO 460
440 REM - Mark one file
450 FIND I
460 MARK I,2969
470 REM - Fill file with binary 1's
480 FIND I
490 X=0.1
500 WRITE X
510 REM - Read file and test for completeness of data
520 FIND I
530 READ @33:X
540 IF B$="n" THEN 610
550 Y=0
560 Y=SUM(X)
570 IF Y=2969 THEN 610
580 PRINT "READ/WRITE ERROR in file #";I
590 PRINT "Job terminated -"
600 END
610 PRINT "File number ";I;" OK"
620 NEXT I
630 FOR I=10 TO 1 STEP -1
640 REM - Restore file to new status
650 KILL I
660 NEXT I
670 FIND I
680 PRINT "Intermediate verification completedGGGGGGGGG"
690 PRINT "Do you wish to verify another tape? (Y or N) ";
700 INPUT A$
710 IF A$="N" THEN 750
720 PRINT "Insert new tape - press RETURN to continue"
730 INPUT A$
740 GO TO 390
750 END
```

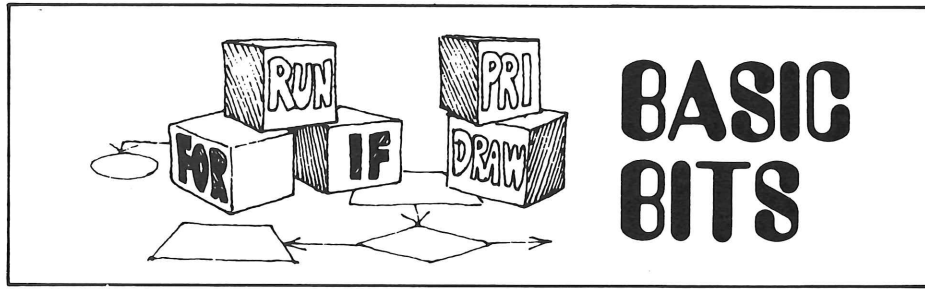

Determining Unused Space on a Tape

by Brad Finney
Humboldt State University
Arcata, CA

This program determines the total number of bytes currently marked on a tape. It will also display the LAST file number. The program could be used to determine whether a particular program would fit on a nearly full tape.

Editor's Note: The program checks each file's header for the number of physical records printed in it and multiplies this by the number of bytes in a physical record, i.e., 256. What also must be taken into consideration is how many files are on the tape and the number of bytes "lost" between files (see TEKniques Vol. 2 No. 5 "Verifying Ensures High Quality Tape Recording Surface" or Programming Tip handbook, p. 49). Each interfile gap is approximately 3 1/2 inches and there are about 200 bytes per inch.

This program is very useful for determining the maximum size file that could be marked on a tape. A related program is contained in the PLOT 50 General Utility programs — Extended TLIS. This program is useful if you are duplicating a tape and want to know exactly how many bytes of each file are actually used, and mark the new files accordingly.

```

100 PRINT '*** TAPE STORAGE SIZE COUNTER ***'
110 PRINT 'THIS PROGRAM DETERMINES THE TOTAL NUMBER OF BYTES CURRENTLY'
120 PRINT 'ALLOCATED ON A TAPE . THE PROGRAM ALSO OUTPUTS THE 'LAST' ;'
130 PRINT 'FILE NUMBER.'
140 PRINT 'INSERT TAPE AND TYPE A CARRIAGE RETURN'
150 INPUT D#
160 PRINT @33;0;0,0,1
170 T=0
180 F=1
190 FIND F
200 INPUT @33;H#
210 D#=SEG(H#,9,1)
220 IF D#='L' THEN 280
230 D#=SEG(H#,35,5)
240 T=T+VAL(D#)*256
250 F=F+1
260 GO TO 190
270 T=300000-T
280 PRINT 'ASSUMING 256 BYTES/RECORD, THERE ARE ;T; BYTES ;'
290 PRINT 'CURRENTLY ALLOCATED'
300 PRINT 'ON THE TAPE. SINCE MAXIMUM TAPE STORAGE IS APPX. 300,000 ;'
310 PRINT 'BYTES, AN'
320 T=300000-T
330 PRINT 'ADDITIONAL ;T; BYTES COULD BE STORED ON THE TAPE.'
340 PRINT 'THE FILE NUMBER OF THE 'LAST' FILE IS ;F'
350 PRINT @33;0;0,0,0
360 END

```

New Set of Programs for Programming Tip Exchange Plus a Copy of Tip Handbook

With the new year comes a new set of programs from which you may choose your exchange program for your tip. Send in your programming tip and receive the documentation and listing for one of the programs listed plus a copy of the Programming Tip Handbook (51/00-7004/0).

Programming Tip Exchange

| | | | |
|--------------|---|--------------|--|
| 51/00-0720/0 | Machinery Cost Analysis | 51/00-8032/0 | Device Address Adding Program |
| 51/00-0902/0 | Calendar Routines (7 Day) | 51/00-8039/0 | Tape File Header Expander |
| 51/00-1203/0 | Planimeter | 51/00-9516/0 | Advanced Media Graphics |
| 51/00-1605/0 | Shear and Moment Diagrams for Determinate Beams | 51/00-9527/0 | 3-D Transformation |
| 51/00-5506/0 | 3-D Function Plot | 51/00-9534/0 | Q-Plot |
| 51/00-6102/0 | Hewlett Packard I/F Package | plus | |
| 51/00-6109/0 | Inventory File System | 51/00-7004/0 | Programming Tips  |
| 51/00-8028/0 | Change & List Program Variables | | |

4050 Series Applications Library Program Abstracts

Order

Documentation and program listings of each program are available for a nominal charge. Programs will be put on tape or disk for a small recording fee per program plus the charge for the tape cartridge or flexible disk. One tape/disk will hold several programs. Programs will be recorded on like media only, i.e., programs on tape cannot be sent on disk and vice versa unless so noted in the abstract.

(The program material contained herein is supplied without warranty or representation of any kind. Tektronix, Inc. assumes no responsibility and shall have no liability, consequential or otherwise, or any kind arising from the use of this program material or any part thereof.)

Domestic U.S. Prices:

| | |
|--|------------------|
| Documentation and Listing only | \$25 per program |
| Documentation, Listing and Recording Fee | 30 per program |
| Tape Cartridge | 36 per tape |
| Flexible Disk | 15 per disk |

Contribute

Contribute one program to the Library and receive three in exchange. Send in the membership card from your 4050 Series Graphic System Reference Manual to get the details. Or call us (503) 685 3618.

Forms

Please use the Applications Library Order Form. Order forms are included in the Membership Packet and are available from your local Tektronix Sales Engineer.

Outside U.S.

Program contributions or orders outside the U.S. must be processed through the local Tektronix sales office or sent to one of the Libraries serving your area. See Library Addresses section.

Correction to 51/00-8004/0

The popular Cross-Reference & List Program Variables program requires the following change to run properly on the 4052/4054. Change statement 2610:

from: 2610 N\$=REP(J\$, J6+9, 6)

to: 2610 N\$=REP(J\$, INT(J6)+9, 6)

ABSTRACT#: 52/00-8046/0

Title: Super Font

Author: Jon C. Mutton

Tektronix, Inc.
Wilsonville, OR

Memory Requirement: 64K

Peripherals: Optional

4662/4663 Plotter

Files: 2 ASCII Program

17 ASCII Data

You may use 14 different character fonts, three symbol fonts and several composing modes to produce a sign or message. The display is previewed on the 4052/54 screen, then copied or sent to the 4662/4663 Plotter. The character fonts include:

Gothic Light
Gothic Medium
Greek Gothic
Script Light
Script Medium
Roman Medium
Roman Bold
Roman Italic Medium

Roman Italic Bold

Old English

Cyrillic

German

Italian

The three symbol fonts contain a total of 217 symbols

Composing begins by entering the text, a line at a time, the User-Definable Keys are employed to position the lines, scale the

text, change the font, display the message on the screen or output it to the plotter. The message may also be saved on tape.

Each line may be right, left or center justified. Or a line may be moved up, down, right or left and "fixed" where desired. Each line of characters may be scaled to the desired size. You may change pen colors as each line is output to the plotter. An editing routine lets you add, change, or delete text. 

SUPER FONT

14 Fonts

217

Symbols

RGpoo/LH

✿ ~ *

✿ * ♡

Choose Your Size

Text

Placement

А В Г Д Ж З И Л П Ц Щ

Δ Γ Λ Ω Σ Φ α υ λ ψ

℞ € ℥ w x y

Peripheral Maintenance is Important Too

By Terry Davis
TEKniques Staff

In the previous issue of TEKniques, we looked at routine maintenance items that can keep the 4050 Systems looking and operating their best. In this article, we'll be looking at those routine maintenance items that can do the same for all of the peripheral equipment that combines into systems with the 4051, 4052, and 4054. The information will be presented by topics, such as Cleaning. The applicable equipment will be noted beneath the topic heading.

The maintenance operations are simple to perform, and can help to keep your system looking its best, and operating its best as well.

Table 1 establishes the maintenance steps and schedule; it's followed by specific instructions on the required maintenance items. Keep in mind that all products are designed with a wide range of environmental conditions in mind, important for maintenance and use. Equipment operating in more extreme environments may require more frequent maintenance steps. (Environmental specifications are usually found in the Specifications Sections of device Operator's Manuals.)

Cleaning Exterior Surfaces All Peripheral Equipment

CAUTION

Avoid chemical cleaning agents that might damage the plastics, paint, or metal parts. Avoid chemicals that contain benzene, toluene, xylene, acetone, or similar solvents.

WARNING

Don't clean any unit with power applied.

You can clean product exterior surfaces with a mild detergent and water solution. Dampen a soft cloth with the solution, and wring it out thoroughly before wiping the surface. Don't use too much detergent and water, as it may run into the internal parts of the system. If extensive

Table 1
Routine Maintenance Schedule*

| Maintenance Item | Interval |
|----------------------------|---|
| Clean Exterior Surfaces | 30-60 days or as needed |
| Clean Fan Dust Filter | 90-120 days, or as needed |
| Clean Tape Head | 90 days |
| Packing Mag Tapes | 10-12 uses |
| Cleaning Interior Surfaces | printers and hard copiers, each paper change. |

* This maintenance schedule is based on design, testing, and the experience of equipment users. However, cleaning is dictated by individual use and environment. Some environments may require more frequent cleaning of the filter and exterior. Other systems may require more frequent cleaning of the magnetic read/write heads. Use this schedule as a basis for a maintenance schedule, but fit it to your own application and environment.



Fig. 1. Cleaning exterior surfaces helps preserve appearance.

scratches or finish damage are present, you can order touch-up paint through your local Tektronix representative.

Cleaning the Dust Filters 4051E01 ROM Expander Only

The 4051E01 dust filter installation is shown in Fig. 2. Check the filter periodically, and clean it as needed, in order to

ensure optimum air flow for cooling. The cleaning procedure is as follows:

1. Turn OFF the power switch, and unplug the power cord from your power outlet.
2. Remove the dust filter by pulling it through the opening in the filter bracket.

3. Shake loose (or vacuum) as much dust as possible.
4. Clean the filter in a mild detergent and water solution, then rinse it and dry it thoroughly.

CAUTION

Do not clean the filter with any other spray or solution. Be sure the filter is thoroughly dry before placing it back into the filter bracket.

5. Replace the filter.
6. Plug the power cord back into your power source, and turn ON the power switch.

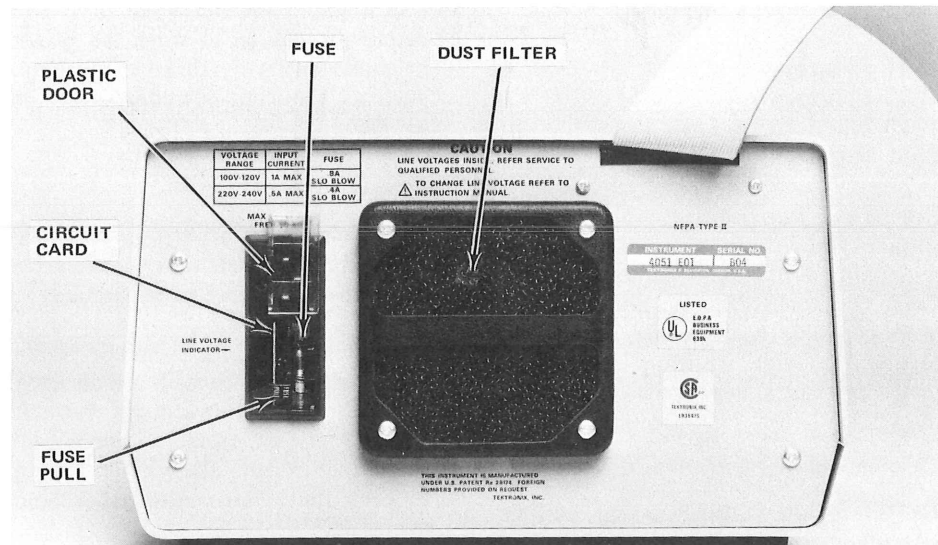

Fig. 2. The dust filter should be kept clean to ensure optimum air flow.

Cleaning Magnetic Tape Heads

4924 Tape Drive Only

It's important that tape heads be kept clean, both to prevent data errors and to preserve the life of the head. Oxide deposits, dust, and other foreign particles may be left on the head during the tape operation, and can act as abrasives. The frequency of cleaning depends on the amount of tape drive use and the cleanliness of the system environment. Use the following procedure to inspect and clean the tape head.

CAUTION

Do not use magnetic devices near the tape head. Do not touch the tape head with metal or other hard objects. Doing so may damage the head, resulting in tape cartridge damage and causing loss of data.

1. Turn OFF the 4924 power switch, and unplug the power cord from your power source.
2. Inspect the tape head by shining a small light, such as a penlight, at an angle across the head surface. Look for accumulated foreign matter or damage to the head (Fig. 3).
3. If the head is dirty, continue with this procedure. However, if the head is damaged or worn, it should be replaced by a Tektronix Field Service Specialist. (Refer to Fig. 4.)
4. To clean oxide and accumulated foreign matter off the head surface, use a cotton swab moistened with isopropyl alcohol or a alcohol-moistened head

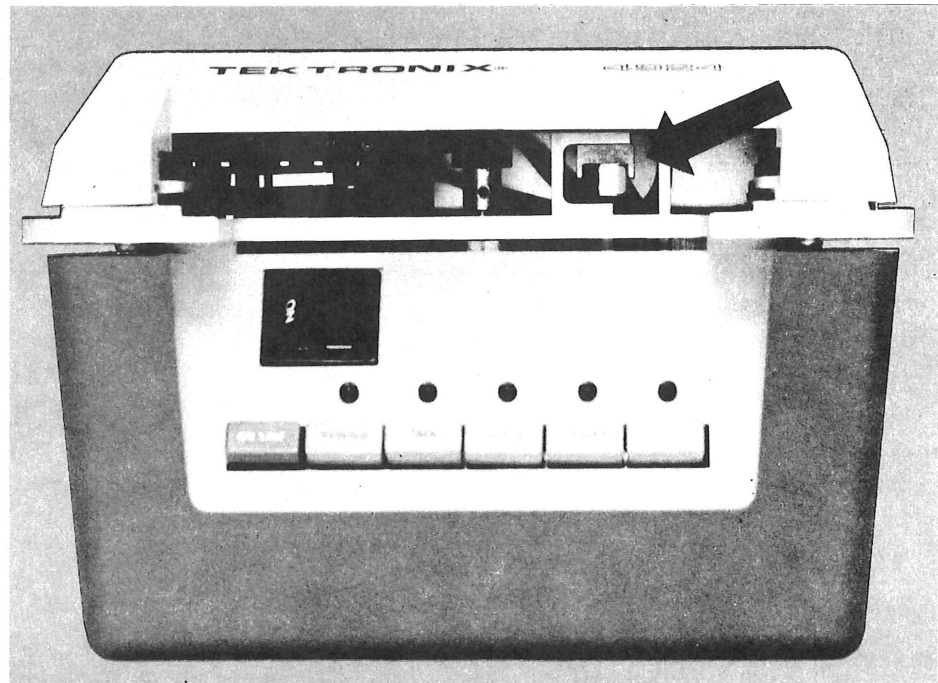

Fig. 3. Inspect tape head for wear or damage when cleaning.

cleaning pad. Light oxide accumulations are readily removable. Heavy, or long-term, accumulations may require more cleaning, with more alcohol and clean swabs. Use extreme care when cleaning the head to prevent scratching or damaging the head surface.

5. After removing all accumulated material, use a clean, dry cotton swab to remove alcohol residue and polish the head.
6. Plug the power cord back into the power source, and turn ON the power switch.

Packing Tapes

4924 Tape Drive

It's a good idea to cycle (completely wind and rewind) tapes periodically. This "packs" the tape, keeping tape tension evenly adjusted and to prevent irregular stacking. This is especially important if only a portion of the tape is used repeatedly. It is also valuable if the tape has been dropped or has undergone a significant temperature change. Use the same procedures described for the 4050 Systems in the Maintenance Article in Vol. 4 No. 8; it's not necessary to pack them in the 4924 itself.

Cleaing Interior Surfaces

4641 Printer
4642 Printer
4610 Hard Copy Unit
4631 Hard Copy Unit

For most equipment, the interior surfaces should not be accessed except by qualified technical personnel. Hard Copy Units and Printers, however, with user-accessible parts within, are subject to paper particle build-up and, in the hard copy units, deposits on the face of the crt.

Cleaning instructions are as follows:

1. Turn off the POWER switch, and disconnect the unit's power cord from the power source.
2. Open the unit's cover and secure it in the upright position.
3. Using a soft brush, or a vacuum with a soft cleaning attachment, remove all deposits of dust and paper particles. Use caution around the hard copy paper guides, as there are sharp paper-cutting edges.
4. Using a soft cloth, clean the paper guides and platen surfaces of the printers.
5. Using a cloth dampened (not soaked) with glass cleaner, remove any deposits from the face of the Hard Copy Unit crt. (Refer to Fig. 5.)
6. Close the unit's cover. Connect the power cord to the power source, and turn the POWER switch on.

Tablet and Plotter Surface Cleaning

4956 Graphics Tablet
4662 Plotter
4663 Plotter

These devices require little maintenance, except for routine cleaning of the exterior surfaces. Some special precautions apply to the actual tablet surfaces, and the plotter platen as well. Use the following procedure:

1. On Plotters, press the front panel LOAD button to move the pen to the right margin. Remove any paper present on the platen.
2. Turn the unit's Power switch off and disconnect the power cord from the power source.

3. Use a soft cloth moistened in a mild detergent solution to wash the platen or tablet surface. Abrasive cleaners, such as scouring powder, must be avoided.

CAUTION

Abrasive cleaners and strong chemical cleaners may scratch or even remove layers of the platen and tablet surfaces.

4. Remove soap residue from the platen or the tablet surface with a moistened cloth, then dry with a damp cloth. It is especially important to remove all soap residue from the plotter platen, to keep the electrostatic paper hold operating it's best.

5. Connect the power cords back to the power source, and turn the POWER switch on.

Disk Read/Write Head Cleaning

4907 File Manager

Like Magnetic Tape Heads, the Read/Write Heads in the 4907 File Manager should be routinely cleaned to prevent data errors and head damage. Disk heads should be cleaned by qualified technical personnel. Instructions are located in the Maintenance Section of the 4907 Service Manual. 

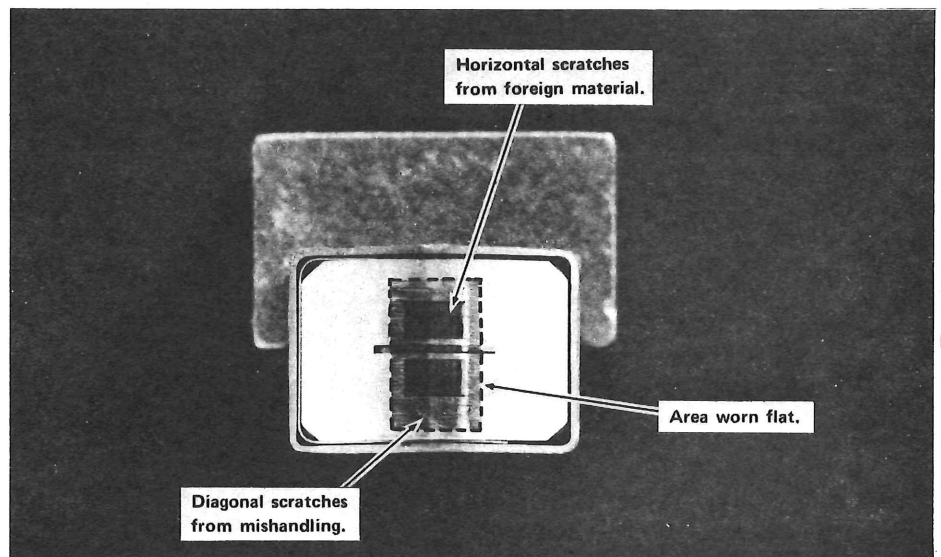

Fig. 4. Tape head damage to look for.



Fig. 5. Clean the hard copy CRT to maintain best copy quality.

4050 Series Applications Libraries

Africa, Europe, Middle East

Contact local sales office

Australia

4050 Series Applications Library
Tektronix Australia Pty. Limited
Sydney
80 Waterloo Road
North Ryde, N.S.W. 2113

Canada

4050 Series Applications Library
Tektronix Canada Ltd.
P.O. Box 6500
Barrie, Ontario
Canada L4M 4V3

Caribbean, Latin America and Far East (excl. Japan)

IDD Group
Export Marketing
Tektronix, Inc.
P.O. Box 500
Beaverton, Oregon 97077
U.S.A.

Japan

4050 Series Applications Library
Sony/Tektronix Corporation
9-31 Kitashinagawa-5
Tokyo 141 Japan

United States

4050 Series Applications Library
Tektronix, Inc.
Group 451
P.O. Box 500
Beaverton, Oregon 97077

Tektronix
COMMITTED TO EXCELLENCE
TEKTRONIX, INC.
Information Display Division
Applications Library
Group 451
P.O. Box 500
Beaverton, Oregon 97077

Address Correction Requested — Forwarding and Return Postage Guaranteed.

RICHARD ALLBERRY
58-758
IF YOU HAVE MOVED
PLEASE CALL 3618

TEKTRONIX, INC.

PAID

U.S. POSTAGE

BULK RATE