

THE 4662 DIGITAL PLOTTER

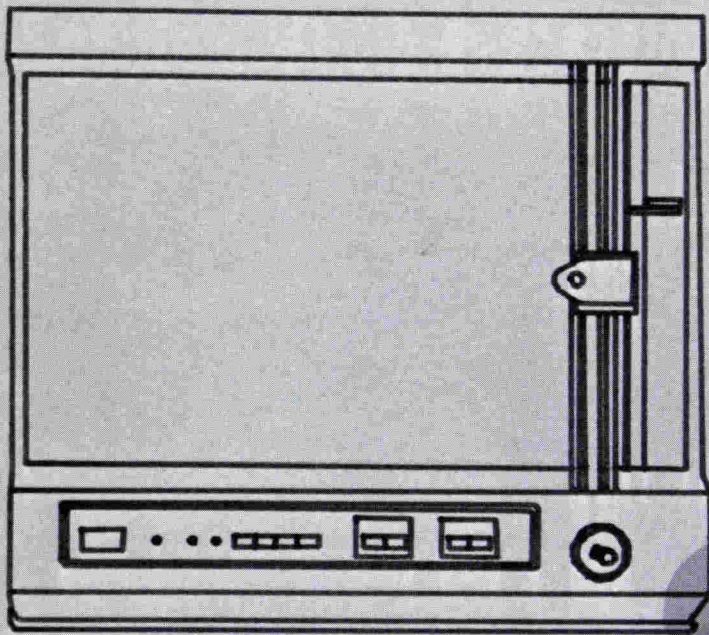

 **4662**
TEKTRONIX®

TEKSCOPE



TEKTRONIX®
committed to
technical excellence

Customer Information from Tektronix, Inc.,
Beaverton, Oregon 97077

Editor: Gordon Allison

Contents

2 **The 4662 — A new concept: Interactive digital plotting**

A new microprocessor-based digital plotter with both RS-232-C and GPIB interfaces as standard equipment provides interactive plotting, page scaling, digitizing and camera-ready output in a rugged, lightweight package.

8 **Taking the delay out of delaying sweep**

The new DM44 option brings delta (Δ) delayed sweep operation to the 400 Series Portable Oscilloscopes, plus digital multimeter functions including temperature measurements.

12 **TEK SPS BASIC — modular software for instrument control**

A new generation of instrument control software that includes new features and concepts to make instrument control and waveform processing fast and simple.

16 **Clearing up the 7623 storage picture**

A Servicescope article that will help you set the internal storage adjustments for optimum storage operation.

19 **New products**

The latest in new products and accessories available from Tektronix.

Cover: The 4662 Digital Plotter draws itself from memory, an internal buffer memory, that lets your computing device keep on working while the 4662 keeps on plotting. The 4662 is the first micro-processor-based B-sized digital plotter, and offers interactive plotting, page scaling and digitizing.

Copyright © 1976, Tektronix, Inc. All rights reserved. U.S.A. and Foreign Products of Tektronix, Inc. are covered by U.S.A. and Foreign Patents and/or Patents Pending. TEKTRONIX, TEK, SCOPE-MOBILE, TELEQUIPMENT and  are registered trademarks of Tektronix, Inc. Printed in U.S.A.

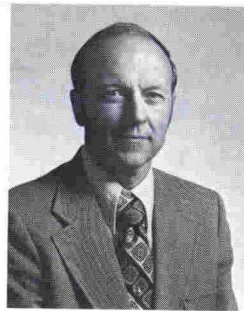

Byron Fisher

The 4662— A new concept: Interactive digital plotting

Tektronix' new 4662 is the first microprocessor-based, B-size digital plotter for interactive plotting, page scaling, digitizing, and camera-ready output.

The 4662 performs three basic types of operations. First, it can print alphanumeric characters, drawing the ASCII character received on the plotting surface. Secondly, it can produce graphics by moving the pen across the plotting surface, lifting and lowering it to produce written vectors when desired. Finally, the graphic input (GIN) operation allows the plotter to act as a digitizer, via the joystick, transmitting the coordinate position of the pen along with pen status (up or down) upon command. Actual implementation of these operations varies according to the interface being used.

The 4662 provides permanent graphic recording capabilities for any environment that has an RS-232-C interface, from minis to mainframes. The 4662 also comes standard with a GPIB interface (IEEE 488-1975 standards).

These interfaces are fundamentally different in their handling of data and in the types of commands that they decode. This results in an instrument that is functionally the same regardless of interface, but which is operationally different, depending upon the interface being used. The choice of interfaces allows the plotter to be used with a wide variety of systems and equipment, including all TEKTRONIX computer display ter-

minals, from the 4023 to the new 4051 Graphic System.

At the interface level, the 4662's operations fall into two categories. It can accept output from a computer system, or it can provide input to a host system. The following are the operations that fall into each category: (1) plotter input — accepts host output: plotter graphics, alphanumeric printing, and operating commands. (2) plotter output — provides host input: GIN (pen position and status) data, status information, size information, and block acknowledge responses.

Features users will like

Because it's a digital system, there's no servo hysteresis, no drift, and no slidewires to clean and lubricate, as in

potentiometric feedback systems. Because the plotter has a 1,600 byte buffer, the user's computing device can work on something else while the 4662 is plotting. Because it draws characters on a 15 x 7 matrix, its penmanship is excellent, even at its considerable speed — 16 to 22 inches per second (vector dependent), with a pen action rate of 10 points per second.

The 4662 has the ability to scale the alphanumeric character sizes, independent of plot size. Alphanumeric characters can also be rotated in 1-degree increments — a feature that is especially useful for producing highly professional annotated graphics. Four easily interchangeable nylon-tip pens provide the user with multi-color plotting capabilities.



When you power up, the plotter automatically adjusts for a 10 x 15-inch plot. Page size can be scaled down from there, with all graphic data plotted within the scaled-down page reflecting changes in the X-Y ratio. You get high resolution (.005-inch), excellent repeatability ($\pm .0025$ -inch), and high accuracy (.4% of vector length).

Plots can be made backward, upside down, or both — a feature that is useful for preparing negative-image plots and projection transparencies.

Paper is not a problem. Because of the 4662's electrostatic paper holddown (paper is held in position by an electrostatic field generated by the platen), you can use odd sizes and weights — just about any kind of paper you want. Sizes up to 11 inches (Y) by 17 inches (X) are accepted.

The 4662's state-of-the-art mechanical stability, combined with its exterior dimensions — width 20 $\frac{3}{8}$ inches, height 8 inches, depth 19 $\frac{1}{2}$ inches — and a weight of only 32 pounds make it highly portable.

It's also smart enough to test itself before going to work. One self test occurs when the plotter is powered up: it automatically performs internal checks on the RAM (buffers) and the ROM, in which the controlling program is stored. In addition, the pen is moved to the lower right corner to automatically locate a physical reference. The selected interface is then enabled. If an error is detected in this sequence, the plotter bell will sound.

There's another self-test feature that initiates a test sequence consisting of a predetermined plot that enables the user to examine all mechanical and electrical functions except for the interfaces. This will be a real time saver in situations where a user must determine which instrument within a system is bad.

Hardware alphanumerics

An internal character generator produces upper- and lower-case character sets for six language fonts and one special graphics symbol font.

FONT 0	#\$@[\]^_{!}	STANDARD ASCII (DEFAULT MODE)
FONT 1	£α§υδσ†ÄÖÅ	SCANDINAVIAN
FONT 2	£α§υδσ†ÄÖÜ	GERMAN
FONT 3	£α§[\]†{!}	GENERAL EUROPEAN
FONT 4	£α§iñ¿†{!}	SPANISH
FONT 5	#\$\$[\]†◀▶	SPECIAL GRAPHIC SYMBOLS
FONT 6	#\$@[\]†{!}	4051 VERSION

The hardware alphanumerics feature of the plotter allows alphanumeric text to be printed on plots without requiring character generation software support by the host system. This allows simplified production of annotated graphs on line, and manual annotation off line directly from a terminal keyboard. The ASCII charac-

ters that are accepted include the 95 ASCII printing characters plus BEL, BS, CR, FF, HT, LF, and VT control characters.

The alphanumerics feature may be modified to suit the requirements of each individual plot by the use of three modifying commands. These are "Alpha Scale" (which allows modification of both width and height of the characters), "Alpha Rotate" (which allows rotation of the printing plane), and "Alpha Font" (which allows selection of special character fonts).

Use existing software

The 4662 is compatible with the entire Tektronix family of computer display terminals. Software support is provided by the "4662 PLOT 10 Utility Routines" (standard FORTRAN subroutine package). The utility routines comprise a FORTRAN package of replacement and new subroutines for PLOT 10 TCS (Terminal Control System). TCS supplies scaling, clipping, relative addressing, dashed lines, and point plot. The new routines (for the 4662) provide for Alpha character scaling and rotation. The new/modified routines also facilitate terminal-screen previewing before dumping the graph off to the plotter.

Digitizing and scaling with the joystick

Digitizing is accomplished by sighting through a cross-hair instrument while manipulating the joystick — a positioning control located on the front panel. The joystick allows the operator to manually move the pen to any location on the plotting surface. The "CALL" key is then pressed and the pen's X-Y location is transmitted to the host terminal or computer.

By the use of the joystick and support software, the plotter has the ability to "window up" small areas of a plot to full-scale presentation (10 x 15 inches) — and, conversely, reduce large areas to the size of a postage stamp, for example, or even smaller.

Plotters in series and parallel

With the RS-232-C interface, up to four plotters can be hooked up in series and individually addressed through their own codes. The GPIB interface, on the other hand, allows the individual addressing of 15 plotters, hooked up in parallel.

Using the RS-232-C interface

The RS-232-C interface allows the plotter to be operated from a host computer transmitting data over RS-232-C communication lines. Asynchronous full-duplex transmission can occur at user-selectable data transfer rates of 110, 150, 300, 600, or 1,200 baud. All data must be transmitted in ASCII. In the POWER OFF condition, a relay connects the RS-232-C loop through connectors straight through so that you can operate the line up to 9,600 baud without disconnecting the instrument.

The RS-232-C interface has two connection ports on

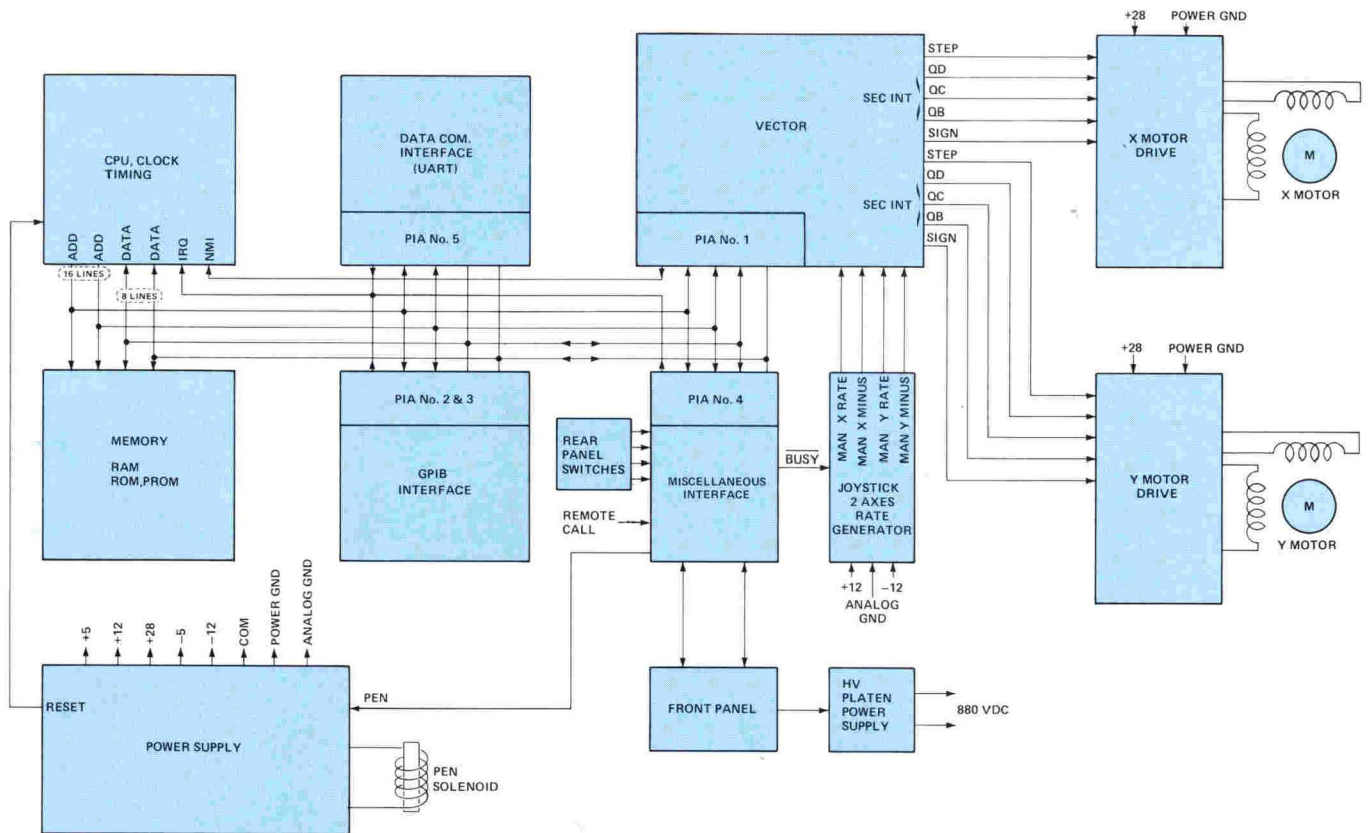

Fig. 1. Hardware block diagram for the 4662 Interactive Digital Plotter.

the rear panel, one for a terminal and one for a modem. This arrangement allows the plotter to be "chained" to other devices, such as the TEKTRONIX 4006-1 or 4010-series terminals, the 4923 Option 1 Digital Cartridge Tape Recorder, or any other device with the RS-232-C interface. This allows time-sharing program preparation and execution to be performed.

Using the GPIB interface

The General Purpose Interface Bus is an interface that allows the plotter to be used as part of an instrumentation system. The design of the interface allows three different types of devices on the bus: listeners, talkers, and controllers. The addressing capability of the General Purpose Interface Bus allows specific listeners and talkers to be activated and deactivated independently. The responsibility of the "Controller" is to designate which devices are active to listen and to talk. The controller may be the TEKTRONIX 4051 Graphic System or any other programmable controller with the GPIB-type interface.

In the GPIB system, the 4662 can be a listener — since it can accept data and commands to produce graphs and printed alphanumerics. Or it can be a talker — since it can send the current pen coordinates and status messages to the controller or to another listener device. A

controller, such as the 4051, is necessary to oversee which devices are active and when, unless the plotter is set to "Listen Only" or "Talk Only" mode.

A mind of its own

The 4662 converts information received from its interfaces into its own standardized internal commands. Almost everything is firmware driven. The GPIB interface, for instance, is implemented using two PIA's (peripheral interface adapters) and a half-dozen chips — including the line drivers. The balance of the interface resides in the firmware.

The firmware monitor (see figure 2 for firmware block diagram) is essentially an idle loop that scans around looking for things to do. When it runs out of work, it goes to the interface. If the interface has received any graphics commands during the previous time period, they're assembled into the internal format.

Each of the "boxes" around the outside of the monitor handles specific functions, responding only to internal commands. For instance, in GPIB there's a PRINT command, which is dispatched to the alpha generator. The alpha generator looks at the command and says — "Ah ha, it's an A." Then goes over to its tables and figures out the various strokes it takes to make an A . . . and dispatches them back to the monitor as *moves* and

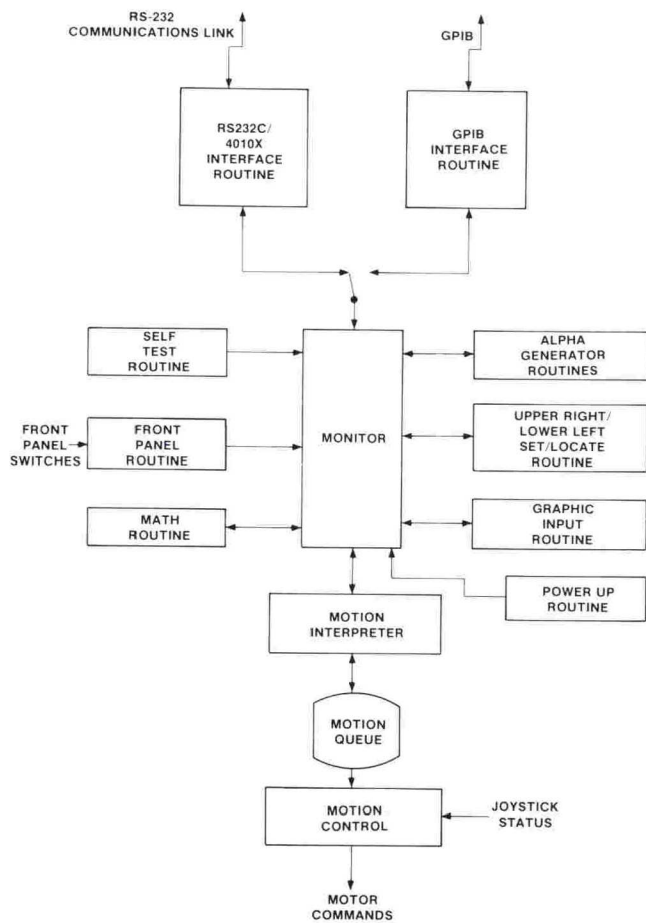

Fig. 2. Firmware command-flow diagram for the 4662 Interactive Digital Plotter.

draws, which are dispatched to the motion interpreter, which scales them to the current page size and checks them against the given limits to make sure that the drawing is not going to be made outside the physical boundaries of the machine. The motion interpreter breaks down the move/draw commands into the required format for the motion hardware, and puts it into the motion queue — which can be thought of as the “rubber band” between the internal firmware and the actual physical motion control. The motion control reaches into the queue and gets a motion command, then commands the hardware to get that motion accomplished, which takes some finite time.

While that’s going on, the monitor might be assembling other print commands. A lot of activities are going on during the time a motion is taking place. Since the motion queue holds up to five moves, the monitor can process five moves ahead of the physical motion that is taking place . . . then go off to do other things while that motion is going on. Of course this is a simplification of a complex process.

There are two levels of interrupt going on. As an absolute requirement, the plotter must keep up with the motion hardware. If a position increment were lost

every so often, eventually the pen would exceed a boundary and hit the physical stop, causing an irrecoverable loss of position. A secondary requirement is to keep up with the interface. Thus the reason for the 1,200 baud limit. When the plotter is moving fast, it has to keep up with the motion hardware, which leaves just enough time to fetch characters from the interface.

The microprocessor

The microprocessor talks to the memory system, to the interfaces, to the vector generator, and to the front panel. It’s an MC6800 system, with 2K bytes of buffer—approximately 400 being used for scratchpad memory. The remainder is used to buffer incoming and outgoing data.

The operator controls the interface parameters by four rotary hexadecimal switches located in the rear panel. These switches, which encode four bits of information, also control system functions such as the device address in the system, baud rate, format definition, terminator sequence definition, implementation of the carriage return, scaling, and plotting speed selection—either full or half. Half speed puts the rate of vector acceleration at one-fourth of what it was and the vector terminal velocity at half of what it was.

An internal timer creates an interrupt every 8 milliseconds to send the microprocessor out to look at the front and rear panel switches to detect any change. A detected change is converted into an internal command and sent to the monitor.

The vector generator

From an engineering point of view, the vector generator is one of the most interesting modules in the 4662. The microprocessor is in almost 100% control of velocity generation, while the vector generation is a hardware process employing a digital integrator to arrive at velocity information for the two axes. The host is not being used to break down the vectors into incremental information.

The microprocessor receives a coordinate point through one of the interfaces or from the front panel, subtracts the current pen position to extract ΔX and/or ΔY . The two deltas are compared and the larger axis rate is multiplied by the scaling factor $\frac{\Delta \text{small}}{\Delta \text{large}}$.

The motor drives

While the magic of vector generation lies in very tightly controlled velocity/time profiles—the secret of the motor drive lies in current balancing in the motor coils, which tends to produce the effect of a DC servo loop. The combination produces the good-looking lines.

Line aberrations are kept to a minimum by breaking down the addressable .005-inch resolution by a factor of 8 (essentially, a conventional 1.8° step is broken into

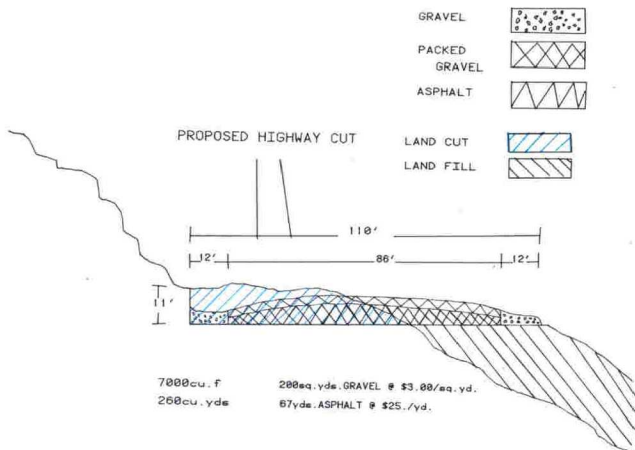

Fig. 3. A typical civil engineering application for the 4662 is shown here. Plot courtesy of RLS Associates.

16 parts). This produces a motor resolution of 625 millionths of an inch.

Three axes are involved in pen movement. The X-axis motion is controlled by a stepping-motor/pulley/cable system that is connected to the carriage, as is the Y-axis motion (which rides on the X-axis carriage). The Z axis (pen up and down) depends upon a rotary solenoid coupled through a cam/slider assembly. Because the X axis carries the combined mass of the carriage and the pen carrier, substantial dynamic mismatching of the X and Y axes results. The solution is to use a linear varying system—different size drive cables for the X and Y axes—to match time delay for a step function. In order to achieve similar loads on both X and Y motors, a high-inertia pulley is used on the Y-axis motor.

The foregoing provides a reasonable match in dynamics of the X and Y axes, which contributes, again, to the line quality of the plotter.

The joystick is essentially a voltage and frequency converter for two axes. It's nonlinear, to allow fast traverse to a point and slow precise positioning to the point. The joystick drives the motion hardware directly and simply informs the microprocessor about what it has done. The microprocessor intervenes if the user attempts to move the pen over a physical boundary.

Adjustments

Adjustments are few. Five tweaks take care of 100% of the electronic adjustments. One sets the regulator voltages, two are for joystick centering, and the remaining two take care of joystick rate symmetry.

Have Terminal, Will Travel

The low weight of the 4662—only 32 pounds—has been achieved mainly through the use of a high-efficiency power supply and the use of an aluminum chassis. This portability feature may literally change ways of doing business.

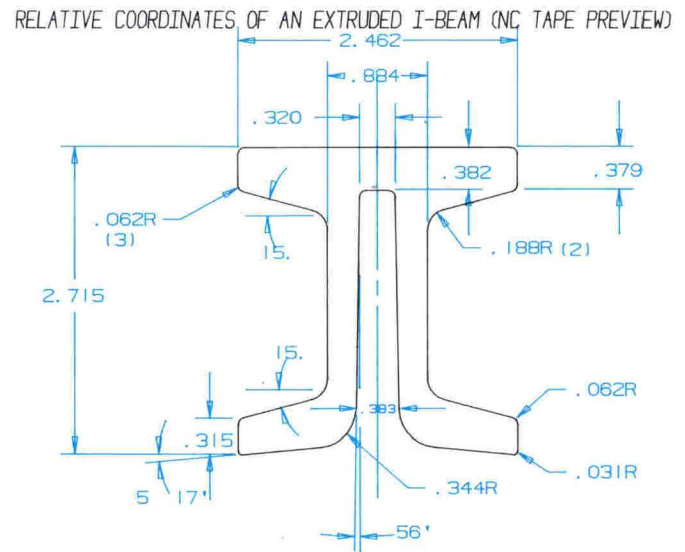

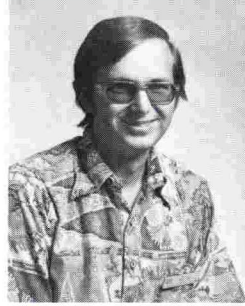

Fig. 4. The versatility of the 4662 accommodates a wide range of applications, such as the above Numerical Control Tape Preview. Plot courtesy of the ALCOA Technical Center.

For instance, one user's business is providing an N/C (numerical-control) time-sharing service. As part of that service, the firm draws a picture of the part being programmed. Now that the 4662 is available, a salesman can get on a plane and walk into a prospective client's office—anywhere—carrying the 4662 in one hand, and plug into the customer's terminal. That's selling power. 



Bill Law

Taking the delay out of delaying sweep measurements

Time is important. Especially in the world of electronics where events happen in milliseconds, microseconds, nanoseconds, and even picoseconds. An oscilloscope with delaying sweep is the most versatile tool we have for viewing such events. Delaying sweep lets you select the precise interval in time you wish to view, and then make accurate measurements in that time period.

A new option for TEKTRONIX 400 Series portables, the DM44, enhances the accuracy and ease with which these important measurements can be made. The DM44 features delta (Δ) delayed sweep operation, a new technique that uses separate controls to select the beginning and end of the interval to be measured.

In delta (Δ) delayed sweep operation the delayed sweep is caused to run at two different points in time relative to the start of the delaying sweep—once, at the beginning of the delay interval, as determined by the setting of the Delay Time Position control, and again at the end of the delay interval as selected by the Δ Time control. The times during which the delayed sweep is running are indicated by two intensified zones on the crt trace as shown in Figure 1. Although both zones appear to be occurring on the same sweep, they actually are generated on alternate sweeps. The time interval between the two intensified zones is digitally calculated and displayed on the LED readout of the DM44.

For greater accuracy in making the measurement, the oscilloscope can be operated in the B Delayed mode. This operating mode provides maximum resolution and repeatability in selecting the time interval. The beginning and end of the delay interval are displayed in greater detail and, using the Δ Time control, can be superimposed for precise setting of the delay interval (see Fig. 2). The accuracy of the displayed measurement is within 1%, ± 1 count, from +15°C to +35°C.

With the oscilloscope operating in the dual-trace mode, the time interval between a signal on Channel 1 and one on Channel 2 can be measured by setting the intensified zones to the desired point on each trace (see Fig. 3). Since both zones can be positioned anywhere on-screen, there is no need to assure the leading signal appears on Channel 1 as in some other instruments.

Some other measurements

The DM44 includes another new function, 1/TIME, for convenience in making frequency measurements. Since the reciprocal of time is frequency,

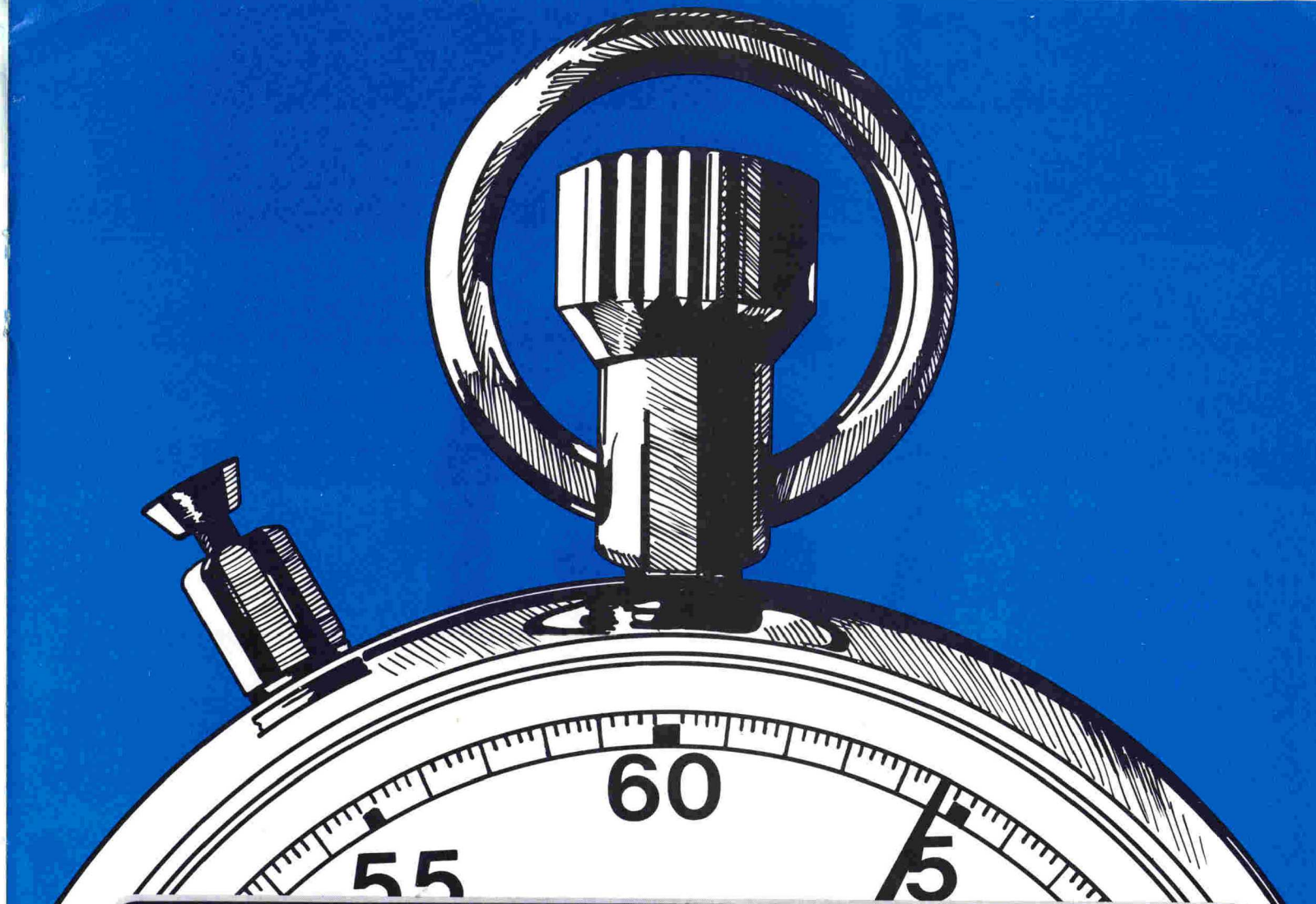

RANGE
200mV 2V 20V 200V 1.2kV
2000 2kΩ 20MΩ 200kΩ 2MΩ 20MΩ

FUNCTION
VOLTS OHMS TEMP(°C) 1 TIME TIME

TIME ΔTIME
ms 1ms μs 1μs

TEKTRONIX DM 44

0.265

465 OSCILLOSCOPE

POSITION CH 1 BR X

VOLTS/DIV VAR

1MΩ 20pF AC DC GND

20MHz BW (PULL)

TRIG VIEW VERT MODE

CH 1 CH 2

POSITION CH 2 BR X

VOLTS/DIV VAR

1MΩ 20pF AC DC GND

INVERT BEAM FINDER

DELAY TIME POSITION

COUPLING AC LF REJ HF REJ DC

SOURCE STARTS AFTER DELAY NORM CH 1 CH 2 EXT

B(DLY)/TRIGGER SLOPE LEVEL

A AND B TIME/DIV AND DELAY TIME

X10 MAG UNCAL ms μs

HORIZ DISPLAY A LOCK KNDAS MIX A INTEN B DLYO

TRIG MODE AUTO NORM LF REJ HF REJ DC

SOURCE CH 1 CH 2 LINE EXT EXT +10

A TRIG HOLD-OFF NORM INCREASE SERIAL

CALIBRATOR 50mV 50mA 1kHz

0130772

all you need to do is select the 1/TIME mode and set the intensified zones to measure the period of one cycle of the displayed signal. Accuracy of the frequency measurement is 2% or better.

In addition to time and frequency, the DM44 includes all of the measurement capability of the DM43¹, some with improved accuracy. Dc voltage measurements are made with 0.1% accuracy, resistance with up to 0.25% accuracy, and temperature over a range of -55°C to +150°C to $\pm 2^\circ\text{C}$. All of these measurements are made independently of the oscilloscope.

The technical details

One of the design objectives for the DM44 was to provide additional user functions with little increase in cost over the DM43. This was accomplished in several ways:

1. using the latest in cost-effective integrated circuits, for example, the new quad, single-supply, op amps and comparators
2. making one main digital multimeter board compatible with all instruments
3. using existing parts wherever possible, with as many parts as possible machine insertable
4. keeping the number of adjustments to a minimum, and
5. simplifying existing circuitry wherever possible.

A good example of circuit simplification is in the new temperature circuit (see Fig. 4). The circuit used in the DM43 relies on the difference in V_{BE} between two different collector currents, as a function of temperature.² The new circuit relies on the linear relationship between V_{BE} and temperature, for a constant emitter current. Fewer than half the parts are required and the circuit occupies much less real estate on the circuit board, while maintaining the same accuracy as the previous circuit.

The DM44 also features a unique approach to achieving delta delayed sweeps. Instead of using two comparators, one for each delay pickoff potentiometer, the DM44 uses one comparator, with the voltages from the pickoffs alternately applied through a FET switch (see Fig. 5).

In Channel 1, Channel 2, or Chopped operation the FET switch is activated by the alternate sync pulse occurring at the end of the delaying sweep. This means that for one delaying sweep, the voltage from the Delay Time Position control is applied to the B Sweep Comparator. During the next delaying sweep, the voltage from the Δ Time control is applied. Thus, the intensified zones are appearing on alternate sweeps although at faster sweep speeds they appear to be occurring on the same sweep.

In Alternate operation the control logic receives in-

puts from the ALT and CH 2 switches which assure that the voltage from the Delay Time Position pot is applied to the B Sweep Comparator during the time that Channel 1 is being displayed, and that from the Δ Time control is applied during Channel 2 display time. This avoids operator confusion in setting up the delay interval to be measured.

Let's back up a moment and look at the voltage pick-off circuitry (Fig. 5). The voltage from the Delay Time Position control is buffered and applied to a series resistance network paralleled by the Δ Time control. I_1 and I_2 are floating current supplies that keep the voltage range across the Δ Time control essentially the same as that across the Delay Time Position Control. As the Delay Time Position control is rotated, the voltage across the Δ Time control follows, so the voltage difference between the two controls remains the same. The effect on the display is that the two intensified zones move together as the Delay Time Position is rotated.

The voltage from the Δ Time control goes through a 2X gain amplifier. The outputs of amplifiers A1 and A2 are fed to the Time/Div switch where the proper attenuation is selected to provide a properly scaled voltage to the A-to-D converter in the DVM. The Time/Div switch also provides decimal point and scale factor (ms, μs , sec) encoding. The amplifier outputs are also fed to the FET switch that selects the input to the B Sweep Comparator.

The Δ Time control can be made independent of the Delay Time Position control by reorienting two internal jumpers. In this configuration a constant +15 V is applied across the Δ Time control and the X2 amplifier is connected as a follower. Now the two intensified zones can be positioned anywhere on-screen independently, giving the operator a choice of display modes.

400 Series compatibility

The DM44 can be ordered with any of the 400 Series Oscilloscopes with the exception of the 485. With the 465 it provides direct readout of timing measurements and a DMM on a 100 MHz portable oscilloscope. Higher frequency applications are covered by the 475 DM44 (200 MHz) and the 475A DM44 (250 MHz). Where storage is required, two 100 MHz instruments are available: the 466 DM44 with 1350 cm/ μs stored writing rate and, at reduced cost, the 464 DM44 with a writing rate of 100 cm/ μs .

Conclusion

Delaying sweep has long been an important measurement technique for many applications. Today it is being used more than ever before. The DM44 brings new operating speed and ease to these measurements, with greater confidence in accuracy of the end result.

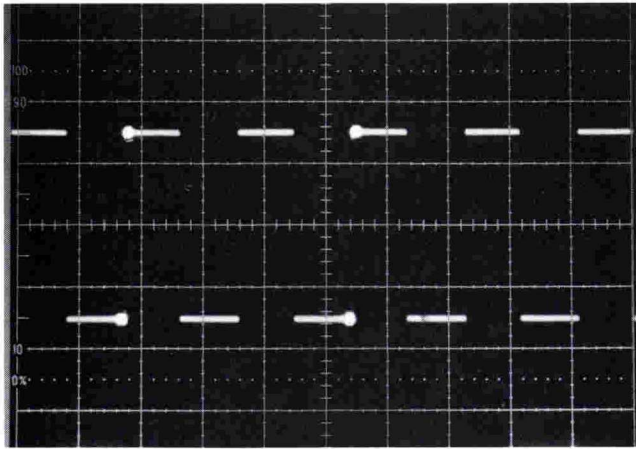

Fig. 1. The delay interval to be measured is defined by two intensified zones on the delaying sweep positioned by the Delay Time Position and Δ TIME controls. The DM44 performs the necessary calculations and displays the time interval on its $3\frac{1}{2}$ -digit LED readout.

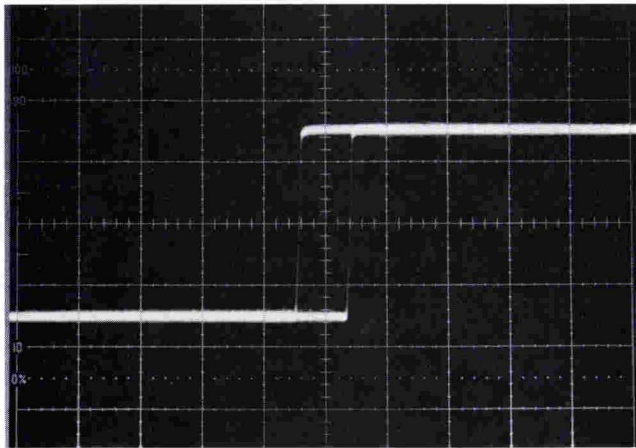

Fig. 2. Greater resolution and improved accuracy is achieved by using B Delayed mode and superimposing the beginning and end of the delay interval by means of the Δ TIME control.

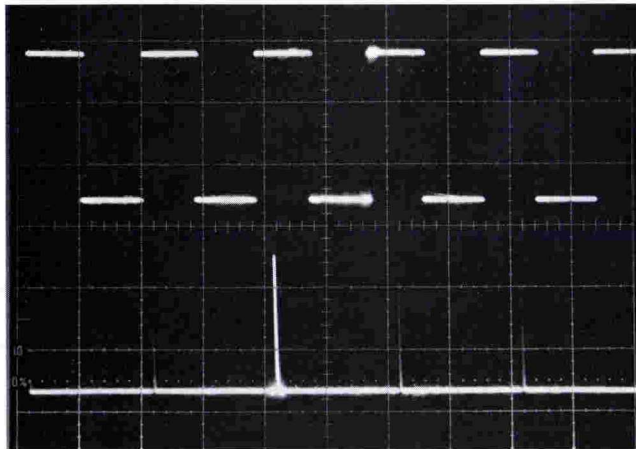

Fig. 3. The time interval between signals on Channel 1 and Channel 2 can be measured as shown here. The reference zone is always displayed on Channel 1 and the Δ Time zone on Channel 2. Either zone may be positioned anywhere on-screen to make the measurement.

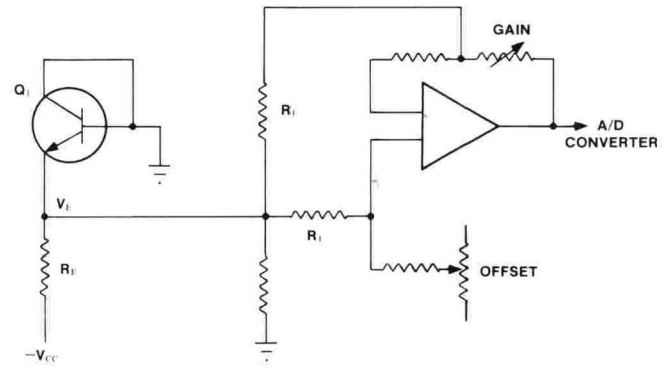

Fig. 4. The temperature circuit relies on the nearly constant slope of the V_{BE} vs. temperature curve for a constant emitter current. The sensing transistor, Q_1 has the collector-base junction grounded and a constant current in the emitter. The voltage V_E is sensed and amplified to yield a sensitivity of $10 \text{ mV}/^\circ\text{C}$. This voltage is fed to the A to D converter input. The offset and gain adjust provide initial calibration. R_1 is chosen to provide the proper amount of positive feedback to maintain a constant I_E in Q_1 .

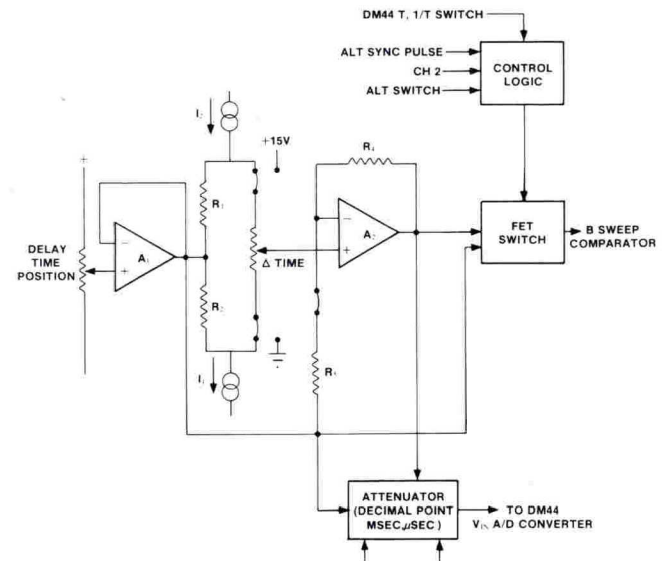
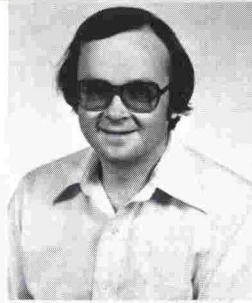

Fig. 5. Simplified block diagram of the delta (Δ) delayed sweep circuitry. The FET switch alternately applies the pickoff voltage from the Delay Time Position and Δ Time potentiometer to the B Sweep Generator. The floating current supplies permit the voltage across the Δ Time control to track the wiper voltage of the Delay Time Position control and yet maintain a full 10 cm range for the Δ Time control.

¹"The oscilloscope with the digital multimeter" Tekscope, Sept./Oct. 1974.

²"A new world of measurements for the oscilloscope" Tekscope January 1971.



Gary Fouts

TEK SPS BASIC—modular software for instrument control

A new generation of instrument control software designed to provide communication with a wide variety of data-gathering instruments and peripherals is now available for TEKTRONIX Signal Processing Systems.

BASIC was chosen for its easy-to-use structure and widespread use. Since it is an interpretive language, additions or changes to programs can easily and quickly be made at the terminal.

TEK SPS BASIC retains many of the standard features of the original Dartmouth BASIC, but includes new features and concepts to make instrument control and waveform processing fast and simple.



Modular software

A key feature in TEK SPS BASIC is modularity. Like oscilloscope plug-ins, modularity allows you to select only those features necessary for a particular job, keeping the greatest amount of computer memory free for data. Drivers (routines that communicate with instruments and peripherals), special BASIC commands, and waveform analysis packages (like Real Fast Fourier Transforms, Correlation, etc.), are loaded into memory only when needed. This ability allows you to customize your operating environment to best fit your needs.

The loading and releasing of these modules is handled with two simple BASIC statements, **LOAD** and **RELEASE**. To make it even easier for you, any non-resident command can be auto-loaded. That is, when a module is referenced in a program (or from the terminal, in immediate mode), TEK SPS BASIC automatically handles the loading of the module if it is not currently resident in memory. Execution continues uninterrupted. If room is needed later for additional modules, these auto-loaded routines are automatically released by the software. Modules brought into memory with the **LOAD** command are "locked" in, and are not released until specified in a **RELEASE** command.

Figure 1 is a block diagram of the structure of TEK SPS BASIC. The Resident portion of BASIC is the software that keeps track of your programs, loads and releases modules, and communicates with you through the system terminal.

The loadable modules are divided into three categories: instrument drivers, peripheral drivers, and non-resident commands.

The non-resident commands include several standard BASIC statements, the graphics and waveform analysis routines, and any custom routines the user may want to add. Some BASIC statements, such as **CANCEL**, **COPY**, etc., are non-resident to reduce the size of Resident BASIC.

All peripheral drivers (except the system device driver and the terminal driver, which are always resident) are modules. These include hard disk, cassette tape, line printer, floppy disk, and paper-tape drivers. More can be added at any time. Drivers for "one-of-a-kind" devices can be added to the system as needed.

No matter which peripheral you read or write to, BASIC uses the same command sequences and statements. A program including hundreds of reads and writes to peripheral units can, with one statement change, talk to any other peripheral device, including the system terminal.

The instrument drivers are the heart of any data gathering system. TEK SPS BASIC communicates with all instruments using a standard set of commands, most notably the **GET** and **PUT** statements. These two state-

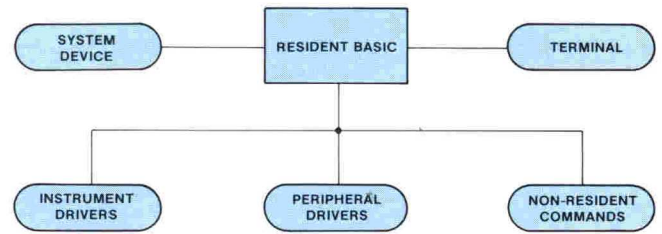

Fig. 1. Block diagram of TEK SPS BASIC structure. Resident BASIC, including the system device and terminal drivers, is the only software permanently resident in the computer. Everything else is modularized, reserving the maximum amount of memory for programs and data. The loadable modules are divided into three categories. Instrument drivers communicate with data gathering equipment either directly or through a General Purpose Interface Bus. The peripheral drivers handle such devices as disks, papertape, and line printers. The non-resident commands include both standard BASIC commands and special modules for routines such as Fourier transforms, graphics, and user-written routings.

ments are used to get data from an instrument, or to send data or instructions to the device.

Drivers for any instrument, from programmable oscilloscopes to digital voltmeters, can be written and added to TEK SPS BASIC at any time. Drivers can take on different levels of responsibility too. They can be simple relay routines, which transfer data between BASIC and an instrument. Or, they can be complex beasts capable of handling instrument interrupts and data on their own, with little or no supervision from a BASIC program. With SPS, the choice is yours.

Putting priority on your programs

Another feature which makes TEK SPS BASIC so versatile is the scheduling concept. Under software control, subroutines which handle instrument interrupts can be set up before the event occurs and executed on a priority basis as the data is acquired.

In a BASIC program, or from the terminal in immediate mode, you can assign subroutines and levels of "software priority" to tasks associated with different instruments. (Some instruments, such as the Digital Processing Oscilloscope, can have tasks assigned to each different interrupt generated by the instrument.) These associations are made with one BASIC statement, the **WHEN** command. This command tells the software what line number to go to when a certain interrupt (such as a sweep complete or a button being pushed) occurs, and what priority to assign to the task. When the interrupt occurs, the task is scheduled. Execution of the subroutine doesn't occur, however, until all routines with a higher priority level have been serviced.

Priority levels allow you to sequence data processing routines in order from most important to least important. There are 127 levels of software priority you can assign to your data gathering routines. If an interrupt occurs and the program currently executing has a priority level less than the level assigned to the interrupt

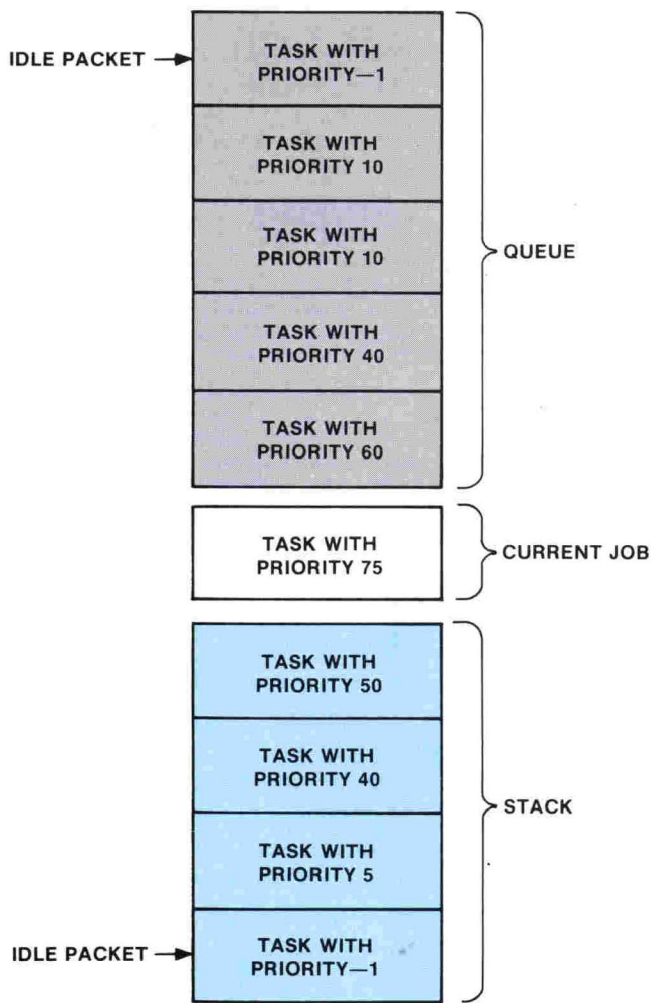

Fig. 2. Scheduler Process. The figure illustrates the structure of the Queue and Stack in the Scheduler. The Queue contains information about tasks (collections of one or more BASIC statements that constitute a subroutine) which are ready to execute, but have not done so yet because other tasks with higher priorities are also ready. The Stack contains tasks which were executing, but have been set aside because of another, higher priority task. The Current Job is the task with the highest priority.

In the example set-up shown, the task with priority 60 will execute when the Current Job is complete. Next, the tasks in the Stack with priorities of 50 and 40 execute, followed by those in the Queue with priorities of 10. Finally, the stacked task with priority 5 executes. The idle packets with a -1 priority become the Current Job when there are not other tasks to execute. The priority of -1 is used to assure that any other task, as it becomes ready, is higher than the idle state of the software.

in the WHEN command, the current program is "stacked" and the new, higher priority program begins execution. When this program finishes, BASIC unstacks the first program and resumes its execution.

The Scheduler controls the flow of commands and tasks in TEK SPS BASIC. It keeps track of all tasks which are ready to be executed, and determines which task should be executed at any time.

The Scheduler has three structures to help in its housekeeping duties: the Queue, the Current Job, and the Stack. The Queue is a list of all tasks scheduled

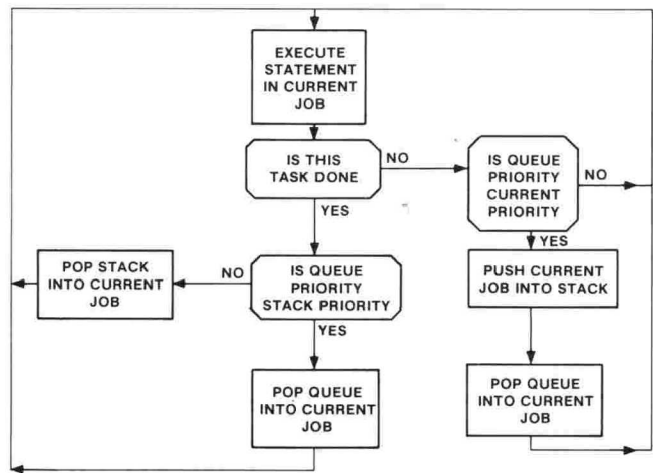

Fig. 3. Scheduler flow chart. Here's how the SPS Scheduler keeps track of its priorities. After each BASIC statement is executed, the Scheduler checks to see if the task is complete. If not, it then checks to see if a task with a higher priority task is waiting, the Scheduler stacks the Current Job, and begins executing the new task. The Current Job is always the task with the highest priority. When the Current Job is completed, the Scheduler looks to see if any tasks have been stacked, and compares that task's priority with the priority of the task in Queue. The task with the higher priority becomes the Current Job. If either the Stack or the Queue is empty, the idle packets are compared. The idle packet causes BASIC to loop, waiting for another task to become ready for execution.

(i.e., the associated instrument has interrupted) but not yet being executed because of higher priority tasks. Tasks in the Queue are arranged in priority order so that the highest priority task is the first available.

The Current Job is the task that is currently executing. When no program is actually running, an "idle task" is the Current Job. It simply loops, waiting for a task with a higher priority to become ready.

The Stack is a list of tasks which have been partially processed. A task enters the Stack when a task of higher priority requires execution before the current task is complete. Figure 2 illustrates this stacking process.

Figure 3 is a flow chart of the Scheduler process. Note that after the completion of every BASIC statement, the software checks to see if there is a task pending with a higher priority than the Current Job. Thus, the maximum time delay between interrupt and program response is the time it takes to execute a single BASIC statement. Even faster response time is possible at the driver level. Here, the time delay between interrupt and computer response is only a few microseconds. Customized instrument drivers can be programmed to handle interrupts in any manner desired.

Getting the answers out

Acquiring and processing data from digital and analog instruments are only half of the requirements of a good signal processing system. The ability to generate comprehensive and readable reports is of equal value. TEK SPS BASIC gives you several powerful tools to make your data understandable.

Graphics can make any string of numbers mean something at a glance. The DISPLAY statement in TEK SPS BASIC takes an array of numbers and draws them on the terminal screen, left to right. The value of each number determines the height of the line for any point in the display. If each element in the array represents a voltage level and each subscript a time interval, then the resultant graph is a picture of a waveform. When more than one waveform is displayed at a time, each can be identified by unique symbols interspersed in the line.

To add clarity to a waveform, the GRAPH statement is used. With one simple statement, the selected waveform can be drawn and a graticule (complete with tic marks and scaling information) automatically added. You can specify different kinds of graticules and different scaling methods, all from a BASIC program.

If you want to draw your own charts, pictures, or graphs, a wide variety of move and draw commands are available. You can move or draw to absolute screen coordinates, or to coordinates relative to the current position of the writing beam.

A user coordinate system, specified by the WINDOW command, allows you to plot your data without having to map it into screen coordinates. You can also specify a VIEWPORT, or an area on the screen where you want to draw the data. This allows many graphs (or pictures) to be drawn on the screen, each in a different location.

Graphic data can also be sent to files, stored on peripheral devices. With textual material and numeric information interspersed, these files can provide a permanent record of an experiment or test. The files can later be sent to the terminal where you can study them or make copies on paper.

Character manipulation is also important in report generation. TEK SPS BASIC includes a complete assortment of string functions. String processing not only gives you complete control of output formatting, but also allows you to use "free for" input, where your program determines what kind of data it is reading and acts accordingly.

File names can be entered into a program easily, and the program itself can create file names when an undetermined number of files must be made during execution.

Problem solving power

Problems often encountered in signal processing include keeping track of scale factors and units representing time and amplitude. TEK SPS BASIC includes a new form of array, the waveform. A waveform consists of four components: a numeric array, a data sampling interval value (time between consecutive array elements) and vertical and horizontal units, the last two expressed as strings of characters. The two character

strings describe amplitude units (such as VOLTS) and time frame units (SECONDS, for example).

A waveform is associated with these four components with the WAVEFORM statement. This statement attaches a variable name to the waveform. Whenever this name is used in computation or output, all the associated components are affected. Of course, each individual element can be accessed independently.

In all arrays and waveforms, each element is a full two-word, 32-bit, floating-point value (24-bit mantissa and 8-bit exponent). Integer arrays can also be specified. These integer arrays reserve one 16-bit word for each element, cutting required storage space in half. Array dynamic range problems are non-existent in SPS, since each array element is complete in itself.

The math package is new and completely characterized. Decimal accuracy extends to better than seven significant digits, with a decimal exponent range of ± 38 . TEK SPS BASIC automatically utilizes floating point hardware, when available, to decrease processing time. A complete set of math and trig functions is standard in Resident BASIC.

Array and waveform functions are also utilized. With one BASIC statement, you can find the minimum, mean, maximum, or RMS values of an array. A special CRS function finds a specified crossing point in an array or waveform.

Arrays are used like simple variables in BASIC expressions. As a result, FOR loops or other repetitive processes are not necessary when evaluating arrays. An "auto-dimensioning" feature allows you to input waveforms from peripherals or instruments without knowing the exact length of the data. The SIZ function computes the length of the array or waveform for you.

Array zoning is another new feature. This technique allows you to segment large arrays into smaller sub-arrays. Zoned arrays are used in computation and output in the same manner as complete arrays. This feature is especially useful in waveform processing, where only a portion of the array may be of interest. With zoning, this section can easily be extracted from the rest of the array and operated on independently.

Sizing it up

TEK SPS BASIC operates with any CP1100 Series Controller or PDP-11 Computer. Because only Resident BASIC is in memory at all times, the complete power of SPS can be realized in computers which would otherwise be too small. Segmenting programs with the OVERLAY capability further reduces the amount of memory necessary to run large and complex programs.



Clearing up the 7623 storage picture

Storage oscilloscopes are a lot like automobiles. They perform best when properly tuned up or adjusted. And while every mechanic has his own technique, there is usually one that works best for a given piece of equipment. We'd like to share with you the procedure we've found to be best for setting up the 7623 oscilloscope storage controls.

The test equipment you will need includes a test oscilloscope such as the TEKTRONIX 465 with both 10X and 100X probes, a dc voltmeter, and low-frequency and medium frequency signal generators. The TM500 Series make an ideal test package. For example, a TM503 with a DM502 and FG502 will cover the dc voltage measurements and signal generation needed to check the storage circuits. Other TM500 modules are available for complete calibration of the 7623.

Preset the 7623 controls as follows:

7623

STORAGE MODE	NON STORE	TRIGGER SOURCE	LEFT
SAVE	OFF	INTENSITY	MAX (without blooming)
AUTO ERASE	OFF	FOCUS	BEST PRE-SENTATION
READOUT	OFF		
VERTICAL MODE	LEFT		

TIME BASE

TRIGGER MODE	AUTO	TIME/DIV	0.2 ms
COUPLING	AC	DISPLAY MODE	TIME BASE
SOURCE	INT	MAGNIFIER	X1

VERTICAL (in left plug-in hole)

COUPLING	DC	NORM/INVERT	NORM
----------	----	-------------	------

SIGNAL GENERATOR

FREQUENCY	1.5 kHz
-----------	---------

Since the storage function usually begins with erasing the screen, let's check that operation first. Apply a 1.5 kHz sine wave signal to the vertical input of the 7623 and set the displayed signal to 6.4 cm amplitude. Now put the 7623 storage mode in BI-STABLE and the sweep mode in Single Sweep. With the 10X probe on your test scope, set the vertical sensitivity for 50 V/div at the probe tip, dc coupled, and the sweep at 100 ms/div. The trace on the test scope should be positioned 3 divisions below the center graticule line. Apply the test probe to the BI-STABLE Mesh Test Point and view the waveform produced when the ERASE button on the 7623 is pressed. It should appear as in Figure 1. The erase pulse should be about +320 V in amplitude and \approx 150 ms in duration. The negative going edge of the pulse should fall to or below ground and recover to the bistable operating level in 375 ms or less.

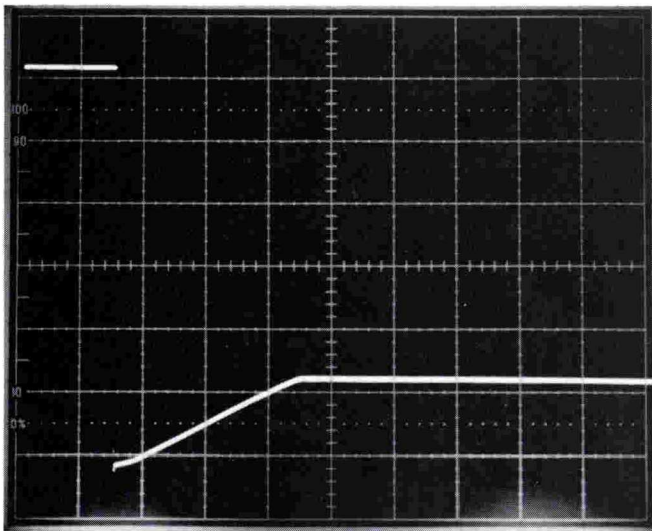

Fig. 1. Typical erase pulse as viewed at the BI-STABLE Mesh Test Point. Vertical deflection factor is 50V/div and time base is 100 ms/div.

Bistable operating level adjustment

Now let's check the bistable operating level adjustment. Remove the scope probe from the Bistable Mesh Test Point, apply the DVM to the same point, and note the reading; it should be between +50 and +80 V. Press the ERASE button and the single sweep reset button on the 7623 to store a new display. Adjust R1325 slightly in the negative direction (storing a new display after each adjustment of R1325) until the trace starts to fade after about 15 seconds. Record the voltage reading. This is the lower writing threshold. Now repeat the procedure, adjusting R1325 in the positive direction, until the screen starts to fade positive after about 15 seconds. Record the voltage reading. This is the upper writing threshold. Now set R1325 halfway between these two voltages and store a new display. Check to see that the display does not start fading positive for at least a minute. You can now disconnect the DVM.

This is a convenient time to check the AUTO ERASE and SAVE modes so place the time base in the 7623 to the AUTO trigger mode and depress the AUTO ERASE button. The display time should be selectable over a range of at least 1 to 15 seconds as determined by the VIEW TIME setting. Press the SAVE button and see that it stops the auto erase function. AUTO erase should resume when you come out of the SAVE mode.

FAST store and transfer pulse check

Next let's check to see that when operating in the FAST storage mode the transfer pulse appears on the Bistable Mesh.

Turn the intensity down on the 7623.

AUTO ERASE	OFF
MULTI-TRACE	OFF
FAST	ON

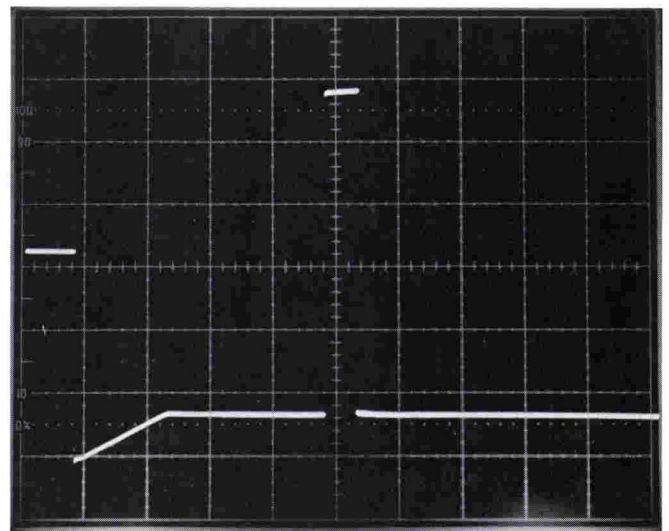

Fig. 2. Typical erase and transfer pulses. Vertical deflection factor is 100V/div and time base is 200 ms/div.

Remainder of controls as they were.

Apply the test scope to the Bistable Mesh Test Point using the 100X probe; vertical sensitivity should be 100 V/div at the probe tip and the sweep at 0.2 s/div.

Press the ERASE button on the 7623 and you should see a waveform on your test scope, similar to that in Figure 2. The erase pulse appears at the start of the sweep and the second pulse, occurring about 800 ms later, is the transfer pulse. It should be about +520 V in amplitude and 100 ms in duration.

At this point it would be well to see that the High-Speed Mesh is receiving the proper signals to capture the fast signal for transferring to the Bistable Mesh. Connect the 10X probe to the test scope and set the vertical sensitivity to 20 V/div at the probe tip and the sweep to 1 μ s/div. Apply the probe to the High-Speed Mesh Test Point. Set the 7623 time base trigger to Single Sweep and press the ERASE button. The 7623 sweep should be waiting for a trigger, and the high speed prep pulses should be running at a continuing rate. These pulses should be about 110 V in amplitude at a repetition rate of about 100 Hz. The pulse width (at the top of the pulse) should be accurately set to 2 μ s by adjusting R1559. To check rep rate, set your test scope to 5 ms/div; you should see 5 prep pulses in something more than 6.8 div. but less than 9.2 div.

Variable persistence adjustments

Now let's check the variable persistence adjustments.

Set the 7623 controls as follows:

STORAGE MODE	NON-STORE
PERSISTENCE	CCW IN DETENT POSITION
TRIGGER	AUTO
TIME/DIV	20 μ s

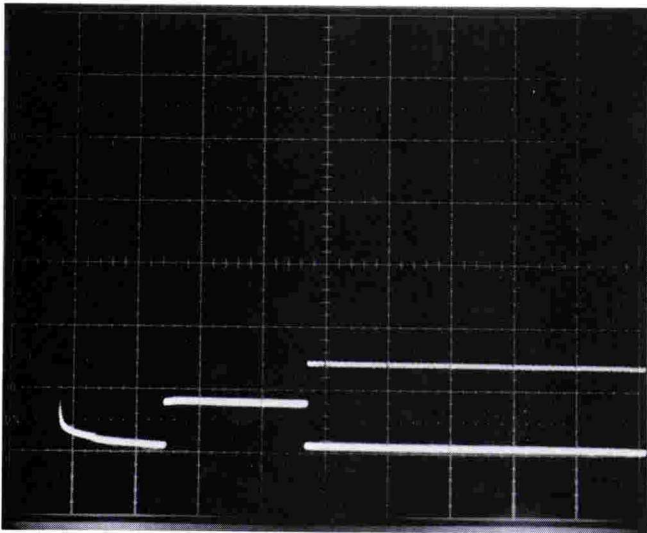

Fig. 3. Proper setting of variable persistence pulse amplitude in relation to prep pulse is shown in this photo. Vertical deflection factor is 5V/div and time base is 200 ms/div.

Turn up the Intensity and apply a 25 kHz signal, 6.4 div in amplitude. Adjust the 7623 for a steady well-defined display. Now set the 7623 as follows:

STORAGE MODE	<i>VARIABLE PERSISTENCE</i>
STORAGE LEVEL	<i>FULL CW</i>
TRIGGER	<i>SINGLE SWEEP EXT</i>
INTENSITY	<i>3 O'CLOCK</i>

Turn R1350 (VP OP LEVEL) and R1360 (VP PRED) fully cw and then adjust R1350 ccw until the 7623 screen is fully written. Then adjust R1360 ccw while repeatedly erasing, until a portion of the screen comes up dark.

After these adjustments are made, check to see that the screen can be made completely dark by turning the front-panel STORAGE LEVEL control fully ccw. Switch the trigger source to INTERNAL and press the ERASE and Single Sweep button storing the 25 kHz, 6.4 cm signal. Check to see that the center 6 by 8 div portion of the display is stored for at least 15 seconds. You may have to turn the STORAGE LEVEL control partially cw to store the image across full screen.

Next, let's set our test scope to 5V/div at the probe tip, the sweep range to 200 ms/div, and apply the probe to the Bistable Mesh Test Point. The 7623 controls should be set as follows:

VIEW TIME	<i>FULLY CW</i>
STORAGE LEVEL	<i>FULLY CW</i>
TRIGGER	<i>AUTO, INT</i>
TIME/DIV	<i>.1 s</i>

The waveform on your test scope should appear as in Figure 3. Adjust the Variable Persistence Pulse Amplitude control R1334 to set the Variable Persistence Pulse level to 3 V above the VP Prep level. (In previous procedures this pulse was set to 22 V.) Check to see that persistence increases as the VIEW TIME control is rotated ccw.

Variable persistence FAST stability

Now let's check the FAST stability adjustment. Set the 7623 storage mode to FAST, the sweep to .1 μ s/div, and triggering to Single Sweep. Apply a 2.5 MHz signal and set it for a display amplitude of 6.4 divisions. Repeatedly erase and arm the sweep while adjusting the front-panel STORAGE LEVEL control for the best display. Take particular note of the quality of the display. Erase the display and wait one minute, then arm the sweep and press the Single Sweep button generating a single sweep. Again note the quality of the display. If it is the same as before, stability is set up satisfactorily.

Now set the 7623 trigger source to EXT and press ERASE. You should have a half-bright screen ready to store. If the screen displays uneven brightness, adjust R1470 and R1480 for uniform brightness. Switch the 7623 trigger source to INT and store a single trace. Observe the display for one minute, if the display fades up increase R1393 (HS Prep) level slightly and store a fresh trace. If parts of the waveform do not store decrease R1393 and check again. Should you run out of range on R1393, Collector adjust R1439 can be adjusted slightly to extend the range. The screen should be erased and a fresh trace stored after each adjustment.

Next, switch the 7623 trigger mode to AUTO, set the STORAGE LEVEL control cw, INTENSITY ccw, and press the ERASE button. About one-third of the screen should display "splatter-up." Adjust R1410, erasing the display after each adjustment, until the desired amount of splatter up occurs.

Now set the 7623 to FAST, the time base to .1 μ s/div, and apply a 6.4 cm, 5 MHz signal to the vertical. Check to see that the center 4 by 5 divisions of the display are properly stored.

Change the 7623 trigger to Single Sweep, INT, and repeatedly erase the display and arm the time base while adjusting the front panel STORAGE LEVEL for the best presentation. Note the quality of the display. Erase the display, wait one minute, and store another trace. Again note the quality of the display for one minute. If the display starts to fade up, increase High Speed Prep level R1593 and recheck the display. If parts of the display do not store, lower R1593 and recheck the display. If you run out of range on R1593 before achieving a stable display, you can extend the range by adjusting R1439 slightly in the appropriate direction. The STORAGE LEVEL setting should be checked after each adjustment, for the best display.

This completes the storage calibration procedure. Please note that this is only a portion of the calibration procedure for the 7623. The remainder can be performed as described in the 7623 instruction manual. 

Customer training classes

Commencing with this issue, Tekscope will include a schedule of maintenance classes to be conducted during the next three months. Classes are conducted at Tektronix, Inc., Beaverton, Oregon. There is no fee for these classes except as noted.

465, 475	Sept. 13-17, 1976 Nov. 29-Dec. 3, 1976
5103N, 5A18N, 5BI2N	Sept. 27-Oct. 1, 1976
7633, 7A18, 7B53A	Oct. 25-29, 1976
7704A, 7A26, 7B70, 7B71	Oct. 18-22, 1976
*R7912, 1350, DDC	Nov. 1-5, 1976
4010, 4012, 4013, 4014, 4015, 4610, 4631, 4623	Oct. 11-15, 1976

*Fee charged for this course

Contact your local Tektronix Field Office for registration information.

New Products New Products New Products

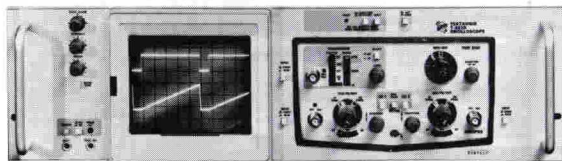

15-MHz Rackmount Oscilloscope

The T922R 15-MHz rackmount oscilloscope is the newest member of the TEKTRONIX T900 Series. Only 5¼-inches high and 17 inches deep, the T922R mounts in the standard 19 inch relay rack; it is designed for the more rugged applications rackmounts are often subject to.

The T922R basically has the same specifications as the T922. Vertical sensitivity is 2 mV/div at full bandwidth. And the crt with 12 kV accelerating potential provides a big (8 x 10 cm), bright display even in high ambient light environments.

Switchable inputs on the front and rear panels provide for instant mode change from a general purpose test instrument to a monitoring oscilloscope. Greater than 80 dB of isolation guards signal integrity.

Rackmount operating convenience is enhanced by rear panel inputs and outputs: external trigger input,

z-axis input, gate out, sweep out, and vertical signal out. The outputs can be used to drive external recorders or other instrumentation. The low cost C-5A Camera is an ideal companion for the T922R with photography enhanced by single sweep operation and graticule illumination.

For additional details on the T922R, check the appropriate box on the inquiry card accompanying Tekscope.



High Resolution Display Monitors

The 606 and 607 Display Monitors are high-resolution monitors designed for use by OEMs who make medical diagnostic equipment, analytical instrumentation, electronic counter-measures equipment, and various types of electronic instrumentation where an X-Y monitor is needed.

The 606, a non-store monitor, produces a very small dot size—6.0 mil at normal intensity and 5.0 mil at low intensity—which is uniform across an 8 x 10 cm crt. Electronic focus correction provides optimum focus over a 7 x 9 cm crt area. Spot size remains very small even at maximum intensity.

The 606 has a bright display which is particularly good for viewing. It has a monoaccelerator crt without a deflection expansion mesh and its inherent halo problems. High resolution and uniform brightness make it an excellent choice for photographic work.

The 606 has a 3 MHz bandwidth along the X and Y axes, and 10 MHz along the Z axis. Differential inputs and several other features are standard.

The 607 Display Monitor is a high-resolution monitor with variable persistence storage featuring excellent gray scale capability, good spot size at 20 mils stored, 12 mils non-stored, and an image that persists up to 50 minutes—with considerably less deterioration than you'd find in comparable units.

The 607 has a writing speed of 0.9 cm/μs; its bandwidth along the X and Y axes is 3 MHz, and 5 MHz along the Z axis. Differential inputs, remote programming and several other features are standard.

Both the 606 and 607 can be ordered as a rackmount in several configurations.



250-MHz Portable Oscilloscope

The 475A Portable Oscilloscope combines 250 MHz bandwidth with a sensitivity of 5 mV/div to provide an excellent gain-bandwidth product. It is important to note that the 250 MHz bandwidth is specified *at the probe tip*.

Sweep rate to 1 ns/div assures detailed views of fast transition times. A full 8 x 10 cm crt provides clear, easily viewed waveform displays. And, like other high performance TEKTRONIX Portables, the 475A's value is enhanced by variable trigger holdoff, trigger view, automatic scale factor readout, and availability of clip-on battery power.

The 475A also offers (as an option) direct numerical readout of displayed time intervals and a precision built-in DMM. Compared with conventional differential time measurements, the 475A DM44's direct readout approach makes measurements faster while improving accuracy and eliminating sources of human error. With the built-in DMM, the 475A becomes a more complete portable instrument for measurements at remote sites. See the attached inquiry card accompanying Tekscope for price of the 475A and to request further information.



Low-cost 10-MHz Dual Trace Oscilloscope

The D61a dual-trace oscilloscope featuring 10 MHz bandwidth, is well suited for a wide range of applications. Fully transistorized, it weighs only 15 lbs., and is

very easy to carry, view, and use. Operation is simplified by automatic selection of chopped and alternate modes and fully automatic triggering. In the tv trigger position, it automatically selects line or frame displays and with external X capabilities, can be used in the X-Y mode.

Vertical sensitivity is 10 mV/div at full bandwidth, and the large 8 x 10 cm crt provides high-contrast displays. Knobs on the front panel are conveniently located and easy to manipulate.

The D61a is an excellent choice for a student's workbench in basic physics, electronics, and electricity classes. Its characteristics make it suitable for industrial electronic applications where electronic components, circuits, or equipment must be tested. This oscilloscope is also an excellent choice for aligning and troubleshooting color television sets. In a vector display mode, it can check phase relationships of color signals when used in conjunction with a gated rainbow generator.

New Modular Probes

The P6101, P6105, and P6108 are new miniature, general-purpose probes that feature modular construction. Each probe consists of three modules: head, cable, and connector/compensation boxes, that snap together without the use of tools or a soldering iron. This makes maintenance and repair inexpensive, fast, and easy. Spare modules can be stocked for immediate replacement.

The new probes are used with oscilloscopes of up to 100-MHz bandwidth to acquire high-fidelity signals from low source-impedance circuitry.

The P6101 is a 1X, 1-M Ω probe, and the P6105 and P6108 are 10X, 10-M Ω probes. Each is available in one, two, and three meter lengths.

Additional features of the P6105 are readout and ground level reference. With an oscilloscope that has vertical scale or crt readout, this probe will automatically scale the readout by a factor of 10, making mental calculations unnecessary. Ground level can be determined on the crt display by actuating a button on the probe head.

The standard accessories for each probe are interchangeable and can be used with all three modular probes.