

INSTRUCTION MANUAL

TYPE 564
OSCILLOSCOPE

Tektronix, Inc.

S.W. Millikan Way ● P. O. Box 500 ● Beaverton, Oregon ● Phone MI 4-0161 ● Cables: Tektronix
070-351

964



WARRANTY

All Tektronix instruments are warranted against defective materials and workmanship for one year. Tektronix transformers, manufactured in our own plant, are warranted for the life of the instrument.

Any questions with respect to the warranty mentioned above should be taken up with your Tektronix Field Engineer.

Tektronix repair and replacement-part service is geared directly to the field, therefore all requests for repairs and replacement parts should be directed to the Tektronix Field Office or Representative in your area. This procedure will assure you the fastest possible service. Please include the instrument Type and Serial number with all requests for parts or service.

Specifications and price change privileges reserved.

Copyright © 1963, new material copyright 1964 by Tektronix, Inc., Beaverton, Oregon. Printed in the United States of America. All rights reserved. Contents of this publication may not be reproduced in any form without permission of the copyright owner.



CONTENTS

Warranty

- Section 1 Characteristics
- Section 2 Operating Instructions
- Section 3 Circuit Description
- Section 4 Maintenance
- Section 5 Calibration
- Section 6 Parts List and Diagrams

A list of abbreviations and symbols used in this manual will be found on page 6-1. Change information, if any, is located at the rear of the manual.

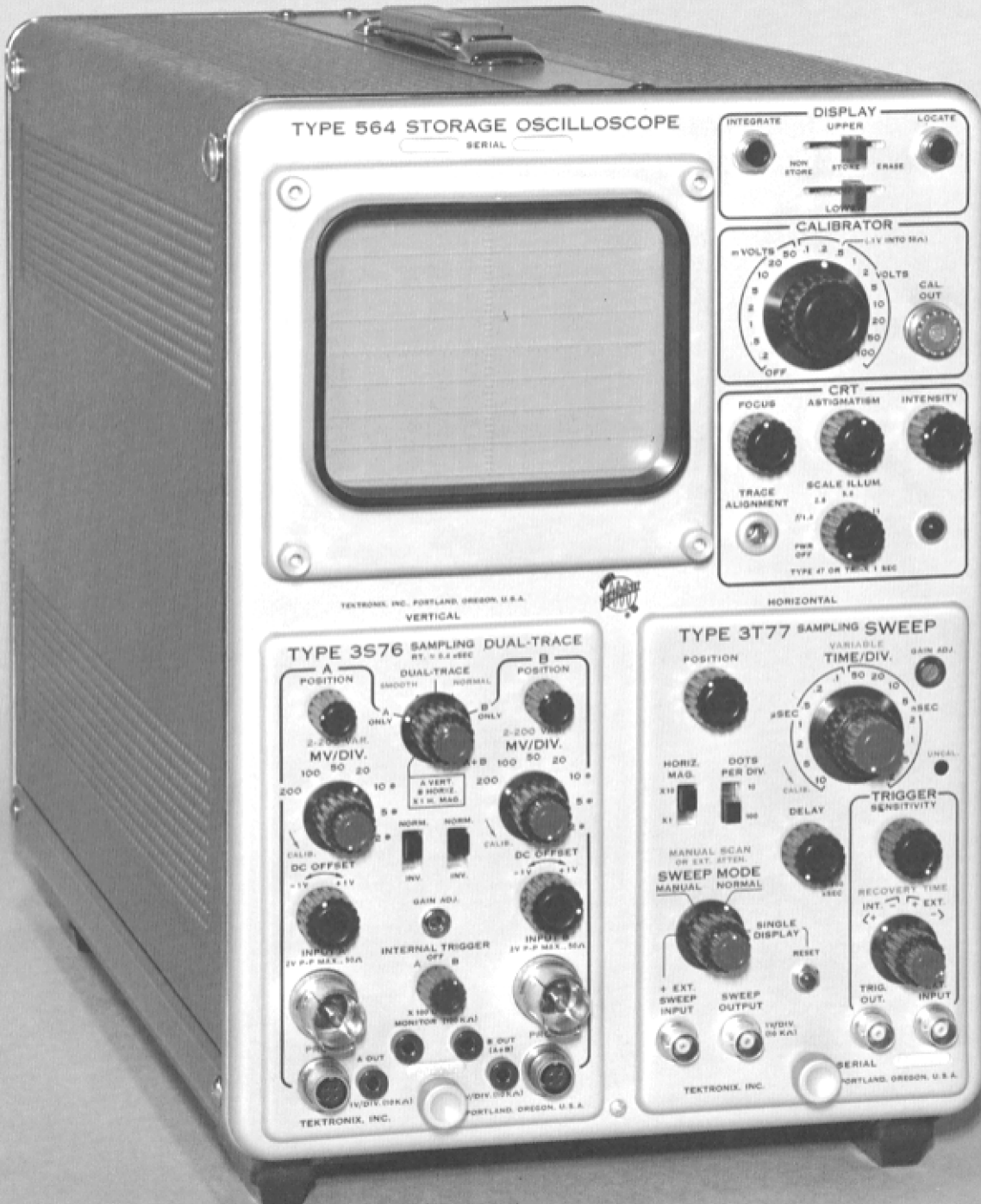

TYPE 564 STORAGE OSCILLOSCOPE
SERIAL

INTEGRATE DISPLAY LOCATE
UPPER
NON STORE STORE ERASE
LOWER

CALIBRATOR
mVOLTS 50 1 2 5 10 20 50 100
1V INTO 50A
VOLTS CAL OUT
OFF

FOCUS ASTIGMATISM INTENSITY
TRACE ALIGNMENT SCALE ILLUM. 1.1
PWR OFF TYPE 47 OR TYPE 1 SEC

TEKTRONIX, INC. PORTLAND, OREGON, U.S.A.



TYPE 3S76 SAMPLING DUAL-TRACE
RT. = 0.4 SEC

A POSITION DUAL-TRACE B POSITION
SMOOTH NORMAL
2-200 VAR. MV/DIV. 2-200 VAR. MV/DIV.
100 50 20 100 50 20
200 10 5 200 10 5
CALIB. DC OFFSET -1V +1V CALIB. DC OFFSET -1V +1V
GAIN ADJ. INTERNAL TRIGGER OFF B
INPUTS 2V P-P MAX. 50A 5.1KV MONITOR (500K Ω) INPUTS 2V P-P MAX. 50A
1V/DIV (50K Ω) 5 OUT (1A+8) 1V/DIV (50K Ω)

TYPE 3T77 SAMPLING SWEEP
VARIABLE TIME/DIV. GAIN ADJ.

POSITION 20 10 5 2 1 0.5 0.2 0.1 0.05 0.02 0.01 0.005 0.002 0.001
HORIZ. MAG. DOTS PER DIV CALIB. DELAY TRIGGER SENSITIVITY
MANUAL SCAN OR EXT. ATTEN. SWEEP MODE MANUAL NORMAL RECOVERY TIME INT. EXT.
+ EXT. SWEEP INPUT SWEEP OUTPUT (1V/DIV 50 K Ω) TRIG. OUT. INPUT

TEKTRONIX, INC. PORTLAND, OREGON, U.S.A.

SECTION 1

CHARACTERISTICS

General Description

The Type 564 Storage Oscilloscope is a special-purpose oscilloscope designed to store cathode-ray tube displays for viewing or photographing up to an hour after application of the input signal. In addition, the instrument can be operated as a conventional oscilloscope. The Type 564 is compatible with all Tektronix 2-Series and 3-Series plug-in units, thus it can be operated in a variety of modes including differential, multi-trace, wide-band, sampling and delayed sweep.

The two separate storage screens of the cathode-ray tube provide convenience and versatility for comparison and analysis of waveforms. Display storage is also convenient for detailed viewing and photography of single-sweep displays and extremely low-frequency waveforms (< 60 cps). You may use either the upper or lower storage screen in storage mode while the other screen is operated in non-store, or you may operate both screens together in either storage or non-store mode.

Cathode-Ray Storage Tube (Patents Pending)

Type — Tektronix-manufactured T5640-200 for the standard instrument; T5640-201 for the Type 564 (Mod 08) Oscilloscope. The crt is warranted under the Tektronix instrument warranty given in the front of this manual.

Envelope — Rectangular, 4-inch X 5-inch ceramic and glass; parallel-ground glass faceplate.

Screen — 8-cm X 10-cm viewing area divided into 4-cm X 10-cm upper and lower storage screens. Each screen has its own operating-level and erase circuitry for storage operation.

Accelerating Voltage — 3.5 kv.

Deflection — Electrostatic.

Deflection-Plate Sensitivity — Horizontal: approximately 18.5 volts/cm. Vertical: approximately 19.5 volts/cm.

Unblanking — Deflection-type, dc-coupled; ± 88 volts approximate cutoff.

Intensity Modulation — Internal: grid. External: cathode. Typically a 3-volt external signal will produce visible intensity modulation.

Focus — Electrostatic.

Storage Duration — At least one hour.

Erase Time — Approximately 250 msec.

Writing Speed, Brightness and Contrast — See Table 1-1 for minimum performance characteristics and Fig. 1-1 for expected crt life characteristics. The hours of operation shown are the hours the crt is used in the storage mode with repetitive writing, storing and erasing.

Writing Speed Increase* (using trace enhancement) — Approximately 10:1 for T5640-200 crt; approximately 5:1 for T5640-201 crt.

*Does not apply below 5/N 2000.

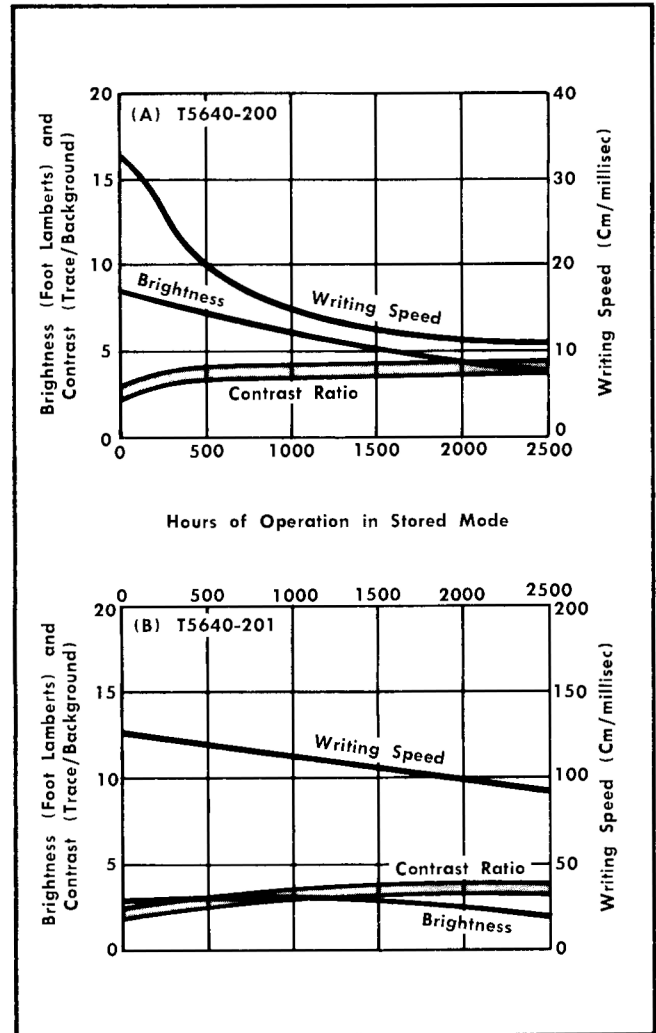

Fig. 1-1. Typical changes in writing speed, brightness and contrast for the T5640-200 and T5640-201 crts.

TABLE 1-1
Storage Screen Characteristics
(center 6 x 8 cm Area)

Characteristic	Type T5640-200	Type T5640-201
Minimum Initial Brightness	6 Foot-Lamberts	2 Foot-Lamberts
Minimum Initial Writing Speed (60 μ amp beam current)	25 Cm/mSec	100 Cm/mSec
Minimum Display-to-Background Contrast Ratio	2:1	2:1

Characteristics—Type 564

Graticule

Type — External.

Markings — 8 vertical and 10 horizontal 1-cm divisions; 2-mm marks along the vertical and horizontal centerlines.

Illumination — Variable edge lighting.

Calibrator

Waveform — Square-wave signal at power-line frequency.

Output Voltage — 0.2 millivolt to 100 volts peak-to-peak in 18 calibrated steps; within 3% of indicated voltage into high-impedance load. Output amplitude at .5 VOLTS position is 0.1 volt into a 50-ohm load.

Risetime — 5 μ sec or less.

Instrument Power

Line Voltage — 105 to 125 volts (117 volts nominal), or 210 to 250 volts (234 volts nominal), single-phase ac.

Line Frequency — 50 to 400 cps.

Voltage Regulation — $\pm 2\%$ over the applicable line-voltage range.

Power Consumption (with plug-in units) — Maximum of 250 watts.

Fuse — 3-amp slow-blowing type for 117-volt operation; 1.6-amp slow-blowing type for 234-volt operation.

Ventilation

Type — Convection air cooling.

Overheat Protection — 160° F thermal cutout interrupts instrument power if temperature exceeds safe operating level (ambient air 122° F maximum); restores power automatically when internal temperature drops below reset level of cutout (approximately 125° F).

Mechanical Characteristics

Construction — Aluminum-alloy chassis and cabinet. Side panels separately removable. Photo-etched anodized front panel; blue vinyl paint on remainder of cabinet.

Dimensions — Height: 13½ inches. Width: 9¾ inches. Depth: 21½ inches.

Weight — 30½ pounds without plug-in units.

Standard Accessories

1 — Polarized viewer, 016-039.

1 — 3-wire power cord, 161-010.

2 — Instruction manuals, 070-351.

1 — 3- to 2-wire adapter, 103-013.

2 — BNC to binding-post adapters, 103-033.

1 — Red test lead, 012-031.

Optional Accessories Available

Type 201-1 Scope-Mobile® cart with drawer, 016-045.

Type 201-2 Scope-Mobile® cart with plug-in carrier and drawer, 016-046.

Blank plug-in unit, 040-245.

®Registered trademark of Tektronix, Inc.

SECTION 2

OPERATING INSTRUCTIONS

General Information

All controls and connectors required for operation of the Type 564 Storage Oscilloscope are located on the front and rear panels of the oscilloscope and the front panels of the plug-in units. In order to be able to fully utilize the capabilities of the instrument, you should first familiarize yourself with the control functions and the various modes of operation. Basic operation of the Type 564 indicator unit is discussed in this section, and the storage modes of operation are illustrated in the form of demonstrations.

The oscilloscope crt display is formed in the same manner as that of a conventional oscilloscope, normally using a repetitive time-base sweep for horizontal deflection of the crt beam while the input voltage signal is displayed as vertical deflection. The amount of vertical displacement (input deflection factor) for any given input voltage is selected with the Volts/Div switch and Variable control on the amplifier plug-in unit. The rate of horizontal deflection (sweep rate) is selected by means of the Time/Div switch and Variable control on the time-base plug-in unit. Triggering of the sweep is provided by the time-base unit to start each sweep at the same point on the repetitive waveform. For detailed operation of the amplifier and time-base plug-in units, refer to the instruction manuals for the particular units.

In addition to displaying the input signal(s), the Type 564 is also able to store waveform displays so they will remain on the oscilloscope screen for extended periods of time. The two storage screens that make up the crt screen can be operated either independently (with respect to storage) or together, in either storage or non-store mode.

INSTALLATION

Cooling

The oscilloscope should be placed so that air can circulate freely about it. Ventilation is provided by convection through holes in the bottom and side panels. The Type 564 can operate in ambient temperatures up to 160° F. If the internal temperature becomes too high, a thermal cutout will open and disconnect the power until the temperature has returned to normal. If this occurs, check that the air circulation is not impaired. A constant temperature is important for accurate operation of the instrument.

Transformer Conversion

This instrument is wired to operate on the line voltage indicated on a metal tag adjacent to the power plug. Line frequency must be between 50 and 400 cps. The transformer primary is designed for convenient conversion to either 117 volts or 234 volts nominal line voltage. To convert from one voltage to the other, change the transformer primary connections as shown in Fig. 2-1 and change the power-line fuse as indicated on the rear panel of the instrument. When the transformer connections are changed, the voltage tag next to the power plug should also be changed. This may be done by replacing the old tag or covering it with one conforming

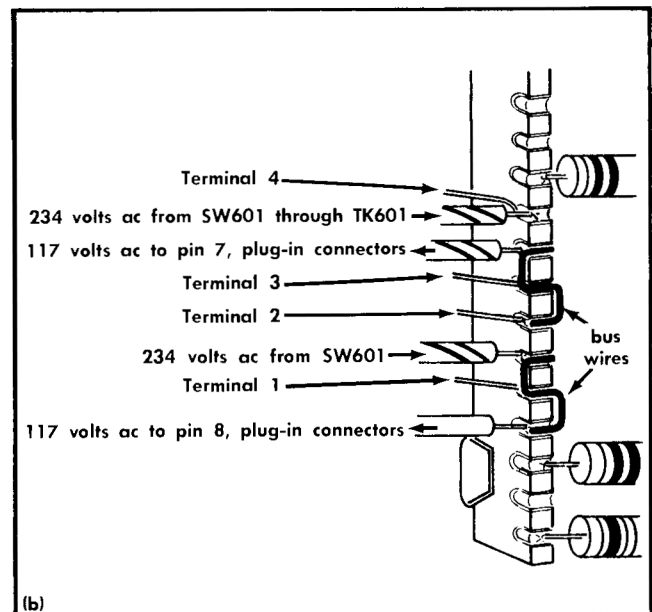
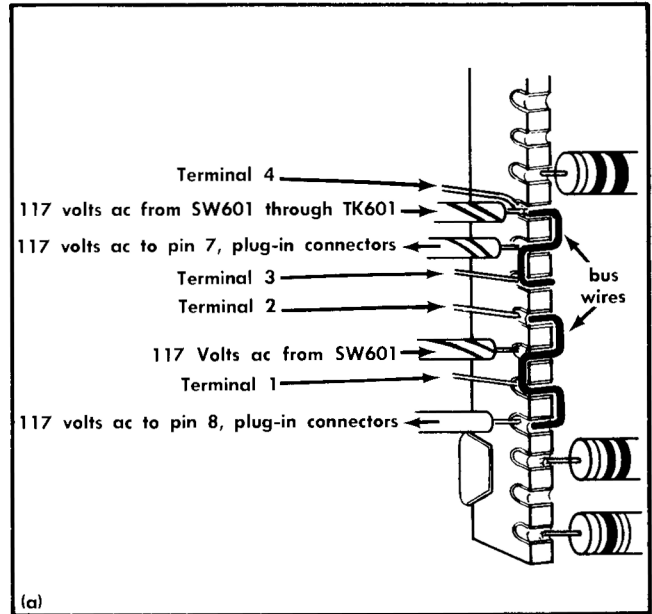

Fig. 2-1. Connections to transformer T601 primary terminals on ceramic strip behind horizontal plug-in compartment, for instruments S/N 2860 and above: (a) connected for 117-volt operation; (b) connected for 234-volt operation. Change only the bus wires for conversion. See text (Transformer Conversion) for earlier S/Ns.

to the new operating voltage, or by reversing the old tag and painting the new voltage on the blank side.

For instruments S/N 2000-2859, the wiring arrangement on the ceramic strip was slightly different from that illustrated, but identical electrically. Prior to S/N 2000, 117 volts ac

was not supplied to the plug-in units (pins 7 and 8 when wired for 234 volts). If desired, these instruments may be changed by reconnecting the bus wires and transformer leads as indicated.

SELECTION OF PLUG-IN UNITS

General Information

The Type 564 Oscilloscope is designed to use Tektronix 2-Series and 3-Series amplifier and time-base plug-in units to amplify the vertical input signal and to generate the time-base sweep. The use of plug-in units permits the selection of display modes, bandpass, sensitivity and number of inputs required for your particular application.

Changing Plug-In Units

To install a plug-in unit in the Type 564, push it all the way into the plug-in compartment, then turn the locking knob (at the bottom of the front panel) clockwise until it is tight. To remove the unit, turn the knob counterclockwise until the latch releases, then pull out the unit.

The accuracy of measurements made with the Type 564 depends on the calibration of the plug-in units used. Since the plug-in units drive the deflection plates directly, each unit must be adjusted to match the deflection sensitivity of the particular set of deflection plates that it drives. Therefore, the gain or sweep timing adjustment must be checked each time a plug-in unit is changed. On most units, gain or timing calibration is made with a front-panel screwdriver adjustment. (Sampling units require special adjustment procedures.) Refer to the plug-in unit instruction manual for the required procedure. Since the various plug-in units present different output voltage levels to the deflection plates, the FOCUS and ASTIGMATISM controls will also require readjustment.

Plug-in units can be changed without turning off the instrument power, but it is recommended that the power be turned off while the change is made. When the deflection and blanking voltages from the plug-in unit are disconnected from the oscilloscope (and during plug-in unit warm up), the spot that appears on the crt screen may burn the storage target, even at normal intensity.

CAUTION

Always turn the INTENSITY control fully counterclockwise while exchanging a plug-in unit, whether the power is left on or turned off. Increase the intensity only after the plug-in unit has had about $\frac{1}{2}$ minute to warm up.

Either or both of the plug-in units can be operated on special extension cables (Tektronix part number 012-066) for circuit checking. For normal operation, however, the units should be installed in the oscilloscope. If the instrument is operated with the plug-in units on extension cables, the high-frequency response and fast sweep rates will be affected slightly.

Display Combinations

The plug-in unit in the left plug-in compartment controls the vertical (Y-axis) deflection of the crt beam and the unit

in the right plug-in compartment controls the horizontal (X-axis) deflection. To produce a normal time-base display, an amplifier plug-in unit is used in the vertical (left) plug-in compartment and a time-base plug-in unit is used in the horizontal (right) plug-in compartment.

Other combinations of plug-in units can be used for other types of displays. For example, two amplifier units may be used to produce an X-Y display for phase comparison measurement. Plug-in units with equal phase shift will produce an accurate X-Y display.

The amplifier and time-base units may also be interchanged to produce a display with vertical sweep. If a vertical sweep is used, however, there is no retrace blanking, delaying-sweep intensification does not operate and the LOCATE pushbutton does not function.

The use of a dual-trace or multi-trace amplifier unit permits simultaneous viewing of two or more signals. For a multi-trace amplifier unit with single-channel trigger capability ("Channel 1 Trigger"), the trigger signal is applied through the Type 564 to the trigger circuit in the time-base unit. This permits triggering from a single input signal and the crt display shows the time relationship between the various signals. Without single-channel triggering, an external trigger is required to establish time relationship in multi-trace displays. In chopped mode, the multi-trace blanking pulses from the amplifier unit are applied internally through the Type 564 to the crt cathode (with the rear-panel CRT CATHODE SELECTOR switch at CHOPPED BLANKING) to blank the crt beam while it is switched from one channel to another.

A delayed-sweep time-base unit is convenient for detailed viewing of pulse-train segments that occur a relatively long time after the maximum-amplitude (triggering) portion of the signal. The portion of the pulse train to be displayed by the delayed sweep may be intensified on the delaying-sweep display. A delayed-sweep unit that has a calibrated time delay can also be used for making very accurate time measurements.

The equivalent bandpass of the oscilloscope can be increased to as much as 1 gigacycle through the use of sampling plug-in units. A sampling time-base unit must be used with a sampling amplifier unit in the Type 564 in order to produce the sampling display (even for X-Y operation). Sampling and conventional plug-in units cannot be used together in the oscilloscope.

For special applications, the Type 564 can be operated with only one plug-in unit installed. When this is done, the set of deflection plates that is not connected to a plug-in unit must have dc voltages of approximately +180 volts applied to them from a low-impedance source (20 k or less) to permit focusing of the display. If the source impedance is too high, flood-gun current will cause incorrect operation of the crt.

Custom Plug-In Units

Blank-chassis plug-in units can be purchased through your local Tektronix Field Office as Modification Kit number 040-245. These blank chassis permit you to build your own plug-in circuitry for use in the Type 564. The power drawn from any of the regulated supplies should not exceed that of standard plug-in units. However, the nature of series-reg-

ulated power supplies permits the use of some additional current by placing a shunt resistor of appropriate value across the series regulator tube. Use Table 2-1 as a guide for selecting the shunt resistors if additional current is required.

The value of the shunt resistor must be chosen to permit the regulator system to deliver current with low ripple, and the resistor must have a power rating high enough to carry its share of current without overheating. Current limits of the -100-volt, +125-volt, and +300-volt dc supplies are given in Table 2-1. The currents are based upon the total current being divided equally between the two plug-in units. Do not shunt any other supply.

To use the -12.2-volt regulated heater supply in your own plug-in unit design, run two parallel leads from pins 5 and 16 of the interconnecting plug to the heater pins, to avoid chassis ground currents. Up to 800 ma of current is available from the -12.2-volt supply.

TABLE 2-1
Power Supply Current Limits

Shunt Resistor Value	Available Current		
	-100-volt Supply, Pins 22 and 9	+125-volt Supply, Pins 20 and 15	+300-volt Supply, Pins 6 and 10
No Shunt	0 to 25 ma	0 to 45 ma	0 to 40 ma
2 kΩ, 5 w between pins	20 to 45 ma	25 to 60 ma	35 to 67 ma
Short between pins	40 to 65 ma	50 to 75 ma	65 to 75 ma

FUNCTIONS OF CONTROLS AND CONNECTORS

Controls and connectors on the front and rear panels of the Type 564 are shown in Fig. 2-2.

DISPLAY

Upper DISPLAY Switch	Selects storage (STORE) or non-store (NON STORE) mode of operation for upper half of crt screen; erases stored display when switch is pressed to ERASE, then released.
Lower DISPLAY Switch	Selects storage (STORE) or non-store (NON STORE) mode of operation for lower half of crt screen; erases stored display when switch is pressed to ERASE, then released.
LOCATE Push-button Switch	Displays a dot or line in the non-storing area at left edge of screen to locate vertical position of signal while sweep is held off. This permits display to be positioned before storing.
INTEGRATE Push-button Switch	Permits storage of repetitive displays that exceed the normal writing speed of the storage screens.
WRITING RATE INCREASE (PULL ON) Switch and Control*	Permits storage of non-repetitive events beyond the normal writing speed of the storage screens.

*S/N 2000-up.

CALIBRATOR

CALIBRATOR Switch	Sets amplitude of power-line frequency square-wave signal available at CAL OUT connector; turns off Calibrator when knob is turned fully counterclockwise. Peak-to-peak square-wave amplitude is selected from 18 calibrated steps ranging from 0.2 millivolts to 100 volts into high impedance; amplitude is 0.1 volt at .5 VOLTS position when CAL OUT is terminated in 50 Ω.
CAL OUT Connector	Provides Calibrator square-wave output for checking gain of amplifier units and for adjusting probe compensation (use dc-coupling at vertical input). Amplitude of output signal is controlled by CALIBRATOR switch.

CRT

FOCUS Control	In conjunction with ASTIGMATISM control, adjusts focus of spot or trace. Adjust FOCUS for equal focus of vertical and horizontal segments of display or equal dimensions of spot.
ASTIGMATISM Control	In conjunction with FOCUS control, adjusts focus of spot or trace. Adjust ASTIGMATISM for minimum trace width or spot diameter.
INTENSITY Control	Adjusts writing-gun display brightness to allow for different sweep or triggering rates. Rotate control clockwise to increase display brightness; counterclockwise to decrease brightness. (Does not change brightness of stored display.)

CAUTION

Excessive intensity can damage the storage screen. Use minimum intensity necessary to view or store the display. See the precautionary suggestions given below under "Care of Storage Screens".

TRACE ALIGNMENT Control	Rotates crt display to align it with horizontal graticule markings. Check trace alignment after moving instrument, since alignment is affected by earth's magnetic field.
SCALE ILLUM Control and Power Switch	Applies line power to low-voltage transformer; controls intensity of graticule illumination. Rotate control clockwise to turn on instrument and increase illumination; rotate counterclockwise to decrease illumination and turn off instrument (PWR OFF position).
Pilot Light	Indicates that ac power is applied to low-voltage supplies.

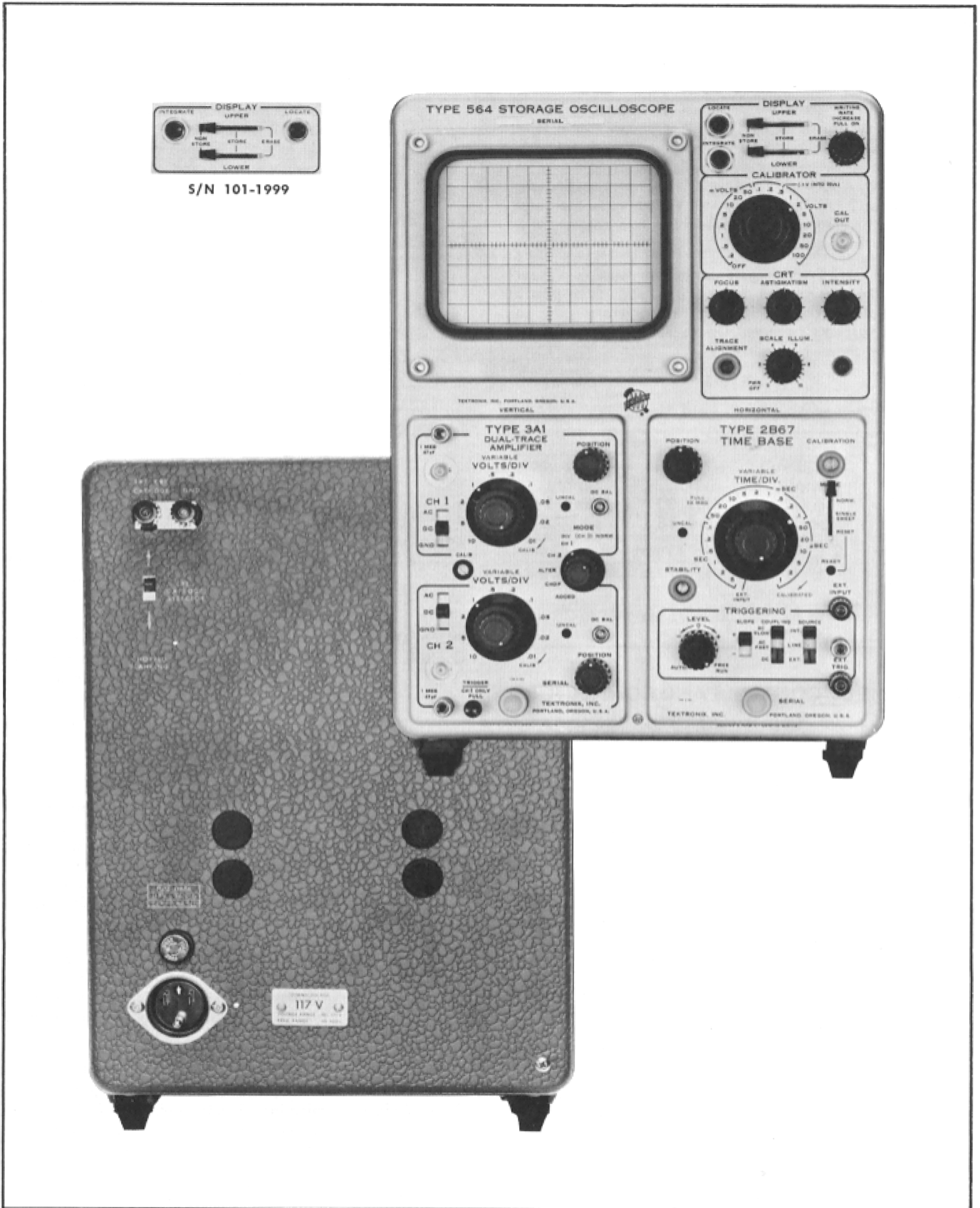

Fig. 2-2. Front- and rear-panel controls and connectors.

REAR PANEL

EXT CRT CATHODE Binding Post	Permits application of external signal (ac-coupled) for intensity modulation. Positive-going voltage signal decreases intensity; negative-going signal increases intensity. A 3-volt change will produce appreciable modulation. Remove ground strap and set CRT CATHODE SELECTOR switch to EXT CRT CATHODE position when applying external signal.
GND Binding Post	Provides chassis ground for EXT CRT CATHODE connector when no external signal is being applied, to eliminate stray intensity modulation.
CRT CATHODE SELECTOR Switch	Selects intensity modulation from dual-trace amplifier chopped circuit (with switch at CHOPPED BLANKING) or from external signal applied through EXT CRT CATHODE connector (with switch at EXT CRT CATHODE). Leave switch at EXT CRT CATHODE except when using chopped mode.
Input Connector Holes	Permit installation of auxiliary inputs and outputs through rear panel.
Fuse	Limits power transformer primary current to prevent overload. Always use correct fuse for your line voltage, as indicated on rear panel.

Calibrated Graticule

The edge-lighted graticule is accurately marked with 10 horizontal and 8 vertical 1-centimeter divisions and has 2-millimeter subdivisions on the vertical and horizontal centerlines. The gain and timing of the plug-in units are calibrated to these graticule marks, thus the marks provide a calibrated scale for making voltage and time measurements.

CAUTION

Never operate the instrument without a graticule or implosion shield on front of the crt.

Positioning and Deflection Controls

All of the controls related to vertical and horizontal deflection and positioning are contained in the amplifier and time-base plug-in units. Refer to the instruction manuals of the specific units for operation of these controls. Refer also to the time-base unit manual for the use of sweep triggering controls.

FIRST-TIME OPERATION

The following procedure, using normal single-channel time-base mode, illustrates the basic operation of the Type 564 and its plug-in units.

1. Install a 2-Series or 3-Series amplifier plug-in unit in the vertical (left) plug-in compartment and a 2-Series or 3-Series time-base plug-in unit in the horizontal (right) plug-in compartment. Lock the plug-in units in place with their locking screws.

2. With the SCALE ILLUM control set to PWR OFF, connect the power cord from the Type 564 to the proper line voltage, indicated on the tag adjacent to the power plug.

NOTE

If the instrument is wired for 117 volts, it will operate properly from 105 to 125 volts. If wired for 234 volts, it will operate from 210 to 250 volts.

3. Install the polarized viewing hood on the graticule cover. The rivet through the top of the hood fits into the hole in the top of the graticule cover flange.

4. Set the instrument controls as follows:

TYPE 564

Upper DISPLAY	NON STORE
Lower DISPLAY	NON STORE
WRITING RATE INCREASE*	Off (pushed in)
CALIBRATOR	2 VOLTS
FOCUS	Centered
ASTIGMATISM	Centered
INTENSITY	Counterclockwise
CRT CATHODE SELECTOR	EXT CRT CATHODE

Amplifier Unit

Position	Centered
Mode	Normal (Channel 1)
Volts/Div	2
Variable	Calibrated
Input Coupling	DC

Time-Base Unit

Position	Centered
Time/Div	5 msec
Variable	Calibrated
Magnifier	Off
Sweep Mode	Normal
Level	Free Run
Triggering Source	Internal
Slope	+
Coupling	AC

5. Connect a coaxial cable from the CAL OUT connector to the input connector of the amplifier plug-in unit (Channel 1).

6. Turn on the power switch (SCALE ILLUM) and allow a few minutes for warm up.

7. Adjust the INTENSITY control to obtain a display of moderate brightness. The amplifier unit Position control may have to be readjusted to position the free-running trace on the crt screen. Do not turn the intensity higher than is necessary for adequate observation of the display.

8. Trigger the display with the time-base Level control.

9. Set the SCALE ILLUM control so the graticule illumination is approximately equal to the intensity of the display.

*S/N 2000-up.

Operating Instructions—Type 564

10. Adjust the time-base Position control to position the start of the trace at the left edge of the graticule.
11. Adjust the FOCUS control for equal focus of the horizontal and vertical segments of the display.
12. Adjust the ASTIGMATISM control for sharpest focus of the trace.
13. Adjust the TRACE ALIGNMENT screwdriver adjustment to align the display with the horizontal graticule lines.
14. Check the gain and dc balance of the amplifier unit and the timing adjustment of the time-base unit as given in the instruction manuals for these units before making any voltage or time measurements.

Check Operating Level

The operating level (storage level) of the storage screens should be checked after each 300 hours of operation to ensure optimum storage operation at all times. See the Storage Circuit portion of the calibration procedure for the storage level adjustment.

CARE OF STORAGE SCREENS

To prolong the useful life of the storage screens, always observe the following precautions when operating the Type 564:

1. USE MINIMUM BEAM INTENSITY required to produce a clear, well-defined display. Special care should be taken during warm up and when using slow sweep rates and sampling displays.

CAUTION

Care must be observed in the degree of writing-beam intensity that is used. High writing-beam current can cause permanent damage to the storage target.

2. TURN INTENSITY CONTROL TO MINIMUM WHEN CHANGING PLUG-IN UNITS. An undeflected spot on the crt screen can burn the storage target, even at normal intensity.
3. DO NOT INCREASE BEAM INTENSITY TO STORE FAST-CHANGING PORTIONS OF WAVEFORM. See instructions given later in this section for storing fast-rise waveforms.
4. AVOID REPEATED USE OF THE SAME AREA of the screen.
5. DO NOT LEAVE DISPLAY ON CRT SCREEN (either writing or stored) when the display is not needed.
6. DO NOT LEAVE DISPLAY SWITCHES AT STORE when storage mode is not needed.

Due to the nature of the storage screens, certain trace or waveform images may appear to remain on the screens, even after they have been "erased" with the DISPLAY switches. These images generally fall into the following three categories:

1. "Negative image" — A dark waveform image that appears as a darker background light level when the DISPLAY switches are set to STORE. Negative images result from

writing or storing a waveform in one position on the screen for a relatively long period of time. They will usually disappear in a short time, but may temporarily decrease the writing speed of the affected area.

2. "Bright burn" — A bright waveform image that is visible when the storage screens are set to the fade-positive level*. Bright burns are caused by excessive intensity of the writing-gun beam. Severe burns may remain indefinitely.

NOTE

The appearance of a damaged target can sometimes be improved by adjusting the backplate voltage to the fade-positive level* and leaving it there for about 30 minutes. Unless the residual images are causing annoyance, however, it is best to allow them to disappear gradually. Extended fade-positive operation decreases the stored-mode life expectancy.

3. "Dark burn" — A spot or line on the screen that will not write or store a trace. Dark burns result from destructive burning of the storage target by the writing-gun beam. This type of burn is the same as phosphor burn in a conventional crt. Replacement of the storage tube will be required if dark burns impair operation of the instrument.

NON-STORE OPERATION

Operation of the Type 564 in the non-store mode is essentially the same as that of a conventional general-purpose oscilloscope. The various display modes that are possible with a particular pair of plug-in units are described in the instruction manuals for those units. Refer to the amplifier unit manual for the following: compensation of probes; selection and use of input cables, coupling and attenuation; measurement of input signal voltage and phase (X-Y). Refer to the time-base unit manual for selection of triggering sources and coupling and for measurements of time intervals, frequency and phase (linear measurement).

STORAGE MODE

In the storage mode, the writing-gun and deflection circuits operate the same as in non-store mode. However, the storage circuits and storage controls are unique and require operating information not given in the plug-in unit manuals. The following demonstrations are intended to illustrate the various types of stored displays that are possible and the techniques required to obtain them.

Repetitive-Sweep Storage

Slow and Medium Sweep Rates

This method of storage is used for repetitive waveforms that produce normally bright displays on the crt screen.

1. Set up a calibrator waveform display as described in "First-Time Operation".

2. Center the waveform vertically on the crt screen so that part of the waveform is above the horizontal centerline and part of it is below the centerline.

*Fade-positive level: Storage-target backplate voltage that causes the entire screen background to appear bright (stored).

3. Turn the INTENSITY control fully counterclockwise.
4. Press both DISPLAY switches to ERASE, then release them to STORE position. The normal storage-mode background light level will be present on the storage screens.
5. Advance the INTENSITY control slowly in the clockwise direction to produce a waveform display of normal intensity, then return the control to the minimum (counterclockwise) position. A stored waveform of moderate brightness should remain.
6. Press the Upper DISPLAY switch to ERASE and release it. Note that only the portion of the stored image on the upper storage screen (the upper half of the crt screen) has been erased.
7. Set the Upper DISPLAY switch to NON STORE. The image on the lower screen will not be affected when the upper screen is switched to non-store mode.
8. Press the Lower DISPLAY switch to ERASE and release it. The remainder of the stored image is now erased.
9. Set the Lower DISPLAY switch to NON STORE.
10. Increase the intensity to produce a normal display.
11. Position the entire waveform on the upper screen with the amplifier Position control.
12. Turn the INTENSITY control fully counterclockwise.
13. Press only the Upper DISPLAY switch to ERASE and release it.
14. Increase the INTENSITY control to the normal display level, then return it to the minimum position. The waveform is now stored on the upper screen only, operating independently.
15. The demonstration may be repeated using only the lower screen in storage mode.
16. At the end of the demonstration, set the DISPLAY switches to NON STORE.

NOTE

Whenever one of the DISPLAY switches is moved from NON STORE to STORE, press it to the ERASE position momentarily before storing a display.

Repetitive Trace Location

The LOCATE button permits the trace to be located while the sweep is held off, so that it can be positioned to a new level before storing.

1. Set up a non-store calibrator display as in "First-Time Operation".
2. Store a display on the upper screen only, as in the preceding demonstration. (The Lower DISPLAY switch should be at NON STORE.)
3. Set the time-base Mode switch to Single Sweep.
4. Press the LOCATE pushbutton and hold it in.
5. Advance the INTENSITY control slowly until two dots of normal intensity appear at the left edge of the stored waveform.

6. With the LOCATE button still held in, turn the amplifier unit Position control to position the two dots to the left edge of the lower storage screen (see Fig. 2-3).
7. Release the LOCATE button.
8. Set the time-base Mode switch to Normal. The waveform on the lower screen is now displayed in non-store mode while the upper screen is in the storage mode.
9. Turn the INTENSITY control fully counterclockwise.

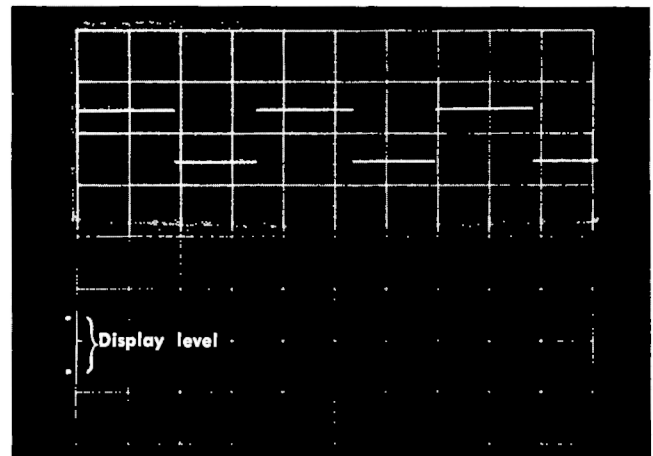

Fig. 2-3. Use of the LOCATE button for positioning the display level while the sweep is held off.

10. Press the Lower DISPLAY switch to ERASE and release it.
11. Increase the intensity to normal, then return the INTENSITY control to the minimum position. Both screens should now have stored calibrator waveforms.
12. At the end of the demonstration, set the DISPLAY switches to NON STORE.

NOTE

For positioning repetitive displays, always turn off the sweep (Mode to Single Sweep) before pressing the LOCATE button. Be sure the waveform is positioned so the sweep starts at the left edge of the graticule. The LOCATE button cannot be used conveniently with the sweep magnifier on, due to the horizontal repositioning required.

Integrated Fast Displays

The INTEGRATE pushbutton switch permits storage of fast repetitive sweeps that approach or exceed the normal writing speed of the instrument. Do not use the INTEGRATE button (as described in this demonstration) at slow or medium sweep rates unless the repetition rate is very low.

1. Set up the calibrator display as in "First-Time Operation", then reset the following controls:

Time-Base Level	Free Run
Time/Div	1 μ sec
Volts/Div	.5

Operating Instructions—Type 564

2. Trigger the display on the rising portion of the calibrator square wave. This will require increasing the display intensity to view the trace.

3. Focus the trace with the FOCUS and ASTIGMATISM controls.

4. Press the DISPLAY switches to ERASE and release them. Note that the trace will not store.

5. Adjust the INTENSITY control for a barely visible trace and readjust the focus if necessary.

6. Press the DISPLAY switches to ERASE and release them.

7. Press the INTEGRATE button and hold it in for about 10 seconds.

8. Release the INTEGRATE button. A stored trace should be present on the screen (see Fig. 2-4). If not, repeat the demonstration and hold the INTEGRATE button for a few seconds longer.

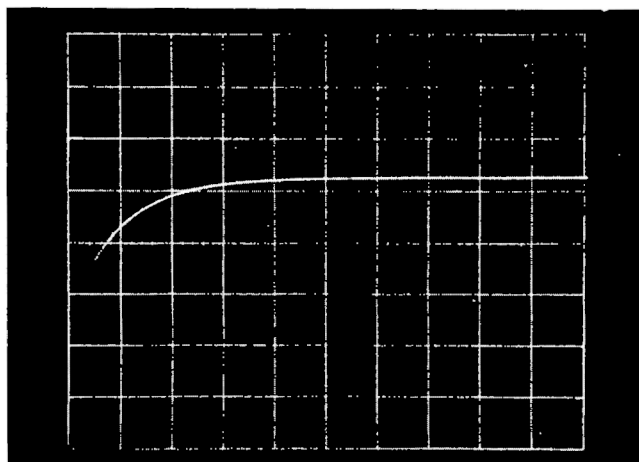

Fig. 2-4. Stored display of calibrator rise using the INTEGRATE button, at 1 μ sec/cm sweep rate.

9. At the end of the demonstration, turn the INTENSITY control fully counterclockwise and set the DISPLAY switches to NON STORE.

NOTE

When using the INTEGRATE button, if the signal has time-jitter, portions of the stored display may blur or thicken, since the sweeps do not repeat at exactly the same position on the screen.

Fast-Rise Waveforms

The INTEGRATE button, when used in conjunction with the INTENSITY control as described in this demonstration, permits the storage of relatively fast-rising and fast-falling portions of a waveform. This method may also be used for producing a high-resolution display of any waveform.

1. Connect a 25-kc square-wave signal ($T_r \approx 20$ nsec) to the amplifier unit input.

2. Set the controls as given in "First-Time Operation", except for the following:

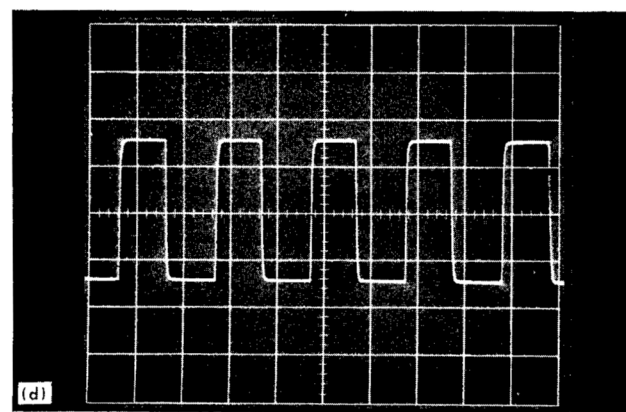
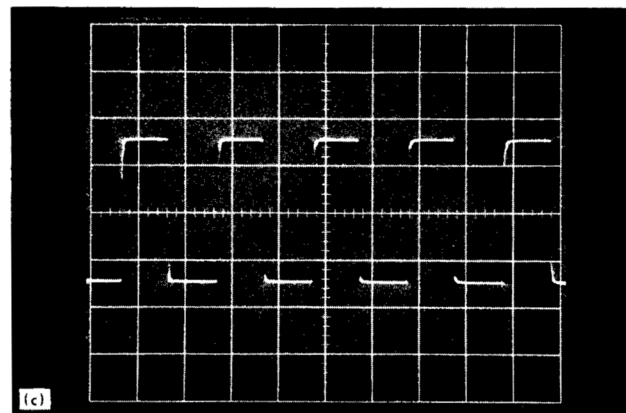
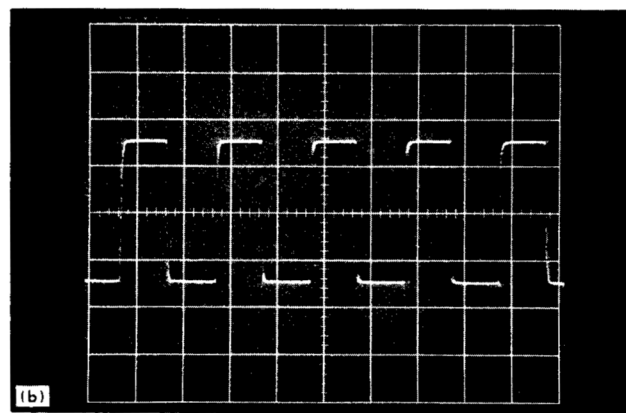
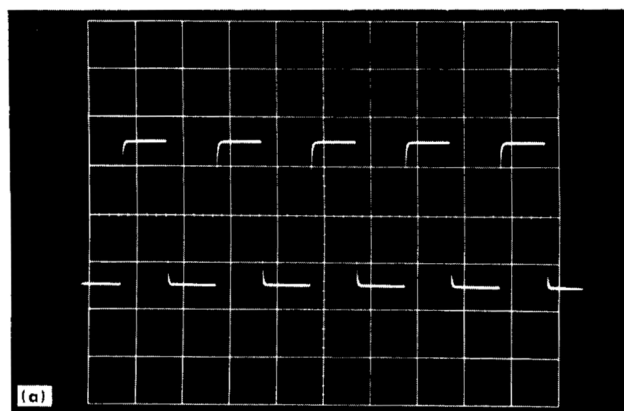

Fig. 2-5. Storage of fast-rise waveform showing difference in storage techniques: (a) non-store display; (b) stored with INTENSITY control alone; (c) stored with INTEGRATE button; (d) stored with INTEGRATE button and INTENSITY control as described in text.

Time/Div 20 μ sec
 Volts/Div 10

3. Adjust the INTENSITY control for normal brightness of the free-running trace.
4. Adjust the amplifier Volts/Div switch and the square-wave amplitude to produce about 3 major divisions of vertical deflection on the crt screen.
5. Trigger the square-wave display and adjust the focus.
6. Set the DISPLAY switches to STORE and attempt to store the waveform by the previous methods. Note that even though the vertical portions of the waveform are visible when the writing beam is displayed, they cannot be stored well with the methods described previously.
7. Turn the INTENSITY control fully counterclockwise.
8. Press the DISPLAY switches to ERASE and release them.
9. Press the INTEGRATE button and hold it.
10. Advance the INTENSITY control until the vertical portions of the trace are just barely visible (using the polarized viewing hood).
11. Hold the INTEGRATE button in for about 20 seconds, then turn the INTENSITY control to minimum while the INTEGRATE button is still pressed.
12. Release the INTEGRATE button. Both the horizontal and vertical segments of the display should now be stored (see Fig. 2-5).

13. Repeat this demonstration several times using slightly different intensity levels and integrating for different lengths of time. Best resolution is generally produced by using very low intensity and integrating for a long period (many seconds). However, using this method, only the portions of the trace that can be seen (at least dimly) will be stored.

CAUTION

Do not attempt to store extremely fast-rising or fast-falling portions of waveforms viewed at relatively slow sweep rates. The high trace intensity required (due to the intensity difference between the horizontal and vertical segments) would cause storage-target damage.

14. At the end of the demonstration, turn the INTENSITY control fully counterclockwise and set the DISPLAY switches to NON STORE.

Single-Sweep Storage

Slow and Medium Sweep Rates

This method of storage is used for single-sweep displays that produce crt traces of adequate intensity.

1. Set up a normal-intensity non-store calibrator display as in "First-Time Operation".
2. Set the time-base Mode switch to Single Sweep.
3. Press the DISPLAY switches to ERASE and release them.

4. Apply a single sweep of the trace. A stored display of the calibrator waveform should remain on the storage screen. If not, repeat the demonstration with the display intensity increased slightly.

5. At the end of the demonstration, reset the following controls:

INTENSITY	Counterclockwise
DISPLAY (both)	NON STORE
Time-base Mode	Normal

Single-Sweep Trace Location

The LOCATE button permits trace positioning while the sweep is held off, but the technique of operation is slightly different from that used in repetitive mode.

1. Connect a 10-kc square-wave or sine-wave signal to the amplifier unit input.
2. Set the controls as given in "First-Time Operation", except for the following:

Volts/Div	10
Time/Div	50 μ sec

3. Adjust the INTENSITY control for normal brightness of the free-running trace.
4. Adjust the amplifier Volts/Div switch and the signal amplitude to produce approximately 2 cm of deflection on the crt screen.
5. Trigger the display.
6. Position the display entirely on the upper storage screen.
7. Set the time-base Mode switch to Single Sweep.
8. Apply several single sweeps of the trace while adjusting the INTENSITY, FOCUS and ASTIGMATISM controls for a well-defined single-sweep display.
9. Press the Upper DISPLAY switch to ERASE and release it.
10. Apply a single sweep of the trace to store the display.
11. Turn down the intensity to the approximate level required for a repetitive sweep.

NOTE

It is important to turn down the intensity before pressing the LOCATE button. Flaring will occur at the left edge of the stored display if the intensity is not decreased.

12. Press the LOCATE button and hold it in. If the line or set of dots at the left edge of the screen is not at normal intensity, readjust the INTENSITY control slightly.
13. While pressing the LOCATE button, position the display to the lower screen.
14. Release the LOCATE button.

Operating Instructions—Type 564

15. Apply several single sweeps and readjust the INTENSITY control to the single-sweep level.

16. Press the Lower DISPLAY switch to ERASE and release it.

17. Apply a single sweep of the trace to store a display on the lower screen. Both screens should now have stored single-sweep displays.

18. At the end of the demonstration, reset the following controls:

INTENSITY	Counterclockwise
DISPLAY (both)	NON STORE
Time-base Mode	Normal

Fast Sweep Enhancement

The WRITING RATE INCREASE control* provides a method of storing single-event displays that exceed the normal writing speed of the instrument. This mode is not normally used for repetitive sweeps.

1. Apply a 25-kc square-wave signal ($T_r \approx 20$ nsec) to the amplifier unit input.

2. Set the controls as given in "First-Time Operation", except for the following:

Volts/Div	10
Time/Div	10 μ sec (2 μ sec for T5640-201 crt)

3. Adjust the INTENSITY control to observe the trace.

4. Set the amplifier Volts/Div switch and the square-wave amplitude to display about 3 major divisions of deflection.

5. Trigger the display.

6. Set the time-base Mode switch to Single Sweep.

7. Apply several single sweeps of the trace and advance the INTENSITY control to observe the display.

CAUTION

Do not allow the time-base Mode switch to be set to Normal while the intensity is set at a high level.

8. Adjust the FOCUS and ASTIGMATISM controls for the best focus.

9. Press the DISPLAY switches to ERASE, then release them.

10. Apply a single sweep of the trace. Note that the trace will not store.

11. Pull out the WRITING RATE INCREASE control and turn it to about midrange.

12. Apply a single sweep of the trace. The display should now store.

13. Erase the screens and repeat the demonstration several times using different settings of the WRITING RATE

*Trace-enhancement circuit and WRITING RATE INCREASE control added at S/N 2000.

INCREASE control. After a trace is stored, turn off (push in) the WRITING RATE INCREASE control to avoid accidental operation of the enhancement circuit.

NOTE

Whenever the WRITING RATE INCREASE control is used, it affects both storage screens. In this mode of operation, because of background positive fading, it is not normally possible to produce a stored display of more than about 1 or 2 traces.

14. At the end of the demonstration, reset the following controls:

INTENSITY	Counterclockwise
WRITING RATE INCREASE	Off (pushed in)
DISPLAY (both)	NON STORE
Time-base Mode	Normal

INTENSITY MODULATION

Intensity (Z-axis) modulation can be used to relate other voltage information to the displayed signal without changing the shape of the waveform. The modulation signal is applied to the crt cathode through the rear-panel EXT CRT CATHODE binding post. With the INTENSITY control set correctly, positive pulses between 3 and 50 volts in amplitude will dim or blank the crt beam, and negative pulses between 3 and 50 volts in amplitude will brighten the beam.

Time markers may be applied for direct time reference of the display or for establishing the sweep rate when uncalibrated deflection is used. Fast-rise pulses of short duration provide best resolution with respect to time. If the markers are not time-related to the displayed waveform, a single-sweep display is required. If sine waves are used, the minimum useable frequency is about 250 cps, due to ac-coupling at the input. Be sure to ground the EXT CRT CATHODE connector when it is not in use, to avoid random intensity modulation from stray signals.

Since there is only one intensity level in a stored display, modulation can be stored only by modifying the display in some manner. The stored waveform may be modified by one of the following methods: dimming the modulated portions of the waveform so they do not store; brightening the modulated portions from a dim background so only the modulated portions store; widening the modulated portions by superimposing a defocused modulated display over the normal stored waveform. The following demonstrations illustrate these methods of modulation.

Modulation by Positive Blanking

The best intensity-modulated stored displays are usually produced by applying positive modulation pulses that lower the intensity of the modulated portions below the storage threshold.

1. Connect a 10- μ sec time-mark signal to the amplifier input.

2. Unground the EXT CRT CATHODE binding post and apply a 30-volt (approx.) 1- μ sec positive-going time-mark signal.

3. Set controls as in "First-Time Operation", except for the following:

Volts/Div 2
 Time/Div 2 μ sec

4. Advance the INTENSITY control to display a dim trace on the crt screen.

5. Trigger the display with the time-base Level control. The display should consist of 10- μ sec time markers with blanked portions occurring every 1 μ sec.

6. Adjust the deflection factor for about 3 major divisions of deflection.

7. Press both DISPLAY switches to ERASE, then release to STORE.

8. Use the Fast-Rise Waveform storage procedure described previously to store the modulated display. When the operation is performed correctly, only the unmodulated portions of the display should be stored (see Fig. 2-6a).

9. At the end of the demonstration, turn the INTENSITY control fully counterclockwise and set the DISPLAY switches to NON STORE.

Modulation by Negative Intensification

1. Connect a coaxial cable from the CAL OUT connector to the input connector of the amplifier unit.

2. With the EXT CRT CATHODE binding post ungrounded, apply a 30-volt 1-kc negative-going square wave to the binding post.

3. Set the controls as in "First-Time Operation".

4. Advance the INTENSITY control to display a dim trace on the crt screen.

5. Trigger the display with the time-base Level control. The display should consist of about 3 cycles of the calibrator waveform made up of 1-kc intensified dots.

6. Set the time-base Mode switch to Single Sweep.

7. Press the DISPLAY switches to ERASE and release to STORE.

8. Store the modulated calibrator waveform using the single-sweep method of storage described previously. (Single sweep must be used for modulation that is not time-related to the input signal.) The stored display should consist of only the display segments that are intensified by modulation (see Fig. 2-6b).

Trace-Width Modulation

Leave the equipment set up as at the end of the preceding demonstration.

1. Note the position of the FOCUS control at the point of best focus, then turn the control approximately 30° counterclockwise from that point.

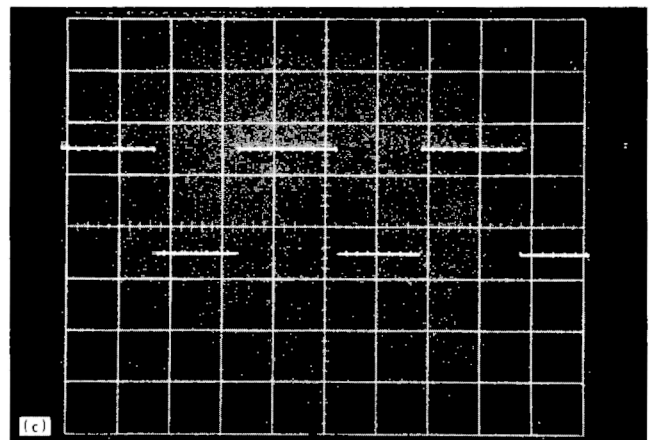
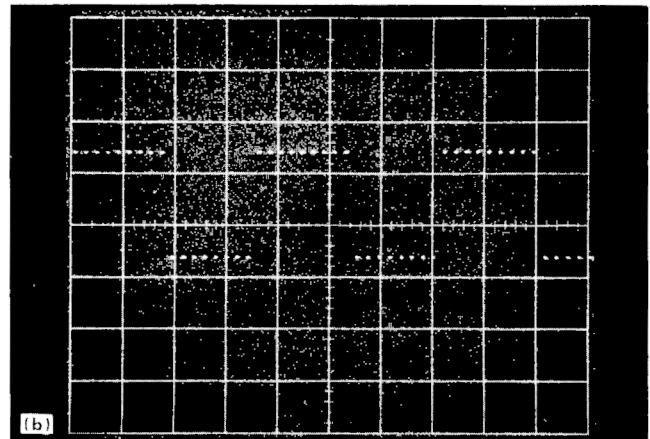
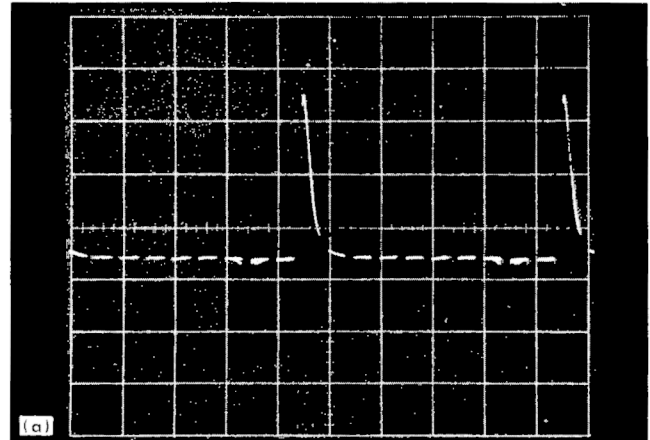

Fig. 2-6. Three modes of intensity modulation for display storage: (a) positive-pulse blanking; (b) negative-pulse intensification; (c) trace widening. Displays are described in text.

2. Press the DISPLAY switches to ERASE and release to STORE.

3. Store a single sweep of the modulated calibrator waveform.

4. Reset the following controls (in the order given):
- | | |
|----------------------|------------------|
| INTENSITY | Counterclockwise |
| CRT CATHODE SELECTOR | CHOPPED BLANKING |
| Time-base Mode | Normal |

Operating Instructions—Type 564

5. Return the FOCUS control to the point of best focus.
6. Advance the INTENSITY control to store a normal-intensity focused trace superimposed on the stored defocused waveform, then return the INTENSITY control to the minimum position. The composite stored waveform should consist of the calibrator waveform with widened portions produced by the 1-kc modulation (see Fig. 2-6c).
7. At the end of the demonstration, remove the modulation signal and connect the ground strap to the EXT CRT CATHODE binding post. Set the CRT CATHODE SELECTOR switch to EXT CRT CATHODE position.
8. Remove the calibrator signal and set the DISPLAY switches to NON STORE.

DISPLAY PHOTOGRAPHY

A permanent record of the crt display may be obtained through the use of a trace-recording camera. When the Type 564 Oscilloscope is operated in non-store mode, trace photography is accomplished in essentially the same manner as with a conventional oscilloscope. Use a normal trace inten-

sity and set the graticule illumination so that it is approximately two-thirds as bright as the trace. See the instructions accompanying the camera for specific techniques.

When the oscilloscope is operated in storage mode, the display may be stored and erased as many times as is necessary to obtain the desired display characteristics before a picture is taken. For non-repetitive waveforms and certain other applications, the ability to compose the display in advance permits the saving of a considerable quantity of film.

Due to the presence of a background glow on the storage screens, special care must be taken in the exposure times and f-stop settings that are used. Of course, these will depend on the type of film used. The graticule illumination should be set to a level slightly less bright than the stored waveform. The trace-to-background contrast in the developed picture is generally improved by allowing the film to overdevelop slightly.

Most of the pictures of storage-mode displays shown in this manual were taken on ASA3000 medium-contrast film at about 1/100th second and f5.6. Greater contrast can be obtained with a high-contrast type of film.

SECTION 3

CIRCUIT DESCRIPTION

General Information

The ability of the Type 564 to store crt displays, in addition to presenting them conventionally, is provided through the addition of certain storage elements in the crt and special circuitry to operate those elements. The remainder of the instrument consists of a regulated low-voltage supply circuit, a crt writing-gun circuit and a calibrator circuit. The block diagram in the schematic diagrams section at the rear of this manual shows the functional relationships between the various circuits.

LOW-VOLTAGE SUPPLIES

Transformer T601 has two primary windings. These windings are connected in parallel for 117-volt operation and in series for 234-volt operation. The secondary of T601 has many windings to supply ac and dc voltages for the oscilloscope and plug-in units.

Regulated Dc Voltages

There are four regulated voltages: -12.2 , -100 , $+125$ and $+300$ volts. Each of these supplies uses silicon diode rectifiers followed by a series regulator circuit.

The -100 -, $+125$ - and $+300$ -volt supplies are designed to use the shunt resistors to supply current for different plug-in unit loads. These shunts allow some load current to bypass the series regulator tube. If a plug-in unit requires a large amount of current, a current shunt resistance or shorting strap is installed in the plug-in unit so that it is connected around the regulator tube when the unit is plugged into the oscilloscope. The plug-in portion of the shunt is always in series with a 2-kilohm ($1/2$ of a center-tapped 4-kilohm) resistor located in the power supply.

-100 -Volt Supply

Reference voltage for the -100 -volt supply is established by gas diode V609. The constant voltage drop across V609 establishes a fixed voltage of about -80 volts at the grid of V634B. Voltage at the grid of V634A is established by divider R616, R617 and R618. The voltage difference between the two grids of V634 sets the plate current of V634A. Plate current of V634A determines the base voltage of transistor Q624 which, in turn, determines the grid voltage of series tube V627. The series tube plate resistance changes to hold the load voltage constant. R616 (-100 VOLTS) determines the percentage of the total divider voltage applied to the grid of V634A and thus controls the output voltage. When this control is properly adjusted, the output is exactly -100 volts.

If the output voltage tends to change because of a change in input voltage or change in load current, the voltage at the grid of V634A will change a proportional amount. Any change at this grid is amplified by V634A and Q624 and applied to the grid of V627. The resulting grid change of

V627 will cause its plate resistance to change in the direction that will bring the output back to -100 volts. C616 improves the response of the regulator to sudden changes in output voltage. R628 is part of the series-tube shunt, connected by some plug-in units.

$+125$ -Volt Supply

The -100 -volt supply serves as a reference for the $+125$ -volt supply. With the R651 end of divider R650 and R651 fixed at -100 volts, any change in the $+125$ -volt output produces a proportional change at the grid of V654. This change is amplified and applied to the grid of series regulator V667A. The change at the grid of V667A changes its plate resistance to bring the output voltage back to $+125$ volts. R656 ($+125$ VOLTS) sets the percentage of total divider voltage applied to the grid of V654 and permits adjustment of the output voltage. When this control is properly adjusted, the output is exactly $+125$ volts. C650 improves the response of the regulator to sudden changes in output voltage. R666 is part of the series-tube shunt.

$+300$ -Volt Supply

Operation of the $+300$ -volt supply circuit is the same as that of the $+125$ -volt supply, with the -100 -volt supply serving as a reference. To provide the voltage for the $+300$ -volt regulator, rectified voltage from terminals 19 and 20 of transformer T601 is added to the voltage supplying the $+125$ -volt regulator. R676 ($+300$ VOLTS) adjusts the output voltage.

The $+300$ -volt supply also provides an unregulated $+420$ volts for the crt circuit.

B903 and R903, in series between the $+300$ -volt supply and the $+475$ -volt unregulated supply, provide a $+355$ -volt source for use by the storage level network and the LOCATE switch. The $+355$ volts, developed by the constant drop of 55 volts across B903, is regulated by the $+300$ -volt supply.

-12.2 -Volt Supply

Operation of the -12.2 -volt regulating circuit is essentially the same as that of the other regulating circuits, except that transistors are used instead of vacuum tubes. The base of Q734 is fixed near -12 volts by voltage divider R731 and R732 between -100 volts and ground. Any variation of the -12.2 -volt output at the emitter of Q734 is amplified by Q734 and Q744 to change the collector resistance of Q757 which is in series with the load. R730 (-12.2 VOLTS) adjusts the voltage applied to the base of Q734. When this control is properly adjusted, the output is exactly -12.2 volts. F720 protects Q757 in case of an overload on the -12.2 -volt supply.

$+475$ -Volt Supply (Unregulated)

The half-wave rectified voltage from terminals 21 and 22 of T601 is added to the $+300$ -volt supply producing a $+475$ -volt storage system supply. C646 filters the voltage rectified by D646.

CALIBRATOR

The calibrator circuit in the Type 564 produces line-frequency amplitude-calibrated square waves.

The 6.3-volt ac (about 18 volts peak-to-peak) heater waveform is coupled through C876 to the cathode of V884A. The amplified signal at the plate of V884A is coupled to the grid of V884B to turn that tube on and off. Regenerative feedback from the plate of V884B to the grid of V884A speeds up to the switching action and drives V884A into and out of cutoff.

The voltage present at the cathode of V884B during the time V884B is conducting is adjusted with R871 (CAL AMPL) to exactly 100 volts. The voltage divider in the cathode circuit of V884B contains precision resistors to provide an output accuracy of at least 3% at the various settings of the CALIBRATOR switch, with high impedance connected to the output.

When the CALIBRATOR switch is set to the .5 VOLTS position and the CAL OUT connector is terminated in 50 ohms, the output amplitude is 0.1 volt.

DEFLECTION CIRCUITS

Push-pull horizontal and vertical signals for deflecting the writing-gun beam are received through pins 17 and 21 of each plug-in unit and applied to the respective deflection plates of the crt. The effective deflection circuit capacitance encountered by each of these signals at the plug-in connector affects the bandpass and phase shift of the plug-in unit. Compensating capacitors C760 and C761 (shown on the Interconnecting Sockets diagram) are factory-adjusted to set the effective capacitance at a standard value of 14.3 picofarads.

CRT (WRITING-GUN) CIRCUIT

The crt circuit contains the cathode-ray tube writing-gun high-voltage supply and the writing-gun control circuit.

Writing-Gun High Voltage

The accelerating potential applied to the writing-gun beam is approximately 3500 volts, developed by the -3300 volts at the writing-gun cathode and the $+200$ volts average potential at the deflection structure and storage target. With this accelerating potential the nominal vertical and horizontal deflection factors are approximately 19.5 and 18.5 volts per centimeter respectively.

A Hartley oscillator, consisting of V800, the primary of T801 and the capacitance of the circuit, provides energy for the high-voltage rectifiers through T801. The oscillator circuit operates at a frequency of about 45 kc.

The output of one secondary winding of T801 is rectified by V822, providing negative voltage for the writing-gun cathode and the focus anode. This voltage is -3300 volts at the cathode and ranges from approximately -2000 to -3000 volts at the focusing element, depending on the setting of the FOCUS control (R844). The 6.3-volt writing-gun heater is also elevated to the cathode potential through R851.

The output of the other secondary winding of T801 is rectified by V832 for the writing-gun control grid. The grid voltage ranges from about -3300 volts to about -3450 volts, depending on the INTENSITY control setting and any intensification signals received from the time-base plug-in unit (delayed sweep only). Reference to ground for this supply is set by the voltage at the junction of diodes D838 and D839. Thus, the voltage at this junction and the INTENSITY control setting determine the writing-gun bias and therefore the intensity of the beam.

Neon bulbs B856 and B857 limit the writing-gun grid-to-cathode voltage to less than 200 volts, for protection of the crt electrodes. Normally the bulbs are not conducting. If the potential difference between the grid and cathode reaches 200 volts, the neons conduct and hold a constant 120 volts until the applied voltages return to normal.

Regulation of the -3300 -volt supply is accomplished by feedback through R841 (HIGH VOLTAGE). If, due to loading or a change in input voltage, the output of the -3300 -volt supply changes, a proportional change is applied through R841 to the grid of V814B. This change is amplified by V814 and coupled to the screen of V800 where it decreases or increases the amplitude of oscillations through V800, thus changing the output of T801 in the direction that will return the high voltage to the correct level. R841 is adjusted to set the bias on V814B for the correct output voltage.

Writing-Beam (CRT) Controls

INTENSITY control R833 adjusts the intensity of the display by varying the writing-gun bias over a range of 0 to -150 volts, relative to the cathode voltage.

FOCUS control R844 and ASTIGMATISM control R864 are operated in conjunction with each other to adjust the writing-beam focus. The FOCUS control varies the focusing anode voltage over the range from -2000 to -3000 volts. The ASTIGMATISM control adjusts the astigmatism anode voltage over the range from 0 to $+300$ volts.

TRACE ALIGNMENT control R860 adjusts the dc current through beam-rotation coil L860 to align the display with the crt graticule.

LOCATE button SW868 locates the vertical position of the display (while the sweep is held off) by applying a positive deflection voltage to the left horizontal deflection plate and unblanking the writing beam. Thus, when the LOCATE button is pressed with the INTENSITY control set for normal brightness, a dot or line will appear to the left of the screen at the display level of the trace or applied vertical signal.

Blanking

The writing-gun beam in the Type 564 is blanked by a special set of deflection plates in the crt. One of the plates (pin 7) is connected directly to the $+125$ -volt supply through R868, R867 and switch SW868 (LOCATE pushbutton). The second plate (pin 5) is connected through the Type 564 to the horizontal plug-in unit. When there is no sweep, a quiescent voltage level of approximately $+20$ volts is applied from the horizontal unit. The potential difference of 105 volts between the two plates deflects the writing-gun beam so that it is absorbed in the deflection structure and does not reach the screen.

The writing-gun beam is unblanked whenever the two deflection plate voltages become equal. If a sweep occurs, if the LOCATE button is pressed, or if the horizontal plug-in unit is removed, the voltages are made equal and the beam is allowed to pass through to the crt screen. Sweep unblanking is produced by a +125-volt gate pulse applied to pin 5, equaling the +125 volts normally present at pin 7. Beam unblanking when the LOCATE button is pressed is accomplished by disconnecting pin 7 from the +125-volt supply. The voltage applied through R869 then equalizes the two plates at the voltage received from the horizontal plug-in unit. (The LOCATE button also causes the beam to be deflected to the left edge of the screen by connecting the left horizontal deflection plate to +355 volts.) When no horizontal plug-in unit is in the Type 564, the beam is unblanked, since the deflection voltage source from the plug-in unit is disconnected from pin 5. In this case, the voltage applied through R869 equalizes the two plates at +125 volts.

Intensity Modulation

The intensity of the writing-beam display may be modulated by applying signals to either the grid or the cathode of the writing gun.

Intensifying signals from a delayed sweep time-base plug-in unit are applied to the grid supply through pin 14 of the horizontal plug-in interconnecting socket. When the overall display intensity is reduced by the time-base unit (set to Intensified), positive intensifying pulses brighten the delayed-sweep portion of the delaying-sweep display. During the time that the beam is not brightened, the writing-gun grid-supply return path is through D839 to a negative voltage; in the intensifying circuit of the plug-in unit. At this time, D838 is reverse biased by the negative voltage at the junction of the two diodes. Intensification results when the positive pulse from the time-base unit turns D839 off and the grid-supply

return path is through D838 (as for normal sweep operation). R837 and C837 then couple the intensifying pulse directly to the crt grid. Thus the brightened portion of the delaying sweep display is the same intensity as a normal display and the background trace is dimmed.

External modulating signals may also be applied to the writing-gun by way of the cathode, through the rear-panel EXT CRT CATHODE connector. With the INTENSITY control adjusted properly, a positive or negative pulse between 3 and 50 volts in amplitude will produce dimming or intensification of the writing beam.

STORAGE CIRCUIT

The storage circuit is made up of the storage portions of the crt, two operating-level cathode followers, a trace enhancement circuit*, an INTEGRATE switch and several dividers that set the storage electrode voltages.

Storage Tube

The storage cathode-ray tube contains certain special storage elements in addition to the conventional writing-gun elements. The operating mode of the tube depends primarily on the voltages applied to the storage elements. With one set of voltages applied, the storage screen operates in storage mode and is able to store waveform displays. With a different set of voltages applied, the screen operates in non-store mode and presents a display similar to that of a conventional oscilloscope.

The storage elements of the crt consist essentially of the flood guns, the collimation electrodes and the storage screens. The flood guns are a high-current source of low-velocity electrons that flood the storage screens, producing

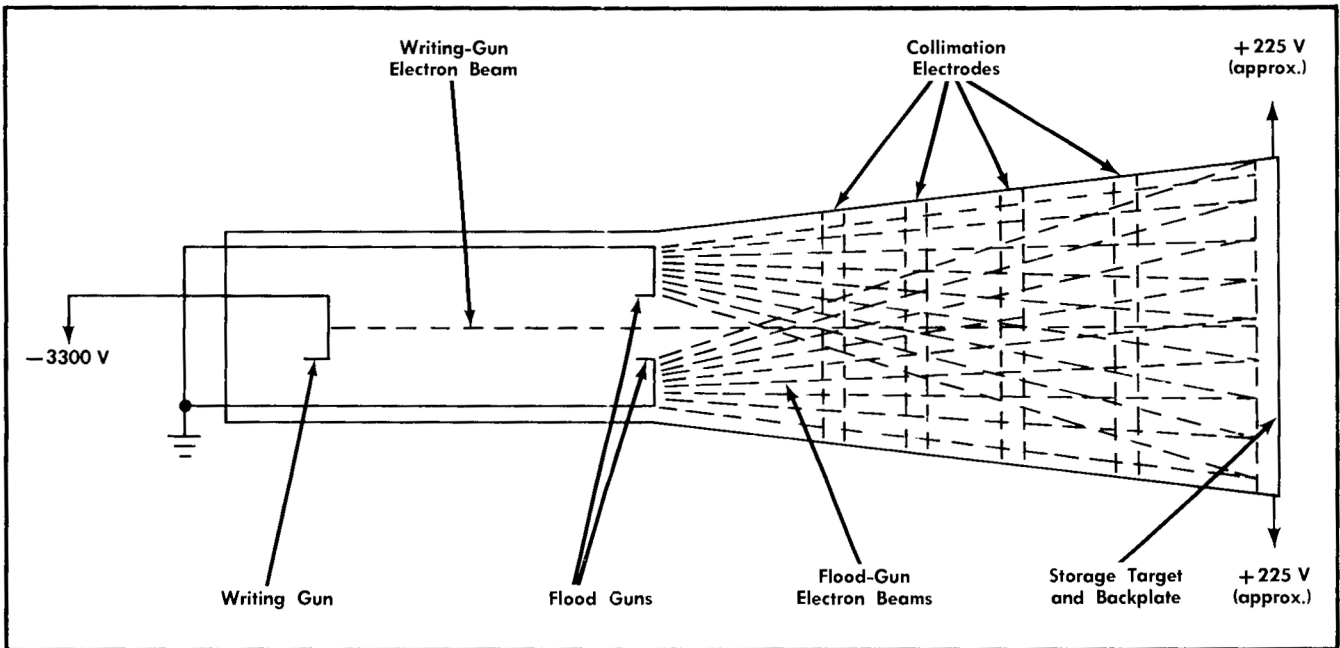

Fig. 3-1. Simplified cathode-ray storage tube operation in storage mode. Deflection and control elements are not shown. (In the non-store mode, storage-target voltage is approximately +120 volts.)

Circuit Description—Type 564

a slight background illumination whenever the instrument is operated in storage mode. The collimation electrodes direct and shape the flood-gun electron beams so they are distributed evenly over the screens. The storage screens are specially-constructed surfaces that are able to continue displaying light information after being bombarded by the writing-gun beam, when activated by the flood-gun electrons. The two screens are electrically isolated and can be operated independently of each other, either in storage or non-storage mode.

Operating Level CFs

Constant voltage sources for the upper and lower storage-target backplates are provided by operating-level cathode followers V913A and V913B. The voltage that is applied through the tube depends on the position of the DISPLAY switch in the grid circuit (SW910 for the upper screen and SW911 for the lower screen). When the DISPLAY switch is set to NON STORE, a voltage of approximately +120 volts is applied from R906 (NON STORAGE LEVEL) through the corresponding cathode follower to the backplate of the screen. At this voltage level, storage of the writing-gun display will not occur.

When the DISPLAY switch is set to STORE, approximately +225 volts is applied from R904 (STORAGE LEVEL) through the cathode follower to the storage-target backplate (see Fig. 3-1). Sufficient flood-gun current is drawn to raise the phosphor energy to a level slightly below the point of producing secondary-electron emission. Any of the phosphors that are then raised above the secondary-emission threshold by additional energy received from the writing-gun beam are held in a high-energy state by the flood-gun current and continue to emit light. The phosphors that continue to glow after the writing beam has passed produce the stored image on the screen.

As the screen becomes increasingly written (stored), its backplate current increases, but the backplate voltage is held constant by the operating-level cathode follower.

When the DISPLAY switch is pressed to ERASE, a higher positive voltage pulse (approximately +250 volts) is applied to the backplate, raising all the phosphors above the secondary-emission threshold. Then, when the switch is released and returns to STORE position, a negative pulse (applied through C916 or C918 and the cathode follower) drives the energy level of the screen below the secondary-emission threshold. This erases the stored image and returns the screen to its "ready" condition, able to store the next image produced by the writing beam.

As the storage-target backplate voltages are changed by the DISPLAY switch, the collimation electrode voltages are also changed to keep the flood-gun electrons uniformly distributed over the screen. The voltages applied to the collimation electrodes are adjusted by R930 (COVERAGE 1) and R938 (COVERAGE 2). The voltage applied to the flood-gun anode and the first two collimation grids is adjusted to approximately +180 volts by R940 (GEOMETRY). This control also sets the voltage on the deflection-plate isolation shield.

Integrate Switch

When the INTEGRATE pushbutton switch (SW948) is in its normal position, the flood guns are held at ground level

by the path through L948, SW948 and D948*. With the DISPLAY switch at STORE, pressing the INTEGRATE button disconnects the flood guns from ground and cuts off the flood-gun current. As current cuts off, the cathode voltage rises to about +55 volts due to continued electron emission. The background illumination of the screens caused by the flood-gun current ceases, though the storage-target backplate voltage is still at the storage operating level.

If the writing gun is displaying a repetitive waveform on the storage screen at this time, its beam is allowed to trace several times over the same phosphors. When the INTEGRATE button is released, the flood-gun current is restored and any phosphors that have been raised above the secondary-emission energy threshold by the writing-gun beam during flood-gun cutoff then emit light at the normal stored light level.

When the INTEGRATE button is pressed, it also adjusts the high-voltage supply slightly to correct for the deflection change as the flood guns are turned off, by connecting the high-voltage divider to ground through R948 and R848 (in the crt circuit).

If the WRITING RATE INCREASE switch* is on when the INTEGRATE button is pressed, the negative pulse produced as the button is released (connecting the flood guns to ground) is applied through R949 to the trace-enhancement circuit.

R944 (B FLOOD GUN BIAS) and R946 (A FLOOD GUN BIAS) are adjusted to set the flood-gun grid voltages at approximately -50 volts for maximum uniform flooding of the storage screens.

Trace-Enhancement Circuit (S/N 2000-up)

A negative-going pulse is applied to the base of Q975 from the time-base dual-trace sync output through pin 4 of the horizontal interconnecting jack, R970, C970 and D972, or from the INTEGRATE switch circuit through R949, C949 and D971. In single-sweep mode, a single pulse is applied from the time-base unit at the start of the sweep. (The trace-enhancement circuit is not ordinarily used for repetitive sweeps.) D971 and D972 are both normally reverse biased due to current from the -100-volt supply to ground through the base-emitter junction of Q975 and the WRITING RATE INCREASE control. If the WRITING RATE INCREASE switch (SW977) is turned off, the negative pulse has no effect on the circuit, since Q975 is inoperative.

If the WRITING RATE INCREASE switch is turned on (pulled out), the collector of Q975 is connected to ground and the transistor is conducting. Q985 is still turned off at that time. A negative pulse applied to the base then cuts off Q975, causing Q985 to turn on. The large negative output pulse that occurs when Q985 turns on is applied to the pulse amplitude network, to the base of Q975 through C985 and R979, and to ground through R978 and R977 (WRITING RATE INCREASE control). The regenerative feedback to the base prolongs the duration of the output pulse for a length of time determined by the time constant of C985, and the resistance in the base circuit of Q975. This time constant, and thus the pulse width, is adjusted by R977 (WRITING RATE INCREASE). As soon as the pulse has passed, the circuit returns to a "ready" condition, to be activated by the next negative pulse.

*Trace-enhancement circuit and WRITING RATE INCREASE control added at S/N 2000.

The output pulse of approximately -40 volts at the center arm of R984 (PULSE AMPL) is applied to the flood-gun cathodes through SW948 and L948 and to the flood-gun grids through C945 and C947. By increasing the potential difference between the flood guns and the storage screens during a single sweep of the trace, the negative pulse from the trace-enhancement circuit raises the energy level of the phosphors to a point very near the secondary-emission threshold, for the duration of the enhancement pulse. While

the phosphors are held so close to the threshold, less energy is required from the writing beam electrons and the effective writing speed is increased, allowing very fast single sweeps to be stored.

The negative pulse from the INTEGRATE switch as the button is released provides a means of activating the trace-enhancement circuit while the sweep is held off or when the instrument is operated in X-Y mode.

SECTION 4

MAINTENANCE

PREVENTIVE MAINTENANCE

The Type 564 Oscilloscope is a precision instrument and therefore requires and deserves adequate care. If the instrument is serviced and recalibrated at regular intervals it will provide a long life of reliable and accurate service.

Periodic Inspection and Recalibration

The Type 564 should be serviced and recalibrated after each 500 hours of operation or more frequently if operated under adverse conditions such as a dusty atmosphere or high temperature. Even if the instrument is used only occasionally, it should be serviced and recalibrated at least once every 6 months. Servicing and troubleshooting suggestions are given in this section of the manual. See the Calibration section for calibration procedures.

Whenever the instrument is repaired or recalibrated, a visual check should be made of the controls and circuitry. Certain types of trouble can be detected by a visual inspection. Look for such obvious defects at control knobs out of alignment, damaged connectors, loose or broken solder connections, improperly seated tubes or transistors, broken terminal strips and scorched parts. Most of these troubles can be corrected by obvious means. In the case of heat-damaged parts, however, the damage is often the result of less apparent trouble. In order to prevent further damage, the cause of the overheating should be located and corrected before attempting to operate the instrument.

We advise against routine replacement of electron tubes or transistors during periodic servicing. Since each tube or transistor has its own individual operating characteristics, any circuit that has one of these components replaced or exchanged will require a calibration check. If tubes or transistors are to be removed temporarily during servicing, they should be marked with their circuit numbers to be sure they will be returned to their original sockets. Each circuit number is marked on the chassis next to the socket.

Removal of Panels

The side panels of the Type 564 Oscilloscope can be easily removed for access to the internal circuitry. The panels are held in place by small screwhead fasteners that can be released with a broad-blade screwdriver or a small coin. Turn each fastener about two turns counterclockwise to free the panels. For normal operation, the panels should be left on the instrument to keep dust out.

Cleaning the Exterior

Dirt can be removed from the cabinet exterior with a soft cloth dampened with a water solution of soap or detergent. Abrasive cleaners should not be used. A dry paint brush may be useful for removing dust from front-panel control knobs.

The glass face of the crt and the plastic graticule can be cleaned with a water solution of soap or detergent or with a simple non-denatured alcohol such as isopropanol.

CAUTION

Do not clean any plastic materials with organic chemical solvents such as benzene, acetone or denatured alcohol. These solvents might damage the plastics.

Cleaning the Interior

The side panels of the instrument keep the interior relatively clean, but normal air circulation brings in a small amount of dust. To avoid building up a heavy accumulation, this dust should be blown out with a low-velocity stream of compressed air during periodic servicing. (Avoid the use of a high-velocity air stream that might damage small components.) Persistent dirt can be removed with a damp cloth or small paint brush. A cotton-tipped applicator dampened with isopropanol can be used for cleaning narrow spaces and ceramic strips.

CORRECTIVE MAINTENANCE

If apparent trouble develops in the Type 564 Oscilloscope, first check the settings of all front-panel controls to make sure the instrument malfunction is not the result of some control misadjustment. Review the Operating Instructions if you are not completely familiar with the operation of the instrument. If an external signal is being applied, check the input cable or probe to be sure the signal is reaching the vertical input.

If all front-panel control settings and input connections are found to be correct for the desired mode of operation but the instrument does not operate properly, either there is trouble in the circuitry, or else some part of the system is out of calibration. Check the calibration of any suspected circuit before attempting to troubleshoot the instrument. A complete calibration procedure is given in the Calibration section of this manual. Troubleshooting procedures and suggestions are given later in this section.

Ordering Replacement Parts

If you have established through operational or troubleshooting checks that an electrical or mechanical part requires replacement, the following information may aid you in ordering and replacing the part.

Replacements for all parts used in the Type 564 can be purchased directly through Tektronix. Many of the electrical parts can also be obtained from local electronics suppliers. Certain critical electrical parts and nearly all mechanical parts are normally not available from other sources and should be ordered from Tektronix. Consult the Parts List in this manual for the required characteristics before ordering or purchasing any part.

When ordering through your local Tektronix Field Office, be sure to include the following information:

1. The complete description of the part as given in the Parts List.

Maintenance—Type 564

2. The instrument type (Type 564).
3. The instrument Serial Number.

If a part that is ordered has been superseded by a newer part, the new part will normally be shipped instead of the part ordered.

Replacement Procedures

In general, the replacement of most parts in the Type 564 Oscilloscope is simple and straightforward—just remove the defective part and install the replacement. Certain parts, however, require special care or special procedures during replacement. The following subsections contain supplementary information and some practical hints that may aid you when performing corrective maintenance on the instrument.

Be sure to install replacement components in the exact positions occupied by the original parts. The presence of normal stray fields and capacitance within the instrument makes the positioning of some components important to the operation of the system.

Ceramic Strip Soldering

Many of the components in your Tektronix instruments are mounted on ceramic terminal strips. The notches in these strips are lined with a silver alloy. Application of excessive heat or repeated use of ordinary 60-40 tin-lead solder will break the silver-to-ceramic bond. Occasional use of ordinary solder is permissible, but for general repair work on Tektronix instruments solder containing about 3% silver should be used. Silver-bearing solder is available locally from electronics distributors or may be purchased in 1-pound rolls through your Tektronix Field Office. Order by Tektronix part number 251-514.

When removing or installing a part mounted on ceramic terminal strips:

1. Use a 50-watt to 75-watt soldering iron with a thin wedge-shaped tip.
2. Tin the tip of the iron with silver-bearing solder

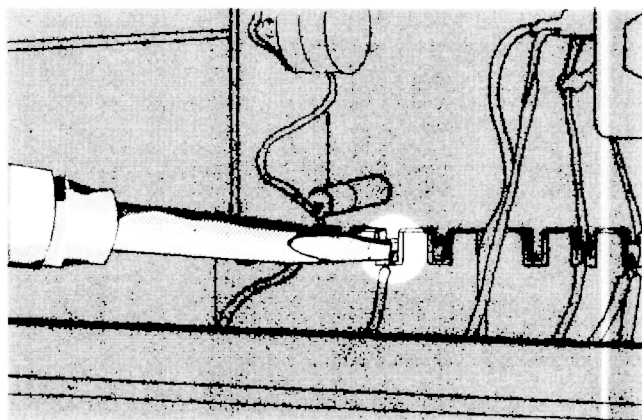

Fig. 4-1. Correct method of applying heat when soldering on a ceramic terminal strip.

3. Apply heat by touching one corner of the soldering iron tip to the base of the notch. See Fig. 4-1. (Do not force the tip of the iron into the terminal notch, as this may chip or break the ceramic strip.)

4. Use the minimum amount of heat required to make the solder flow freely.

5. Apply only enough solder to form a good bond. Do not attempt to fill the notch with solder.

Other Soldering Considerations

When soldering to a rotary switch, do not let the solder flow around and beyond the rivet on the switch terminal. The spring tension of the switch contact may be destroyed by excess solder and the switch will need to be replaced.

When soldering or unsoldering any short lead or small component, observe the following precautions:

1. Use long-nose pliers to act as a heat shunt between the soldering point and the component. See Fig. 4-2.
2. Use a moderately hot iron for a short period of time.
3. Manipulate your tools with care to avoid damage to small components.

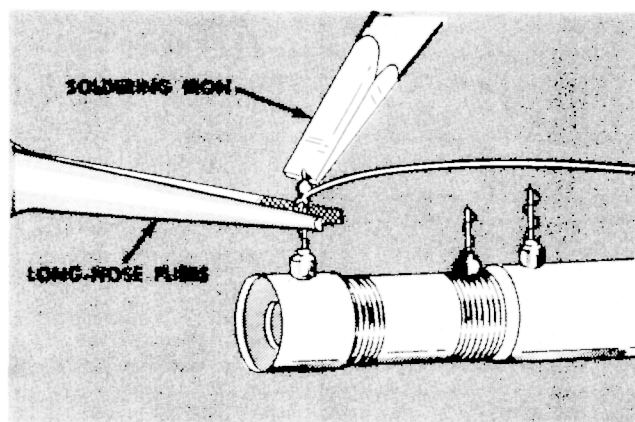

Fig. 4-2. Use long-nose pliers to absorb excess heat when soldering to small or short-lead components.

If it is necessary to hold a bare wire in place while soldering, a handy tool for this purpose can be made by tapering a 1/4-inch wooden dowel or thermoset plastic rod into a wedge shape at one end.

After soldering any connection, clip off the excess length of the soldered leads. Be sure that these ends are not dropped into the instrument where they could cause electrical shorting.

Ceramic Strip Replacement

To replace a damaged ceramic terminal strip, first unsolder all connections, then pry the mounting studs out of the chassis. The strips may also be removed by tapping the studs out from the reverse side of the chassis or by cutting off one side of each stud with diagonal cutters.

If the nylon spacers do not come out with the studs, they may be left in the chassis or pulled out separately. If undamaged, the spacers can be used with the new ceramic strip assembly. Since mounting studs are attached to replacement ceramic strips, it is not necessary to salvage the old studs.

When the damaged strip assembly has been removed, place the spacers into the mounting holes in the chassis and press the mounting studs of the new assembly into the spacers. It may be necessary to tap lightly to make the studs seat all the way down on the spacers. To avoid damage to the terminal strip, use a soft-tipped tool for tapping and apply the force directly above the mounting studs. Fig. 4-3 shows the assembled terminal strip.

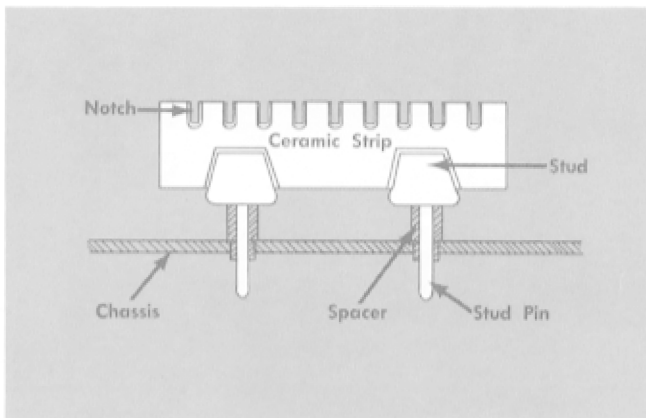

Fig. 4-3. The assembled ceramic terminal strip.

Cut off the excess length of the mounting studs extending beyond the ends of the spacers on the reverse side of the chassis. Resolder all components and wires in place (see "Ceramic Strip Soldering" suggestions given above).

Power Transformer Replacement

If a complete check of the instrument shows that the power transformer requires replacement, notify your local Tektronix Field Office. The Tektronix Field Engineer will verify the transformer failure for a warranty replacement. (See the Warranty note in the front of this manual.)

TABLE 4-1

Power Supply Resistance Checks

(Power line disconnected, plug-in units removed)

Supply (See Fig. 4-4)	Approximate Resistance
Primary	infinite
-100 volts regulated	4 k to 13 k
+125	6 k to 22 k
+300	10 k to 38 k
-12.2	5 Ω* to 19 Ω*
+420 volts unregulated	20 k to 80 k
+475	17 k to 66 k

*Positive lead connected to ground.

Be sure to use only the correct replacement for a power transformer. Tag the leads with the terminal numbers as they are unsoldered from the transformer to aid in connecting the new transformer. After replacing the power transformer, check the power supply (to ground) resistances given in Table 4-1, then check the calibration of the entire instrument.

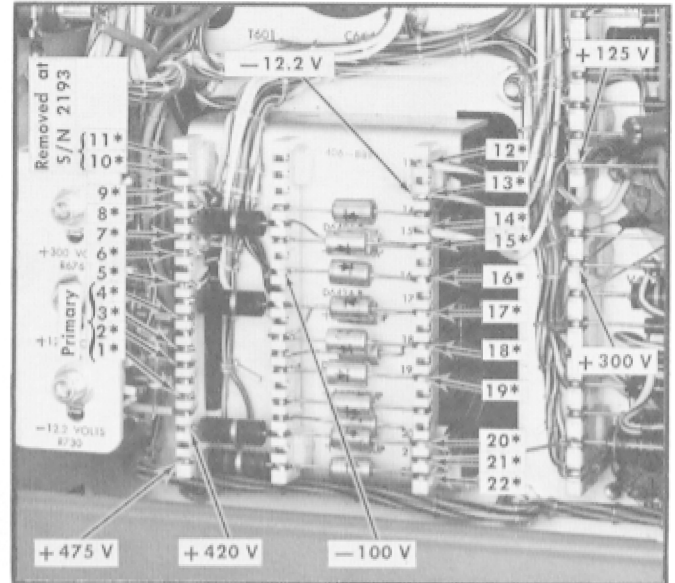

Fig. 4-4 Power transformer (T601) terminal connections (indicated by *) and power-supply resistance test points. See "Transformer Conversion" portion of Operating Instructions for transformer primary wiring.

Replacement of Rotary Switches

When a rotary switch is removed, tag the leads and the switch contacts with corresponding identification tags, then use the old switch as a model for wiring the new one. The entire switch should be replaced if one section is defective. Order the switch either with or without associated components wired in place. The appropriate part numbers are given in the Parts List.

Crt Replacement

WARNING

When replacing the crt, wear goggles and heavy gloves for protection in case of an implosion.

To remove the cathode-ray tube, first disconnect the deflection-plate leads at the neck of the tube, then remove the base socket and loosen the clamp at the base of the tube. Be careful not to bend the neck pins. (Do not disconnect the trace-alignment coil or collimation-electrode leads on the bottom of the crt shield.) Remove the graticule cover and the reflector shield and holder. Pull the crt straight out through the front panel, being careful not to bend the crt neck pins or collimation-electrode contacts. The graticule and rubber shockmount ring can be removed from the crt after it is out of the instrument.

Install the new crt by reversing the above procedure. Place the rubber shockmount ring on the crt before insertion.

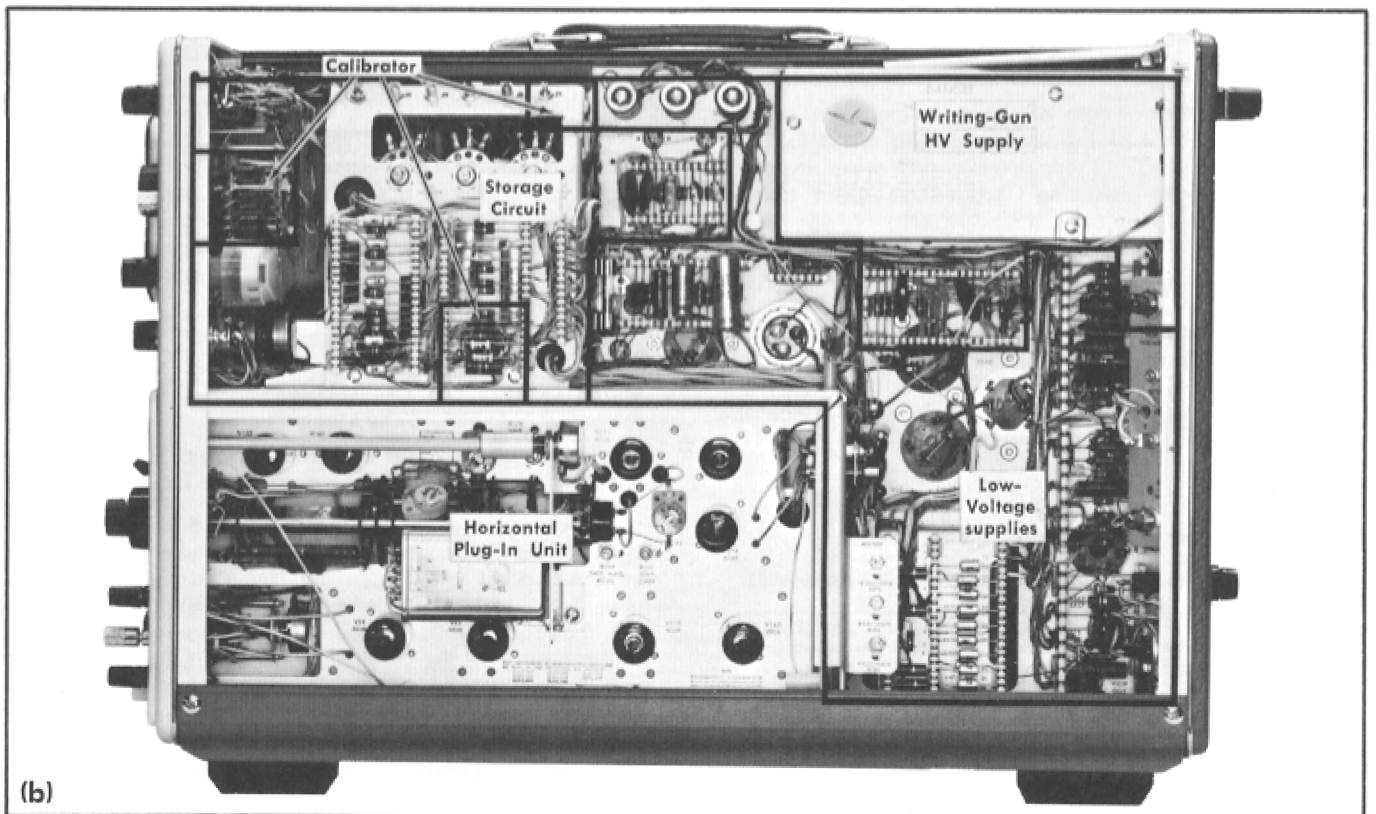
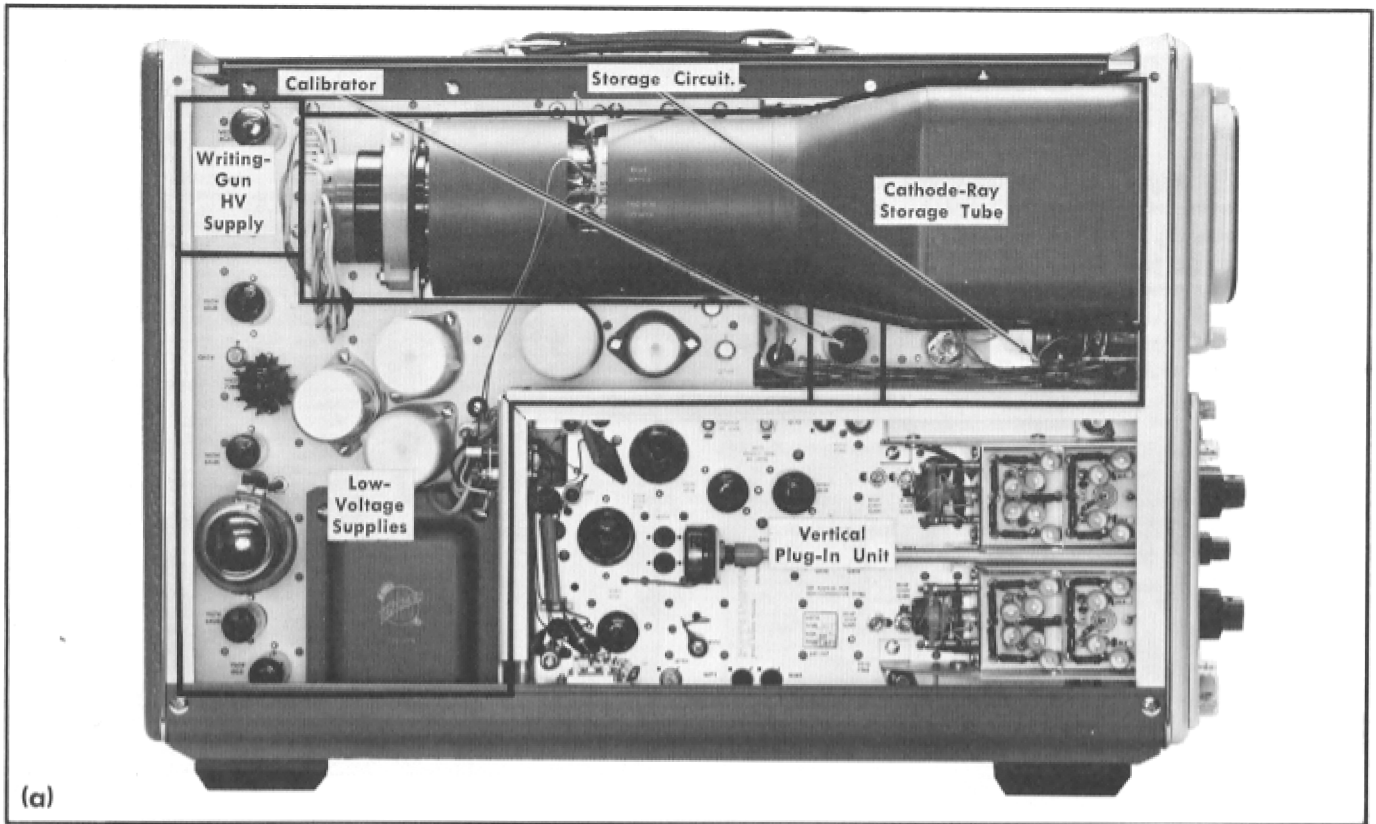

Fig. 4-5. Locations of basic circuits in the Type 564: (a) left-side view; (b) right-side view.

When the crt is properly installed, the tabs on the rubber ring fit against the front panel of the instrument. Tighten the crt base clamp securely. The color-code information on the crt shield indicates the order in which the neck-pin leads are to be connected. Insert the graticule in the rubber ring, with the graticule markings on the surface next to the crt faceplate. Align the horizontal centerline with the separation line between storage screens before replacing the graticule cover.

After replacement of the crt, it will be necessary to recalibrate all circuits except the low-voltage power supplies. Refer to the Calibration section of this manual.

Recalibration After Repair

After any electrical component has been replaced, the calibration of that particular circuit should be checked, as well as the calibration of other closely related circuits. Since the low-voltage supplies affect all circuits, calibration of the entire instrument should be checked if work has been done in the low-voltage supplies or if the power transformer has been replaced.

TROUBLESHOOTING

This portion of the Maintenance section contains information intended to aid in locating and correcting any apparent trouble that may occur in the instrument. Familiarity with normal operation can be of great assistance in locating trouble. This familiarity can be gained through the use of this instruction manual and through actual use of the instrument. The following procedure may be used for finding and correcting most troubles:

1. Confirm that a trouble exists.

Incorrect control settings may appear to indicate the presence of trouble. Check first to make sure the front-panel controls are set properly for the desired mode of operation. For example, an incorrect setting of the Sweep Mode switch or Triggering Source switch on the time-base unit can indicate apparent sweep trouble; an uncalibrated Variable control on an amplifier unit can indicate an apparent decrease in sensitivity.

2. Isolate the trouble to a unit.

Trouble can be isolated to the Type 564, the vertical unit or the horizontal unit in one of two ways, depending on the availability of spare plug-in units:

If a spare vertical unit and a spare horizontal unit are available, substitute the spare units, one at a time, for the units in the Type 564 plug-in compartments. If proper operation is restored when one of the units is replaced, that unit was causing the trouble. If substitution of both plug-in units does not restore proper operation, the Type 564 is probably at fault.

NOTE

A sampling-type plug-in unit cannot be operated with a non-sampling plug-in unit.

If no spare plug-in units are available, the following symptoms and checks can be used to isolate the trouble to one of the units. Set the DISPLAY switches to NON STORE and use the minimum display intensity required for each check.

a. No trace or spot can be obtained on the crt screen.

Turn the INTENSITY control fully counterclockwise. Remove both plug-in units, then adjust the INTENSITY control to display a spot on the screen. If no spot appears, the trouble is in the Type 564. If a spot appears, reinsert each unit separately. (Set the time-base unit for a free-running sweep.) After warm up, turn the Position control on the unit. If the spot or trace cannot be approximately centered on the crt screen with only one plug-in unit in the Type 564, the trouble is probably in that plug-in unit.

b. Deflection is insufficient and timing is incorrect.

Check the voltage supplies at the low-voltage and high-voltage test points given in the calibration procedure. If incorrect, remove one plug-in unit and recheck the voltages. Reinsert the one plug-in unit, remove the other unit and check the voltages again. If the power supply voltages became correct when either of the plug-in units was removed, the trouble is in that unit. If, however, the voltages are still incorrect regardless of which plug-in unit is removed, the trouble is in the Type 564.

c. Triggering is incorrect.

Check triggering from internal, line and external sources. If the line and external triggering operate correctly but internal triggering does not, the trouble is probably in the Trigger Pickoff circuit of the amplifier plug-in unit. If none of the sources provide satisfactory triggering, the trouble is probably in the time-base unit.

d. Waveform is distorted.

Check the sweep timing. If timing is correct, the trouble is probably in the vertical amplifier plug-in unit. If the timing is incorrect, check the voltage supplies as in step b above.

If the trouble was found to be in either of the plug-in units, check the defective unit according to the procedure given in the instruction manual for that unit. As an aid in troubleshooting a plug-in unit, either of the units may be operated outside of the Type 564 by extending it from the oscilloscope with special extension cable (Tektronix part number 012-066), available through your local Tektronix Field Office.

3. Isolate the trouble to a circuit.

The source of any trouble in the Type 564 will usually be obvious from the apparent symptoms. The normal or abnormal operation of controls will also help to locate the source of trouble. There are four basic circuits in the instrument: the low-voltage power supplies; the crt writing-gun circuit; the storage circuit; and the calibrator. The locations of these basic circuits are shown in Fig. 4-5.

Trouble in the calibrator circuit is obvious if only that circuit is malfunctioning. Trouble in the low-voltage supplies

Maintenance—Type 564

can be quickly detected by measuring the output voltages and by checking regulation and ripple as described in the calibration procedure.

NOTE

Do not adjust any of the voltage supplies unless the particular voltage is out of tolerance. Any adjustment or replacement of parts in the low-voltage supplies will necessitate a calibration check of the entire instrument.

If these supplies are all within tolerance, the trouble is either in the crt writing-gun circuit or the storage circuit. Check the crt writing-gun voltage (−3300 volts) at the high-voltage test point (see calibration procedure). If the crt voltage is correct, operate the DISPLAY (storage) controls and the CRT (writing) controls to determine definitely which of these circuits is causing the trouble.

4. Check tubes and transistors.

Most circuit failures are caused by electron tube or semiconductor failure due to normal aging and use. The recommended method of checking a tube or transistor is by direct substitution, since commercial testers do not indicate the circuit performance of a component. A characteristic curve display instrument, such as a Tektronix Type 570 or Type 575, may also be useful in checking a tube or transistor that is suspected of being defective. Before installing a replacement tube or transistor, be sure that the circuit voltages are approximately normal. If replacement is made without checking the circuit, the new component may be damaged by some defect in the circuit.

Tubes and transistors that are found to operate correctly in the circuits should be returned to their original sockets. Unnecessary replacement or switching of components may require that the instrument be recalibrated.

5. Check circuit calibration.

After a trouble has been confirmed and isolated to a particular circuit, if tube or transistor checks do not locate the trouble, check the calibration of the suspected circuit according to the procedure given in the Calibration section of this manual. The calibration checks can be performed out of sequence after reading the General Information at the first of the section.

6. Troubleshoot the circuit.

If all other checks fail to indicate the precise location of the trouble, the circuit can be checked in detail with a high-impedance voltmeter and a test oscilloscope. Voltages at various points in the instrument are given on the schematic diagrams located at the rear of this manual.

Be careful when checking inside the instrument with meter leads and probe tips. Careless shorting of leads can apply abnormal voltages or transients to the components and cause the destruction of semiconductors or other small components.

Table 4-2 relates certain specific trouble symptoms to their probable causes, and indicates some of the components that might be defective. This table should be used primarily as a guide for troubleshooting, since it does not include all possible troubles that might occur, nor all possible causes for the given symptoms. The schematic diagrams, used in

conjunction with the circuit description, will suggest other checks that can be made.

Troubleshooting Aids

The assigned circuit number of each component in the Type 564 is shown on one of the schematic circuit diagrams. Inside the instrument, the circuit number of each tube, transistor, electrolytic capacitor and internal control is marked on the chassis near the component to provide correlation between the symbols on the diagrams and the components in the instrument.

The sections of the rotary Calibrator switch are coded on the schematic to indicate the physical positions of the switch contacts. The sections are numbered from the front panel to the rear of the assembly. The letters F and R indicate whether the front or the rear of the section is used to perform the particular switching function.

All wiring in the instrument is color-coded for the purpose of circuit tracing. Nearly every signal lead carries one or two colored stripes for identification. The stripes on each regulated voltage-supply lead indicate the approximate voltage carried by the lead, using the standard EIA color code. The stripes are read in order of decreasing width. As an example of the coding used, the +300-volt supply lead is coded orange (widest stripe), black, brown (narrowest stripe).

Component Checking

Components that are soldered in place can usually be checked quickly after unsoldering one end. For example, a capacitor can be checked for leaky or shorted condition by checking its resistance on a megohm scale. The resistance should read infinite as soon as the capacitor is charged. An open capacitor may best be detected with a capacitance meter or by checking the waveform on each side of the component with the circuit in operation.

An open condition in a resistor or inductor can be detected by a ohmmeter continuity check. Shorted or partially shorted inductors can usually be found by analysis of high-frequency signals passing through the circuit. Partial shorting reduces the frequency response (rolloff).

A junction diode can be checked for an open or shorted condition by making an ohmmeter check between terminals. With an ohmmeter scale using an internal source of 1½ volts, the resistance should measure very high in one direction and very low in the other.

CAUTION

Do not use an ohmmeter scale that uses a voltage source greater than approximately 3 volts. A high voltage applied in the reverse direction may exceed the junction breakdown voltage, giving an erroneous reading and possibly damaging the semiconductor being checked.

7. Repair and readjust the circuit.

Refer to the replacement procedures and suggestions given under "Corrective Maintenance" (earlier in this section) when repairing any trouble found in the instrument. Be sure to check the calibration of any circuit that has been repaired or has had tubes or transistors replaced.

TABLE 4-2
Troubleshooting

Low-Voltage Supplies (Any changes in these circuits may change instrument calibration.)					
Symptoms	Checks	−100-volt Supply	+125-volt Supply	+300-volt Supply	−12.2-volt Supply
1. Incorrect output level, ripple or regulation.	<p>A. Check line voltage. (105 to 125 volts or 210 to 250 volts.) Do not attempt to operate instrument on incorrect voltage.</p> <p>B. Check voltage adjustment. Check instrument calibration if setting is changed.</p> <p>C. Check outputs of other supplies for voltage, ripple and regulation.</p> <p>D. Check tubes and transistors by substitution, one at a time. Install good component if substitution corrects trouble. Recalibrate circuit.</p> <p>E. If output is still not corrected, check additional symptoms given below.</p>	<p>−99 to −101 volts; R616 (−100 VOLTS).</p> <p>Check +125 V supply.</p> <p>V609, V634, Q624, V627.</p>	<p>+123.5 to +126.5 volts; R656 (+125 VOLTS).</p> <p>Check −100 V, +300 V supplies.</p> <p>V654, V667.</p>	<p>+297 to +303 volts; R676 (+300 VOLTS).</p> <p>Check −100 V, +125 V supplies.</p> <p>V674, V667.</p>	<p>−12.1 to −12.3 volts; R730 (−12.2 VOLTS).</p> <p>Check −100 V, +125 V, +300 V supplies.</p> <p>Q734, Q744, Q757, F720.</p>
2. Output voltage too high or too low.	<p>A. Perform checks 1A, 1C and 1D.</p> <p>B. Check ac voltage between terminals on power transformer T601. (Voltages on schematic; terminals shown in Fig. 4-4.) If incorrect, check transformer primary.</p> <p>C. Check voltage at rectifier output. (Voltages on schematic.) If incorrect, check rectifier diodes, electrolytic capacitors, series resistors.</p> <p>D. Check input voltages to error amplifier. (Voltages on schematic.) If incorrect, check resistors, potentiometers and capacitors in divider circuits.</p> <p>E. Check feedback components.</p>	<p>Terminals 15 and 16.</p> <p>Check D640, C640A, C640B, R640.</p> <p>Pins 7 and 2, V634.</p> <p>C616, R635.</p>	<p>Terminals 17 and 18.</p> <p>Check D642, C642A, C642B, R642.</p> <p>Pins 1 and 6, V654.</p> <p>C650, R650.</p>	<p>Terminals 19 and 20.</p> <p>Check D644, C644, C667, R644.</p> <p>Pins 1 and 6, V674.</p> <p>C670, R670.</p>	<p>Terminals 12 and 13, 13 and 14.</p> <p>Check D720, D721, C720, C757.</p> <p>Base, Q734.</p> <p>R744, R737, C737.</p>
3. Poor regulation ($\pm 2\%$ tolerance).	<p>A. Perform checks 1B, 1C and 1D.</p> <p>B. Check voltage at plate (or emitter) of series regulator. (Voltages on schematic.) If incorrect, substitute other plug-in units, check output resistor, check shunt resistors in plug-in units.</p>	<p>Pin 3, V627. Check R628.</p>	<p>Pin 2, V667. Check R666.</p>	<p>Pin 5, V667. Check R667.</p>	<p>Emitter Q757.</p>

Low-Voltage Supplies (Cont'd)					
Symptoms	Checks	-100-volt Supply	+125-volt Supply	+300-volt Supply	-12.2-volt Supply
4. Excessive ripple.	A. Perform checks 1A, 1B, 1C, 1D and 3B. B. Check ripple at plate (or emitter) of series regulator. If excessive, check rectifier and electrolytic capacitor. C. Perform check 2f.	Pin 3, V627; 5 v max. Check D640, C640A.	Pin 2, V667; 8 v max. Check D642, C642A.	Pin 5, V667; 12 v max. Check D644, C644.	Emitter, Q757; 2 v max. Check D720, D721, C720.
Crt (Writing Gun) Circuit					
Symptoms	Checks				
5. Any incorrect operation of writing gun circuit.	Preliminary: Set DISPLAY switches to NON STORE for protection of storage screens. A. Check line voltage and low-voltage supplies. (See checks 1A and 1B). B. Check HIGH VOLTAGE (R841) adjustment. See calibration procedure. C. Check heaters of V822 and V832 for color: dull orange—normal. bright—heavy load on either tube. Check for source of loading. dim—poor tube. Replace and recalibrate high-voltage adjustment. both dark—oscillator or regulator inoperative. D. Check V800 and V814 for heater glow. E. Check V800 and V814 by substitution, one at a time. Install good tube if substitution corrects trouble. Readjust high voltage. F. If operation has still not been corrected, check for additional symptoms as in checks 6 through 13.				
6. No intensity.	A. Check INTENSITY control setting. B. Perform checks 5A through 5E. C. Make sure sweep is not held off by horizontal unit. (Deflection-blanking voltage is applied except during sweep.) D. Make sure spot or trace is not positioned off-screen by vertical or horizontal plug-in unit. With both plug-in units removed and horizontal deflection plates shorted together, spot should appear near center of screen. <p style="text-align: center;">CAUTION</p> When removing plug-in units have DISPLAY switches set to NON STORE, spot defocused and INTENSITY control turned counter-clockwise. Increase intensity slowly to display spot on crt screen. E. Check B856 and B857. If glowing brightly, V822 is probably inoperative. Check voltage at pin 7, V814. (See schematic diagram.) Check C822, C842.				
7. Low intensity.	A. Check INTENSITY control setting. B. Perform checks 5A through 5E. C. Check unblanking waveform at pin 22 of horizontal plug-in connector. Sweep gate signal should alternate between +125 volts (sweep) and about +20 volts (holdoff). D. With power off, check high-voltage divider (R847, R840 through R846).				
8. High intensity.	A. Check INTENSITY control setting. B. Perform checks 5B through 5E. C. With power off, check resistors and capacitors in grid-bias circuit (R831 through R836, C830, C832, C837).				
9. Poor astigmatism and/or focus.	A. Check ASTIGMATISM and FOCUS control settings. B. Perform check 5f. C. Check voltage at pin 8 of crt. Should change from +300 to 0 volts as ASTIGMATISM control is rotated. If incorrect, check R864 and the +300 volts to R864.				
10. Blooming (increase in intensity and display size).	Perform checks 5C, 5D and 5E.				

Crt (Writing Gun) Circuit (Cont'd)	
Symptoms	Checks
11. No intensification of delaying sweep.	In Normal mode, check voltage at junction of D838-D839 for +0.3 to +0.6 volt. May damage delayed-sweep unit if greater than +0.6 volt. Check R838 and D838.
12. No (external) intensity modulation.	Check C853 and R853.
13. Undesired intensity modulation.	A. Make sure ground strap is connected to EXT CRT CATHODE connector. B. Check D838 and D839.
Storage Circuit	
14. Any incorrect operation of storage functions.	Preliminary: Set DISPLAY switches to STORE to establish operating voltages. A. Check upper and lower screen voltages, given on schematic. B. Check V913 by substitution. Install good tube if substitution corrects trouble, then recalibrate storage circuit. C. Check line voltage and low-voltage supplies (checks 1A and 1B). D. Check unregulated +475-volt supply at pin 1, V913. If incorrect, make sure that B903 is lighted. E. Check collimation-electrode voltages, given on schematic. F. Check calibration of storage and non-storage level. (See calibration procedure.) G. If operation is still incorrect, check for additional symptoms as given in steps 15 through 25.
15. Flood guns inoperative.	A. Check voltages at crt pins 6 and 11 and at center (ORANGE) neck pin. (Voltages given on schematic.) B. Check flood-gun heater (pins 10 and 11) for continuity, with power off and base disconnected. C. Perform checks 14A and 14F. D. Check D948, SW948.
16. Screen does not store.	Perform checks 14A and 14F.
17. Screen does not store single-sweep displays.	A. Check INTENSITY control setting. B. Make sure sweep speed does not exceed writing speed (see operating instructions).
18. Screen does not erase.	A. Perform check 14D. B. Check voltage at junction of R937, R938, given on schematic. C. Check D920 (upper screen) or D926 (lower screen).
19. Image cannot be completely erased.	See Crt Precautions given in Operating Instructions section, "Care of Storage Screens".
20. Screen has poor contrast.	A. Perform checks 14A and 14F. B.* Make sure WRITING RATE INCREASE switch is turned off. (If in use, turn control to a lower setting.)
21. Background brightens after storing.	A. Perform check 14F. B. Check collimation-electrode adjustments. (See calibration procedure.)
22. INTEGRATE button changes crt deflection factor.	A. Check R948 and R848. B. Check C849 and D849. C. Check INTEGRATE switch (SW948).
23. INTEGRATE button inoperative.	A. Check voltage at junction of R948, R848. Should be approximately +270 volts normally; approximately +8 volts with INTEGRATE button pressed. B. Check INTEGRATE switch (SW948).
24. LOCATE button does not locate trace.	A. Make sure sweep is held off and INTENSITY control is set slightly below normal (see operating instructions). B. Check B903 and R865. C. Check LOCATE switch (SW868).

Maintenance—Type 564

Storage Circuit (Cont'd)	
Symptoms	Checks
25.* WRITING RATE INCREASE inoperative.	A. Check for sync pulse at pin 4 of horizontal plug-in unit. B. Check pulse at center arm of R984. Pulse should be approximately —40 volts in amplitude and should range in width from 1 to 6 msec as control is rotated throughout its range. C. Check Q975 and Q985 by substitution. D. Check D972 and D973. E. Check WRITING RATE INCREASE switch (SW977).
Calibrator	
26. No output.	A. Check V884 for heater glow. B. Check V884 by substitution. Install good tube if substitution restores proper operation, then recalibrate CAL AMPL adjustment. C. Check for line-frequency waveform at C876. D. Check circuit voltages given on schematic.
27. Incorrect output amplitude.	A. Make sure output is not loaded with low impedance. (Amplitudes are correct only for high-impedance loads.) B. Check CAL AMPL adjustment. (See calibration procedure.) C. Perform checks 26B and 26D. D. Check output divider. (See calibration procedure.)
28. Nonsymmetrical output.	A. Perform checks 26B through 26D. B. Check C879.

*Does not apply below S/N 2000.

SECTION 5

CALIBRATION

General Information

The Type 564 should be serviced and recalibrated after each 500 hours of operation (at least once every 6 months) to insure that it is operating properly and accurately. In addition, certain portions of the instrument must be recalibrated after tubes or transistors have been replaced or repairs have been made. See the Maintenance section of this manual for servicing and repair information.

In the instructions that follow, the steps are arranged in convenient sequence to avoid unnecessary repetition. Each step that begins with the word "Check" is a performance or quality check that does not require an adjustment. Omit the "check" steps if you desire only an adjustment procedure. If individual steps are to be performed out of sequence, you will have to note the control settings and equipment connections used in preceding steps. Also, be sure to check any subsequent steps that might be affected by adjustments you have made. Power supply adjustments and crt replacement will affect the entire instrument.

Always calibrate the Type 564 with two plug-in units installed. When calibrating the entire system, start with the indicator unit (Type 564), then calibrate the amplifier unit and the time-base unit. Either plug-in unit can also be calibrated separately, but always begin the procedure by checking the Type 564 power supply voltages.

Do not preset any internal controls unless they are suspected of being grossly misadjusted, or unless repairs have been made in the circuit. In these cases, set the particular internal controls to midrange.

Equipment Required

The following (or equivalent) items of equipment are required for a complete calibration of the Type 564 Oscilloscope:

1. Tektronix 2-Series or 3-Series Amplifier plug-in unit (non-sampling). Bandpass to at least 1 Mc; deflection factors from 0.05 to 10 volts/div. Dual-trace or multi-trace unit preferred if available, for checking alternate-trace switching and chopped blanking.
2. Tektronix 2-Series or 3-Series Time-Base plug-in unit (non-sampling). Sweep rates to at least 1 μ sec/div; single-sweep capability; external horizontal input.
3. Tektronix 3-Series Time-Base plug-in unit with delayed-sweep feature, required only for checking delaying-sweep intensification. This unit may be used instead of item 2 for the entire procedure if it also has single-sweep capability and external horizontal input.
4. Square-wave generator. Output frequencies from 50 cps to 1 Mc; output amplitudes from 100 mv to at least 10 volts into 50 ohms. Tektronix Type 105 recommended.
5. Variable autotransformer. Output voltage variable from 105 to 125 volts ac rms for 117-volt nominal operation, or

from 210 to 250 volts for nominal 234-volt operation; output power 250 watts minimum.

6. Test oscilloscope. Bandpass from dc to at least 1 Mc; deflection factors from 0.01 (or less) to 20 volts/div; sweep rates to at least 1 μ sec/div; ac and dc input coupling; voltage and timing accuracy $\pm 3\%$. Tektronix Type 561A or Type 564 Oscilloscope with Type 3A1 and Type 2B67 Plug-In Units recommended, or Tektronix 530-, 540- or 550-Series Oscilloscope with Type 1A1, L, D, B or H Plug-In Unit.

7. $10\times$ Attenuator probe for test oscilloscope. Tektronix P6006 Probe recommended.

8. $1\times$ Test probe for checking power-supply ripple. Tektronix P6028 Probe recommended. A clip-lead adapter (Tektronix part number 013-076 for BNC, 013-003 for UHF) with a coaxial cable may be substituted for the $1\times$ probe.

9. Dc voltmeter. Voltage ranges from 0 to 3300 volts; impedance at least 20,000 Ω /volt; accuracy $\pm 1\%$ from 0 to 300 volts, $\pm 3\%$ at 3300 volts.

10. Ac voltmeter, for monitoring autotransformer output. Voltage range up to 150 volts ac rms (or up to 250 volts for 234-volt operation); accuracy $\pm 3\%$.

11. Ac voltmeter, for checking heater voltage. Range from 0 to 10 volts ac rms; accuracy $\pm 3\%$.

12. Ohmmeter, for checking continuity. Required only if amplifier plug-in unit is not a dual-trace or multi-trace unit.

13. Ammeter, for measuring beam current. Range from 0 to 60 μ amps; accuracy $\pm 3\%$ at 60 μ amps. Required for writing-speed measurement.

14. Two coaxial cables. Characteristic impedance 50 to 52 ohms; length approximately 42 inches. Tektronix part number 012-057 for BNC, 012-001 for UHF.

15. Three patch cords with banana jacks at both ends. Length approximately 18 inches. Tektronix part number 011-049.

16. 50-ohm termination. BNC connectors. Tektronix part number 011-049 recommended.

17. Plastic screwdriver-type adjustment tool. Tektronix part number 003-000 (1 $\frac{1}{2}$ -inch shaft) recommended.

18. Connector adapters as needed for connecting between instruments:

- UHF plug to BNC jack. Tektronix part number 103-015.
- BNC plug to UHF jack. Tektronix part number 103-032.
- BNC plug to binding-post. Tektronix part number 103-033.

19. Type 3M1 Deflection-Plate Capacitance Standardizer plug-in unit or capacitance meter, for adjusting deflection-plate capacitance. Meter accuracy $\pm 3\%$ at 14 pf. Required only if crt has been replaced.

PRELIMINARY PROCEDURE

The following preliminary steps are performed before beginning the calibration procedure:

1. Remove both side panels from the Type 564.
2. Insert the amplifier plug-in unit in the left (vertical) plug-in compartment and the time-base plug-in unit in the right (horizontal) plug-in compartment.
3. Connect the test instruments and autotransformer to the line voltage.
4. Connect the output of the autotransformer to the Type 564.
5. Install the 1X probe on the vertical input of the test oscilloscope.
6. Set front-panel controls:

Type 564

FOCUS	Counterclockwise
ASTIGMATISM	Counterclockwise
INTENSITY	Counterclockwise
SCALE ILLUM	PWR OFF
CALIBRATOR	OFF
WRITING RATE INCREASE*	Off (pushed in)
Upper DISPLAY	NON STORE
Lower DISPLAY	NON STORE
CRT CATHODE SELECTOR	EXT CRT CATHODE

Amplifier Unit

Input signal	None
Mode	Normal (Channel 1)
Volts/Div	5
Input coupling	AC
Position	Centered

Time-Base Unit

Input signal	None
Time/Div	5 μ sec
Mode	Single Sweep
Triggering	+ Internal, free run
Position	Centered

Test Oscilloscope

Horiz. mode	Normal
Sweep rate	5 msec/div
Triggering	+ Line, auto
Vertical mode	Normal (Channel 1)
Deflection factor	.005 volts/cm
Input coupling	AC

At the beginning of each step the control settings and interconnections are assumed to be the same as they were at the end of the preceding step unless otherwise noted.

* S/N 2000-up only

7. Turn on the test instruments and the Type 564 and set the autotransformer for design-center voltage of the Type 564 (117 or 234 volts). Monitor the autotransformer output with the 150-volt (or 250-volt) ac meter.

8. Allow at least 10 minutes warm up before making any checks or adjustments.

9. Read over the Crt Precautions in the Operating Instructions section ("Care of Storage Screens") before starting the calibration procedure.

POWER SUPPLY AND CRT CIRCUITS

1. Adjust Low-Voltage Supplies

Refer to Table 5-1 for output voltage, regulation and ripple tolerances during the following checks. Make adjustments in the sequence given in the table. Test points and adjustment controls are shown in Fig. 5-1.

NOTE

If you are not performing a complete recalibration, do not adjust any of the low-voltage supplies unless they are out of tolerance. Adjustment of these controls will necessitate a calibration check of the entire instrument.

a. Connect the dc voltmeter between chassis ground and the test point of each supply. Adjust the appropriate control if the output voltage is not within the specified tolerance.

b. Connect the dc voltmeter to each test point and vary the autotransformer output voltage from 105 to 125 volts (or 210 to 250 volts). The output of each supply should remain within the specified regulation tolerance.

c. Connect the 1X test probe to each test point and check for power supply ripple with the test oscilloscope.

d. Vary the autotransformer output voltage from 105 to 125 volts (or 210 to 250 volts) and check for ripple regulation. Ripple should not exceed the maximum given in Table 5-1.

e. Disconnect the probe.

f. Return the autotransformer output voltage to the design-center line voltage of the Type 564 (117 or 234 volts).

**TABLE 5-1
Low-Voltage Supplies**

Supply	Tolerance at 117 V (234 V)	Regulation 105-125 V (210-250 V)	Adjust	Ripple (Max.)
-100 volts	± 1.0 volt	± 2.0 volts	R616 (-100 VOLTS)	7 mv
+125 volts	± 1.5 volts	± 3.0 volts	R656 (+125 VOLTS)	14 mv
+300 volts	± 3.0 volts	± 6.0 volts	R676 (+300 VOLTS)	110 mv
-12.2 volts	± 0.1 volt	± 0.25 volt	R730 (-12.2 VOLTS)	4 mv

2. Check Unregulated Supplies

a. Connect the dc voltmeter between each unregulated voltage test point (see Fig. 5-1) and ground.

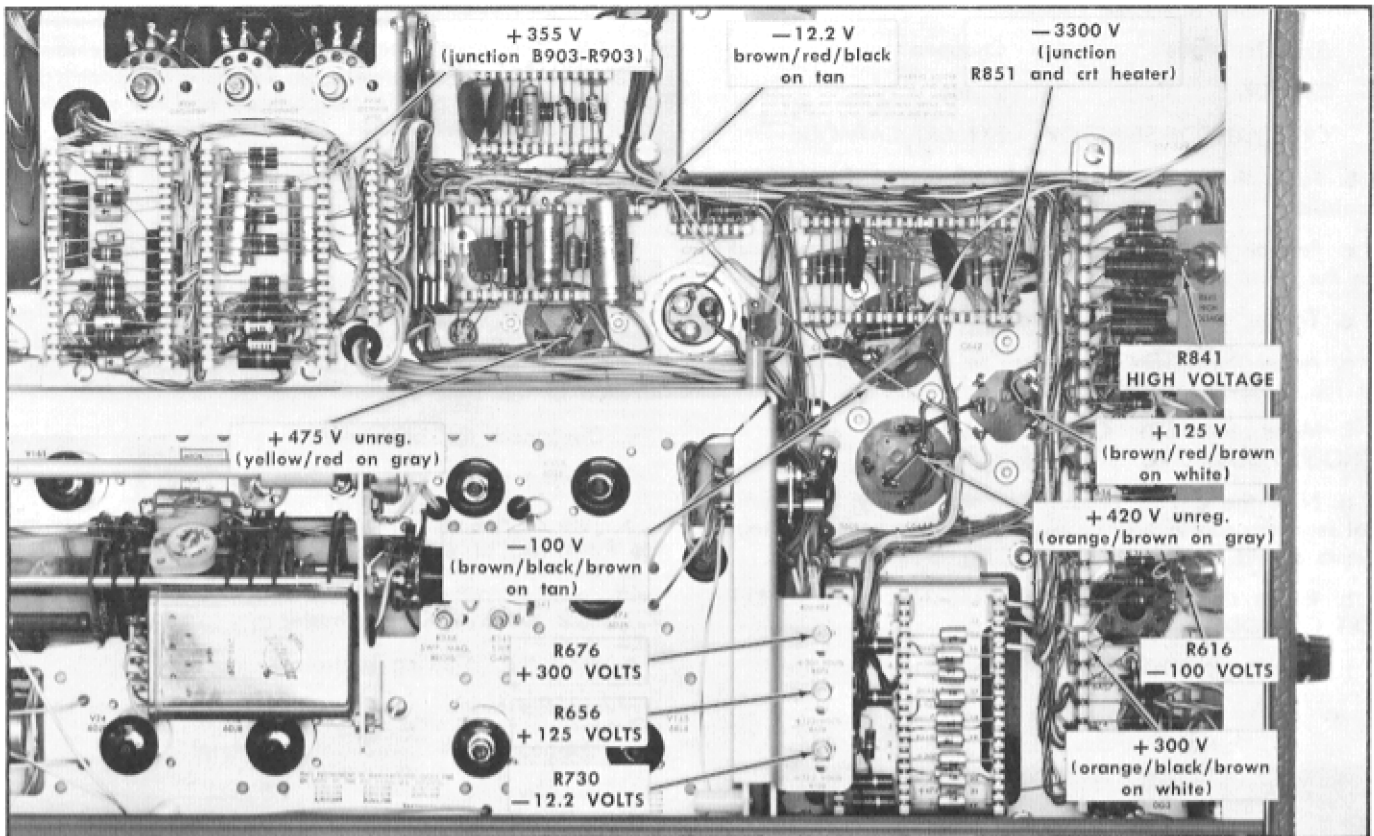

Fig. 5-1. Voltage test points and adjustments on right side of Type 564.

b. Check for correct voltages, as follows:

- +355 volts ± 15 volts*
- +420 volts ± 42 volts
- +475 volts ± 48 volts

3. Check Heater Voltages

a. Connect the 0-10-volt ac voltmeter between terminals 8 and 9 of T601. (See Maintenance section for terminal locations.)

b. Check for a heater voltage of 6.3 volts (± 0.7 volts) ac rms.

c. Connect the ac meter between terminals 5 and 6 of T601. (Caution: This supply is elevated to +125 volts.)

d. Check for 6.3 volts (± 0.7 volts) ac rms.

e. Do not check the crt heater voltage, elevated to -3300 volts.

4. Adjust High Voltage

a. Connect the dc voltmeter between the -3300-volt test point (see Fig. 5-1) and ground.

b. Check for -3300 volts (± 100 volts).

c. Adjust R841 (HIGH VOLTAGE) if required.

d. Disconnect the voltmeter.

* The +355-volt source is regulated through the +300-volt supply.

5. Check Alternate Trace

If a dual-trace or multi-trace amplifier plug-in unit is used:

a. Reset the following controls:

Amplifier Mode	Alternate
Channels 1 and 2	On
Time-base Mode	Normal

b. Set the Type 564 INTENSITY control for normal display brightness and check for two traces on the crt screen.

If a single-trace amplifier plug-in unit is used:

a. Turn off the Type 564.

b. Remove both plug-in units temporarily.

c. Make an ohmmeter continuity check between pin 4 of the interconnecting jack in the vertical plug-in compartment and pin 3 of the interconnecting jack in the horizontal plug-in compartment. Also check for infinite resistance between pins 3 and 4 of the vertical plug-in jack. Since the Type 564 merely interconnects the two plug-in units in Alternate mode, the continuity check also checks the alternate-trace function.

d. Perform steps 6a through 6e for single-trace plug-ins before reinserting the plug-in units.

6. Check Dual-Trace Blanking

If a dual-trace or multi-trace amplifier plug-in unit is used:

Calibration—Type 564

- a. Reset the following controls:

Amplifier Mode	Chopped
Time/Div	2 μ sec
CRT CATHODE SELECTOR	EXT CRT CATHODE

- b. Focus the trace with the FOCUS and ASTIGMATISM controls.

- c. Position the two traces about 2 major divisions apart on the crt screen.

- d. Trigger the chopped waveform.

- e. Adjust the INTENSITY control so the vertical segments of the chopped waveform are barely visible.

- f. Move the CRT CATHODE SELECTOR switch to CHOPPED BLANKING.

- g. Note the change produced in the display. The vertical segments should now be blanked and the horizontal segments should be intensified. (See Fig. 5-2.)

- h. Return the CRT CATHODE SELECTOR switch to EXT CRT CATHODE position.

- i. Turn the INTENSITY control fully counterclockwise.

If a single-trace amplifier plug-in unit is used:

- a. (With power off and amplifier plug-in unit removed) connect the ohmmeter between pin 24 of the interconnecting jack in the vertical plug-in compartment and the center terminal of switch SW854 (CRT CATHODE SELECTOR).

- b. Check for a meter reading of infinity (open circuit) with the switch in the EXT CRT CATHODE position.

- c. Set the CRT CATHODE SELECTOR switch to CHOPPED BLANKING.

- d. Check for a meter reading of zero (closed circuit). Together with the following external-cathode intensity modulation check, this continuity check tests the chopped blanking function of the Type 564.

- e. Disconnect the ohmmeter.

- f. Reinsert the plug-in units into the Type 564.

- g. Turn on the oscilloscope and allow a few minutes for the instrument to warm up again.

7. Check External Crt Cathode

- a. Reset the following controls:

Amplifier Mode	Normal (Channel 1)
Time-base Mode	Normal
Time/Div	5 μ sec
CRT CATHODE SELECTOR	CHOPPED BLANKING

- b. Disconnect the ground strap from the EXT CRT CATHODE connector.

- c. Install a 50-ohm termination on the output of the Type 105 Square-Wave Generator.

- d. Set the Type 105 for minimum output amplitude and an output frequency of 100 kc.

- e. Connect the Type 105 output to the amplifier unit input connector (Channel 1) and to the EXT CRT CATHODE connector. Use three patch cords and adapters as necessary.

- f. Adjust the INTENSITY control for normal brightness.

- g. Focus the free-running display.

- h. Adjust the Type 105 output amplitude to produce approximately 2 major divisions of deflection.

- i. Trigger the square-wave display. (Some ringing may be apparent on the waveform due to the unshielded leads.)

- j. Decrease the intensity until the waveform is barely visible.

- k. Set the CRT CATHODE SELECTOR switch to EXT CRT CATHODE. The top portions of the waveform should be blanked completely and the bottom portions should be intensified.

- l. Set the switch to CHOPPED BLANKING again.

- m. Set the amplifier unit Volts/Div switch to 1.

- n. Adjust the Type 105 output amplitude to produce 3 major divisions of deflection.

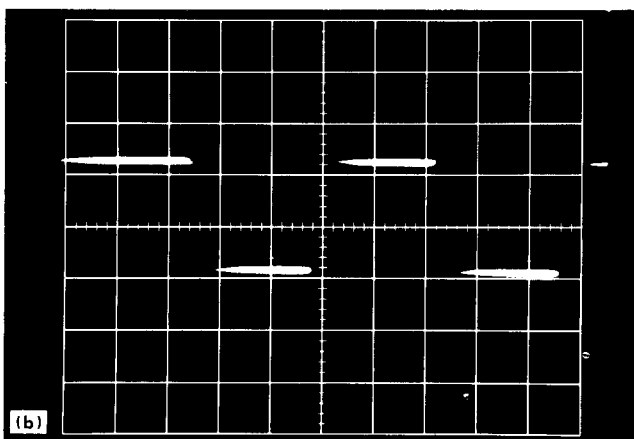
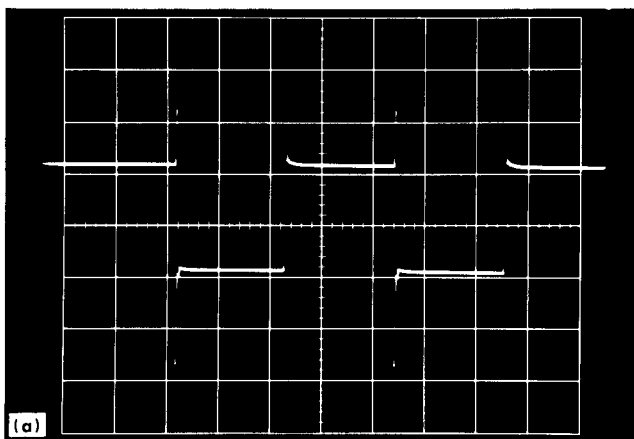

Fig. 5-2. Dual-trace blanking check with dual-trace unit in Chopped mode. Waveforms with CRT CATHODE SELECTOR switch set at: (a) EXT CRT CATHODE; (b) CHOPPED BLANKING.

- o. Move the signal lead from the amplifier input to the external trigger input of the time-base unit.
- p. Set the time-base unit for external triggering.
- q. Trigger the sweep.
- r. Set the CRT CATHODE SELECTOR switch to EXT CRT CATHODE. Appreciable intensity modulation should be visible with the 3-volt signal applied. (See Fig. 5-3.)
- s. Remove the patch cords and adapters.
- t. Reconnect the ground strap to the EXT CRT CATHODE connector. Leave the switch in the EXT CRT CATHODE position.

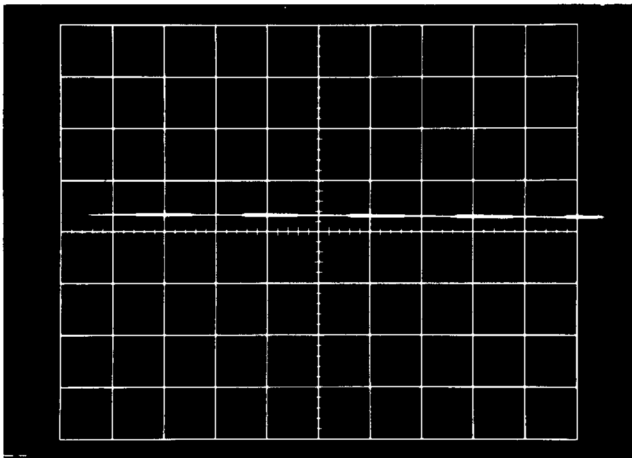

Fig. 5-3. External Crt Cathode check showing intensity modulation.

8. Adjust Trace Alignment

- a. Reset the time-base controls:

Time/Div	1 msec
Triggering	+ Internal, free run
- b. Position the trace at the center of the crt screen.
- c. Adjust the FOCUS and ASTIGMATISM controls to focus the trace.
- d. Adjust the front-panel TRACE ALIGNMENT screwdriver control to align the trace with the horizontal graticule centerline.

9. Check Crt Vertical Deflection Factor

- a. Connect the dc voltmeter (200-volt scale) between the two vertical deflection-plate neck pins (BLUE and BROWN leads). Do not short to the crt shield.
- b. Position the trace to the top graticule line.
- c. Note and record the meter reading.
- d. Position the trace to the bottom graticule line.
- e. Again note and record the meter reading.
- f. Determine the voltage swing over the 8 major divisions. This should be between 144 and 168 volts, representing a crt vertical deflection factor between 18 and 21 volts/div.

10. Check Crt Vertical Electrical Center

- a. With the voltmeter connected between the vertical deflection-plate neck pins, position the trace near the center of the crt.
- b. Note the vertical position of the trace when the meter reads zero volts. This is the crt vertical electrical center. The trace should now be within 1 major division of the graticule centerline.
- c. Disconnect the voltmeter.

11. Check Crt Horizontal Deflection Factor

- a. Turn the INTENSITY control fully counterclockwise.
- b. Set the time-base unit for external horizontal input.
- c. Connect the dc voltmeter (200-volt scale) between the two horizontal deflection-plate neck pins (GREEN and RED leads). Do not short to the crt shield.
- d. Adjust the INTENSITY control to display a dim spot on the crt screen.
- e. Position the spot to the left edgeline of the graticule.
- f. Note and record the meter reading.
- g. Position the spot to the right edgeline of the graticule.
- h. Again note and record the meter reading.
- i. Determine the voltage swing over the 10 major divisions. This should be between 170 and 200 volts, representing a crt horizontal deflection factor between 17 and 20 volts/div.

12. Check Crt Horizontal Electrical Center

- a. With the voltmeter connected between the horizontal deflection-plate neck pins, position the spot near the center of the crt.
- b. Note the horizontal position of the spot when the meter reads zero volts. This is the crt horizontal electrical center. The spot should now be within 1 major division of the vertical centerline.
- c. Disconnect the voltmeter.

13. Check Delaying Sweep Intensification

This check can be made only with a time-base unit having the delayed-sweep feature.

- a. Turn the INTENSITY control fully counterclockwise.
- b. Remove the one-sweep time-base unit.
- c. Check the voltage at the junction of D838 and D839. Should not be higher than +0.6 volts. (Do not insert delayed-sweep unit if voltage exceeds +0.6 volts.)
- d. Install the delayed-sweep time-base unit in the horizontal plug-in compartment. Allow about 3 minutes for warm up.
- e. Set the time-base front-panel controls:

Mode	Normal
Normal Sweep rate	1 msec/div.

Calibration—Type 564

Normal Triggering	Free run (auto)
Delayed Sweep rate	.1 msec/div.
Delayed Triggering	Free run
Delay time	Centered

- f. Set the Type 564 INTENSITY control for a trace of normal brightness.
- g. Switch the time-base Mode switch to Intensified. Only the intensified portion of the delaying (normal) sweep should now be visible on the crt screen.
- h. Turn the Delay Time control. The intensified portion of the trace should move smoothly across the screen.
- i. Turn the INTENSITY control fully counterclockwise.
- j. Remove the delayed-sweep time-base unit and reinsert the time-base unit used for previous steps.

14. Adjust Crt Deflection-Plate Capacitance

Omit this step unless the crt has been replaced.

After installation of a new crt, the effective deflection-plate capacitance must be adjusted to a standard value with trimmer capacitors C760 and C761. These adjustments can be made either with a Tektronix Type 3M1 Crt Deflection Capacitance Standardizer plug-in unit or (less directly) through the use of a capacitance meter. To use a Type 3M1 for the adjustments, refer to the instruction manual for that unit. The following procedure describes the method of adjustment using a capacitance meter.

Since the deflection plates are driven push-pull, their effective capacitance as seen by the plug-in unit cannot be

measured directly. It can, however, be calculated from the measured circuit capacitances represented schematically in Fig. 5-4.

Preliminary

- a. Turn off the Type 564 and disconnect the power cord.
- b. Insulate the oscilloscope chassis from earth ground.
- c. Remove both plug-in units.

Vertical Deflection-Plate Capacitance

- a. Connect the guard voltage lead of the capacitance meter to pin 21 of the interconnecting jack in the vertical plug-in compartment.
- b. Measure the capacitance between pin 17 and the oscilloscope chassis. This is the value of C_1 in Fig. 5-4.
- c. Connect the guard voltage lead to the oscilloscope chassis.
- d. Measure the capacitance between pins 17 and 21 of the interconnecting jack. This is the value of C_3 in Fig. 5-4.
- e. Substitute the measured values for C_1 and C_3 in equation (2) below and solve for the value of C_2 . Effective deflection-plate capacitance should be 14.3 picofards (factory standard).

$$C_{err} = \frac{C_1 + C_3}{2} + 2 C_2 \quad \text{Equation (1)}$$

$$C_2 = 28.6 \text{ pf} - C_1 - 4 C_3 \quad \text{Equation (2)}$$

- f. Connect the guard voltage lead to pin 17 of the interconnecting jack.
- g. Measure the capacitance between pin 21 and the oscilloscope chassis. This should be equal to the calculated value of C_2 .
- h. Adjust C760 if the measured value does not equal the calculated capacitance for C_2 . C760 is mounted just above the interconnecting jack at the rear of the vertical plug-in compartment.

Horizontal Deflection-Plate Capacitance

- a. Using the procedure just described (steps a through e), connect the capacitance meter to the appropriate pins of the horizontal plug-in jack and determine the value of C_2 for the horizontal deflection plates.
- b. Connect the guard voltage lead to pin 17 of the interconnecting jack.
- c. Measure the capacitance between pin 21 and the oscilloscope chassis. This should be equal to the calculated value of C_2 .
- d. Adjust C761 if the measured value does not equal the calculated capacitance for C_2 . C761 is mounted just above the interconnecting jack at the rear of the horizontal plug-in compartment.
- e. Disconnect the capacitance meter.

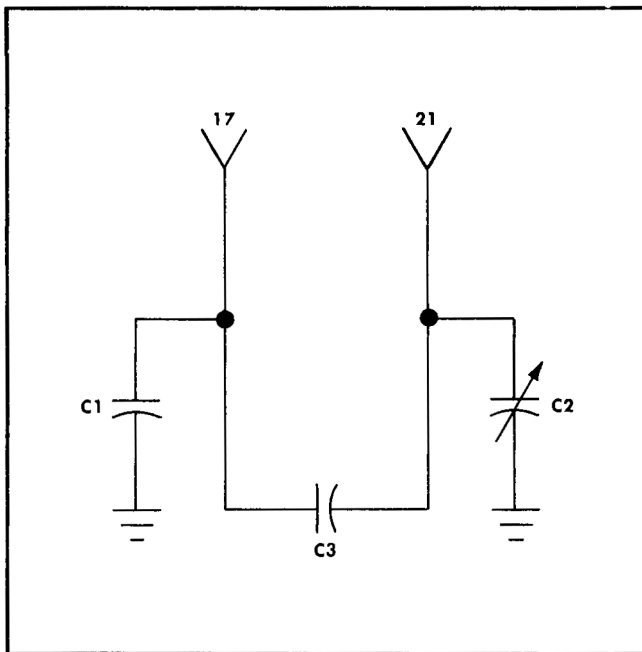

Fig. 5-4. Schematic representation of effective crt deflection-plate capacitance. C_1 and C_2 are capacitances from each plate to ground; C_3 is total capacitance between deflection plates.

CALIBRATOR CIRCUIT

15. Adjust Calibrator Amplitude

- a. If the plug-in units were removed and power disconnected to adjust the crt deflection-plate capacitance, reinsert the plug-in units, connect the design-center line voltage and turn on the power. Allow about 10 minutes for warm up.
- b. Check that the CALIBRATOR switch is set to OFF.
- c. Connect the dc voltmeter (100-volt range) between pin 7 of V884 and ground.
- d. Adjust R871 (CAL AMPL) for a meter reading of +100 volts. The location of R871 is shown in Fig. 5-5.

16. Check Calibrator Symmetry

- a. With the dc voltmeter connected to pin 7 of V884, set the CALIBRATOR switch to .2 mVOLTS.
- b. Check for meter reading between 40 and 60 volts, indicating waveform symmetry of 40/60 or better.
- c. Set the CALIBRATOR switch to each of its 18 positions and check symmetry. See the troubleshooting table in the Maintenance section if the voltage reading is not in the 40- to 60-volt range.

- d. Disconnect the voltmeter.

17. Check Calibrator Risetime

- a. Set the CALIBRATOR switch to 100 VOLTS.
- b. Install the 10X attenuator probe on the test oscilloscope vertical input.
- c. Set the test oscilloscope controls:

Horiz. mode	Normal
Sweep rate	1 μ sec/div
Triggering	+ Internal
Vertical mode	Normal (Channel 1)
Deflection factor	5 volts/div
Input coupling	DC
- d. Connect the probe tip to the CAL OUT connector or to the Calibrator output lead behind the front panel.
- e. Trigger the test oscilloscope display to observe the rising portion of the Calibrator waveform.
- f. Adjust the test oscilloscope intensity and focus.
- g. Measure the Calibrator 10% to 90% risetime with the test oscilloscope. Risetime should be 5 μ sec or less.

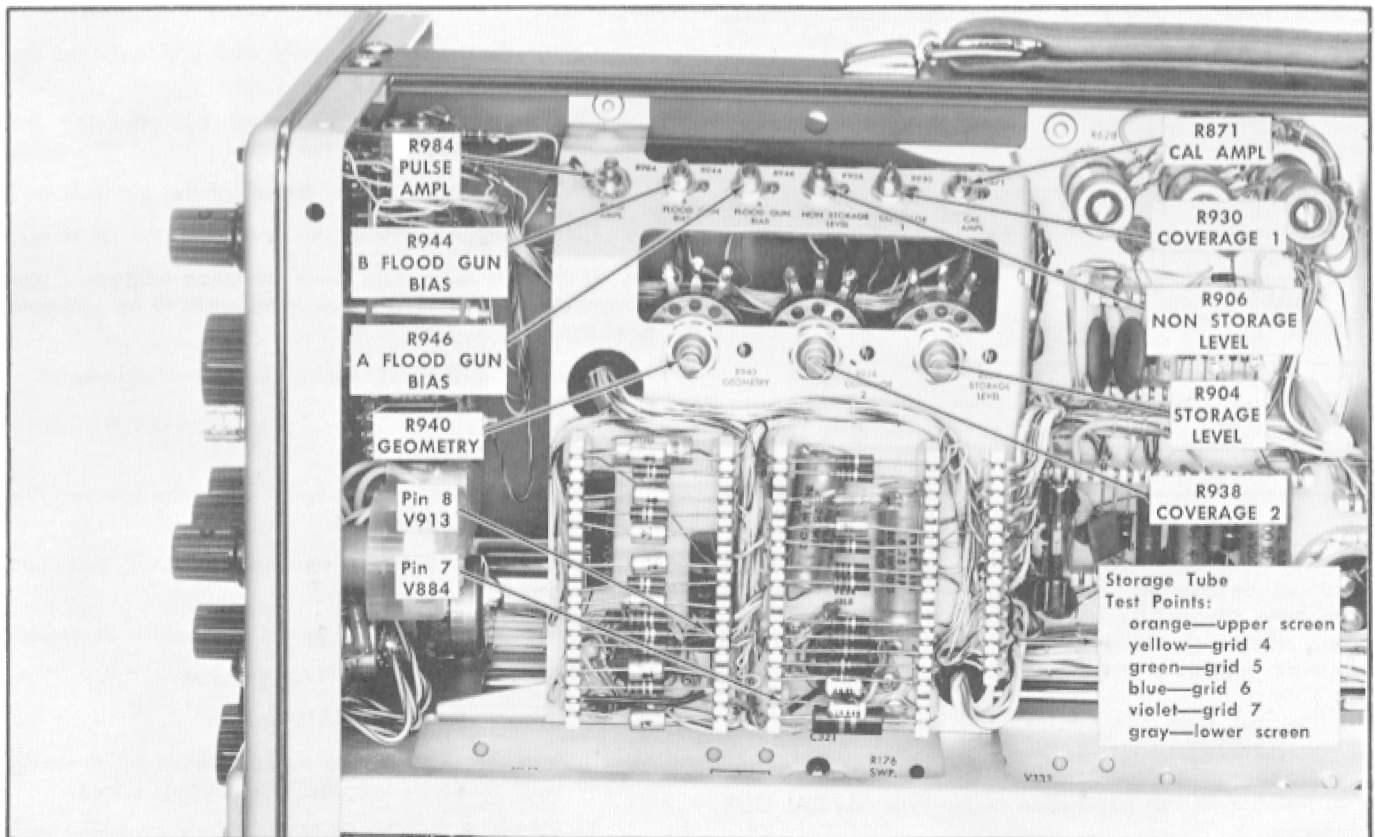

Fig. 5-5. Storage circuit and calibrator test points and adjustments on right side of Type 564.

Calibration—Type 564

18. Check Calibrator Attenuator

a. Reset the following test oscilloscope controls:

Sweep rate	10 msec/div
Deflection factor	2 volts/div
Variable (volts/div)	Calibrated

b. With the test probe connected to the Type 564 CAL OUT, decrease the test oscilloscope intensity to normal and focus the display.

c. Set the baseline of the Calibrator waveform 1 major division above the bottom graticule line. (There should now be 5 divisions of deflection. If your test oscilloscope has a 4-division crt screen, increase the deflection factor to 5 volts/div.)

d. Check the Calibrator attenuator accuracy with the test oscilloscope, from 100 VOLTS through 50 mVOLTS, as outlined in Table 5-2. Accuracy on all steps should be within 4% (including the test oscilloscope attenuator accuracy).

TABLE 5-2
Calibrator Attenuator Check

CALIBRATOR (VOLTS)	Test Volts/Div	Deflection (div.)
100	20	5
50	10	5
20	5	4
10	2	5
5	1	5
2	.5	4
1	.2	5
.5	.1	5
.2	.05	4
.1	.05	2
50 mV	.05	1

e. The Calibrator attenuator steps below 50 mVOLTS need not be checked, since all of the attenuator resistors have been checked by the procedure just given (see Calibrator schematic). However, all of those steps will include any error appearing at the 50 mVOLTS position.

f. Set the Type 564 CALIBRATOR switch to .5 VOLTS (.1 V INTO 50 Ω).

g. Install a 50-ohm termination on the Type 564 CAL OUT connector.

h. Set the test oscilloscope deflection factor to .02 volts/div.

i. Remove the 10× probe from the test oscilloscope input and connect a 50-ohm coaxial cable from the 50-ohm termination on the Type 564 CAL OUT connector to the test oscilloscope input connector.

j. Check the output amplitude with the test oscilloscope. When terminated in 50 ohms, the amplitude should be 0.1 volt with the CALIBRATOR switch at the .5 VOLTS position.

k. Remove the termination and disconnect the cable.

l. Set the CALIBRATOR switch to OFF.

STORAGE CIRCUITS

19. Adjust Geometry (Flood-Gun Anode)

a. Reset the following controls:

Time-base Mode	Normal
Time/div	.1 msec
Triggering	+ Internal, free run

b. Connect the ac voltmeter between the geometry neck pin (ORANGE) and ground.

c. Adjust R940 (GEOMETRY) for a meter reading of +180 volts. The location of R940 is shown in Fig. 5-5.

d. Disconnect the meter.

e. Adjust the INTENSITY control for a trace of normal brightness.

f. Center the trace horizontally and position it to the top of the graticule.

g. Check the geometry adjustment by observing the alignment and curvature of the trace.

h. Position the trace to the bottom of the graticule.

i. Check the geometry at the bottom of the crt screen.

j. If there is more than 2 mm deviation (alignment plus curvature) over the 10 divisions, readjust R940 for minimum deviation.

k. Turn the INTENSITY control fully counterclockwise.

20. Adjust Flood-Gun Bias

a. Fade the screen positive (i.e., "write" the screens fully) using the following procedure:

(1). Press both DISPLAY switches to ERASE and hold them there.

(2). Press the INTEGRATE button and hold it depressed.

(3). Release the two DISPLAY switches.

(4). Release the INTEGRATE button.

(The screens may also be faded positive by sweeping them with moderate-intensity free-running trace.)

b. Turn R944 (B FLOOD GUN BIAS) fully clockwise, then turn it counterclockwise until the screens are uniformly bright. Do not adjust R944 counterclockwise any farther than necessary. See Fig. 5-5 for the location of R944.

c. Adjust R946 (A FLOOD GUN BIAS) in the same manner as R944.

21. Adjust Collimation-Electrode Voltages

a. With the screens faded positive, turn R938 (COVERAGE 2) fully counterclockwise, then clockwise until the screens brighten appreciably.

b. Turn the control slightly counterclockwise again to the point where the screens just begin to brighten. The entire area of the screens should display a uniform light level.

c. Turn R930 (COVERAGE 1) fully counterclockwise, then clockwise until the background light level is uniform out to the edges of the graticule area. Do not adjust R930 farther than necessary.

d. Press both DISPLAY switches to ERASE, then fade the screens positive again (as in step 20a). Recheck the coverage at the edges of the screens.

e. Remove the screens from the fade-positive state by pressing both DISPLAY switches to ERASE, then releasing them to STORE position.

f. Check the screens for any apparent reflections near the edges. If reflections appear, turn R930 clockwise slightly and check step 21d again.

g. If R930 cannot be satisfactorily adjusted for edge uniformity (while faded positive) without causing reflections on the screen (in storage mode), readjust R939 (COVERAGE 2) as described in steps 21a and 21b, then adjust R930 again.

h. Press the Upper DISPLAY switch to ERASE and check for uniform coverage while the switch is held at ERASE.

i. Set the Upper DISPLAY switch to NON STORE.

j. Check the lower screen for collimation with the Lower DISPLAY switch at ERASE, then set the switch to NON STORE.

22. Standardize Writing-Beam Current

a. Turn off the power switch (SCALE ILLUM) to make the following connection.

b. Carefully disconnect the clip lead from the left horizontal deflection-plate neck pin (RED lead).

c. Connect one lead of the ammeter (60 μ amp scale) to the neck pin and the other meter lead to the deflection-plate lead. Be careful not to bend the crt neck pin.

d. Insulate the deflection-plate lead from chassis ground.

e. Reset the following controls:

INTENSITY	Counterclockwise
Amplifier Position	Centered
Time-base Position	Counterclockwise
Time-base Mode	Normal, External Input
Upper DISPLAY	NON STORE
Lower DISPLAY	NON STORE

f. Turn on the Type 564.

g. After about 1 minute of warm up, adjust the INTENSITY control to produce 60 μ amps of beam current in the left horizontal deflection plate, as indicated on the ammeter.

h. Adjust the amplifier unit Position control for a maximum reading on the meter, then readjust the INTENSITY control

if necessary for 60 μ amps of beam current. DO NOT move the spot onto the crt screen with the time-base unit Position control.

i. Note and record the setting of the INTENSITY control knob, as this setting will be used to set beam current in later steps of the calibration procedure.

CAUTION

During subsequent steps, be sure the time-base Mode switch remains at Single Sweep whenever the INTENSITY control is set at this high level.

j. Turn off the Type 564, disconnect the ammeter and reconnect the deflection-plate lead to the crt neck pin.

k. Turn on the Type 564 and allow 2 or 3 minutes for warm up.

l. Reset the following controls:

INTENSITY	Counterclockwise
Time-base Mode	Single Sweep
Time/Div	.1 msec
Time-base Position	Centered

23. Adjust Storage Level

a. Connect the dc voltmeter (300-volt scale) between ground and pin 8 of V913 (lower storage-target backplate). See Fig. 5-5.

b. Set the INTENSITY control to the 60- μ amp position determined in step 22.

c. Apply several single sweeps of the trace, center the trace on the crt screen and adjust the FOCUS and ASTIGMATISM controls for well-defined trace.

d. Turn R904 (STORAGE LEVEL) fully counterclockwise.

e. Set both DISPLAY switches to STORE.

f. Advance R904 slowly in the clockwise direction until some portions of the screens begin to have a slight background glow.

g. Press both DISPLAY switches to ERASE, then release them to STORE position.

h. After about 15 seconds, apply single sweeps at several vertical positions on the crt screen and check the display for storage. The traces should not store well at this setting.

i. Note the voltage reading on the meter. (This voltage need not be recorded.)

j. Advance R904 clockwise just enough to produce a 5-volt change on the meter.

k. Erase the screens again.

l. After 15 seconds, observe another series of single sweeps at several vertical positions on the screens.

m. Continue advancing R904 in 5-volt increments (erasing and waiting 15 seconds at each setting) until the single-sweep traces will store anywhere on the screens with breaks no longer than about $\frac{1}{8}$ th inch (see Fig. 5-6a). Storage does not occur on the screen-separation line.

n. Note and record the voltage reading on the meter. This is the retention threshold (E_{RET}).

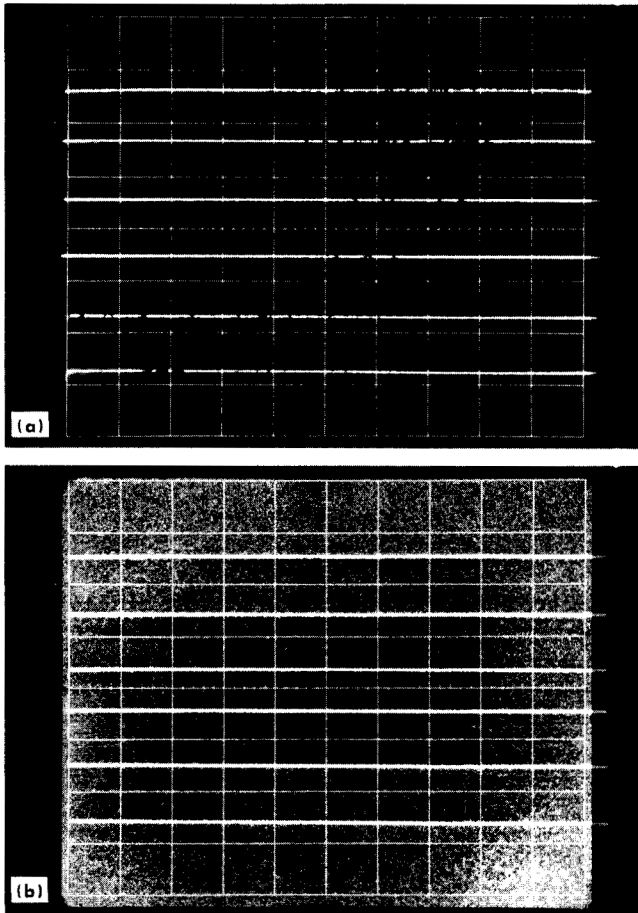

Fig. 5-6. Storage level adjustment: (a) retention threshold; (b) fade-positive threshold.

o. Continue to advance R904 in 5-volt increments (erasing and waiting 15 seconds) until the single-sweep traces start to spread into the background (Fig. 5-6b).

p. Note and record this meter voltage as the fade-positive threshold (E_{FP}).

q. Set R904 for a meter reading midway between the retention threshold and the fade-positive threshold. This is the normal storage-backplate operating level (E_{OL}).

$$E_{OL} = \frac{E_{RT} + E_{FP}}{2}$$

r. Disconnect the voltmeter.

24. Adjust Non Storage Level

a. Press both DISPLAY switches to ERASE, and release to STORE.

b. Set one DISPLAY switch to NON STORE.

c. Press the second DISPLAY switch to ERASE, then release it to STORE.

d. Adjust R906 (NON STORAGE LEVEL) for the best division between the two screens, with no background glow on the non-stored screen. (See Fig. 5-7.)

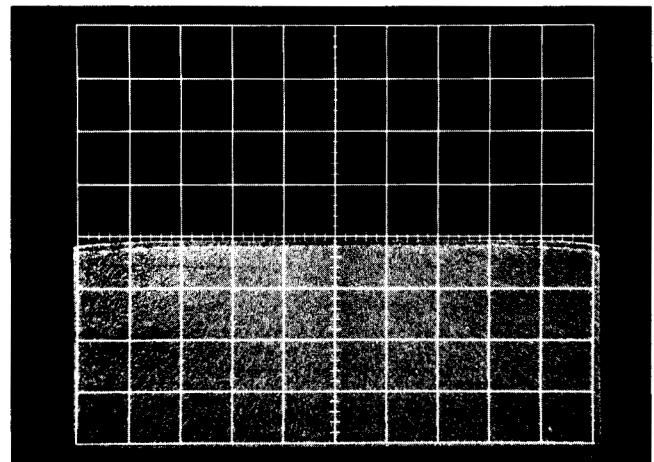

Fig. 5-7. Non-Storage level adjustment, with Upper DISPLAY switch at NON STORE and Lower DISPLAY switch at STORE.

e. Move the (second) DISPLAY switch to NON STORE. The screen must become dark quickly and completely without disturbing the other screen.

f. Press both DISPLAY switches to ERASE, then repeat steps 24b through 24e.

25. Check Writing Speed

a. Reset the following Type 564 controls:

Upper DISPLAY	NON STORE
Lower DISPLAY	NON STORE
Amplifier Volts/Div	2
Time-base Time/Div	.1 msec
Triggering	Free run

b. Set the test oscilloscope controls:

Horiz. Mode	Normal
Sweep Rate	5 μ sec/div
Triggering	+ Internal
Vertical Mode	Normal (Channel 1)
Deflection Factor	2 volts/div
Input Coupling	AC

c. Set the Type 564 INTENSITY control for a beam current of 60 μ amps (determined in step 22).

d. Apply several single sweeps of the trace and adjust the FOCUS and ASTIGMATISM controls for a well-defined trace.

e. Press both DISPLAY switches to ERASE, then release to STORE position.

f. Alternately store and erase single sweeps of the trace while continually increasing the sweep rate in small steps. With the time-base Time/Div. switch and Variable control, adjust the sweep rate for the fastest sweep that will permit

the trace to store anywhere on the center 6-cm by 8-cm area of the screens with breaks in the trace not exceeding 1 mm. This is the maximum writing speed of the crt. (Do not change the settings of the Time/Div or Variable controls until the sweep rate has been measured.)

g. Use the following procedure to determine the sweep speed of the Type 564 at maximum writing speed:

(1). Reset only the following controls:

INTENSITY	Counterclockwise
Upper DISPLAY	NON STORE
Lower DISPLAY	NON STORE
Time-base Mode	Normal

(2). Apply the output of the Type 105 Square-Wave Generator to the vertical input of the amplifier unit.

(3). Adjust the Type 564 INTENSITY control for normal brightness.

(4). Adjust the output amplitude of the Type 105 to produce approximately 2 major divisions of deflection.

(5). Trigger the square-wave display.

(6). Adjust the Type 564 FOCUS and ASTIGMATISM controls.

(7). Adjust the Type 105 output frequency to display exactly 1 cycle per division on the Type 564 crt screen. (Now do not change the Type 105 output frequency.)

(8). Turn the INTENSITY control fully counterclockwise.

(9). Move the square-wave signal from the amplifier input to the vertical input of the test oscilloscope.

(10). Trigger the test oscilloscope display.

(11). With the test oscilloscope, measure the time for one complete cycle of the square wave. This is the sweep time per division at the maximum writing speed of the storage tube.

h. Determine the writing speed of the Type 564, in divisions (cm)/msec, by calculating the reciprocal of the sweep time/division. For example:

$$\begin{aligned} \text{If: } \text{Sweep time/div} &= 33 \mu\text{sec,} \\ \text{Then: Writing speed} &= 1 \text{ div}/33 \mu\text{sec} \\ &= 30 \text{ div(cm)}/\text{msec.} \end{aligned}$$

i. The writing speed can be increased (at the expense of contrast ratio) by raising the operating level voltage on the storage-target backplate (see step 23).

NOTE

The operating level must be at least 10 volts below the fade-positive threshold.

26. Adjust Enhancement Pulse Amplitude (S/N 2000-up)

a. Reset the following controls:

Upper DISPLAY	NON STORE
Lower DISPLAY	NON STORE

Time-base Mode	Single Sweep
Time/Div	.1 msec
Variable	Calibrated
Triggering	Free run

b. Set the INTENSITY control for a beam current of 60 μ amps (determined in step 22).

c. Apply several single sweeps of the trace and adjust the FOCUS and ASTIGMATISM controls for a well-defined trace.

d. Press both DISPLAY switches to ERASE, then release to STORE.

e. Turn on (pull out) the WRITING RATE INCREASE switch and turn the control fully clockwise.

f. Set R984 (PULSE AMPL) fully counterclockwise.

g. Alternately store and erase single sweeps of the trace while adjusting R984 clockwise in small steps. Continue adjusting R984 until the single-sweep switching-sync pulses cause portions of the screens to start fading positive and the trace just begins to spread into the background. (See Fig. 5-8.)

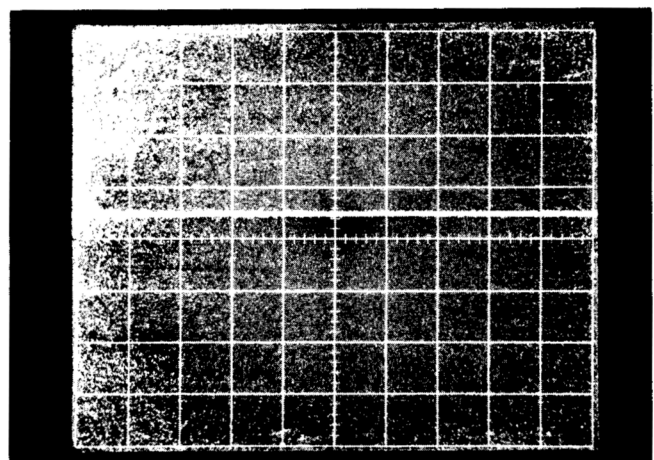

Fig. 5-8. Enhancement pulse amplitude adjustment, with WRITING RATE INCREASE control set to maximum.

27. Check Writing Speed Increase (S/N 2000-Up)

a. Leave the WRITING RATE INCREASE control turned on (pulled out) and turned fully clockwise.

b. Set both DISPLAY switches to ERASE, then release to STORE.

c. Check the writing speed of the storage tube as in step 25c through 25h, but with the WRITING RATE INCREASE turned on fully. Use only one single sweep of the crt screen for each display. When determining the sweep rate, turn off (push in) the WRITING RATE INCREASE switch.

d. Determine the increase in writing speed. This should be typically 10:1 for a T5640-200 crt, or 5:1 for a T5640-201 crt.

Calibration—Type 564

28. Check Locate Operation

- a. Reset the following controls:

INTENSITY	Counterclockwise
Time/Div	.1 msec
Variable	Calibrated
Triggering	Free run

b. Adjust the INTENSITY control to display a very dim trace.

c. Position the free-running trace so that it starts exactly at the left edge of the graticule.

d. Set the time-base Mode switch to Single Sweep.

e. Press the LOCATE button. A spot should appear off-screen at the left edge of the graticule, at the level of the trace. The spot should not store in the edge area. Note that the Position control on the amplifier unit moves the spot vertically.

f. Release the button.

29. Check Integrate Function

- a. Reset the following controls:

Upper DISPLAY	STORE
Lower DISPLAY	STORE
Time/Div	5 μ sec

b. Press both DISPLAY switches to ERASE, then release to STORE.

c. Set the INTENSITY control to the point that will allow single sweeps to be seen, but will not allow them to store.

d. Press the DISPLAY switches to ERASE, then release them to STORE.

e. Press the INTEGRATE button and hold it.

f. Actuate approximately 5 single sweeps of the trace, without changing the setting of either Position control.

g. Release the INTEGRATE button. A stored trace should be present on the screen.

h. Press the DISPLAY switches to ERASE and release to STORE.

i.* Turn on (pull out) the WRITING RATE INCREASE switch and turn the control fully clockwise.

j.* Press the INTEGRATE button and release it. Most of the screen should fade positive as the INTEGRATE button pulses the trace-enhancement circuit.

k.* Turn off (push in) the WRITING RATE INCREASE switch.

l. Erase the screens and set the DISPLAY switches to NON STORE.

m. Turn the INTENSITY control fully counterclockwise.

*Does not apply below 5/N 2000.

SECTION 6

PARTS LIST and DIAGRAMS

PARTS ORDERING INFORMATION

Replacement parts are available from or through your local Tektronix Field Office.



Changes to Tektronix instruments are sometimes made to accommodate improved components as they become available, and to give you the benefit of the latest circuit improvements developed in our engineering department. It is therefore important, when ordering parts, to include the following information in your order: Part number including any suffix, instrument type, serial number, and modification number if applicable.

If a part you have ordered has been replaced with a new or improved part, your local Tektronix Field Office will contact you concerning any change in part number.

ABBREVIATIONS AND SYMBOLS

a or amp	amperes	mm	millimeter
BHS	binding head steel	meg or M	megohms or mega (10 ⁶)
C	carbon	met.	metal
cer	ceramic	μ	micro, or 10 ⁻⁶
cm	centimeter	n	nano, or 10 ⁻⁹
comp	composition	Ω	ohm
cps	cycles per second	OD	outside diameter
crt	cathode-ray tube	OHS	oval head steel
CSK	counter sunk	p	pico, or 10 ⁻¹²
dia	diameter	PHS	pan head steel
div	division	piv	peak inverse voltage
EMC	electrolytic, metal cased	plstc	plastic
EMT	electrolytic, metal tubular	PMC	paper, metal cased
ext	external	poly	polystyrene
f	farad	Prec	precision
F & I	focus and intensity	PT	paper tubular
FHS	flat head steel	PTM	paper or plastic, tubular, molded
Fil HS	fillister head steel	RHS	round head steel
g or G	giga, or 10 ⁹	rms	root mean square
Ge	germanium	sec	second
GMV	guaranteed minimum value	Si	silicon
h	henry	S/N	serial number
hex	hexagonal	t or T	tera, or 10 ¹²
HHS	hex head steel	TD	toroid
HSS	hex socket steel	THS	truss head steel
HV	high voltage	tub.	tubular
ID	inside diameter	v or V	volt
incd	incandescent	Var	variable
int	internal	w	watt
k or K	kilohms or kilo (10 ³)	w/	with
kc	kilocycle	w/o	without
m	milli, or 10 ⁻³	WW	wire-wound
mc	megacycle		

SPECIAL NOTES AND SYMBOLS

X000	Part first added at this serial number.
000X	Part removed after this serial number.
*000-000	Asterisk preceding Tektronix Part Number indicates manufactured by or for Tektronix, or reworked or checked components.
Use 000-000	Part number indicated is direct replacement.
	Internal screwdriver adjustment.
	Front-panel adjustment or connector.

FRONT & REAR

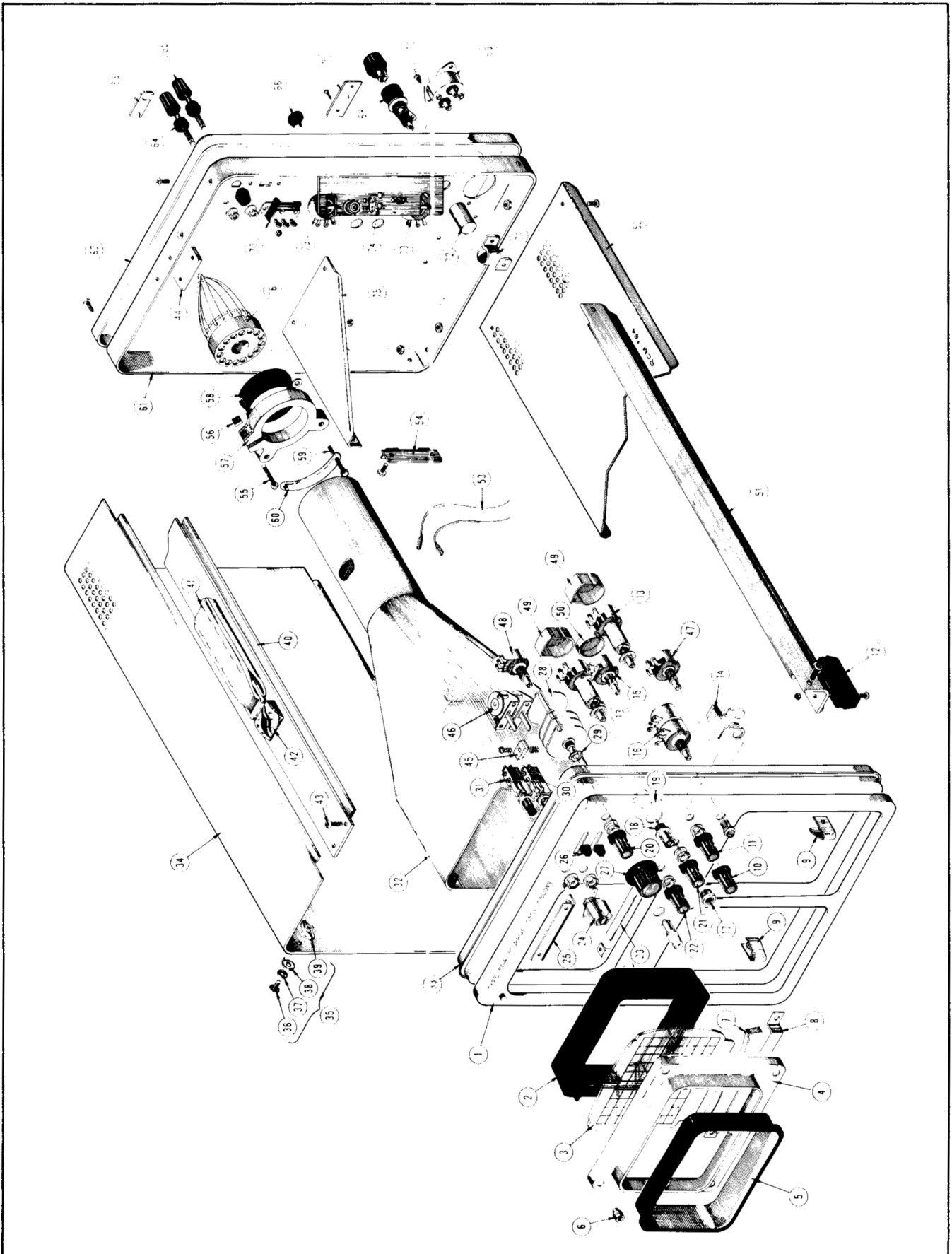

FRONT & REAR

REF. NO.	PART NO.	SERIAL/MODEL NO.		QTY.	DESCRIPTION
		EFF.	DISC.		
1	333-720	101	1999	1	PANEL, front
	333-809	2000		1	PANEL, front
2	354-181			1	RING, cri shockmount
3	331-097			1	GRATICULE
4	200-426			1	COVER, trim and graticule, assembly (See Ref. #6)
	- - - -			-	cover includes:
5	101-006			1	TRIM, graticule cover
	- - - -			-	mounting hardware: (not included w/cover)
6	210-571			4	NUT, graticule cover
7	337-540			1	SHIELD, reflector
8	352-049			1	HOLDER, reflector shield
9	344-095			2	CLIP, grounding
10	366-148	101	2079	1	KNOB, charcoal—SCALE ILLUM.
	- - - -			-	knob includes:
	213-004			1	SCREW, set, 6-32 x $\frac{3}{16}$ inch, HSS
	366-220	2080		1	KNOB, charcoal—SCALE ILLUM.
	- - - -			-	knob includes:
	213-020			1	SCREW, set, 6-32 x $\frac{1}{8}$ inch, HSS
11	366-148	101	2239	1	KNOB, charcoal—INTENSITY
	- - - -			-	knob includes:
	213-004			1	SCREW, set, 6-32 x $\frac{3}{16}$ inch, HSS
	366-220	2240		1	KNOB, charcoal—INTENSITY
	- - - -			-	knob includes:
	213-020			1	SCREW, set, 6-32 x $\frac{1}{8}$ inch, HSS
12	348-042	101	3999	4	FOOT, molded gray
	348-052	4000		4	FOOT, molded, anti-slide
	- - - -			-	mounting hardware for each: (not included w/foot)
	212-071			2	SCREW, 8-32 x 1 inch, FHS
	210-458			2	NUT, keps, 8-32 x $\frac{1}{32}$ inch
13	- - - -			2	POT
	- - - -			-	mounting hardware for each: (not included w/pot)
	210-013			1	LOCKWASHER, internal, $\frac{3}{8}$ x $\frac{11}{16}$ inch
	210-840	101	2239	1	WASHER, .390 ID x $\frac{9}{16}$ inch OD
	210-978	2240		1	WASHER, $\frac{3}{8}$ ID x $\frac{1}{2}$ inch OD
	210-413	101	2239	1	NUT, hex, $\frac{3}{8}$ -32 x $\frac{1}{2}$ inch
	210-590	2240		1	NUT, hex, $\frac{3}{8}$ -32 x $\frac{7}{16}$ inch
14	136-047			1	SOCKET, light, w/red jewel
15	- - - -			1	POT
	- - - -			-	mounting hardware: (not included w/pot)
	210-207			1	LUG, sokler, $\frac{3}{8}$ inch
	210-012			1	LOCKWASHER, internal, $\frac{3}{8}$ x $\frac{1}{2}$ inch
	210-840	101	2239	1	WASHER, .390 ID x $\frac{9}{16}$ inch OD
	210-978	2240		1	WASHER, $\frac{3}{8}$ ID x $\frac{1}{2}$ inch OD
	210-413	101	2239	1	NUT, hex, $\frac{3}{8}$ -32 x $\frac{1}{2}$ inch
	210-590	2240		1	NUT, hex, $\frac{3}{8}$ -32 x $\frac{7}{16}$ inch

FRONT & REAR (Cont'd)

REF. NO.	PART NO.	SERIAL/MODEL NO.		QTY.	DESCRIPTION
		EFF.	DISC.		
16	- - - -			1	POT
	- - - -			-	mounting hardware: (not included w/pot)
	210-207			1	LUG, solder, 3/8 inch
	210-012			1	LOCKWASHER, internal, 3/8 x 1/2 inch
	210-494			1	NUT, hex, 3/8-32 x 1/2 x 1 1/16 inch
	210-013			1	LOCKWASHER, internal, 3/8 x 1 1/16 inch
17	358-010			1	BUSHING, aluminum
18	131-064	101	319	1	CONNECTOR, coaxial, UFH
	131-279	320	1999	1	CONNECTOR, BNC
	- - - -			-	mounting hardware: (not included w/connector)
	210-224	101	1999X	1	LUG, solder, #10
	210-812	101	1999X	2	WASHER, fiber, #10
	210-004	101	1999X	2	LOCKWASHER, internal, #4
	210-406	101	1999X	2	NUT, hex, 4-40 x 3/16 inch
	131-274	2000		1	CONNECTOR, BNC
19	406-244	101	1999X	1	BRACKET, coaxial insulator
20	366-220	X2000		1	KNOB, charcoal—WRITING RATE INCREASE
	- - - -			-	knob includes:
	213-020			1	SCREW, set, 6-32 x 1/8 inch, HSS
21	366-148	101	2239	1	KNOB, charcoal—ASTIGMATISM
	- - - -			-	knob includes:
	213-004			1	SCREW, set, 6-32 x 3/16 inch, HSS
	366-220	2240		1	KNOB, charcoal—ASTIGMATISM
	- - - -			-	knob includes:
	213-020			1	SCREW, set, 6-32 x 1/8 inch, HSS
22	366-148	101	2239	1	KNOB, charcoal—FOCUS
	- - - -			-	knob includes:
	213-004			1	SCREW, set, 6-32 x 3/16 inch, HSS
	366-220	2240		1	KNOB, charcoal—FOCUS
	- - - -			-	knob includes:
	213-020			1	SCREW, set, 6-32 x 1/8 inch, HSS
23	406-875			1	BRACKET, bottom, crt shield
	- - - -			-	mounting hardware (not included w/ bracket)
	211-538			2	SCREW, 6-32 x 5/16 inch, FHS phillips
24	136-152			2	SOCKET, lamp
25	406-877			1	BRACKET, top, crt shield
	- - - -			-	mounting hardware: (not included w/bracket)
	211-538			2	SCREW, 6-32 x 5/16 inch, FHS phillips
26	366-215			2	KNOB, lever
27	366-117			1	KNOB, large charcoal—CALIBRATOR
	- - - -			-	knob includes:
	213-004			1	SCREW, set, 6-32 x 3/16 inch, HSS

FRONT & REAR (Cont'd)

REF. NO.	PART NO.	SERIAL/MODEL NO.		QTY.	DESCRIPTION
		EFF.	DISC.		
28	262-497			1	SWITCH, wired—CALIBRATOR (See Ref. #29)
	- - - -				switch includes:
	260-253			1	SWITCH, unwired—CALIBRATOR
	210-207			1	LUG, solder, $\frac{3}{8}$ inch
29	- - - -				mounting hardware: (not included w/switch)
	210-012			1	LOCKWASHER, internal, $\frac{3}{8} \times \frac{1}{2}$ inch
	210-840			1	WASHER, .390 ID x $\frac{9}{16}$ inch OD
	210-413			1	NUT, hex, $\frac{3}{8}$ -32 x $\frac{1}{2}$ inch
30	260-507	101	1999	1	SWITCH, push—INTEGRATE
	260-508	2000	2355	1	SWITCH, push—INTEGRATE
	260-602	2356	3470	1	SWITCH, push—INTEGRATE
	260-645	3471		1	SWITCH, push—INTEGRATE
	- - - -				mounting hardware: (not included w/switch)
	210-012			1	LOCKWASHER, internal, $\frac{3}{8} \times \frac{1}{2}$ inch
	210-840			1	WASHER, .390 ID x $\frac{9}{16}$ inch OD
	210-413			1	NUT, hex, $\frac{3}{8}$ -32 x $\frac{1}{2}$ inch
31	260-508	101	1999	1	SWITCH, push—LOCATE
	260-602	2000	3470	1	SWITCH, push—LOCATE
	260-645	3471		1	SWITCH, push—LOCATE
	- - - -				mounting hardware: (not included w/switch)
	210-012			1	LOCKWASHER, internal, $\frac{3}{8} \times \frac{1}{2}$ inch
	210-840			1	WASHER, .390 ID x $\frac{9}{16}$ inch OD
	210-413			1	NUT, hex, $\frac{3}{8}$ -32 x $\frac{1}{2}$ inch
32	337-551			1	SHIELD, crt
	- - - -				mounting hardware: (not included w/shield)
	211-504			4	SCREW, ϵ -32 x $\frac{1}{4}$ inch, BHS
	211-507			1	SCREW, ϵ -32 x $\frac{5}{16}$ inch, BHS
	210-803			1	WASHER, 6L x $\frac{3}{8}$ inch
33	387-724	101	1999	1	PLATE, front sub-panel
	387-920	2000		1	PLATE, front sub-panel
	- - - -				plate includes:
	354-057			1	RING, ornamental
34	387-725			2	PLATE, cabinet side
	- - - -				each plate includes:
35	214-057			2	FASTENER, cabinet latch assembly
	- - - -				each fastener includes:
36	213-033			1	SCREW, fastening
37	210-847			1	WASHER, nylon, .164 ID x .500 inch OD
38	105-007			1	STOP
39	210-480			1	NUT, latch, nylon

FRONT & REAR (Cont'd)

REF. NO.	PART NO.	SERIAL/MODEL NO.		QTY.	DESCRIPTION
		EFF.	DISC.		
40	381-213			1	BAR, top support, w/handle (See Ref. #43 & #44)
	- - - -			-	bar includes:
41	367-040			1	HANDLE ASSEMBLY
	- - - -			-	handle assembly includes:
	367-011			1	HANDLE
42	343-073			2	CLAMP, handle
	211-507			4	SCREW, 6-32 x 5/16 inch, BHS
	210-457			4	NUT, keps, 6-32 x 5/16 inch
	- - - -			-	mounting hardware: (not included w/bar)
43	212-039			4	SCREW, 8-32 x 3/8 inch, THS phillips
44	381-073			2	BAR, retaining
45	352-044			1	HOLDER, crt coil form
	- - - -			-	mounting hardware: (not included w/holder)
	211-011			1	SCREW, 4-40 x 5/16 inch BHS
	210-004			1	LOCKWASHER, internal, #4
	210-406			1	NUT, hex 4-40 x 3/16 inch
46	260-510			2	SWITCH, lever—DISPLAY STORE
	- - - -			-	mounting hardware for each: (not included w/switch)
	210-004			2	LOCKWASHER, internal, #4
	210-406			2	NUT, hex 4-40 x 3/16 inch
47	- - - -			1	POT
	- - - -			-	mounting hardware: (not included w/pot)
	210-013			1	LOCKWASHER, internal, 3/8 x 1 1/16 inch
	210-840	101	2079	1	WASHER, .390 ID x 9/16 inch OD
	210-978	2080		1	WASHER, 3/8 ID x 1/2 inch OD
	210-413	101	2079	1	NUT, hex 3/8-32 x 1/2 inch
	210-590	2080		1	NUT, hex 3/8-32 x 7/16 inch
48	- - - -	X2000		1	POT
	- - - -			-	mounting hardware: (not included w/pot)
	210-207			1	LUG, solder, 3/8 inch
	210-012			1	LOCKWASHER, internal, 3/8 x 1/2 inch
	210-978			1	WASHER, 3/8 ID x 1/2 inch OD
	210-590			1	NUT, hex 3/8-32 x 7/16 inch
49	200-269			2	COVER, pot
50	200-247			1	CAP, pot
51	122-107			2	ANGLE, frame
	- - - -			-	mounting hardware for each: (not included w/angle)
	212-039			4	SCREW, 8-32 x 3/8 inch, THS phillips
	210-458			4	NUT, keps, 8-32 x 1 1/32 inch

FRONT & REAR (Cont'd)

REF. NO.	PART NO.	SERIAL/MODEL NO.		QTY.	DESCRIPTION
		EFF.	DISC.		
52	387-732			1	PLATE, bottom
	- - - -			-	mounting hardware: (not included w/plate)
	212-039			8	SCREW, 8-32 x 3/8 inch, THS phillips
53	175-583			1	WIRE, crt lead, 11 1/2 inches, striped red, w/connector
	175-584			1	WIRE, crt lead, 11 1/2 inches, striped green, w/connector
	175-588			1	WIRE, crt lead, .833 foot, striped orange, w/connector
	175-641			1	WIRE, crt lead, .833 foot, striped brown, w/connector
	175-642			1	WIRE, crt lead, .833 foot, striped blue, w/connector
54	406-878			1	BRACKET, crt
	- - - -			-	mounting hardware: (not included w/bracket)
	211-507			2	SCREW, 6-32 x 5/16 inch, BHS
55	211-560			1	SCREW, 6-32 x 1 inch, RHS
56	220-419			1	NUT, square, 6-32 x 5/16 inch
57	354-147	101	599	1	RING, clamping (See Ref. #59 & #60)
	354-212	600		1	RING, crt clamping, assembly (See Ref. #59 & #60)
	- - - -			-	ring assembly includes:
58	124-160	X600		1	STRIP, liner
	- - - -			-	mounting hardware: (not included w/ring)
59	211-517			2	SCREW, 6-32 x 1 inch, BHS
	210-949			2	WASHER, 9/64 ID x 1/2 inch OD
	210-457			2	NUT, keps., 6-32 x 5/16 inch
60	214-207			1	NUT, adjusting, securing
61	387-727			1	PLATE, rear sub-panel
	- - - -			-	plate includes:
	354-057			1	RING, ornamental
62	387-729			1	PLATE, rear overlay
	- - - -			-	mounting hardware: (not included w/plate)
	213-104			2	SCREW, thread forming, 6-32 x 3/8 inch, THS phillips
63	386-427			1	PLATE, ground
64	129-063			1	POST, binding
	- - - -			-	mounting hardware: (not included w/post)
	220-410			1	NUT, keps., 10-32 x 3/8 inch
65	129-063			1	POST, binding
	- - - -			-	mounting hardware: (not included w/post)
	358-169			1	BUSHING, binding post
	220-410			1	NUT, keps., 10-32 x 3/8 inch
66	134-067			4	PLUG, "D" hole
67	334-661			1	TAG, voltage rating
	- - - -			-	mounting hardware: (not included w/tag)
	213-088			2	SCREW, thread forming, 4-40 x 1/4 inch, PHS phillips

FRONT & REAR (Cont'd)

REF. NO.	PART NO.	SERIAL/MODEL NO.		QTY.	DESCRIPTION
		EFF.	DISC.		
68	352-002			1	HOLDER, fuse, assembly
	- - - -				holder assembly includes:
	352-010			1	HOLDER, fuse
	200-582			1	CAP, fuse
	210-873			1	WASHER, rubber, 1/2 ID x 1 1/16 inch OD
	- - - -			1	NUT, fuse holder
69	131-150			1	CONNECTOR, motor base (See Ref. #70)
	- - - -				connector includes:
	129-041			1	POST, ground, 4-40 thread one end
	200-185			1	COVER, 3 wire motor base
	205-014			1	SHELL, mounting
	210-003			2	LOCKWASHER, external, #4
	210-551			2	NUT, hex, 4-40 x 1/4 inch
	211-015			1	SCREW, 4-40 x 1/2 inch, RHS
	214-078			2	PIN, connecting
	377-041			1	INSERT, black urea
70	- - - -				mounting hardware: (not included w/connector)
	213-104			2	SCREW, thread forming, 6-32 x 3/8 inch, THS phillips
71	343-008			1	CLAMP, cable, 3/4 inch
	- - - -				mounting hardware: (not included w/clamp)
	210-863			1	WASHER, "D" type
	210-006			1	LOCKWASHER, internal, #6
	210-407			1	NUT, hex, 6-32 x 1/4 inch
72	200-237	101	2239X	1	COVER, insulating, fuse holder
73	- - - -			2	POT
	- - - -				mounting hardware for each: (not included w/pot)
	210-012			1	LOCKWASHER, internal, 3/8 x 1/2 inch
	210-840			1	WASHER, .390 ID x 9/16 inch OD
	210-413			1	NUT, hex, 3/8-32 x 1/2 inch
74	- - - -			1	TRANSISTOR
	- - - -				mounting hardware: (not included w/transistor)
	211-510			2	SCREW, 6-32 x 3/8 inch, BHS
	210-006			1	LOCKWASHER, internal, #6
	210-202			1	LUG, solder, SE #6
	210-407			2	NUT, hex, 6-32 x 1/4 inch
75	387-726			1	PLATE, gusset, rear sub-panel
	- - - -				mounting hardware: (not included w/plate)
	211-538			2	SCREW, 6-32 x 5/16 inch, FHS phillips
	210-457			2	NUT, keps, 6-32 x 5/16 inch
76	- - - -				SUBPARTS OF CRT CABLE HARNESS
	- - - -				(see cable harness & ceramic strip detail, page 6-16)

FRONT & REAR (Cont'd)

REF. NO.	PART NO.	SERIAL/MODEL NO.		QTY.	DESCRIPTION
		EFF.	DISC.		
77	260-449 - - - - 210-406			1 - 2	SWITCH, slide—CRT CATHODE SELECTOR mounting hardware: (not included w/switch) NUT _x hex, 4-40 x 3/16 inch

CHASSIS

REF. NO.	PART NO.	SERIAL/MODEL NO.		QTY.	DESCRIPTION
		EFF.	DISC.		
1	406-879 - - - - 211-538 211-541 212-039 210-458			1 - 2 3 1 1	BRACKET, plug-in housing, left mounting hardware: (not included w/bracket) SCREW, 6-32 x 5/16 inch, FHS phillips SCREW, 6-32 x 1/4 inch, FHS phillips SCREW, 8-32 x 3/8 inch, THS phillips NUT, keps, 8-32 x 1 1/32 inch
2	384-611			1	ROD, spacer
3	351-038 - - - - 211-541			2 - 2	GUIDE, rail track, plug-in mounting hardware for each: (not included w/guide) SCREW, 6-32 x 1/4 inch, FHS phillips
4	406-880 - - - - 211-538 211-559 210-457 212-039 210-458			1 - 5 3 3 1 1	BRACKET, plug-in housing, right mounting hardware: (not included w/bracket) SCREW, 6-32 x 5/16 inch, FHS phillips SCREW, 6-32 x 3/8 inch, FHS phillips NUT, keps 6-32 x 5/16 inch SCREW, 8-32 x 3/8 inch, THS phillips NUT, keps 8-32 x 1 1/32 inch
5	343-006 - - - - 211-559 210-803 210-457			2 - 1 1 1	CLAMP, cable, 1/2 inch mounting hardware for each: (not included w/clamp) SCREW, 6-32 x 3/8 inch, FHS phillips WASHER, 6L x 3/8 inch NUT, keps 6-32 x 5/16 inch
6	136-015 - - - - 213-044			6 - 2	SOCKET, STM9G mounting hardware for each: (not included w/socket) SCREW, thread cutting, 5-32 x 3/16 inch, PHS phillips
7	- - - - - - - - 213-012			1 - 1	COIL mounting hardware: (not included w/coil) SCREW, thread cutting, 4-40 x 3/8 inch, FHS
8	352-015 - - - - 213-045			2 - 1	HOLDER, coil form mounting hardware for each: (not included w/holder) SCREW, self-tapping, 4-40 x 5/16 inch, PHS phillips
9	210-201 - - - - 213-044			3 - 1	LUG, solder, SE #4 mounting hardware for each: (not included w/lug) SCREW, thread cutting, 5-32 x 3/16 inch, PHS phillips
10	- - - - - - - - 210-940 210-583			3 - 1 1	POT mounting hardware for each: (not included w/pot) WASHER, 400 OD x .261 inch ID NUT, hex, 1/4-32 x 5/16 inch
11	406-893 - - - - 211-507			1 - 2	BRACKET, pot mounting mounting hardware: (not included w/bracket) SCREW, 6-32 x 5/16 inch, BHS

CHASSIS (Cont'd)

REF. NO.	PART NO.	SERIAL/MODEL NO.		QTY.	DESCRIPTION
		EFF.	DISC.		
12	131-148			2	CONNECTOR, 24 contact
	- - - -			-	mounting hardware for each: (not included w/connector)
	211-014			2	SCREW, 4-40 x 1/2 inch, BHS
	166-029			2	TUBE, spacer
	210-004			2	LOCKWASHER, internal, #4
	210-406			2	NUT, hex, 4-40 x 3/16 inch
13	214-210			1	SPOOL, solder, assembly
	- - - -			-	spool assembly includes:
	214-209			1	SPOOL, solder
	- - - -			-	mounting hardware: (not included w/spool)
	361-007			1	SPACER, nylon, .063 inch
14	343-001			1	CLAMP, cable, 1/8 inch
	- - - -			-	mounting hardware: (not included w/clamp)
	211-510			1	SCREW, 6-32 x 3/8 inch, BHS
	210-863			1	WASHER, "D" type
15	337-529			1	SHIELD, high voltage
	- - - -			-	mounting hardware: (not included w/shield)
	211-507			2	SCREW, 6-32 x 5/16 inch, BHS
16	136-013			1	SOCKET, STM8
	- - - -			-	mounting hardware: (not included w/socket)
	211-541			2	SCREW, 6-32 x 1/4 inch, FHS phillips
	210-006			2	LOCKWASHER, internal, #6
	210-407			2	NUT, hex, 6-32 x 1/4 inch
17	136-008			3	SOCKET, STM7G
	- - - -			-	mounting hardware for each: (not included w/socket)
	213-044			2	SCREW, thread cutting, 5-32 x 3/16 inch, PHS phillips
18	- - - -			1	TRANSFORMER
	- - - -			-	mounting hardware: (not included w/transformer)
	212-522			4	SCREW, 10-32 x 2 1/2 inches, HHS
	210-812			4	WASHER, fiber, #10
	220-410			4	NUT, keps, 10-32 x 3/8 inch
19	406-881			1	BRACKET, transformer strip mounting
20	348-003			2	GROMMET, 5/16 inch
21	348-006			1	GROMMET, 1/4 inch
22	343-074			1	CLAMP, tube
	- - - -			-	mounting hardware: (not included w/clamp)
23	355-070			1	STUD, 8-32 x 4 3/4 inches
	210-008			2	LOCKWASHER, internal, #8
	210-409			2	NUT, hex, 8-32 x 5/16 inch

CHASSIS (Cont'd)

REF. NO.	PART NO.	SERIAL/MODEL NO.		QTY.	DESCRIPTION
		EFF.	DISC.		
24	385-097 - - - - 211-507			2 - 1	ROD, nylon mounting hardware for each: (not included w/rod) SCREW, 6-32 x 5/16 inch, BHS
25	385-124 - - - - 211-507 210-006			1 - 1 1	ROD, support, high voltage shield mounting hardware: (not included w/rod) SCREW, 6-32 x 5/16 inch, BHS LOCKWASHER, internal, #6
26	441-463 - - - - 211-538 212-040 212-023			1 - 3 4 3	CHASSIS, aluminum mounting hardware: (not included w/chassis) SCREW, 6-32 x 5/16 inch, FHS phillips SCREW, 8-32 x 3/8 inch, FHS phillips SCREW, 8-32 x 3/8 inch, BHS
27	- - - - - - - - 212-037 210-808 210-462 212-004			3 - 1 1 1 1	RESISTOR, 20 watt mounting hardware for each: (not included w/resistor) SCREW, 8-32 x 1 3/4 inches, Fil HS WASHER, resistor centering NUT, hex, resistor mounting SCREW, 8-32 x 5/16 inch, BHS
28	348-012 358-215	101 4041	4040	1 1	GROMMET, 5/8 inch BUSHING, plastic
29	346-001 - - - - 210-004 210-406			1 - 2 2	STRAP, mounting, high voltage transformer mounting hardware: (not included w/strap) LOCKWASHER, internal, #4 NUT, hex, 4-40 x 3/16 inch
30	136-095 136-181 - - - - 213-113 354-234	101 2980 101 2980	2979 2979	3 3 - 2 1	SOCKET, 4 pin transistor SOCKET, 4 pin transistor mounting hardware for each: (not included w/socket) SCREW, thread forming, 2-32 x 5/16 inch, RHS phillips RING, locking, transistor socket
31	385-137 - - - - 213-041			1 - 1	ROD, delrin mounting hardware: (not included w/rod) SCREW, thread cutting, 6-32 x 3/8 inch, THS phillips
32	348-031			2	GROMMET, snap-in
33	260-157 - - - - 213-044			1 - 2	SWITCH, thermal cut-out mounting hardware: (not included w/switch) SCREW, thread cutting, 5-32 x 3/16 inch, PHS phillips
34	210-952			1	WASHER, insulating, 1.440 OD x .900 inch ID (not shown)
35	352-031 - - - - 211-510 210-006 210-407			1 1 - 1 1 1	HOLDER, fuse, single mounting hardware: (not included w/holder) SCREW, 6-32 x 3/8 inch, BHS LOCKWASHER, internal, #6 NUT, hex, 6-32 x 1/4 inch

CHASSIS (Cont'd)

REF. NO.	PART NO.	SERIAL/MODEL NO.		QTY.	DESCRIPTION
		EFF.	DISC.		
36	348-004	X2000		1	GROMMET, 3/8 inch
37	441-464			1	CHASSIS, calibrator
	- - - -			-	mounting hardware: (not included w/chassis)
	211-510			1	SCREW, 6-32 x 3/8 inch, BHS
	211-507			5	SCREW, 6-32 x 5/16 inch, BHS
	210-803			5	WASHER, 6L x 3/8 inch
38	348-004			1	GROMMET, 3/8 inch
39	- - - -			3	POT
	- - - -			-	mounting hardware for each: (not included w/pot)
	210-013			1	LOCKWASHER, internal, 3/8 x 1 1/16 inch
	210-840			1	WASHER, 390 ID x 3/16 inch OD
	210-413			1	NUT, hex, 3/8-32 x 1/2 inch
40	- - - -	X2000		1	POT
	- - - -			-	mounting hardware: (not included w/pot)
	210-046			1	LOCKWASHER, internal, .400 OD x .261 inch ID
	210-223			1	LUG, solder, 1/4 inch
	210-583			1	NUT, hex, 1/4-32 x 5/16 inch
41	- - - -			4	POT
	- - - -			-	mounting hardware for each: (not included w/pot)
	210-046			1	LOCKWASHER, internal, .400 OD x .261 inch ID
	210-940			1	WASHER, 1/4 ID x 3/8 inch OD
	210-583			1	NUT, hex, 1/4-32 x 5/16 inch
42	- - - -			1	POT
	- - - -			-	mounting hardware: (not included w/pot)
	210-223			1	LUG, solder, 1/4 inch
	210-940			1	WASHER, 1/4 ID x 3/8 inch OD
	210-583			1	NUT, hex, 1/4-32 x 5/16 inch
43	386-252			1	PLATE, fiber, small capacitor
	- - - -			-	mounting hardware: (not included w/plate)
	211-534			2	SCREW, 6-32 x 5/16 inch, PHS w/lockwasher
	210-006			2	LOCKWASHER, internal, #6
	210-407			2	NUT, hex, 6-32 x 1/4 inch
44	200-256			1	COVER, capacitor, 2 1/32 inches
45	432-044	101	2979	2	BASE, large capacitor
	432-048	2980		2	BASE, large capacitor
46	386-254			2	PLATE, fiber, large capacitor
	- - - -			-	mounting hardware for each: (not included w/plate)
	211-532			2	SCREW, 6-32 x 3/4 inch, Fil HS
47	200-261			1	COVER, capacitor, 4 1/16 inches
48	136-161	X2000	2979	2	SOCKET, 4 pin transistor
	136-181	2980		2	SOCKET, 4 pin transistor
	- - - -			-	mounting hardware for each: (not included w/socket)
	213-113	X2000	2979	2	SCREW, thread forming, 2-32 x 5/16 inch, RHS phillips
	354-234	2980		1	RING, locking, transistor socket

CHASSIS (Cont'd)

REF. NO.	PART NO.	SERIAL/MODEL NO.		QTY.	DESCRIPTION
		EFF.	DISC.		
49	337-649	X2980		1	SHIELD, heat dissipating
50	386-255			1	PLATE, metal, large capacitor
	- - - -			-	mounting hardware: (not included w/plate)
	211-534	101	2979	2	SCREW, 6-32 x $\frac{5}{16}$ inch, PHS w/lockwasher
	211-532	2980		2	SCREW, 6-32 x $\frac{3}{4}$ inch, Fil HS
51	432-048	X2980		1	BASE, large capacitor
52	200-293	101	2979	1	COVER, capacitor, $2\frac{9}{16}$ inches
	200-258	2980		1	COVER, capacitor, $3\frac{1}{32}$ inches
53	200-259	101	2979	1	COVER, capacitor, $3\frac{9}{16}$ inches
	200-258	2980		1	COVER, capacitor, $3\frac{1}{32}$ inches

CABLE HARNESS & CERAMIC STRIP DETAIL

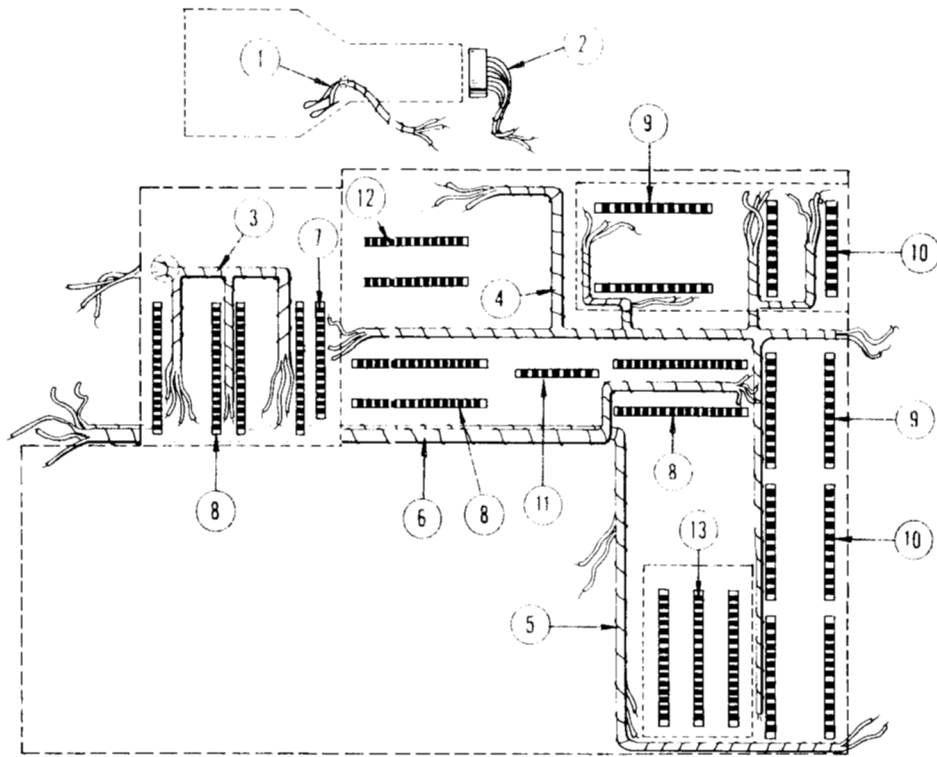

REF. NO.	PART NO.	SERIAL/MODEL NO.		QTY.	DESCRIPTION
		EFF.	DISC.		
1	179-705	101	3309	1	CABLE HARNESS, 5 pin connector
	131-362	3310		1	CONNECTOR, wall band assembly
2	179-704			1	CABLE HARNESS, crt
	- - - -			-	cable harness includes:
	136-147	101	1059	1	SOCKET, crt assembly
	136-179	1060		1	SOCKET, crt, assembly
	- - - -			-	socket assembly includes:
	131-178			14	CONNECTOR, cable end, crt
	136-117			1	SOCKET, crt
	387-393			1	PLATE, back
	213-086			2	SCREW, thread cutting, 2-32 x 7/16 inch, PHS
	3	179-692	101	1999	1
179-877		2000	2709	1	CABLE HARNESS, calibrator
179-933		2710		1	CABLE HARNESS, calibrator
4	179-689	101	1999	1	CABLE HARNESS, power
	179-878	2000		1	CABLE HARNESS, power
5	179-690			1	CABLE HARNESS, 110 volt
6	179-691	101	1999	1	CABLE HARNESS, focus and intensity
	179-879	2000		1	CABLE HARNESS, focus and intensity

CABLE HARNESS & CERAMIC STRIP DETAIL (Cont'd)

REF. NO.	PART NO.	SERIAL/MODEL NO.		QTY.	DESCRIPTION
		EFF.	DISC.		
7	124-155 - - - - 355-082 - - - - 361-039			1 - 2 - 2	STRIP, ceramic, 7/16 inch x 16 notches strip includes: STUD, nylon mounting hardware: (not included w/strip) SPACER, nylon, 13/32 inch
8	124-154 - - - - 355-082 - - - - 361-039			8 - 2 - 2	STRIP, ceramic, 7/16 inch x 20 notches each strip includes: STUD, nylon mounting hardware for each: (not included w/strip) SPACER, nylon, 13/32 inch
9	124-091 - - - - 355-046 - - - - 361-009			4 - 2 - 2	STRIP, ceramic, 3/4 inch x 11 notches each strip includes: STUD, nylon mounting hardware for each: (not included w/strip) SPACER, nylon, .313 inch
10	124-090 - - - - 355-046 - - - - 361-009			6 - 2 - 2	STRIP, ceramic, 3/4 inch x 9 notches each strip includes: STUD, nylon mounting hardware for each: (not included w/strip) SPACER, nylon, .313 inch
11	124-158 - - - - 355-082 - - - - 361-039			1 - 2 - 2	STRIP, ceramic, 7/16 inch x 7 notches strip includes: STUD, nylon mounting hardware: (not included w/strip) SPACER, nylon, 13/32 inch
12	124-147 - - - - 355-046 - - - - 361-008	X2000		2 - 2 - 2	STRIP, ceramic, 7/16 inch x 13 notches each strip includes: STUD, nylon mounting hardware for each: (not included w/strip) SPACER, nylon, .188 inch
13	124-145 - - - - 355-046 - - - - 361-009 361-008			3 - 2 - 2 2	STRIP, ceramic, 7/16 inch x 20 notches each strip includes: STUD, nylon mounting hardware for each: (not included w/strip) SPACER, nylon, .313 inch SPACER, nylon, .188 inch
		101 2860	2859		

ACCESSORIES

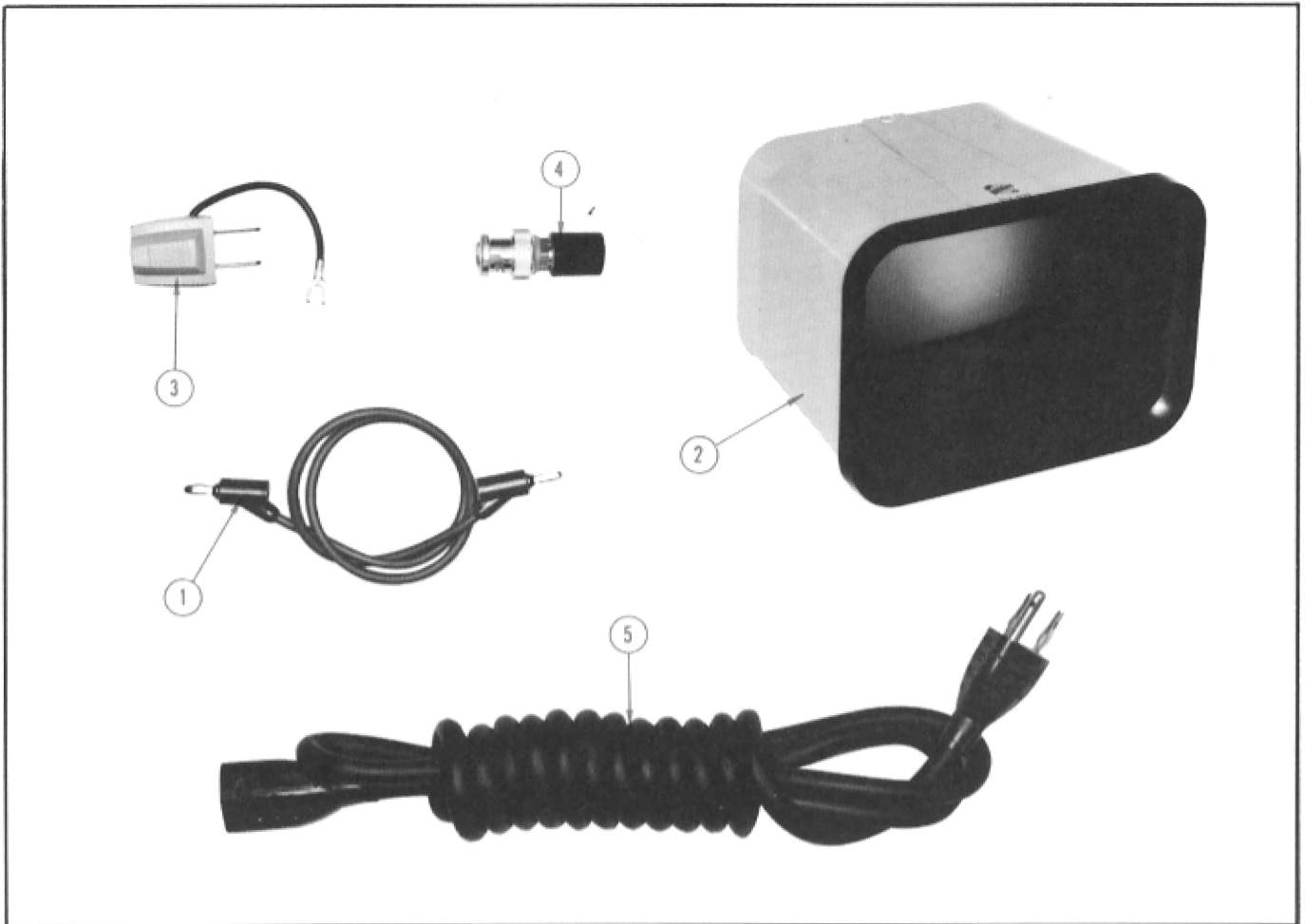

REF. NO.	PART NO.	SERIAL/MODEL NO.		QTY.	DESCRIPTION
		EFF.	DISC.		
1	012-031	X2000		1	CORD, patch-banana
2	016-039			1	VIEWER, polarized, assembly
3	103-013			1	ADAPTER, power cord
4	103-033	X2000		2	ADAPTER, BNC to binding post
5	161-010			1	CORD, power

ELECTRICAL PARTS LIST

Values are fixed unless marked Variable.

Ckt. No.	Tektronix Part No.	Description	S/N Range
BULBS			
B601	150-001	Incandescent, G.E. #47	Graticule Light
B602	150-001	Incandescent, G.E. #47	Graticule Light
B603	150-018	Incandescent, G.E. #12	Pilot Light
B856	150-025	Neon, NE-2E	
B857	150-025	Neon, NE-2E	
B903	150-028	Neon, RT 2-32 1A	

CAPACITORS

Tolerance $\pm 20\%$ unless otherwise indicated.

Tolerance of all electrolytic capacitors are as follows (with exceptions):

3 V — 50 V = -10% , $+250\%$ 51 V — 350 V = -10% , $+100\%$ 351 V — 450 V = -10% , $+ 50\%$

C611	285-510	.01 μf	MT	400 v	
C616	285-510	.01 μf	MT	400 v	
C640A,B	Use *290-228	340 μf x 10 μf	EMC	250 v	
C642A,B,	Use *290-227	340 μf x 10 μf	EMC	250 v	
C644	Use *290-228	340 μf x 10 μf	EMC	250 v	
C646	*290-040	2 x 40 μf	EMC	250 v	
C650	285-510	.01 μf	MT	400 v	
C667	290-002	8 μf	EMT	450 v	
C670	285-510	.01 μf	MT	400 v	
C720	290-166	2 x 2000 μf	EMC	25 v	
C732	Use 290-201	100 μf	EMT	15 v	
C737	283-026	.2 μf	Disc Type	25 v	
C757	290-015	100 μf	EMT	25 v	
C760	281-027	.7-3 pf	Tub.	Var.	
C761	281-027	.7-3 pf	Tub.	Var.	
C762	283-003	.01 μf	Disc Type	150 v	
C801	283-006	.02 μf	Disc Type	600 v	
C803	283-000	.001 μf	Disc Type	500 v	
C807	285-502	.001 μf	MT	1000 v	
C822	283-071	.0068 μf	Disc Type	5000 v	
C830	283-036	.0025 μf	Disc Type	6000 v	101-2979
C830	283-071	.0068 μf	Disc Type	5000 v	2980-up
C832	283-036	.0025 μf	Disc Type	6000 v	101-2979
C832	283-071	.0068 μf	Disc Type	5000 v	2980-up
C837	283-036	.0025 μf	Disc Type	6000 v	101-2979
C837	283-034	.005 μf	Disc Type	4000 v	2980-up
C841	285-519	.047 μf	MT	400 v	
C842	283-071	.0068 μf	Disc Type	5000 v	

Parts List—Type 564

Capacitors (Cont'd)

Ckt. No.	Tektronix Part No.	Description			S/N Range
C849	285-501	.001 μ f	PTM	600 v	
C853	283-036	.0025 μ f	Disc Type	6000 v	101-2979
C853	283-034	.005 μ f	Disc Type	4000 v	2980-up
C876	290-025	6.25 μ f	EMT	300 v	
C878	281-523	100 pf	Cer.	350 v	
C884	281-524	150 pf	Cer.	500 v	
C897	283-000	.001 μ f	Disc Type	500 v	
C904	290-025	6.25 μ f	EMT	500 v	
C913	283-002	.01 μ f	Disc Type	500 v	
C916	285-527	.1 μ f	MFT	600 v	
C918	285-527	.1 μ f	MFT	600 v	
C935	290-164	1 μ f	EMT	150 v	
C945	283-057	.1 μ f	Disc Type	200 v	X2000-up
C947	283-057	.1 μ f	Disc Type	200 v	X2000-up
C949	281-580	470 pf	Cer	500 v	10% X2000-up
C970	281-525	470 pf	Cer	500 v	X2000-up
C985	285-566	.022 μ f	PTM	200 v	10% X2000-3579
	285-629	.047 μ f	PTM	100 v	10% 3580-up

DIODES

D627	*152-107	Silicon	Replaceable by 1N647		X2980-up
D640A,B,C,D,	152-066	Silicon	1N3194		
D642A,B,C,D	152-066	Silicon	1N3194		
D644A,B,C,D,	152-066	Silicon	1N3194		
D646	152-066	Silicon	1N3194		
D720	152-035	Silicon	1N1563A		
D663	*152-107	Silicon	Replaceable by 1N647		X2980-up
D664	*152-107	Silicon	Replaceable by 1N647		X2980-up
D721	152-035	Silicon	1N1563A		
D762	152-008	Germanium	T12G		
D763	152-061	Silicon	Tek Spec		
D838	152-066	Silicon	1N3194		
D839	152-066	Silicon	1N3194		
D849	152-066	Silicon	1N3194		
D908	152-066	Silicon	1N3194		
D911	152-066	Silicon	1N3194		
D916	152-066	Silicon	1N3194		
D918	152-066	Silicon	1N3194		
D920	152-066	Silicon	1N3194		
D926	152-066	Silicon	1N3194		
D935	152-066	Silicon	1N3194		
D937	152-094	Zener	50 v $\frac{3}{4}$ w 10%		
D948	Use *152-107	Silicon	Replaceable by 1N647		X2000-up
D971	152-141	Silicon	1N3605		X2000-up
D972	152-141	Silicon	1N3605		X2000-up
D973	152-141	Silicon	1N3605		X2000-3579
	*152-061	Silicon	Tek Spec		3580-up

FUSES

Ckt. No.	Tektronix Part No.	Description	S/N Range
F601	159-005	3 Amp 3AG Slo-Blo 117 v oper. 50 & 60 cycle	
F601	159-003	1.6 Amp 3AG Slo-Blo 234 v oper. 50 & 60 cycle	
F720	159-023	2 Amp. 3AG Slo-Blo	

INDUCTORS

L860	Use *108-285	Beam Rotator
L948	*108-054	6.4 μ h

RESISTORS

Resistors are fixed, composition, $\pm 10\%$ unless otherwise indicated.

R601†	311-340	50 Ω	Var.	WW	SCALE ILLUM.
R602	308-142	30 Ω	3 w	WW	5%
R609	302-106	10 meg	$\frac{1}{2}$ w		
R610	302-104	100 k	$\frac{1}{2}$ w		
R611	302-102	1 k	$\frac{1}{2}$ w		
R612	302-272	2.7 k	$\frac{1}{2}$ w	Var.	—100 VOLTS
R616	311-015	10 k		WW	1%
R617	308-186	80 k	$\frac{1}{2}$ w	WW	1%
R618	308-226	10 k	$\frac{1}{2}$ w	WW	
R619	302-224	220 k	$\frac{1}{2}$ w		
R624	302-473	47 k	$\frac{1}{2}$ w		
R625	302-222	2.2 k	$\frac{1}{2}$ w		
R626	302-184	180 k	$\frac{1}{2}$ w		
R627	302-102	1 k	$\frac{1}{2}$ w		
R628	308-176	4 k	20 w	WW	5%
R632	302-102	1 k	$\frac{1}{2}$ w		
R633	302-473	47 k	$\frac{1}{2}$ w		
R635	301-302	3 k	$\frac{1}{2}$ w		5%
R639	304-104	100 k	1 w		X2860-up
R640	304-100	10 Ω	1 w		
R642	304-100	10 Ω	1 w		
R644	304-100	10 Ω	1 w		
R646	304-101	100 Ω	1 w		
R650	309-101	330 k	$\frac{1}{2}$ w	Prec.	1%
R651	309-162	250 k	$\frac{1}{2}$ w	Prec.	1%
R652	302-102	1 k	$\frac{1}{2}$ w		
R653	302-225	2.2 meg	$\frac{1}{2}$ w		
R654	302-474	470 k	$\frac{1}{2}$ w		
R655	302-685	6.8 meg	$\frac{1}{2}$ w		
R656	311-068	500 k	.2 w	Var.	+125 VOLTS
R657	302-684	680 k	$\frac{1}{2}$ w		

†Ganged with SW601. Furnished as a unit.

Parts List—Type 564

Resistors (Cont'd)

Ckt. No.	Tektronix Part No.		Description			S/N Range
R658	302-273	27 k	1/2 w			
R659	302-333	33 k	1/2 w			
R663	302-102	1 k	1/2 w			
R664	302-102	1 k	1/2 w			
R666	308-176	4 k	20 w		WW	5%
R667	308-176	4 k	20 w		WW	5%
R670	309-156	1.024 meg	1/2 w		Prec.	1%
R671	309-053	333 k	1/2 w		Prec.	1%
R672	302-102	1 k	1/2 w			
R673	302-105	1 meg	1/2 w			
R675	302-825	8.2 meg	1/2 w			
R676	311-068	500 k	.2 w	Var.		+300 VOLTS
R677	304-224	220 k	1 w			
R678	302-394	390 k	1/2 w			
R679	302-333	33 k	1/2 w			
R729	302-823	82 k	1/2 w			
R730	311-068	500 k	.2 w	Var.		-12.2 VOLTS
R731	309-104	2.05 k	1/2 w		Prec.	1%
R732	310-115	15 k	1 w			1%
R733	301-394	390 k	1/2 w			5%
R734	302-334	330 k	1/2 w			
R735	302-272	2.7 k	1/2 w			
R737	302-151	150 Ω	1/2 w			
R744	308-231	220 Ω	3 w		WW	5%
R754	302-471	470 Ω	1/2 w			
R759	302-104	100 k	1/2 w			
R762	316-473	47 k	1/4 w			
R763	316-105	1 meg	1/4 w			
R764	316-105	1 meg	1/4 w			
R781	316-470	47 Ω	1/4 w			101-2979X
R782	316-470	47 Ω	1/4 w			101-2979X
R783	316-470	47 Ω	1/4 w			101-2979X
R784	316-470	47 Ω	1/4 w			101-2979X
R801	306-681	680 Ω	2 w			
R802	302-562	5.6 k	1/2 w			
R803	306-273	27 k	2 w			
R806	302-104	100 k	1/2 w			
R807	302-472	4.7 k	1/2 w			
R813	302-101	100 Ω	1/2 w			
R815	302-474	470 k	1/2 w			
R816	302-102	1 k	1/2 w			
R831	302-104	100 k	1/2 w			
R832	302-106	10 meg	1/2 w			
R833	311-043	2 meg		Var.		INTENSITY
R834	302-105	1 meg	1/2 w			

Resistors (Cont'd)

Ckt. No.	Tektronix Part No.	Description	S/N Range
R835	Use *050-115	Replacement Kit	101-581
	(3) 306-565	5.6 meg 2 w	
R835†	(2) 306-685	6.8 meg 2 w	582-up
R836	302-223	22 k 1/2 w	
R837	302-471	470 Ω 1/2 w	
R838	301-242	2.4 k 1/2 w	5%
R839	302-104	100 k 1/2 w	
R840	301-125	1.2 meg 1/2 w	5%
R841	311-042	2 meg	Var. HIGH VOLTAGE
R842	Use *050-118	Replacement Kit	101-581
R842††	(2) 306-275	2.7 meg 2 w	
	(2) 306-335	3.3 meg 2 w	582-up
R844	311-121	5 meg	Var. FOCUS
R846	302-225	2.2 meg 1/2 w	
R847	302-103	10 k 1/2 w	
R848	302-334	330 k 1/2 w	
R849	316-336	33 meg 1/4 w	
R850	302-223	22 k 1/2 w	
R851	302-104	100 k 1/2 w	
R852	302-273	27 k 1/2 w	
R853	302-471	470 Ω 1/2 w	
R854	302-105	1 meg 1/2 w	
R860	311-317	2 x 1 k	Var. TRACE ALIGNMENT
R861	302-680	68 Ω 1/2 w	
R864	311-206	250 k	Var. ASTIGMATISM
R865	316-472	4.7 k 1/4 w	
R867	316-472	4.7 k 1/4 w	
R868	316-472	4.7 k 1/4 w	
R869	302-564	560 k 1/2 w	
R870	301-393	39 k 1/2 w	5%
R871	311-159	20 k	Var. CAL. AMPL.
R872	301-154	150 k 1/2 w	5%
R873	302-103	10 k 1/2 w	
R876	301-153	15 k 1/2 w	5%
R877	301-183	18 k 1/2 w	5%
R878	301-564	560 k 1/2 w	5%
R879	Use 301-114	110 k 1/2 w	5%
R883	305-223	22 k 2 w	5%
R885	309-121	9.5 k 1/2 w	Prec. 1%
R886	309-119	6.375 k 1/2 w	Prec. 1%
R887	309-117	2.1 k 1/2 w	Prec. 1%
R888	309-116	1.025 k 1/2 w	Prec. 1%
R889	309-113	610 Ω 1/2 w	Prec. 1%
R890	309-073	200 Ω 1/2 w	Prec. 1%
R891	309-112	100 Ω 1/2 w	Prec. 1%

† S/N 582-up *050-115 may be used

†† S/N 582-up *050-118 may be used

Parts List—Type 564

Resistors (Cont'd)

Ckt. No.	Tektronix Part No.		Description			S/N Range
R892	309-067	60 Ω	1/2 w	Prec.		1%
R893	309-066	40 Ω	1/2 w	Prec.		1%
R896	309-045	100 k	1/2 w	Prec.		1%
R897	309-112	100 Ω	1/2 w	Prec.		1%
R898	309-112	100 Ω	1/2 w	Prec.		1%
R899	*308-090	.25 Ω	1 w	WW		
R903	302-333	33 k	1/2 v			
R904	311-026	100 k		Var.		STORAGE LEVEL
R906	311-374	250 k		Var.		NON-STORAGE LEVEL
R908	302-224	220 k	1/2 w			
R909	302-684	680 k	1/2 w			
R911	302-224	220 k	1/2 w			
R912	302-684	680 k	1/2 w			
R913	316-472	4.7 k	1/4 w			
R914	316-472	4.7 k	1/4 w			
R915	316-472	4.7 k	1/4 w			
R916	316-103	10 k	1/4 w			
R917	316-472	4.7 k	1/4 w			
R918	316-103	10 k	1/4 w			
R920	302-104	100 k	1/2 w			
R924	302-224	220 k	1/2 w			
R926	302-104	100 k	1/2 w			
R928	302-224	220 k	1/2 w			
R930	Use 311-374	250 k	3/4 w	Var.		COVERAGE 1
R931	Use 302-683	68 k	1/2 w			
R932	302-333	33 k	1/2 w			
R933	316-472	4.7 k	1/4 w			
R934	316-472	4.7 k	1/4 w			
R935	302-154	150 k	1/2 w			
R936	316-472	4.7 k	1/4 w			
R937	302-103	10 k	1/2 w			
R938	311-023	50 k		Var.		COVERAGE 2
R940	311-018	20 k		Var.		GEOMETRY
R941	302-822	8.2 k	1/2 w			
R944	311-068	500 k	.2 w	Var.		FLOOD-GUN BIAS B
R945	316-105	1 meg	1/4 w			X2000-up
R946	311-068	500 k	.2 w	Var.		FLOOD-GUN BIAS A
R947	316-105	1 meg	1/4 w			X2000-up
R948	315-103	10 k	1/4 w			5%
R949	316-183	18 k	1/4 w			X2000-up
R970	316-103	10 k	1/4 w			X2000-up
R971	316-474	470 k	1/4 w			X2000-up
R972	316-474	470 k	1/4 w			X2000-up
R974	316-104	100 k	1/4 w			X2000-up
R976	316-474	470 k	1/4 w			X3580-up

Ckt. No.	Tektronix Part No.	Description	S/N Range
Resistors (Cont'd)			
R977†	311-432	2 meg	
R978	316-104	100 k	1/4 w
R978	316-683	68 k	1/4 w
R979	316-104	100 k	1/4 w
R979	316-334	330 k	1/4 w
R983	302-123	12 k	1/2 w
R984	311-405	10 k	Var.
R985	302-182	1.8 k	1/2 w
			WW PULSE AMPL
			WRITING SPEED INCREASE
			X2000-up
			X2000-3579
			X3580-up
			X2000-3579
			3580-up
			X2000-up
			X2000-up
			X2000-up

SWITCHES

	Unwired	Wired		
SW601††	311-340		Slide	PWR. OFF
SW854	260-449		Push-Button	CRT CATHODE SELECTOR
SW868	Use *050-201		Push-Button	REPLACEMENT KIT
SW868	260-645		Push-Button	LOCATE (Trace)
SW870	260-253 *262-497		Rotary	CALIBRATOR
SW910	260-510}	*262-684	Lever	UPPER (Display)
SW911	260-510}		Lever	LOWER (Display)
SW948	Use *050-201		Push-Button	REPLACEMENT KIT
SW948	260-645		Push-Button	INTEGRATE
SW977†††	311-432			
				101-3470
				3471-up
				X2000-up
				X2000-up
				X2000-up

THERMAL CUTOUT

TK601	260-157	Thermal Cutout	160°F ±5°
-------	---------	----------------	-----------

TRANSFORMERS

T601	*120-296	Low Voltage
T801	*120-275	High Voltage

TRANSISTORS

Q624	*151-087	Selected from 2N1131	
Q734	151-040	2N1302	
Q744	151-042	2N1378	
Q757	151-060	2N1545	
Q975	*151-096	Selected from 2N1893	X2000-up
Q985	*151-096	Selected from 2N1893	X2000-up

†Furnished as a unit with SW977.

††Ganged with R601. Furnished as a unit.

†††Furnished as a unit with R977.

Parts List—Type 564

ELECTRON TUBES

Ckt. No.	Tektronix Part No.	Description	S/N Range
V609	154-291	OG3	
V627	154-307	7233	
V634	154-187	6DJ8	
V654	154-022	6AU6	
V667	154-020	6AS7	
V674	154-022	6AU6	
V800	154-167	6CZ5	
V814	154-046	12BH7A	
V822	154-051	5642	
V832	154-051	5642	
V859	*154-410	T5640-200 CRT	
V884	154-278	6BL8	
V913	154-041	12AU7	

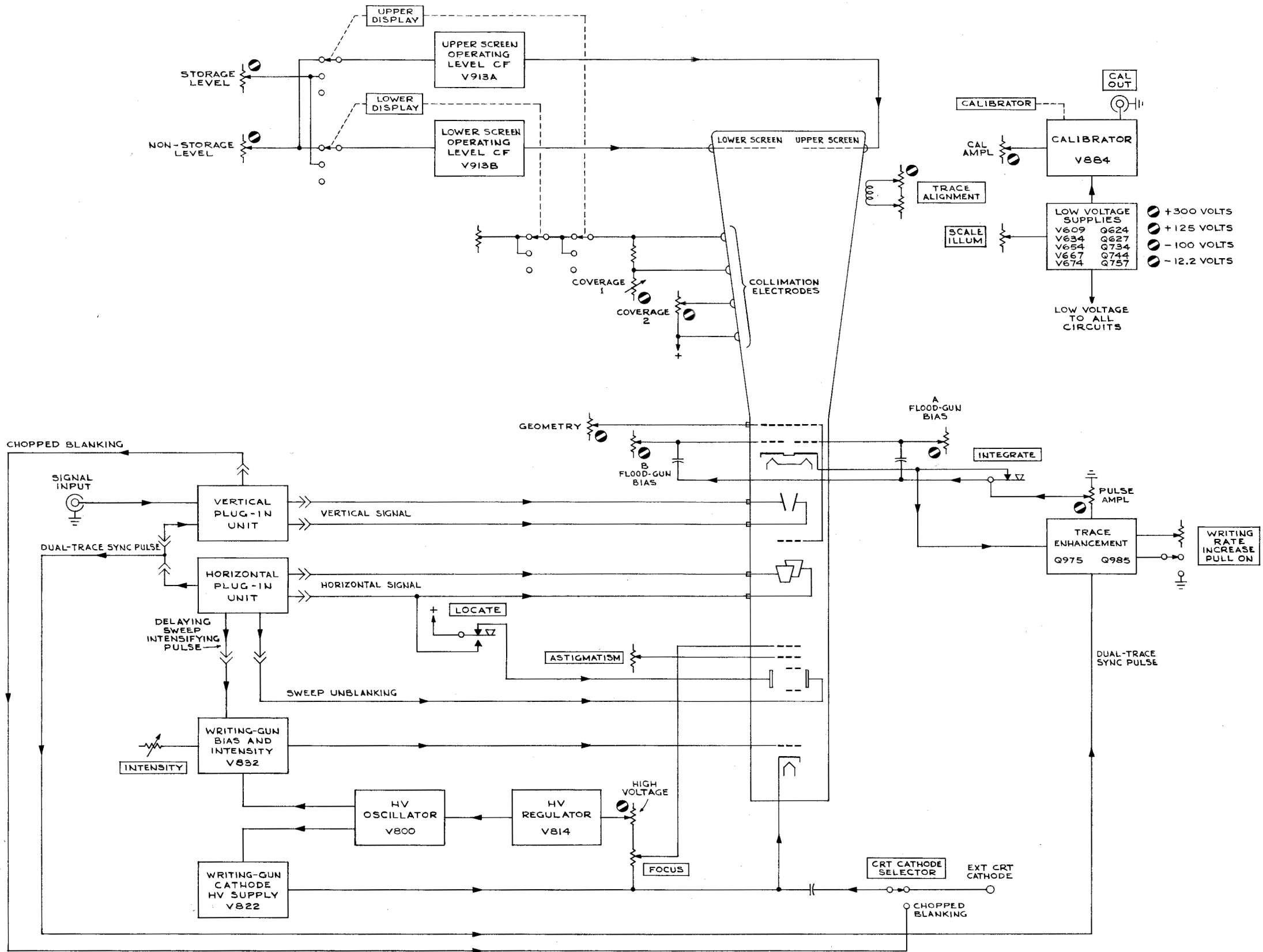

TEST CONDITIONS

All VOLTAGE READINGS were obtained under the following conditions unless otherwise noted on the specific diagrams:

Plug-In Units	Installed
Line Voltage	117 volts
Vertical Input Signal	None
Dc Voltmeter Impedance	20,000 Ω /volt
Control Settings:	
INTENSITY	Counterclockwise
FOCUS	Centered
CALIBRATOR	OFF
Upper DISPLAY	NON STORE
Lower DISPLAY	NON STORE
WRITING RATE INCREASE	Off (pushed in) and counter-clockwise
SCALE ILLUM	On
Sweep Mode	Single Sweep

Circuit VOLTAGE READINGS shown in blue are in volts dc, except where otherwise specified.

VOLTAGE READINGS may vary somewhat between instruments due to normal manufacturing tolerances and component characteristics.

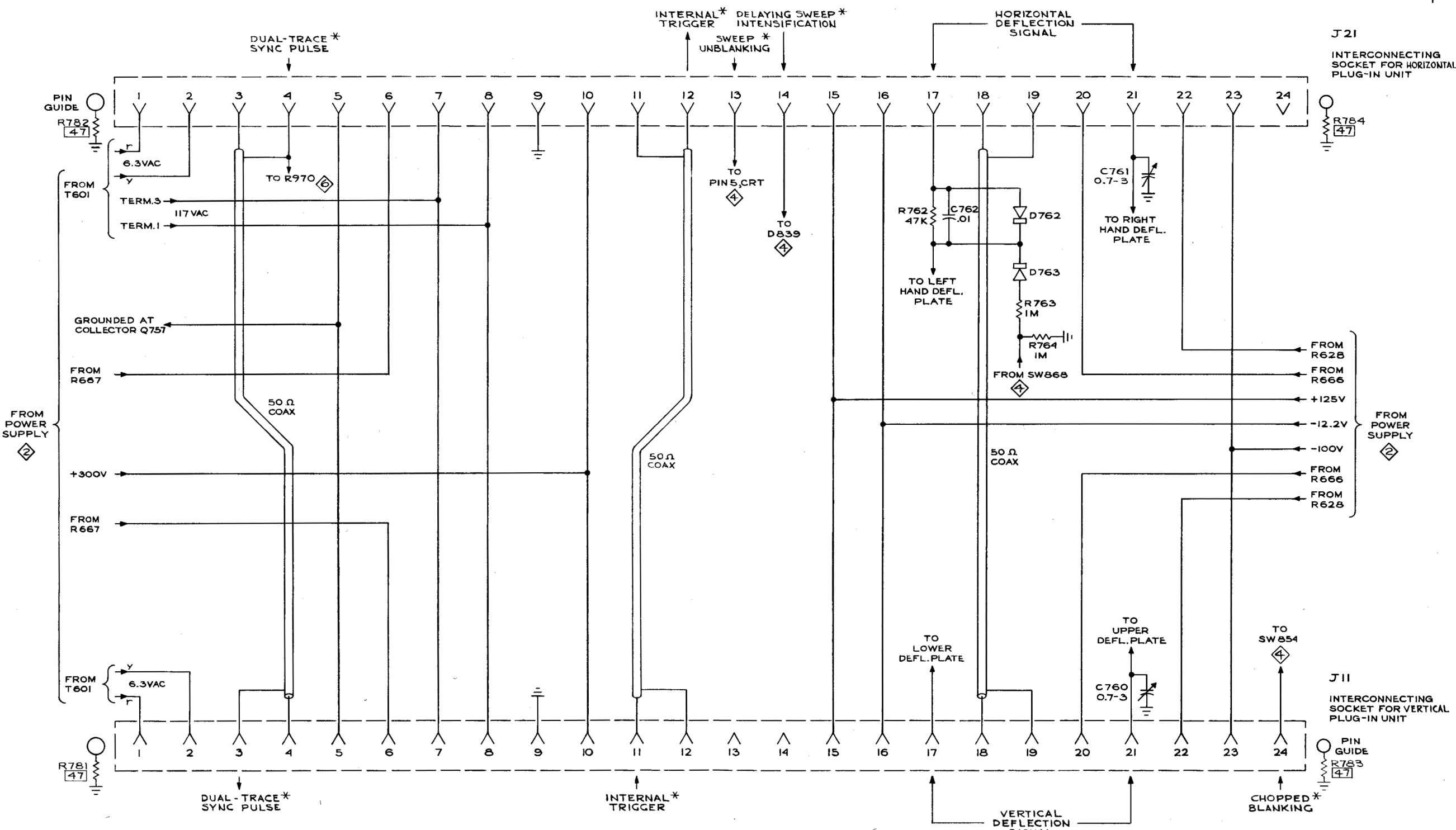

* INPUT AND OUTPUT SIGNALS WITH AMPLIFIER UNIT IN VERTICAL COMPARTMENT AND TIME-BASE UNIT IN HORIZONTAL COMPARTMENT.

- REFERENCE DRAWINGS:
- ② POWER SUPPLY
 - ④ CRT CIRCUIT
 - ⑥ STORAGE CIRCUIT

SEE PARTS LIST FOR EARLIER VALUES AND SERIAL NUMBER RANGES OF PARTS MARKED WITH BLUE OUTLINE.

CMD 964

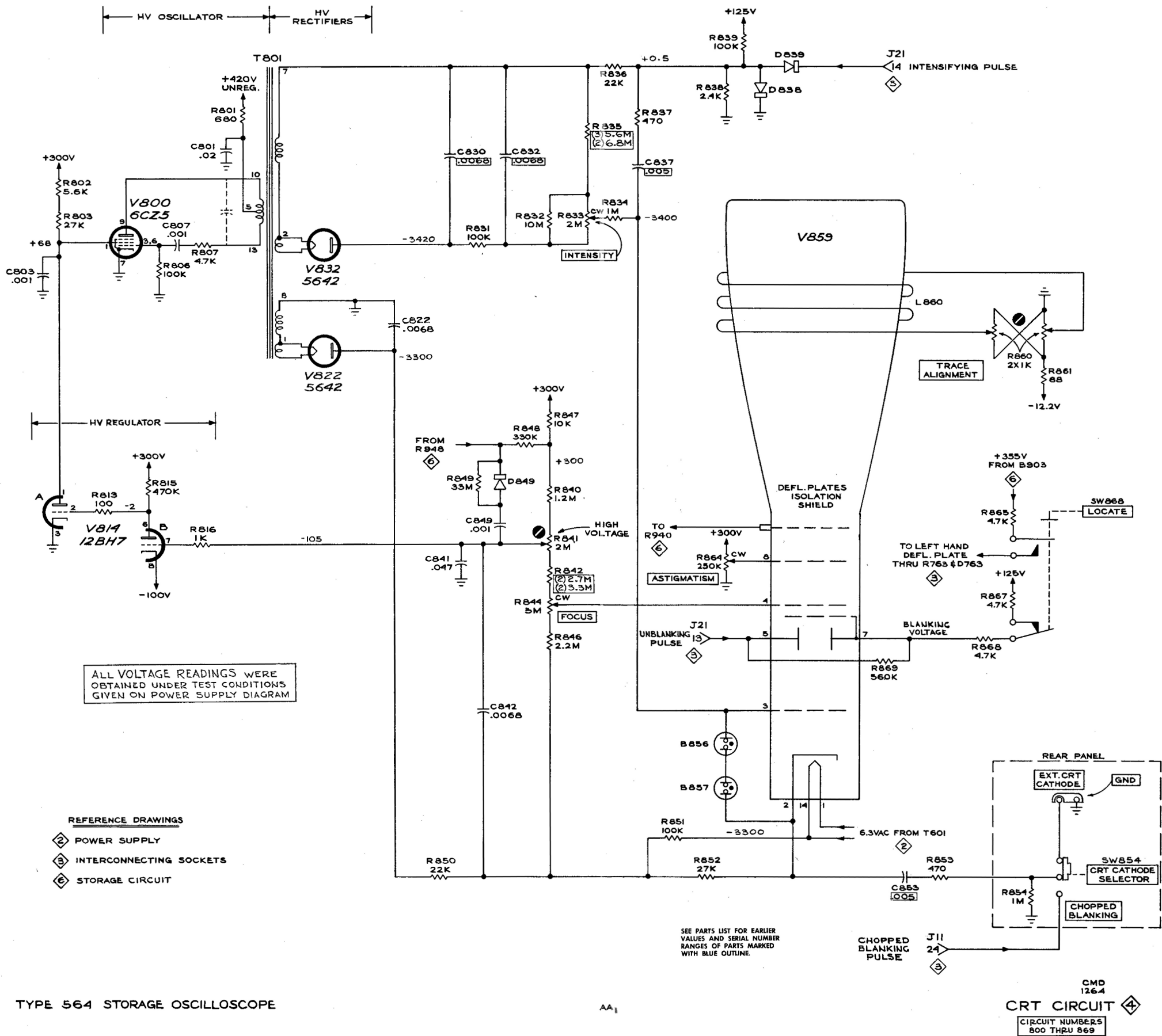

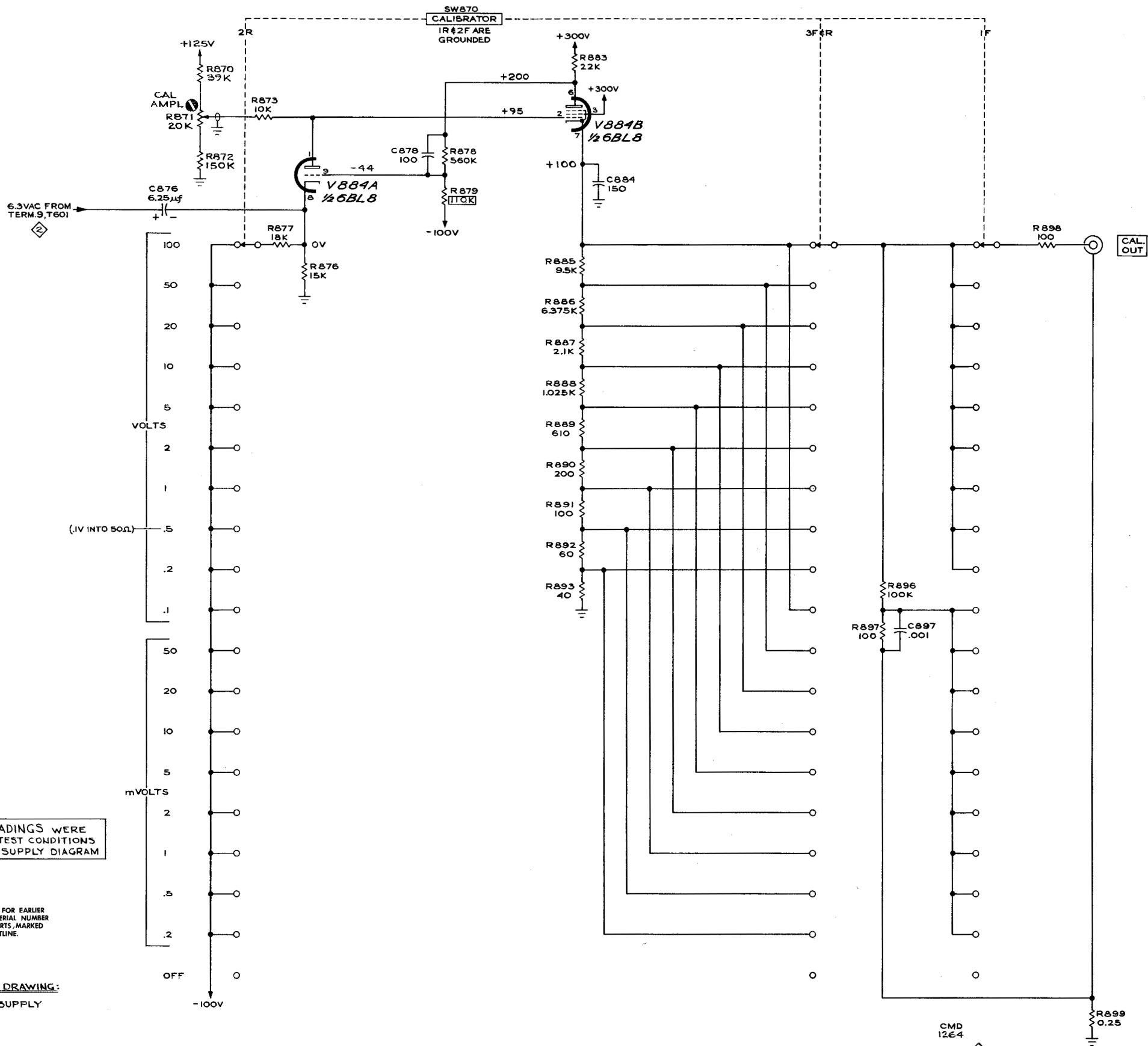

ALL VOLTAGE READINGS WERE OBTAINED UNDER TEST CONDITIONS GIVEN ON POWER SUPPLY DIAGRAM

SEE PARTS LIST FOR EARLIER VALUES AND SERIAL NUMBER RANGES OF PARTS MARKED WITH BLUE OUTLINE.

REFERENCE DRAWING:

POWER SUPPLY

TYPE 564 STORAGE OSCILLOSCOPE

AA₁

CMD 1264
CALIBRATOR
CIRCUIT NUMBERS 870 THRU 899

← OPERATING LEVEL CF'S →

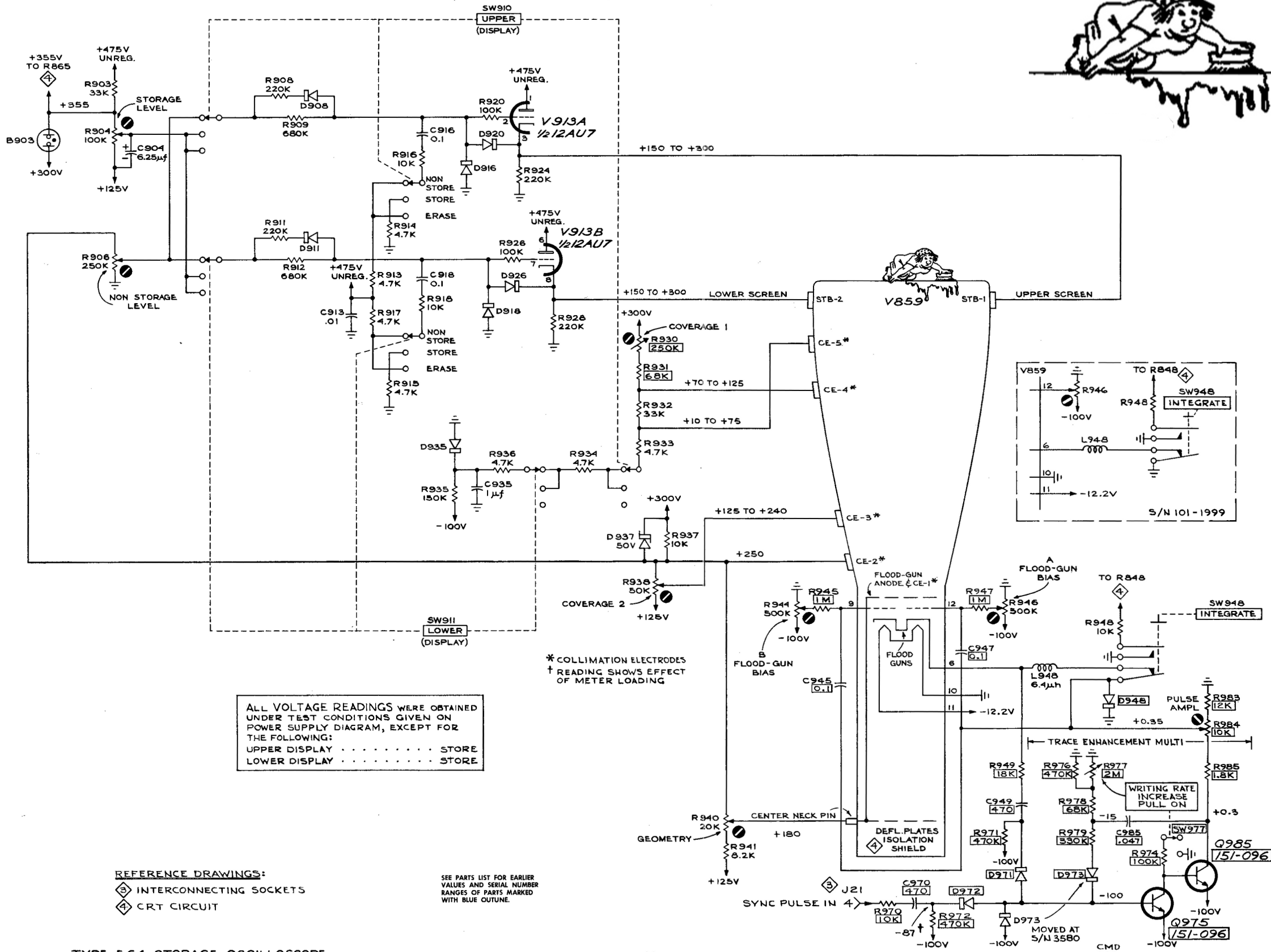

ALL VOLTAGE READINGS WERE OBTAINED UNDER TEST CONDITIONS GIVEN ON POWER SUPPLY DIAGRAM, EXCEPT FOR THE FOLLOWING:
 UPPER DISPLAY STORE
 LOWER DISPLAY STORE

* COLLIMATION ELECTRODES
 † READING SHOWS EFFECT OF METER LOADING

REFERENCE DRAWINGS:
 Ⓧ INTERCONNECTING SOCKETS
 Ⓞ CRT CIRCUIT

SEE PARTS LIST FOR EARLIER VALUES AND SERIAL NUMBER RANGES OF PARTS MARKED WITH BLUE OUTLINE.

TYPE 564 STORAGE OSCILLOSCOPE

AA1

STORAGE CIRCUIT Ⓧ

CIRCUIT NUMBERS 900 THRU 985

MANUAL CHANGE INFORMATION

At Tektronix, we continually strive to keep up with latest electronic developments by adding circuit and component improvements to our instruments as soon as they are developed and tested.

Sometimes, due to printing and shipping requirements, we can't get these changes immediately into printed manuals. Hence, your manual may contain new change information on following pages. If it does not, your manual is correct as printed.