



P5102
100 MHz High-Voltage Probe
Instructions

070-9294-01

Copyright © Tektronix, Inc. 1995. All rights reserved.

Tektronix products are covered by U.S. and foreign patents, issued and pending. Information in this publication supercedes that in all previously published material. Specifications and price change privileges reserved.

Printed in the U.S.A.

Tektronix, Inc., P.O. Box 1000, Wilsonville, OR 97070-1000

TEKTRONIX, TEK, TekTools, and TekScope are registered trademarks of Tektronix, Inc.



Table of Contents

General Safety Summary	iii
Features and Accessories	1
Operating Basics	5
Maximum Non-destructive Input Voltage	5
Common Lead Length	5
Probe Loading	6
Adjustment Procedures	7
LF Compensation	7
HF Compensation	8
Performance Verification	13
Maintenance	15
Cleaning Instructions	15
Customer Support	15
Preparation for Shipment	16
Specifications	17
Replaceable Parts	22

List of Figures

Figure 1: Waveform Distortion from Common Lead Length . .	5
Figure 2: Probe Loading Equivalent Circuit	6
Figure 3: LF Compensation Setup	7
Figure 4: LF Compensation Adjustment	8
Figure 5: Signal Source Characteristics for HF Compensation .	8
Figure 6: Opening the Compensation Box	9
Figure 7: HF Compensation Setup	10
Figure 8: HF Compensation Adjustments	11
Figure 9: HF Compensation Regions of Fast Rise Signal	12
Figure 10: Bandwidth Test Setup	14
Figure 11: Maximum Voltage Derating Curves (V_{RMS} , DC Coupled)	18
Figure 12: Typical Input Impedance	19
Figure 13: Typical Input Phase	20
Figure 14: P5102 Replaceable Parts	22

List of Tables

Table 1: Required Test Equipment	13
Table 2: Warranted Electrical Specifications	17
Table 3: Typical Electrical Characteristics	19
Table 4: Typical Mechanical Characteristics	21
Table 5: Environmental Specifications	21



General Safety Summary

Review the following safety precautions to avoid injury and prevent damage to this product or any products connected to it.

Only qualified personnel should perform service procedures.

Injury Precautions

Avoid Electric Overload. To avoid injury or fire hazard, do not apply potential to any input, including the common inputs, that varies from ground by more than the maximum rating for that input.

Avoid RF Burns While Handling Probe. To avoid RF burns, do not handle the probe while the common lead is connected to circuits above the voltage and frequency limits specified in Figure 11b on page 18.

Avoid Electric Shock. To avoid injury or loss of life, do not connect or disconnect probes or test leads while they are connected to a voltage source.

Do Not Operate Without Covers. To avoid electric shock or fire hazard, do not operate this product with covers or panels removed.

Do Not Operate in an Explosive Atmosphere. To avoid injury or fire hazard, do not operate this product in an explosive atmosphere.

Keep Probe Surface Clean and Dry. To avoid electric shock and erroneous readings, keep probe surface clean and dry.

Product Damage Precautions

Do Not Operate With Suspected Failures. If you suspect there is damage to this product, have it inspected by qualified service personnel.

Do Not Immerse in Liquids. Clean the probe using only a damp cloth. Refer to cleaning instructions on page 15.

Safety Terms and Symbols

Terms in This Manual. These terms may appear in this manual:

General Safety Summary



WARNING. Warning statements identify conditions or practices that could result in injury or loss of life.



CAUTION. Caution statements identify conditions or practices that could result in damage to this product or other property.

Terms on the Product. These terms may appear on the product:

DANGER indicates an injury hazard immediately accessible as you read the marking.

WARNING indicates an injury hazard not immediately accessible as you read the marking.

CAUTION indicates a hazard to property including the product.

Symbols on the Product. These symbols may appear on the product:



DANGER
High Voltage



Protective Ground
(Earth) Terminal



ATTENTION
Refer to Manual



Double
Insulated

Certifications and Compliances

Compliances. Consult the product specifications for Overvoltage Category and Safety Class.

Overvoltage Category. Overvoltage categories are defined as follows:

CAT III: Distribution level mains, fixed installation

CAT II: Local level mains, appliances, portable equipment

CAT I: Signal level, special equipment or parts of equipment, telecommunication, electronics

Features and Accessories

The P5102 is a high-voltage passive probe designed for use with TekScope THS 700 series instruments. The probe features a floating common and is ideal for measuring and troubleshooting power supplies and high-voltage devices. The probe provides 10X attenuation of signals up to 1000 V_{RMS} and derated performance up to 100 MHz. The P5102 probe is certified to international safety standards.

The P5102 probe has features and accessories to make high-voltage measurements safer and easier. Please take a moment to familiarize yourself with these features and accessories and their uses.



WARNING. Do not substitute accessories from other products for those provided with the P5102. The accessories for the P5102 have been safety tested. The use of non-tested accessories may cause injury.

P5102 Features and Standard Accessories

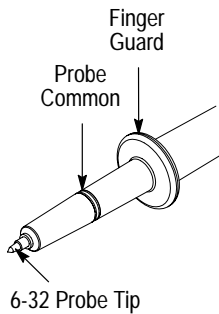

Probe Body – The P5102 probe body is designed for personal safety, ergonomic comfort, and signal fidelity.

The finger guard provides protection when the hook tips are not being used. Keep your fingers behind the finger guard whenever possible to reduce the risk of a shock from the circuit under test.

The probe tip is a 6–32 threaded post that accepts both standard and optional accessories.

Keep the probe body and accessories clean to reduce the risk of shock due to surface conduction.

P5102 Features and Standard Accessories (Cont.)

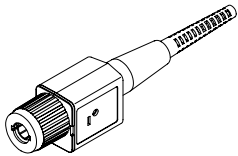

Compensation Box – The compensation box contains low- and high-frequency compensation adjustments. The high-frequency adjustments are accessible by removing the compensation box cover. Refer to *Adjustments* on page 7.

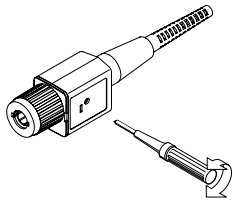

Adjustment Tool – Use the supplied adjustment tool for probe compensation adjustments. Do not use metallic or conductive tools while making adjustments.

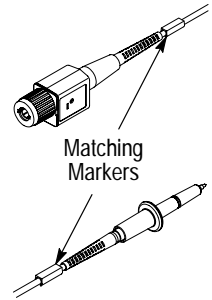

Color Markers – The matching markers help you identify probe inputs at a glance. Clip one marker near the probe head and the matching marker near the compensation box as shown.

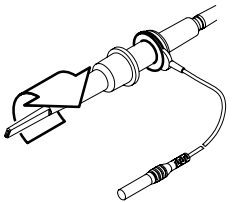

Small Hook Tip – Use the small hook tip for making connections to small conductors such as component leads.

Install the small hook tip by sliding it over the body of the probe and screwing it onto the threaded probe tip.

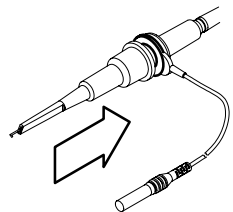

To use the tip, hold the probe body and pull the tip shield back. Hook the tip onto the circuit and release the shield. The hook tip will firmly hold the conductor under test.

P5102 Features and Standard Accessories (Cont.)

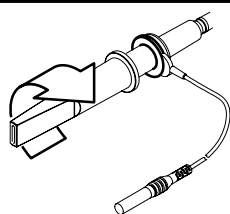

Large Hook Tip – Use the large hook tip when working with larger components such as bolt terminals and buss bars typically found in power distribution equipment.

Install the large hook tip by sliding it over the body of the probe and screwing it onto the threaded probe tip.

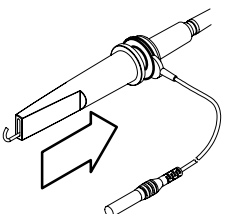

To use the tip, hold the probe body and pull the tip shield back. Hook the tip onto the circuit and release the shield. The hook tip will firmly hold the conductor under test.

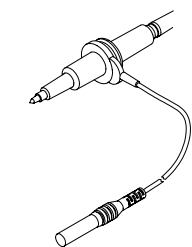

Common Leads – The P5102 probe comes with a long and a short floating common lead. Both common leads connect to a removable crocodile clip.

Attach the common lead to the probe body by inserting the probe head into common lead as shown.

The length of the common lead directly impacts the fidelity of high-frequency signals. The longer the common lead, the more the signal will be distorted. For more information about the common lead and signal quality, go to page 5.

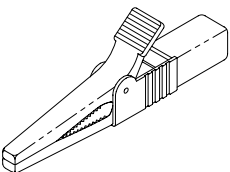

Crocodile Clip – The large crocodile clip attaches to the insulated banana connector on the common leads.



WARNING. For safe electrical connections, use the crocodile clip provided. Do not attempt to substitute the crocodile clip with any other accessory.

Features and Accessories

P5102 Optional Accessories

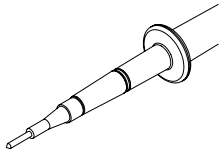

Probe Tip Extender (P6000) – Use the probe tip extender to connect the probe to larger test sockets located in equipment or on printed circuit boards.

Connect the probe tip extender by screwing it onto the threaded probe tip.

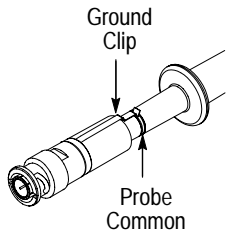

Probe-to-BNC Adapter – Use the probe-to-BNC adapter to connect the probe directly to BNC connectors. The adapter is recommended for use when verifying or adjusting the probe.

Attach the adapter by pressing it onto the 6-32 probe tip and making sure that the ground clip makes contact with the probe common.



WARNING. Do not connect the adapter to a floating or high-voltage source. The BNC adapter is only rated to 500 V (DC + peak AC) with the probe common connected to earth ground.

Operating Basics

To get guaranteed performance from the P5102 probe, please read and apply the information in this section.

Observe Voltage Derating Information



WARNING. To avoid personal injury, do not handle the probe when the common lead is connected to a source that is above the voltage and frequency limits given in Figure 11b on page 18.

To avoid personal injury or damage to the probe, do not connect the probe input to a source that is above the maximum non-destructive input voltage and frequency limits given in Figure 11a on page 18.

Common Lead Length

Always use as short a common lead as possible between the probe head and circuit common for high frequency or fast rise time signals.

The input capacitance of the probe and the series inductance added by the probe tip and common lead can result in a resonant circuit; this circuit may cause parasitic “ringing” visible within the bandwidth of your oscilloscope. Refer to Figure 1.

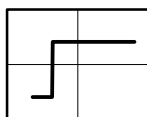

6-inch Common

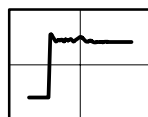

18-inch
Common

Figure 1: Waveform Distortion from Common Lead Length

Parasitic ringing is not a concern when the probe is used with low frequency or slow rise time signals and is not apparent if the frequency content is beyond the bandwidth of the oscilloscope.

Probe Loading

When you touch your probe tip to a circuit element, you are introducing a new resistance, capacitance, and inductance into the circuit. Refer to Figure 2.

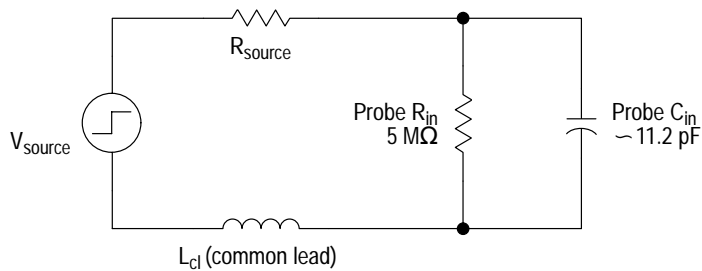

Figure 2: Probe Loading Equivalent Circuit

Frequency and impedance of the source determine how much the probe loads the circuit you are measuring. As the frequency of the source starts to increase beyond 1 kHz, the input impedance of the probe begins to decrease. The lower the impedance of the probe relative to that of the source, the more the probe loads the circuit under test. Refer to Figure 12 on page 19 for a graph of frequency versus input impedance.

The probe has virtually no loading effect on sources with relatively low impedance and low frequency.

Adjustment Procedures

The low-frequency (LF) compensation of the P5102 probe must be checked every time the probe is connected to a different oscilloscope input.

The high-frequency (HF) compensation should be checked if the probe was repaired or fails to meet rated bandwidth specifications. Check the probe using the performance verification procedures on page 13 to determine if adjustment is required.

LF Compensation

Before taking any measurements with the probe, first check the LF compensation of the probe and adjust it to match the channel input it is connected to.

1. Connect the probe to the Probe Comp signal on your TekScope instrument and then press **AUTORANGE**. See Figure 3.

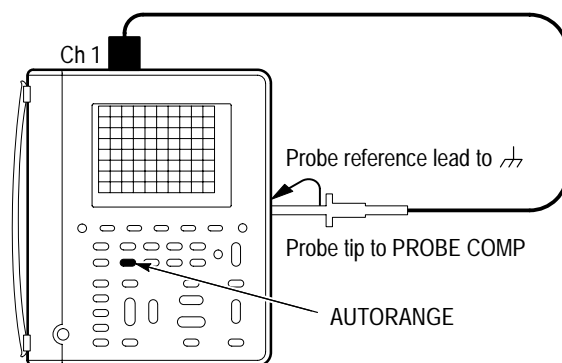

Figure 3: LF Compensation Setup

2. Compensate the probe by adjusting the trimmer in the probe compensation box so that the corners of the signal are square. See Figure 4.

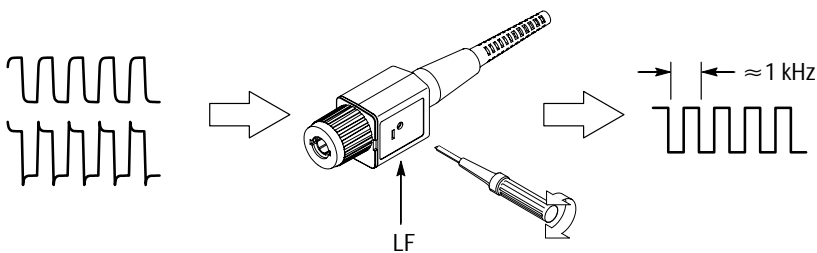

Figure 4: LF Compensation Adjustment

HF Compensation

To compensate the probe for high frequencies, you will need a properly terminated signal source that has the characteristics given in Figure 5. Refer to Table 1 on page 13 for a complete list of required test equipment.

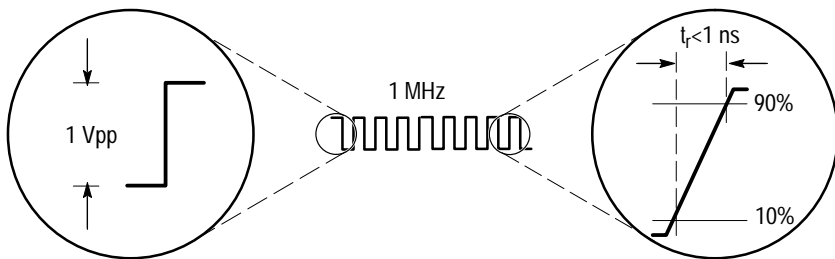

Figure 5: Signal Source Characteristics for HF Compensation

To access the HF adjustments of the probe, you must open the cover of the compensation box using the procedure that follows.

Opening the Compensation Box

NOTE. This procedure should be performed by qualified service personnel only.

To open the cover, obtain two small screwdrivers and use them to unlatch the tab as shown in Figure 6.



WARNING. Avoid damaging the tab. A damaged tab will allow the cover to easily separate and expose the user to the electrical potential of the common connection.

To avoid damaging the tab, do not attempt to press on the tab through the hole in the cover where it latches. In the event of a damaged tab, replace the probe.

1. Insert the flat blade of small screwdriver (A) into the location shown in Figure 6. Insert the blade until it stops against the back of the tab.

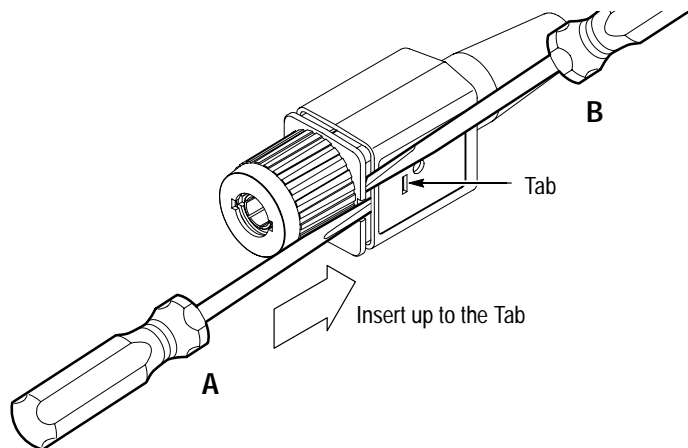

Figure 6: Opening the Compensation Box

2. While holding screwdriver (A) in place, insert small screwdriver (B) between the ridge on the front of the compensation box and the edge of the cover.
3. Gently twist the blade of screwdriver (B) to separate the cover and unlatch the tab.
4. After unlatching the tab, slide the cover back to expose the internal adjustments.

HF Compensation Procedure

After opening the compensation box, perform the following procedure to compensate the probe for high frequencies.

1. Connect a 50 Ω feedthrough termination to the positive going **FAST RISE** output of the calibration generator. See Figure 7.

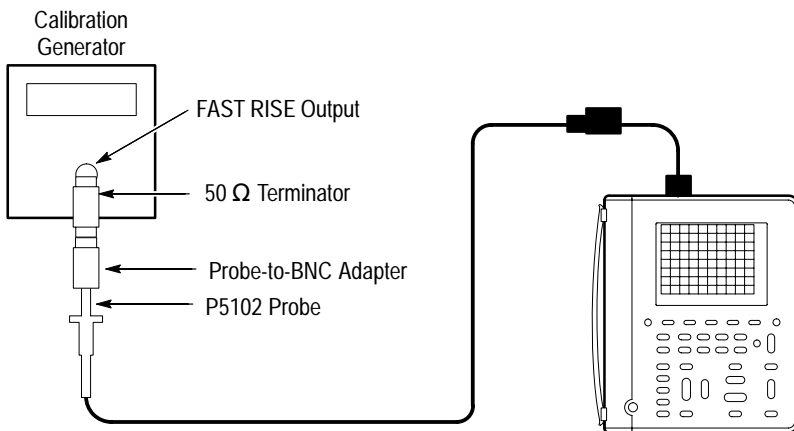

Figure 7: HF Compensation Setup

2. Refer to page 4 and use the optional probe-to-BNC adapter to connect the probe to the termination.
3. Set the Calibration Generator to 1 MHz.
4. Set the **PULSE AMPLITUDE** to 0.5 V_{P-P}.

NOTE. If you have changed the default setting for the probe type, access the vertical menu of the TekScope instrument and return the setting to 10X.

5. Set the oscilloscope to 100 mV/division.
6. Set the oscilloscope averaging to 4.
7. Set the oscilloscope to 10 ns/div (100 ns, X10 magnification)
Adjust the oscilloscope as necessary to view the leading edge of the waveform.
8. Locate the **HF1** and **HF2** adjustments. See Figure 8.

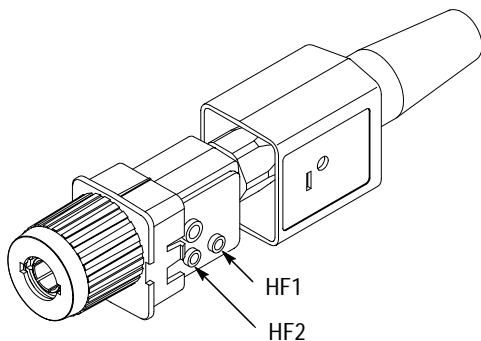

Figure 8: HF Compensation Adjustments

9. Preset **HF1** counterclockwise and **HF2** clockwise.
10. Adjust **HF2** for flatness and adjust **HF1** for the best front corner. See Figure 9. Because **HF1** and **HF2** interact, readjust **HF2** and **HF1** as necessary to achieve the best rise time with the smallest aberrations.

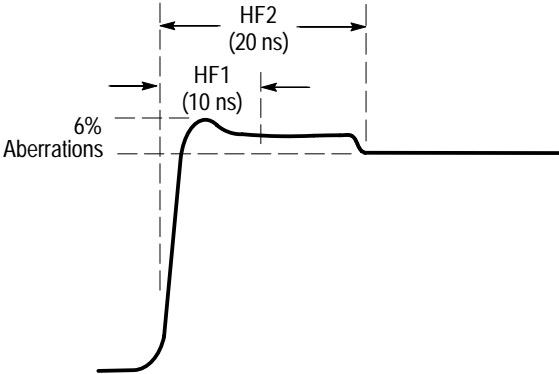

Figure 9: HF Compensation Regions of Fast Rise Signal

- 11. After compensating the HF, carefully slide the cover back until the tab latches securely into place.

Performance Verification

Use the procedure in this section to verify that the P5102 probe meets the warranted bandwidth specification highlighted with boldface type in the *Specifications* section on page 17. The steps of this procedure must be performed in the order given using a THS 720 TekScope instrument and other equipment that meets the minimum requirements listed in Table 1.

Table 1: Required Test Equipment

Description	Minimum Requirements	Example
Oscilloscope	Use a THS 720 only. The probe is optimized to match the input characteristics and bandwidth of the THS 720	THS 720
Calibration Generator (for HF adjustment only)	≤ 1 ns rise time square wave	Wavetek 9100 Universal Calibration System with Oscilloscope Calibration Module (Option 250)
Leveled Signal Generator	50 kHz to 250 MHz	
Termination, 50 Ω feedthrough	50 Ω male to female BNC	Tektronix 011-0049-01
Adapter, probe tip to BNC	Probe tip to male BNC	Tektronix 013-0291-00

NOTE. *Compensate the probe for LF before performing this procedure. The LF compensation procedure begins on page 7.*

If the probe does not meet the bandwidth requirement of this procedure, perform the adjustments beginning on page 7 and retest.

1. Connect the test setup as shown in Figure 10.

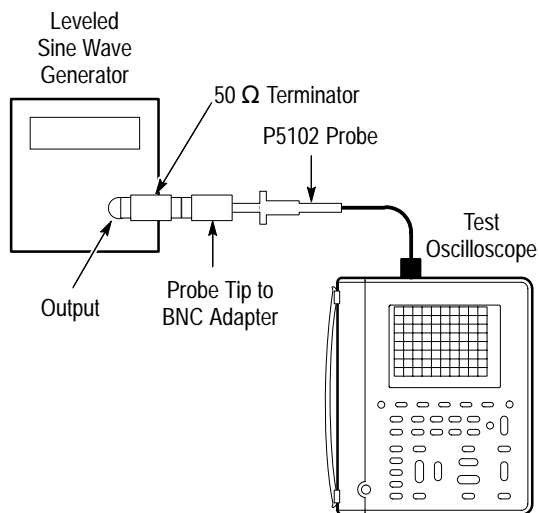

Figure 10: Bandwidth Test Setup

2. Set the leveled signal generator output frequency to 1 MHz.

NOTE. If you have changed the default setting for the probe type, access the vertical menu of the TekScope instrument and return the setting to 10X.

3. Set the oscilloscope to 50 mV/division. (The effective setting with the 10X attenuation of the probe is 500 mV/division.)
4. Adjust the Leveled Signal Generator for a display exactly 6 divisions peak-to-peak.
5. Increase the Leveled Signal Generator frequency until the display is 4.2 divisions peak-to-peak. (This represents the .707 or half-power amplitude.)
6. Note that the frequency is greater than 100 MHz.

Maintenance

This section contains information necessary for the maintenance and repair of the P5102 probe.

***NOTE.** The P5102 probe has no replaceable components. Accessory parts may be ordered as indicated in the replaceable parts list.*

Cleaning Instructions

Clean the probe using a soft cloth dampened with a mild detergent and water solution. Do not use any other chemicals or abrasives.

Customer Support

Who To Call	When To Call	Where To Call
Operational Support	Call if you need help using your probe or to order accessories	1-800-TEK-WIDE (1-800-835-9433) If outside the United States or Canada, contact your nearest Tektronix Field Office
Service Support	Call if your probe needs repair	Call your nearest Tektronix Service Center

Preparation for Shipment

If you need to ship your probe, pack it carefully to prevent damage while in transit. If the original packaging is unfit for use or not available, use the following packaging guidelines:

1. Use a corrugated cardboard shipping carton having inside dimensions at least one inch greater than the probe dimensions. The box should have a carton test strength of at least 200 pounds.
2. Put the probe into a plastic bag or wrap to protect it from dampness in transit.
3. Place the probe into the box and stabilize it with light packing material.
4. Seal the carton with shipping tape.

Specifications

The warranted specifications of Table 2 that appear in boldface type are specifications checked in the *Performance Verification* section. Specifications that are not warranted are typical (Tables 3 and 4) and are provided as general information for your convenience.

The specifications apply to a P5102 probe installed on a Tektronix THS 720 oscilloscope. The instrument must have a warm-up period of at least 10 minutes and be in an environment that does not exceed the limits described in Table 5.

Table 2: Warranted Electrical Specifications

Attenuation (DC coupled system)	X10, $\pm 2\%$		
Bandwidth (-3 dB, DC coupled system)	DC to 100 MHz (THS 720) DC to 60 MHz (THS 710)		
Maximum Rated Input Voltage	<i>IEC 1010-1 Installation Category</i>		
	I	II	III
Between probe tip and probe common or between probe tip and earth ground (Refer to Figure 11a for derating with frequency)	1000	1000	600
Between probe common and earth ground (Refer to Figure 11b for safe-handling limits for overload and RF)	600	600	300
Safety	UL 3111-1 First Edition CSA 22.2 No. 1010.1-92, Series M89 EN 61010-1 EN 61010-2-031		
IEC Installation Category	Category II		
IEC Pollution Degree	Degree 2		
IEC Safety Class	Class 2 (Double/Reinforced Insulation)		

Specifications

a. Maximum non-destructive input voltage (probe tip to common or earth ground)

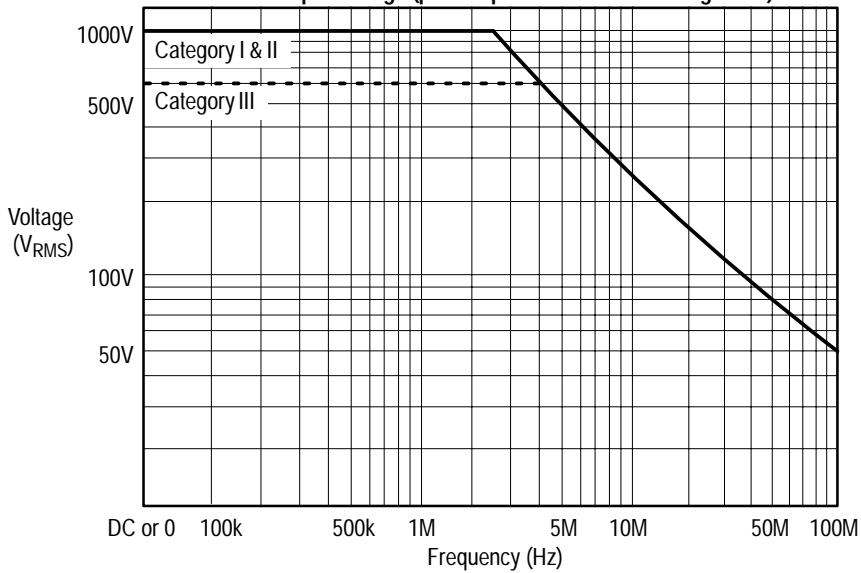

b. Maximum safe-handling limits (probe common to earth ground)

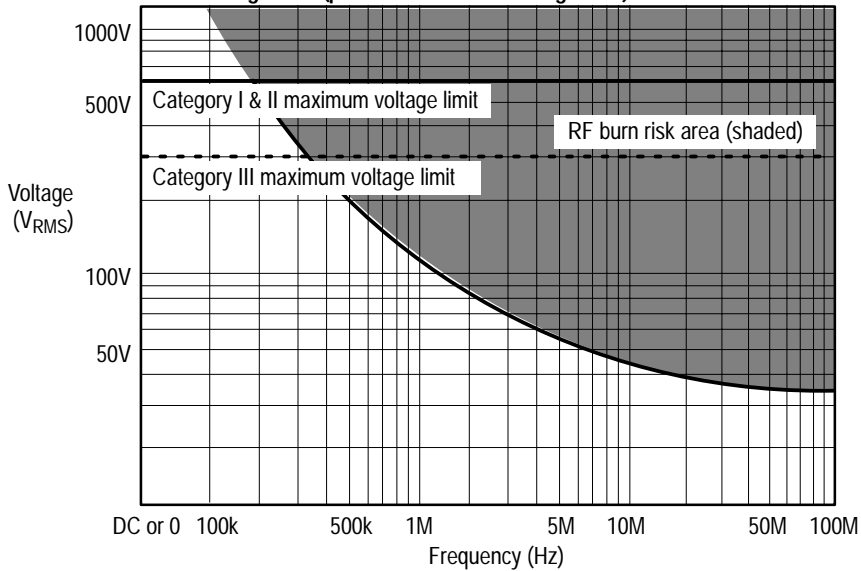

Figure 11: Maximum Voltage Derating Curves (V_{RMS}, DC Coupled)

Table 3: Typical Electrical Characteristics

Rise Time (System)	3.5 ns (THS 720)
Checked using optional BNC adapter	5.8 ns (THS 710)
Input Resistance (System) See Figure 12	5 M Ω
Input Phase (System)	(See Figure 13)
Compensation Range	23 pF to 27 pF
Input Capacitance (System) Probe connected to instrument and properly compensated. Checked at 1 MHz	11.2 pF

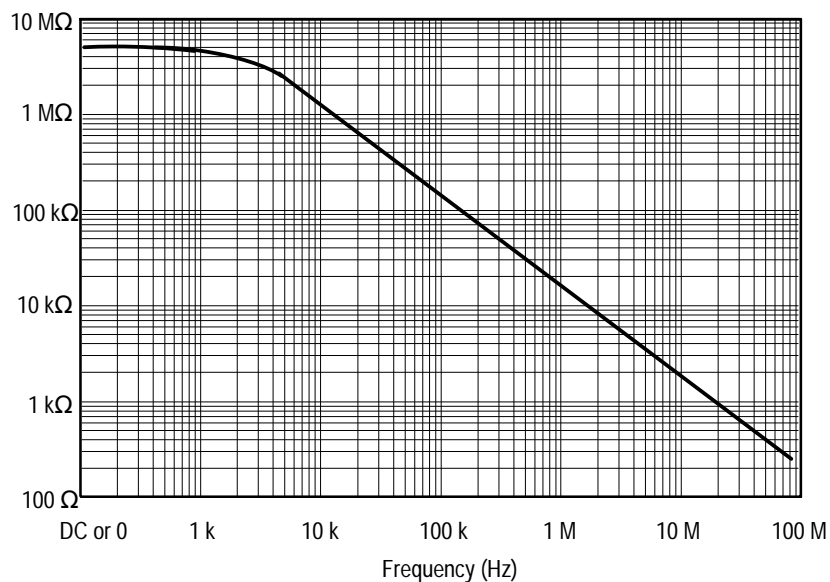

Figure 12: Typical Input Impedance

Specifications

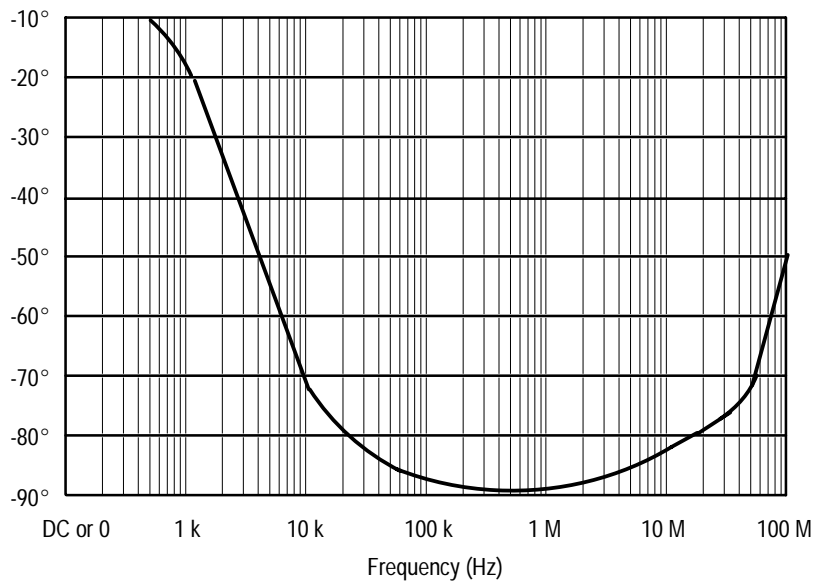

Figure 13: Typical Input Phase

Specifications

Table 4: Typical Mechanical Characteristics

Net Weight (including accessories)	0.26 kg (0.57 lb)
Cable Length	2 m (6.56 ft)

Table 5: Environmental Specifications

Temperature MILSTD T28800E, Class 3	Operating:	-15° C to +55° C (+5° F to +131° F)
	Nonoperating:	-62° C to +85° C (-79.6° F to +185° F)
This environmental exposure is more severe than that stated in MIL-T-28800E for Class 3 Equipment		
Humidity MIL Std T28800E, Class 3	Nonoperating and operating: Five cycles (120 hr. total) at 95% to 97% relative humidity	
This environmental exposure is more severe than that stated in MIL-T-28800E for Class 3 Equipment		
Transportation	Qualified under the National Safe Transit Association's Preshipment Test Procedures, Project 1A-B	

Replaceable Parts

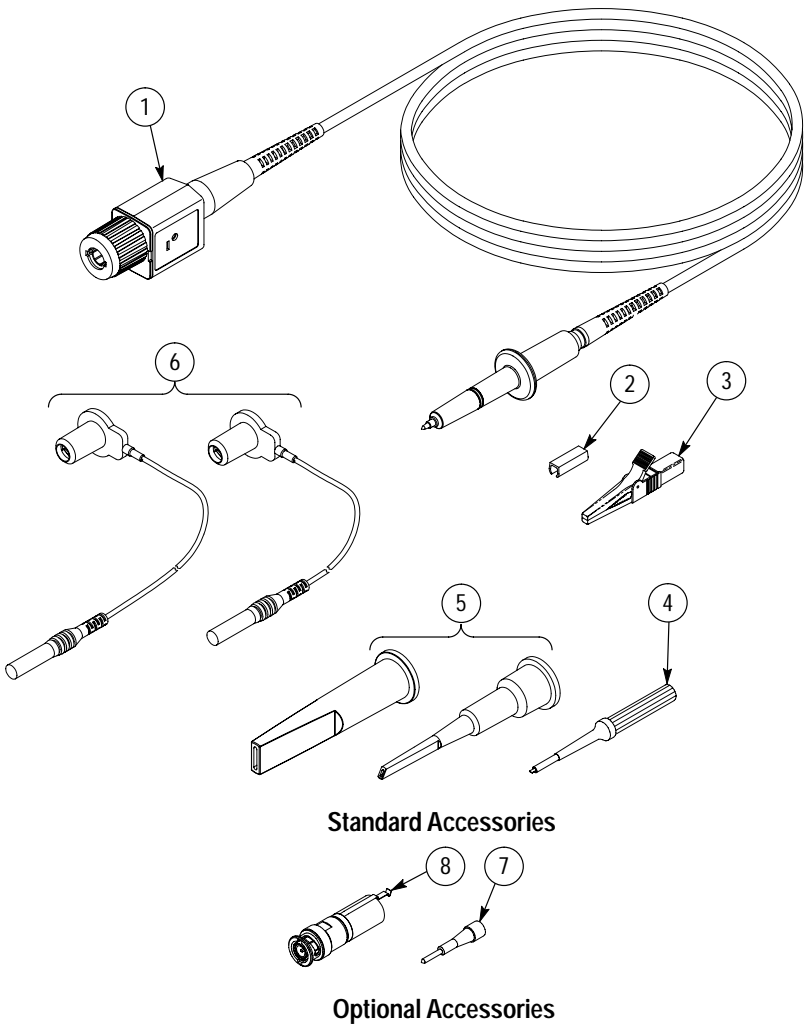

Figure 14: P5102 Replaceable Parts

Replaceable Parts

Fig. & Index No.	Tektronix Part No.	Serial No. Effective	Discont	Qty	12345 Name & Description	Mfr. Code	Mfr. Part No.
14-1				1	PROBE, HI VOLTAGE: FLOATING, 10X, 100 MHz, P5102		
					STANDARD ACCESSORIES		
-2	334-1275-02			2	CLIP, CABLE MKR: RED, PLASTIC	0JR05	Order by description
	334-1275-04			2	CLIP, CABLE MKR: YELLOW, PLASTIC	0JR05	Order by description
	334-1275-05			2	CLIP, CABLE MKR: GREEN, PLASTIC	0JR05	Order by description
-3	344-0461-00			1	CLIP, ELEC: CROCODILE: 82MM L, 4MM	TK2483	XK-081
-4	See Opt. Acc.			1	SCREWDRIVER: ADJUSTMENT TOOL		
-5	013-0290-01			1	HOOK TIP: SET: HOOK TIP ASSY: LARGE AND SMALL	TK2469	013029001
-6	196-3424-00			1	LEAD SET ASSY: COMMON, P5102, 1) 18.0 L 1) 6.0 L		
	070-9294-XX			1	MANUAL, TECH: INSTRUCTIONS, P5102	80009	0709294XX
					OPTIONAL ACCESSORIES		
-7	206-0060-00			1	TIP, PROBE: P6000	80009	206006000
-8	013-0291-00			1	ADAPTER, PROBE: PROBE TO BNC	80009	013029100
-4	003-1433-01			1	SCREWDRIVER: ADJUSTMENT TOOL, PKG OF 5	80009	003143301

Replaceable Parts

CROSS INDEX - MFR. CODE NUMBER TO MANUFACTURER

Mfr. Code	Manufacturer	Address	City, State, Zip Code
0JR05	TRIQUEST CORP		
TK2483	HEINRICH C KOSMEIER GMBH-ESSEN	MESSTECHNISCHE WERKE CATHOSTRASSA 7	D-4300 ESSEN 11 (W GERMANY)
TK2469	UNITREK CORPORATION	3000 LEWIS & CLARK HWY	VANCOUVER WA 98661
80009	TEKTRONIX INC	14150 SW KARL BRAUN DR PO BOX 500	BEAVERTON OR 97077-0001

WARRANTY

Tektronix warrants that this product will be free from defects in materials and workmanship for a period of one (1) year from the date of purchase from an authorized Tektronix distributor. If any such product proves defective during this warranty period, Tektronix, at its option, either will repair the defective product without charge for parts and labor, or will provide a replacement in exchange for the defective product. Batteries are excluded from this warranty.

In order to obtain service under this warranty, Customer must notify Tektronix of the defect before the expiration of the warranty period and make suitable arrangements for the performance of service. Customer shall be responsible for packaging and shipping the defective product to the service center designated by Tektronix, shipping charges prepaid, and with a copy of customer proof of purchase. Tektronix shall pay for the return of the product to Customer if the shipment is to a location within the country in which the Tektronix service center is located. Customer shall be responsible for paying all shipping charges, duties, taxes, and any other charges for products returned to any other locations.

This warranty shall not apply to any defect, failure or damage caused by improper use or improper or inadequate maintenance and care. Tektronix shall not be obligated to furnish service under this warranty a) to repair damage resulting from attempts by personnel other than Tektronix representatives to install, repair or service the product; b) to repair damage resulting from improper use or connection to incompatible equipment; or c) to repair damage resulting from improper use of connection to incompatible equipment; or d) to service a product that has been modified or integrated with other products when the effect of such modification or integration increases the time or difficulty of servicing the product.

THIS WARRANTY IS GIVEN BY TEKTRONIX WITH RESPECT TO THIS PRODUCT IN LIEU OF ANY OTHER WARRANTIES, EXPRESSED OR IMPLIED. TEKTRONIX AND ITS VENDORS DISCLAIM ANY IMPLIED WARRANTIES OF MERCHANTABILITY OR FITNESS FOR A PARTICULAR PURPOSE. TEKTRONIX' RESPONSIBILITY TO REPAIR OR REPLACE DEFECTIVE PRODUCTS IS THE SOLE AND EXCLUSIVE REMEDY PROVIDED TO THE CUSTOMER FOR BREACH OF THIS WARRANTY. TEKTRONIX AND ITS VENDORS WILL NOT BE LIABLE FOR ANY INDIRECT, SPECIAL, INCIDENTAL, OR CONSEQUENTIAL DAMAGES IRRESPECTIVE OF WHETHER TEKTRONIX OR THE VENDOR HAS ADVANCE NOTICE OF THE POSSIBILITY OF SUCH DAMAGES.