

# TEKTRONIX®

P6054A  
PROBE

010-6054-13

## INSTRUCTION MANUAL

Tektronix, Inc.  
P.O. Box 500  
Beaverton, Oregon 97005

Serial Number \_\_\_\_\_



## WARRANTY

All TEKTRONIX instruments are warranted against defective materials and workmanship for one year. Any questions with respect to the warranty should be taken up with your TEKTRONIX Field Engineer or representative.

All requests for repair and replacement parts should be directed to the TEKTRONIX Field Office or representative in your area. This will assure you the fastest possible service. Please include the instrument Type Number or Part Number and Serial Number with all requests for parts or service.

Specifications and price change privileges reserved.

Copyright © 1973 by Tektronix, Inc., Beaverton, Oregon. Printed in the United States of America. All rights reserved. Contents of this publication may not be reproduced in any form without permission of Tektronix, Inc.

U.S.A. and Foreign TEKTRONIX products covered by U.S. and foreign patents and/or patents pending.

TEKTRONIX is a registered trademark of Tektronix, Inc.

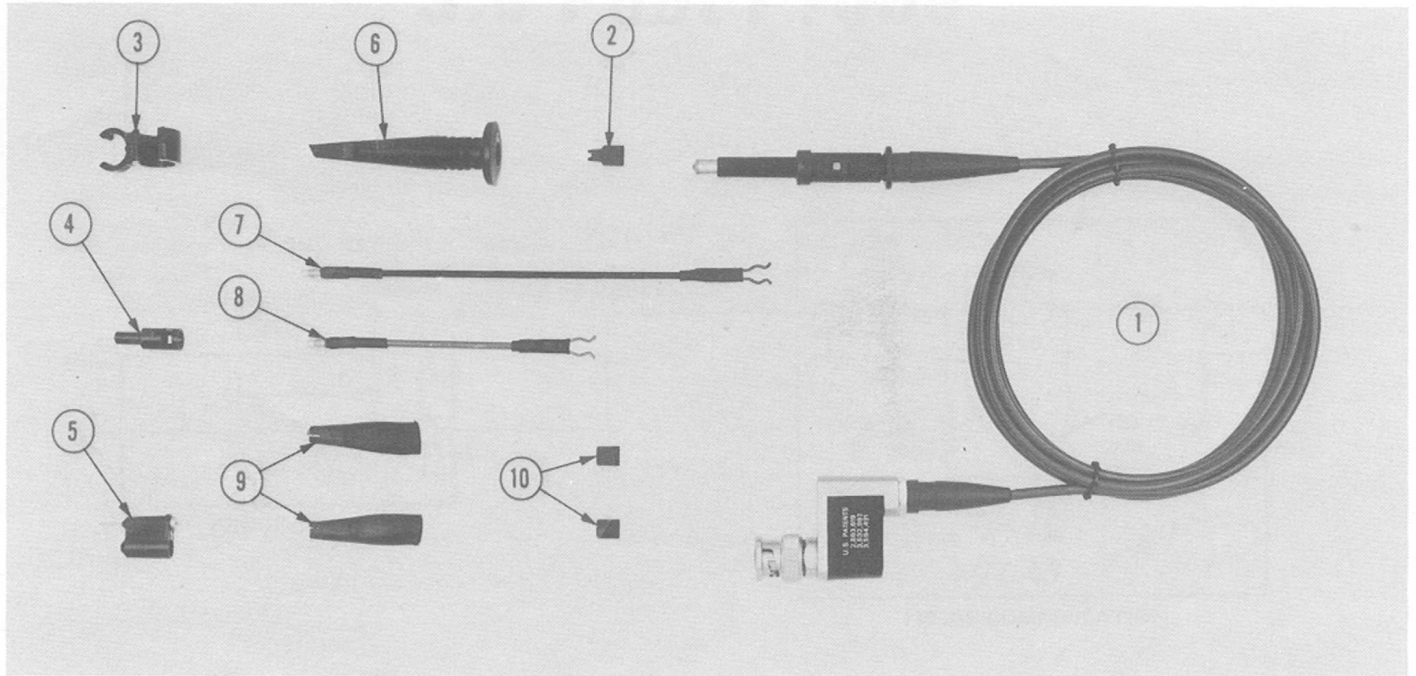

Fig. 1. P6054A Probe and Standard Accessories.

Fig. & Index No.	Tektronix Part No.	Serial/Model No.		Qty	Name & Description	Mfr	
		Eff	Dscont			Code	Mfr Part Number
1-	010-6054-11			1	PROBE PACKAGE:P6054A, 3.50 FOOT	80009	010-6054-11
	010-6054-13			1	PROBE PACKAGE:P6054A, 6 FOOT	80009	010-6054-13
	010-6054-15			1	PROBE PACKAGE:P6054A, 9 FOOT	80009	010-6054-15
	- - - - -			-	PROBE PACKAGE INCLUDES:		
-1	010-6054-10			1	PROBE:P6054A, 3.50 FOOT W/IC TIP	80009	010-6054-10
	010-6054-12			1	PROBE:P6054A, 6 FOOT W/IC TIP	80009	010-6054-12
	010-6054-14			1	PROBE:P6054A, 9 FOOT W/IC TIP	80009	010-6054-14
-2	015-0201-00			1	TIP,PROBE:IC TEST (INCLUDED W/PROBE)	80009	015-0201-00
-3	352-0234-00			1	HOLDER,PROBE:PLASTIC	80009	352-0234-00
-4	206-0114-00			1	TIP,PROBE:HOOK	80009	206-0114-00
-5	013-0085-00			1	TIP,PROBE:GND	80009	013-0085-00
-6	013-0107-03			1	TIP,PROBE:RETRACTABLE HOOK ASSY W/FLANGE	80009	013-0107-03
-7	175-0124-01			1	LEAD,ELECTRICAL:GROUND, 5 INCHES LONG	80009	175-0124-01
-8	175-0263-01			1	LEAD,ELECTRICAL:GROUND, 3 INCHES LONG	80009	175-0263-01
-9	344-0046-00			2	CLIP,ELECTRICAL:ALLIGATOR TYPE W/COVER	80009	344-0046-00
-10	166-0404-01			2	INS,SLEEVE ELEC:PLASTIC	80009	166-0404-01



# P6054A PROBE

## CHARACTERISTICS

### Description

The P6054A Probe is a miniature, passive, fast-rise, 10X attenuation probe designed primarily for use with Tektronix oscilloscopes, such as 453, 453A, 454, 454A, and the 10A2A Plug-In Unit. The probe can be compensated for use with other oscilloscopes or plug-in units that have an input capacitance of 15 to 24 pF (paralleled by 1 M $\Omega$ ).

The probe consists of a small-diameter probe body assembly (especially useful in compact circuitry), a 3.5-foot, 6-foot, 9-foot cable, and a compensating box with a BNC connector.

A ground reference pushbutton on the body of the probe permits the user to obtain a ground reference or to determine which trace of a multitrace display includes the signal from the P6054A Probe.

The compensating box houses a compensation network that provides optimum transient response when the probe is used with wideband oscilloscopes. The probe can be low-frequency compensated to match the input of the associated instrument by adjusting the variable capacitor through the hole in the compensating box housing. Internal calibration adjustments provide high-frequency compensation. A snap-on cover gives access to the internal adjustments.

## SPECIFICATIONS

### Electrical

**Attenuation:** 10X within 3%, including 1 M $\Omega$ ,  $\pm$ 2% amplifier input.

**Input Resistance:** 10 M $\Omega$  within 2%, including input R of amplifier. See X<sub>p</sub>, R<sub>p</sub> vs. Frequency curves.

**Input Capacitance:** 3.5-foot cable; 9.5 pF,  $\pm$ 0.5 pF. 6-foot cable; 12.5 pF,  $\pm$ 0.5 pF. 9-foot cable, 13.5 pF,  $\pm$ 0.5 pF.

**Compensation Range:** 15 pF or less to at least 24 pF.

**Bandwidth (–3 dB):** (With an oscilloscope having a bandwidth of  $\geq$ 150 MHz) 3.5-foot and 6-foot cables,  $\approx$ 150 MHz. 9-foot cable,  $\approx$ 115 MHz.

**Maximum Input Voltage:** 500 V (DC + peak AC), derated with frequency. See derating curves.

### General

**Weight:** With 3.5-foot cable,  $\approx$ 5 ounces (141.8 grams) net. Shipping,  $\approx$ 12 ounces.

With 6-foot cable,  $\approx$ 5.25 ounces (148.8 grams) net. Shipping,  $\approx$ 12.5 ounces.

With 9-foot cable,  $\approx$ 5.5 ounces (155.9 grams) net. Shipping,  $\approx$ 13 ounces.

### Dimensions:

**PROBE BODY:**  $\approx$ 3.7 inches (9.4 cm), length;  $\approx$ 0.45 inch (1.1 cm), maximum outside diameter.

**CABLE:** Length;  $\approx$ 3.5 feet (1.1 meter),  $\approx$ 6 feet (1.8 meters), or  $\approx$ 9 feet (2.7 meters) between strain relief bases.

**COMPENSATION BOX:** Length,  $\approx$ 1.7 inches (4.3 cm); Width,  $\approx$ 0.6 inch (1.5 cm); Height,  $\approx$ 1.2 inches (3.0 cm).

### Environmental:

The probe will operate within specifications over the following ranges; Temperature,  $-15^{\circ}\text{C}$  to  $+75^{\circ}\text{C}$ . Altitude, to 15,000 feet.

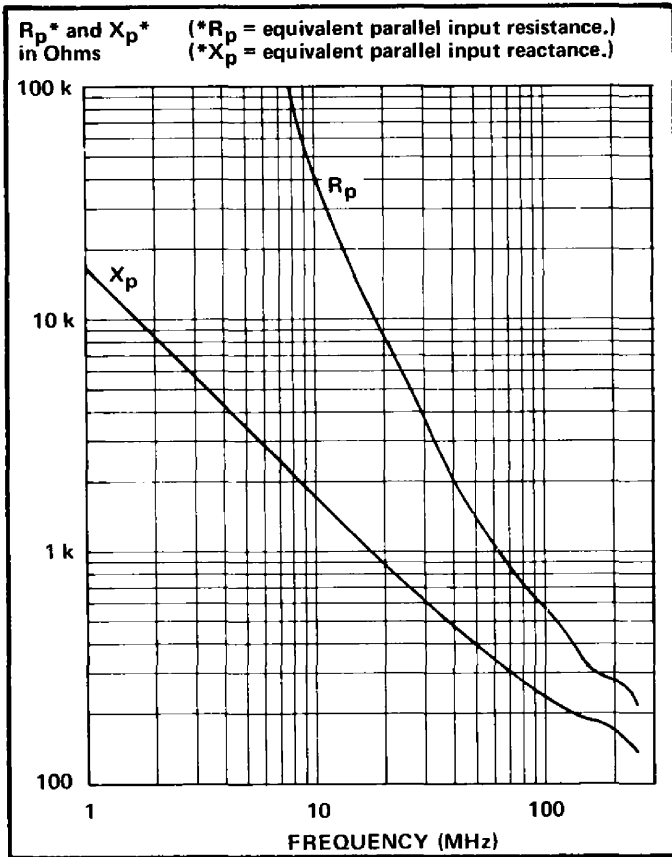

Fig. 2. P6054A Probe (3.5-foot cable), typical  $X_p$ ,  $R_p$  versus frequency curves.

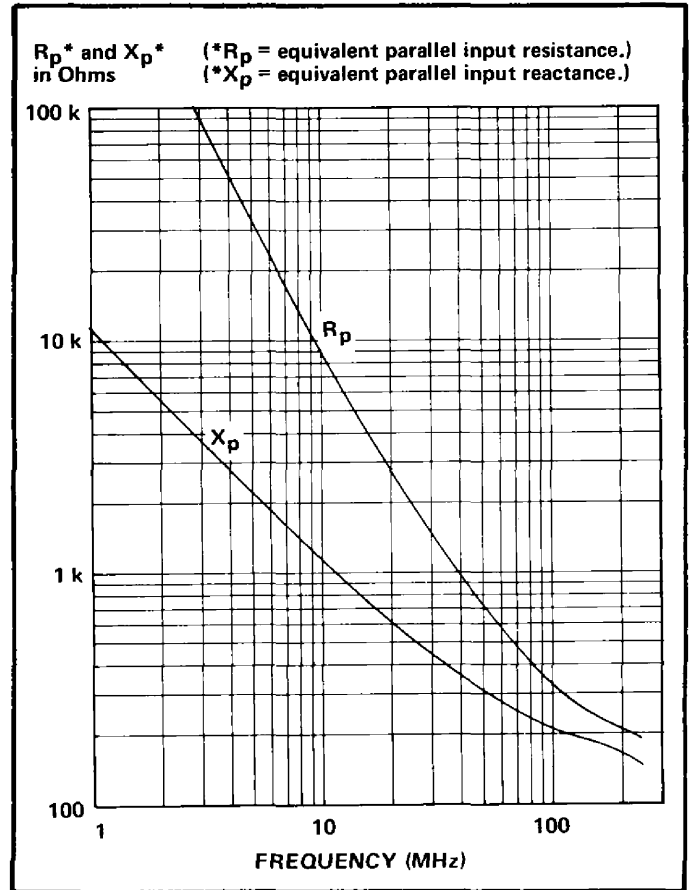

Fig. 4. P6054A Probe (9-foot cable), typical  $X_p$ ,  $R_p$  versus frequency curves.

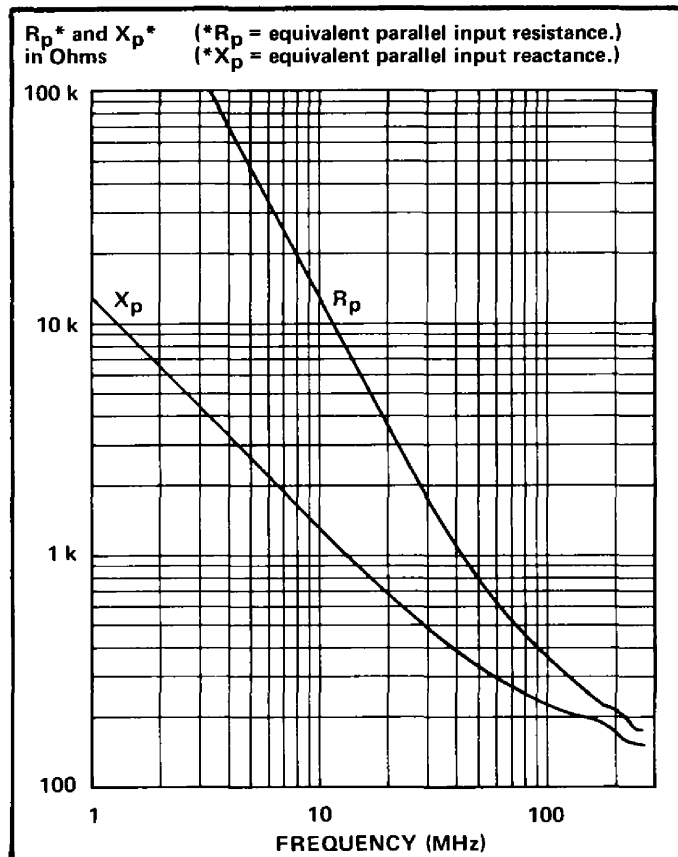

Fig. 3. P6054A Probe (6-foot cable), typical  $X_p$ ,  $R_p$  versus frequency curves.

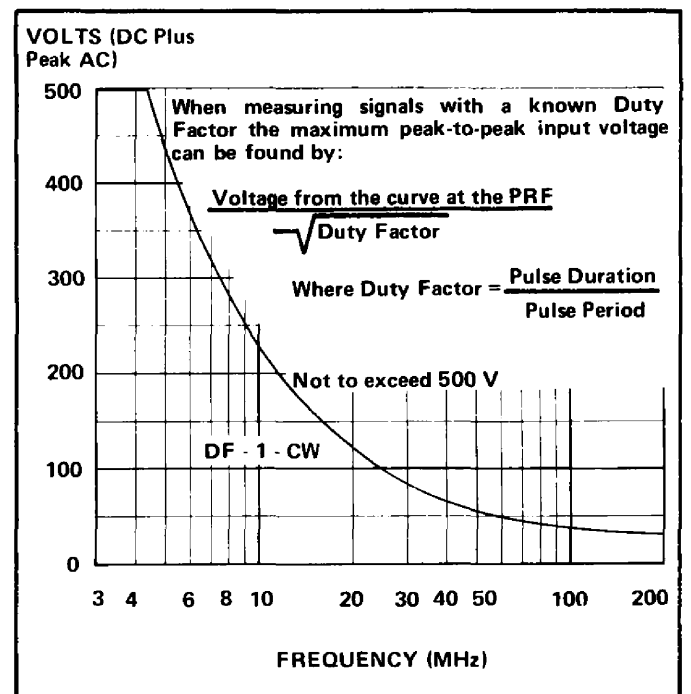

Fig. 5. P6054A Probe, typical voltage rating with frequency curve.

## OPERATING INSTRUCTIONS<sup>1</sup>

## MAINTENANCE

### Probe Compensation

Due to slight variations in the input capacitance between oscilloscope input amplifiers (even on the same type), it is usually necessary to compensate the probe whenever it is transferred from one instrument to another, or from one channel to another of dual (multi-trace) units. Improper compensation will produce waveshape distortion and/or amplitude measurement error of the display. See Compensation Procedure for method of adjustment.

### Maximum Input Voltage

The maximum allowable input voltage of the P6054A Probe is 500 V (DC + peak AC) at the low-frequency end of its range. As signal frequency increases, input capacitive reactance decreases and the maximum safe input voltage decreases. Fig. 5 shows the typical voltage derating vs. frequency curve.

### Circuit Loading

Although the DC input resistance of the P6054A is 10 M $\Omega$ , it can load any high-impedance circuit it is connected into, and distort the true waveform present. To minimize this loading effect, select the lowest impedance points to check waveforms. As signal frequency increases, the equivalent probe input impedance decreases because of the input capacitance of the probe. Therefore, the probe loading increases with frequency. Figs. 2, 3, and 4 show  $R_p$  and  $X_p$  as a function of frequency. These curves should be referred to when making measurements of AC signals, especially in high-impedance circuits.

### Probe Grounding

A passive probe such as the P6054A is a capacitive divider for high-frequency components. An inductance introduced by a long ground lead will form a series resonant circuit which will "ring" if driven by a signal containing significant frequency components at or above circuit resonance. These oscillations can appear on the oscilloscope display and distort the true waveform.

Ground leads and probe tip connections should be kept as short as possible to minimize chances of "ringing".

<sup>1</sup>Measurement Concept Booklet; Probe Measurements, Tektronix Part Number 062-1120-00 is a recommended treatise on probe use and measurement evaluation.

### General

The P6054A Probe is built to withstand normal usage, but may be damaged if treated carelessly. Avoid kinking or straining the cable or subjecting the probe to extreme environmental conditions. When not in use, the probe should be stored in a drawer, or supported by the plastic holder supplied with the probe.

If the probe is damaged, replacement parts are available through your local Tektronix Field Office or representative. The mechanical and electrical parts lists at the rear of this manual provide the Tektronix part numbers and descriptions for the components.

Substitution of non-standard parts is not advisable if the original performance is to be restored. Even shortening the cable by more than a few percent will have a noticeable effect on the transient response of the probe. The resistive center conductor has been specifically selected for critical dampening of reflections that would otherwise exist.

### Connector Replacement

1. Remove the snap-fit cover on the compensation box. See Fig. 6 for instructions.
2. Unsolder the center conductor from the connector to the circuit board.

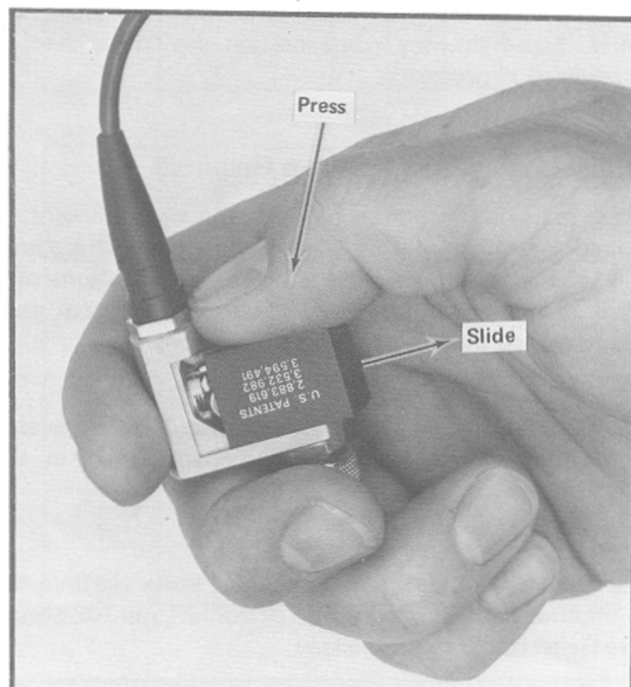

Fig. 6. Removal of compensation box cover.

## P6054A Probe

3. Loosen the 7/16-inch nut (part of the connector), unscrew, and remove the connector.

4. Install the new connector, performing steps 1 through 3 above in reverse order.

## Cable Replacement

1. Remove the snap-fit cover on the compensation box.

2. Unsolder the cable center conductor from the circuit board.

3. Remove the 7/16-inch cable bushing from the compensation box.

4. Unscrew the probe body from the cable.

5. Unsolder the cable center conductor from the resistor/capacitor lead (located in the probe head). Also unsolder the ground reference contact.

6. Pull the resistor/capacitor assembly from the holder.

7. Insert the resistor/capacitor assembly into the holder of the new probe cable and re-assemble the probe, reversing the procedure given in steps 1 through 6.

## COMPENSATION PROCEDURE

### Introduction

The P6054A Probe is a stable device and does not require frequent re-calibration. However, if the probe is transferred from one instrument or input channel to another, the low-frequency compensation will usually require readjustment. If the probe is to be used in observing or measuring sine-waves or pulses with frequency components above 3 or 4 MHz, high-frequency compensation should be checked and adjusted as necessary.

### Equipment and Test Fixtures Required

The following list of equipment, or its equivalent, is required to perform the complete compensation procedure. Some of the recommended equipment specifications may exceed requirements; however, substitute equipment must meet or exceed these minimum specifications.

1. Test oscilloscope with 150 MHz or greater bandwidth. A Tektronix Type 454A Oscilloscope is used in this procedure.

2. Pulse or Square Wave Generator; pulse risetime  $\leq 1$  ns, amplitude 0.5 V into 50  $\Omega$ ; Tektronix Type 106 Square Wave Generator is recommended.

3. Cable, 5 ns, 50  $\Omega$  coaxial Type RG58C/U with GR connectors; Tektronix Part No. 017-0502-00.

4. Attenuator, 10X, 50  $\Omega$  with GR connectors; Tektronix Part No. 017-0078-00.

5. Termination, 50  $\Omega$  thru-line, GR-to-BNC male; Tektronix Part No. 017-0083-00.

6. Termination Adapter, 50  $\Omega$  Probe tip-to-GR; Tektronix Part No. 017-0088-00.

7. Adapter, Probe tip-to-BNC male; Tektronix Part No. 013-0084-01.

### Preliminary Procedure

a. Install the P6054A Probe on the Ch 1 Input of the test oscilloscope.

b. Turn the test oscilloscope and associated test equipment power on and allow enough warmup time for the equipment to stabilize.

c. Set the test oscilloscope Volts/Div to 20 mV and the Time/Div to 1 ms.



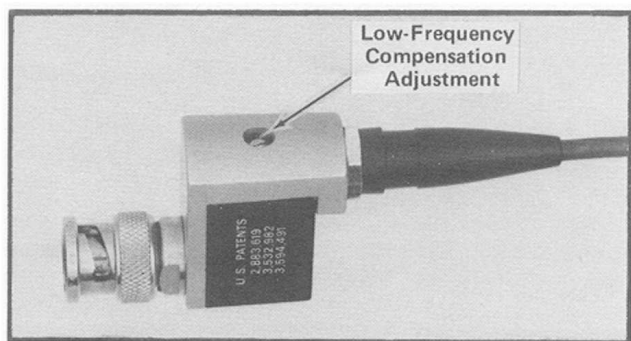

Fig. 7. Location of probe low-frequency compensation adjustment.

## 1. Adjust Low-Frequency Compensation

a. Connect the probe tip to the test oscilloscope 1 V Cal output, using the Probe tip-to-BNC Adapter.

b. Set the test oscilloscope triggering controls for a stable triggered display. The display should be approximately ten cycles of square wave with an amplitude of 5 divisions.

c. Adjust the probe compensation (C8, see Fig. 7) for optimum flat top on the square wave. Fig. 8 illustrates the correct and incorrect settings of the adjustment.

## 2. Check/Adjust High-Frequency Compensation

Typical Response—Pulse waveform distortion (aberrations) should not exceed +3%, -3%, or 3% P-P.

a. Disconnect the P6054A Probe from the test oscilloscope.

b. Connect the +Output of the Type 106 Square Wave Generator through a 5 ns, 50  $\Omega$  cable, a GR 10X attenuator, and a 50  $\Omega$  thru-line termination with GR-to-BNC connectors to the CH 1 Input connector of the test oscilloscope.

c. On the Type 106, set the Repetition Rate Range switch to 100 kHz, the Multiplier control to 1, and the Hi Amplitude/Fast Rise switch to Fast Rise.

d. Set the test oscilloscope Time/Div to 0.05  $\mu$ s. If the test oscilloscope is a 454A, set the Volts/Div to 10 mV. For the 453, 453A, and 454, set the Volts/Div to 20 mV.

e. Adjust the +Transition Amplitude control on the Type 106 for a pulse amplitude of 5 divisions.

f. Note the pulse shape and aberrations.

g. Remove the 50  $\Omega$  cable, 10X attenuator, and termination from the Type 106 and the test oscilloscope. Install the P6054A Probe on the Ch 1 Input connector.

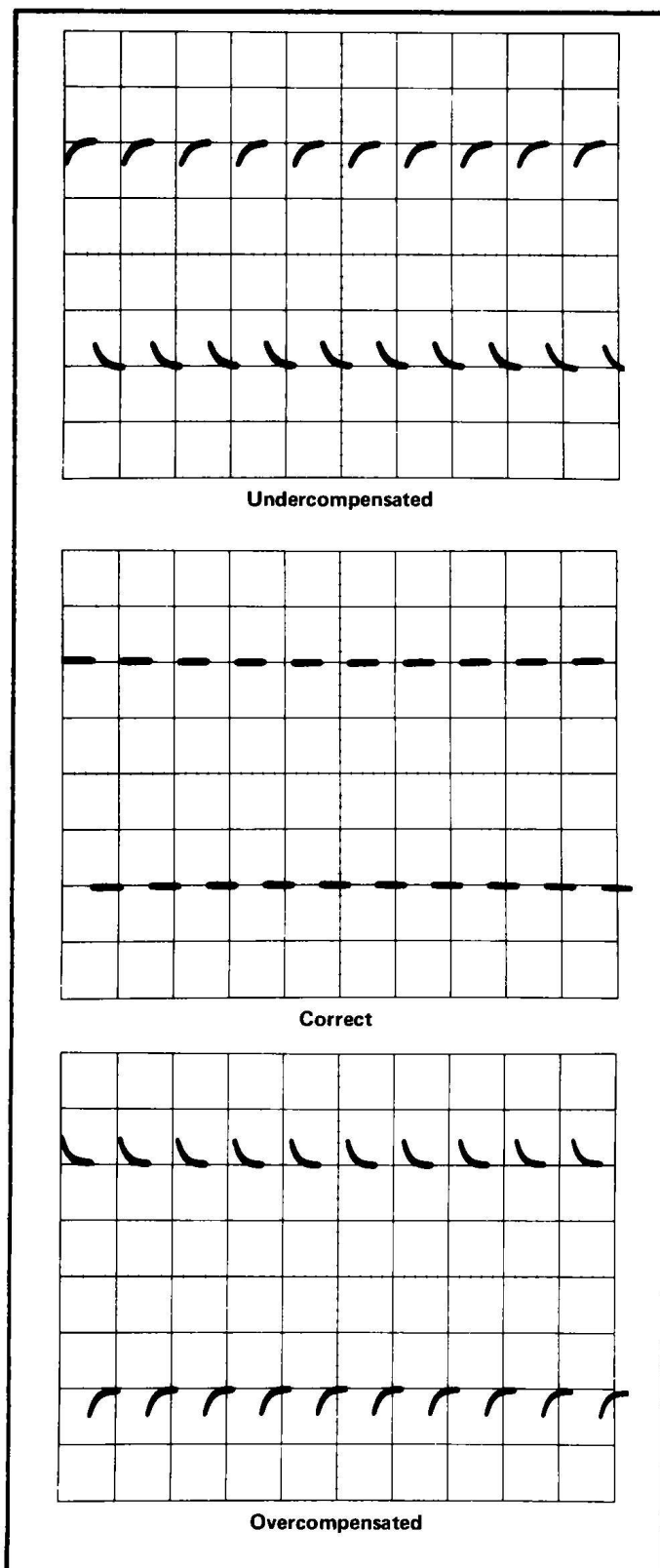

Fig. 8. Probe low-frequency compensation.

## P6054A Probe

h. Connect the probe tip to the +Output of the Type 106, using a Probe tip-to-GR Termination Adapter (017-0088-00).

i. Check the high-frequency response by comparing the probe/oscilloscope pulse response against the display noted in step f. Aberrations from the reference response should not exceed +3%, -3%, or 3% P-P of the pulse amplitude (or 0.15 div).

j. If aberrations are excessive, proceed as follows:

1) Remove the compensation box cover. (See Fig. 6 for directions).

2) Adjust R5, R6, and R9 for the best overall flat response. See Fig. 9 for adjustment locations.

3) Adjust C6 for the best corner response (without ringing).

4) Repeat parts 2 and 3 as necessary for best waveform.

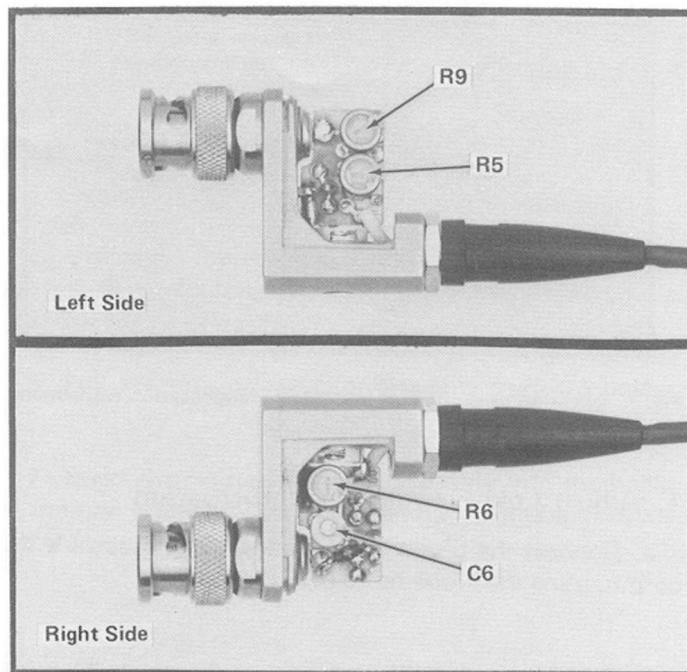

Fig. 9. Location of high-frequency compensation adjustments.

5) Recheck the waveform with the compensation box cover installed. Perform adjustments as necessary to obtain the correct waveform after the cover is installed.

This completes the compensation procedure for the P6054A Probe.

# REPLACEABLE PARTS LIST

## INDENTATION SYSTEM

This mechanical parts list is indented to indicated item relationships. Following is an example of the indentation system used in the Description column.

*Assembly and/or Component*  
*Detail Part of Assembly and/or Component*  
*Attaching parts for Detail Part*  
*Parts of Detail Part*  
*Attaching parts for Parts of Detail Part*  
*Attaching parts for Assembly and/or Component*

Attaching Parts always appear in the same indentation as the item it mounts, while the detail parts are indented to the right. Indented items are part of, and included with, the next higher indentation.

**Attaching parts must be purchased separately, unless otherwise specified.**

## PARTS ORDERING INFORMATION

Replacement parts are available from or through your local Tektronix, Inc. Field Office or representative.

Changes to Tektronix instruments are sometimes made to accommodate improved components as they become available, and to give you the benefit of the latest circuit improvements developed in our engineering department. It is therefore important, when ordering parts, to include the following information in your order: Part number, instrument type or number, serial number, and modification number if applicable.

If a part you have ordered has been replaced with a new or improved part, your local Tektronix, Inc. Field Office or representative will contact you concerning any change in part number.

Change information, if any, is located at the rear of this manual.

## SPECIAL NOTES AND SYMBOLS

X000	Part first added at this serial number
00X	Part removed after this serial number

# CROSS INDEX

## MFR. CODE NUMBER TO MANUFACTURER

MFR.CODE	MANUFACTURER	ADDRESS	CITY,STATE,ZIP
72982	Erie Technological Products, Inc.	644 W. 12th St.	Erie, PA 16512
73899	JFD Electronics Corp.	15th at 62nd St.	Brooklyn, NY 11219
80009	Tektronix, Inc.	P. O. Box 500	Beaverton, OR 97005
80294	Bourns, Inc.	1200 Columbia Ave.	Riverside, Ca 92507

## SYMBOLS and REFERENCE DESIGNATORS

Electrical components shown on the diagrams are in the following units unless noted otherwise:

Capacitors= Values one or greater are in picofarads (PF).

Values less than one are in microfarads (UF).

Resistors= Ohms.

The following prefix letters are used as reference designators to identify components or assemblies on the diagrams.

C Capacitor, fixed or variable  
 L Inductor, fixed or variable  
 LR Inductor/resistor combination  
 R Resistor, fixed or variable

## ABBREVIATIONS

ASSY	Assembly	ELEC	electric	RCPT	receptical
CAP	Capacitor	FXD	fixed	RES	Resistor
CER	Ceramic	GND	grounding	TECH	technical
CKT	Circuit	HSG	housing	V	volt
COMP	Compensator	IC	Integrated circuit	VAR	variable
CONN	Connector	MTG	mounting	W	watt
DI	Dielectric	NON WIR	not wire wound	W/	with

# ELECTRICAL PARTS LIST

## 3.5 Foot Probe

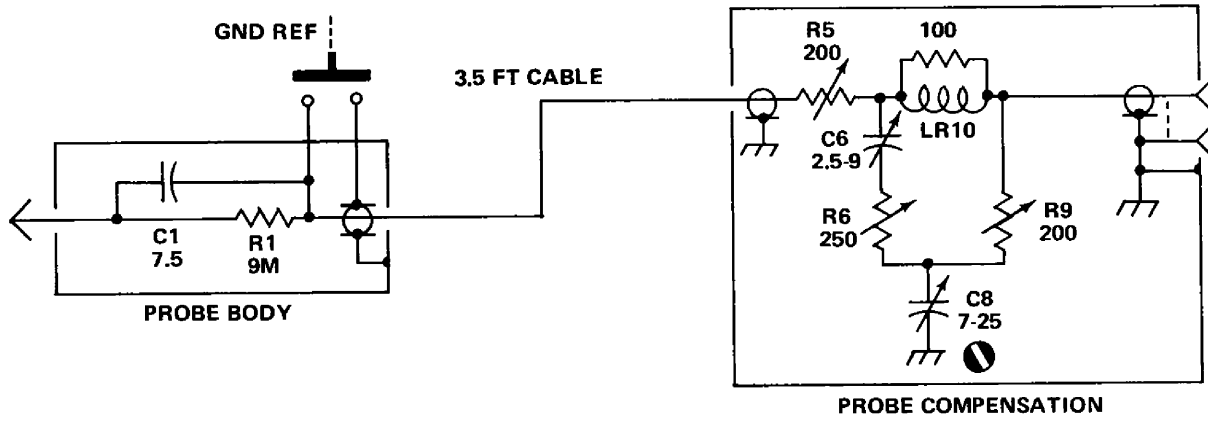

### 3.5 FOOT PROBE

Ckt No.	Tektronix Part No.	Serial/Model No. Eff	Dscont	Name & Description	Mfr Code	Mfr Part Number
C1	- - - - - <sup>1</sup>			CAP.,FXD,CER DI:7.5PF, 500V		
C6	281-0122-00			CAP.,VAR,CER DI:2.5-9PF, 100V	72982	518-000A2.59
C8	281-0160-00			CAP.,VAR,CER DI:7-25PF, 350V	73899	DVJ539
LR10	108-0757-00			COIL,FXD:66NH, ON 100 OHM, 5%, 0.125W, RES.	80009	108-0757-00
R1	- - - - - <sup>1</sup>			RES.,FXD,FILM:9M OHM, 0.25W		
R5	311-0605-01			RES.,VAR, NONWIR:200 OHM, 10%, 0.5W	80294	3326H-K28-201
R6	311-0978-01			RES.,VAR, NONWIR:250 OHM, 10%, 0.5W	80294	3326H-K28-251
R9	311-0605-01			RES.,VAR, NONWIR:200 OHM, 10%, 0.5W	80294	3326H-K28-201

<sup>1</sup>Available as assembly 206-0196-00 only.

# ELECTRICAL PARTS LIST

## 6 Foot Probe

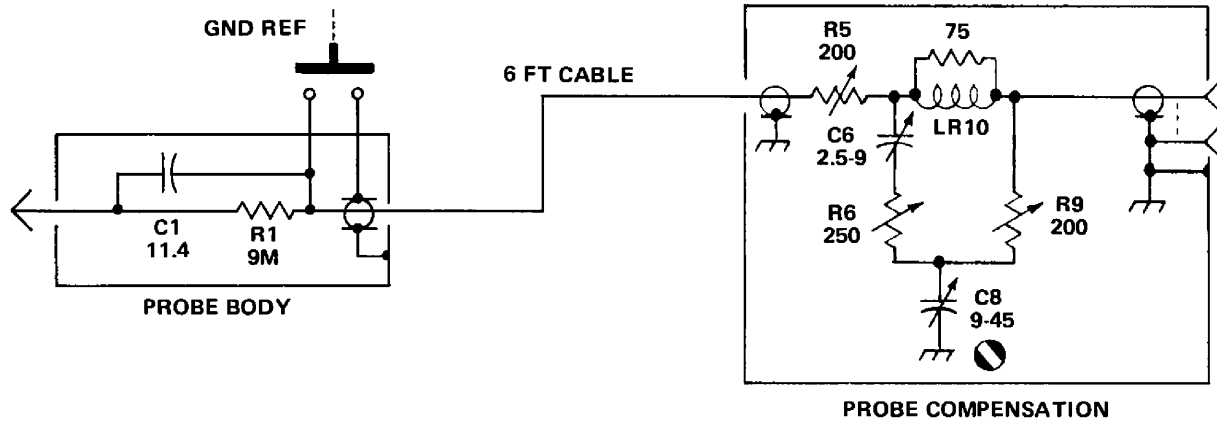

### 6 FOOT PROBE

Ckt No.	Tektronix Part No.	Serial/Model No. Eff	Dscont	Name & Description	Mfr Code	Mfr Part Number
C1	- - - - - <sup>1</sup>			CAP.,FXD,CER DI:11.4PF, 500V		
C6	281-0122-00			CAP.,VAR,CER DI:2.5-9PF, 100V	72982	518-000A2.59
C8	281-0167-00			CAP.,VAR,CER DI:9-45PF, 200V	73899	DVJ-533
LR10	108-0602-00			COIL,FXD:60NH, ON 75 OHM, 5%, 0.125W, RES.	80009	108-0602-00
R1	- - - - - <sup>1</sup>			RES.,FXD,FILM:9M OHM, 0.25W		
R5	311-0605-01			RES.,VAR,NONWIR:200 OHM, 10%, 0.5W	80294	3326H-K28-201
R6	311-0978-01			RES.,VAR,NONWIR:250 OHM, 10%, 0.5W	80294	3326H-K28-251
R9	311-0605-01			RES.,VAR,NONWIR:200 OHM, 10%, 0.5W	80294	3326H-K28-201

<sup>1</sup>Available as assembly 206-0197-00 only.

# ELECTRICAL PARTS LIST

## 9 Foot Probe

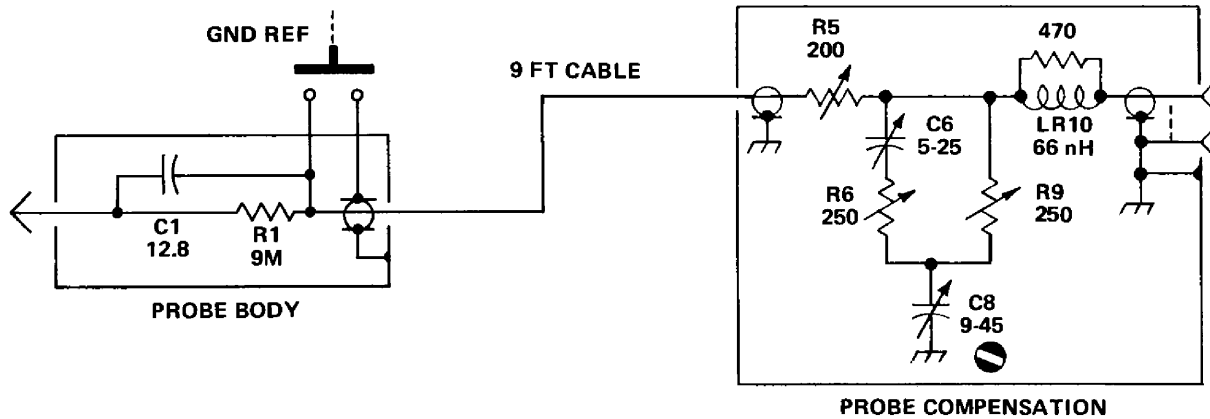

### 9 FOOT PROBE

Ckt No.	Tektronix Part No.	Serial/Model No. Eff	Model No. Dscont	Name & Description	Mfr Code	Mfr Part Number
C1	- - - - - <sup>1</sup>			CAP.,FXD,CER DI:12.8PF, 500V		
C6	281-0123-00			CAP.,VAR,CER DI:5-25PF, 100V	72982	518-000-A5-25
C8	281-0167-00			CAP.,VAR,CER DI:9-45PF, 200V	73899	DVJ-533
LR10	108-0677-00			COIL,FXD:66NH, ON 470 OHM, 5%, 0.125W, RES.	80009	108-0677-00
R1	- - - - - <sup>1</sup>			RES.,FXD,FILM:9M OHM, 0.25W		
R5	311-0605-01			RES.,VAR,NONWIR:200 OHM, 10%, 0.5W	80294	3326H-K28-201
R6	311-0978-01			RES.,VAR,NONWIR:250 OHM, 10%, 0.5W	80294	3326H-K28-251
R9	311-0978-01			RES.,VAR,NONWIR:250 OHM, 10%, 0.5W	80294	3326H-K28-251

<sup>1</sup>Available as assembly 206-0198-00 only.

# MECHANICAL PARTS LIST

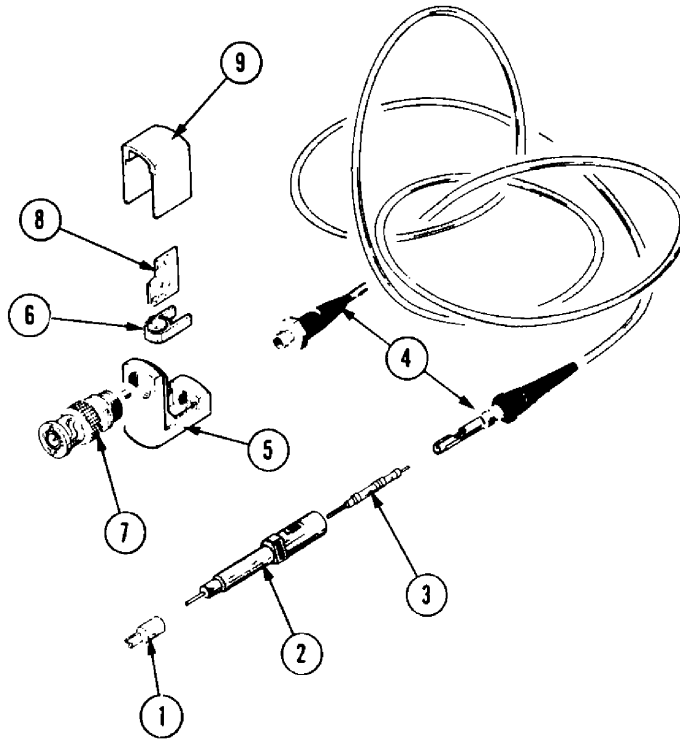

Fig. & Index No.	Tektronix Part No.	Serial/Model No.		Qty	1	2	3	4	5	Name & Description	Mfr Code	Mfr Part Number
		Eff	Dscont									
	010-6054-10			1						PROBE:P6054A, 3.50 FOOT	80009	010-6054-10
	010-6054-12			1						PROBE:P6054A, 6 FOOT	80009	010-6054-12
	010-6054-14			1						PROBE:P6054A, 9 FOOT	80009	010-6054-14
	- - - - -			-						PROBE INCLUDES:		
-1	015-0201-00			1						TIP,PROBE:IC TEST	80009	015-0201-00
-2	204-0579-03			1						BODY ASSEMBLY:PROBE	80009	204-0579-03
-3	206-0196-00			1						ATTENUATOR ASSY:(FOR 3.50 FOOT ONLY)	80009	206-0196-00
	206-0197-00			1						ATTENUATOR ASSY:(FOR 6 FOOT ONLY)	80009	206-0197-00
	206-0198-00			1						ATTENUATOR ASSY:(FOR 9 FOOT ONLY)	80009	206-0198-00
-4	175-1173-01			1						CABLE ASSEMBLY:(FOR 3.50 FOOT ONLY)	80009	175-1173-01
	175-1383-00			1						CABLE ASSEMBLY:(FOR 6 FOOT ONLY)	80009	175-1383-00
	175-1400-00			1						CABLE ASSEMBLY:(FOR 9 FOOT ONLY)	80009	175-1400-00
-5	426-0690-01			1						FRAME,HSG ASSY:COMPENSATION BOX	80009	426-0690-01
-6	354-0396-00			1						RING,CAP.,MTG:	80009	354-0396-00
-7	131-0602-00			1						CONN,RCPT,ELEC:FEMALE,BNC	80009	131-0602-00
-8	670-0983-01			1						CKT BOARD ASSY:(FOR 3.50 FOOT ONLY)	80009	670-0983-01
	670-0983-00			1						CKT BOARD ASSY:(FOR 6 FOOT ONLY)	80009	670-0983-00
	670-0996-00			1						CKT BOARD ASSY:(FOR 9 FOOT ONLY)	80009	670-0996-00
-9	200-1158-13			1						COVER,COMP:(FOR 3.50 FOOT ONLY)	80009	200-1158-13
	200-1158-11			1						COVER,COMP:(FOR 6 FOOT ONLY)	80009	200-1158-11
	200-1158-12			1						COVER,COMP:(FOR 9 FOOT ONLY)	80009	200-1158-12
	070-1595-00			1						MANUAL,TECH:(NOT SHOWN)	80009	070-1595-00